

OFFICIAL

Pavement Marking Manual

April 2024



Government of South Australia
Department for Infrastructure
and Transport

Build.
Move.
Connect.

Disclaimer

While every reasonable effort has been made to ensure that this document is correct at the time of publication, the Minister for Infrastructure and Transport, its agencies, instrumentalities, employees and contractors disclaim any and all liability to any person in respect to anything or the consequence of anything done or omitted to be done in reliance upon the whole or any part of this document.

Publication details

Document information

Title	Pavement Marking Manual
Owner	Traffic Engineering Standards
KNet reference	2244015

Change history

Version number	Date changed	Nature of amendment
7	11 November 2021	Amendments in red and additional diagrams
8	2 April 2024	Amendments in red and additional diagrams including updated references to AS 1742.2 (2022) and pavement marking designations, zebra crossing dimensions updated to reflect DIT Supplement to AS 1742.10; Electric Vehicle parking marking symbol added; treatment of wide pavement areas and wide aprons added; median turning bay guidance added; use of enhanced lines at interchanges added; barrier lines at rest areas added.

Approvals record

Approver	Position	Date	Signature
Stephen Pascale	Manager, Traffic Services	27 March 2024	Digital Approval 35180

We acknowledge the Traditional Custodians of the Country throughout South Australia and recognise their continuing connection to land and waters. We pay our respects to the diversity of cultures, significance of contributions and to Elders past, present and emerging.



Contents

1. Introduction	3
1.1 SCOPE	3
1.2 LEGAL REQUIREMENTS	3
1.3 GENERAL ATTRIBUTES	3
1.3.1 PURPOSE	3
1.3.2 REMOVAL OF MARKINGS	3
1.3.3 LIMITATIONS	4
1.3.4 REFLECTORISATION	4
1.3.5 ANTI-SKID TREATMENT	4
1.3.6 MATERIALS	4
1.3.7 COLOURS	5
1.3.8 DISTINCTIVE PAVEMENT MARKING COLOURS AND TEXTURE	5
1.3.9 OFF STREET PARKING AREAS	5
1.3.10 PAVEMENT MARKING MAINTENANCE	5
1.3.11 REFERENCE ACRONYMS WITHIN THIS MANUAL	6
2. Types of Markings	7
2.1 DESCRIPTION OF MARKINGS	8
2.1.1 LONGITUDINAL LINES	8
2.1.2 TRANSVERSE LINES	12
2.1.3 PARKING CONTROL LINES	14
2.1.4 NO PEDESTRIAN ZONE (OFF STREET PARKING AREAS ONLY)	15
2.1.5 LONGITUDINAL LINES AT RURAL AND URBAN INTERSECTIONS	16
2.1.6 DIAGONAL STRIPES AND CHEVRON MARKINGS	19
2.1.7 ARROWS	20
2.1.8 MESSAGES AND SYMBOLS	23
2.1.9 RAILWAY LEVEL CROSSING PAVEMENT MESSAGE	35
2.1.10 RAILWAY LEVEL CROSSINGS YELLOW BOX (cross-hatched) MARKINGS	36
2.1.11 ZIGZAG SCHOOL ZONE MARKINGS	37
2.1.12 POINT TO POINT SAFETY CAMERA MARKINGS (STUB LINE)	37
2.1.13 RAISED ROAD PAVEMENT MARKINGS	37
2.1.14 PAVEMENT BARS	38
2.1.15 RAISED PAVEMENT MARKERS	40
2.1.16 DISTINCTIVE COLOURED PAVEMENT AREAS	56
2.1.17 OUTLINES AND PAINTED KERBS	57
2.1.18 BARRIER LINE INSTALLATION	61
2.1.19 LONGITUDINAL LINE STYLE TRANSITIONS	62
3. Design Guide	65
3.1 SCOPE	65
3.1.1 DIMENSIONING CONVENTION	65
3.2 TRAFFIC CONTROL DRAWINGS AND DESIGN LAYOUTS	65
3.2.1 LONGITUDINAL LINES	65
3.2.2 TRANSVERSE LINES	66
3.2.3 PARKING CONTROL LINES	66

3.2.4	DIAGONAL STRIPES AND CHEVRON MARKINGS	66
3.2.5	ARROWS.....	66
3.2.6	MESSAGES AND SYMBOLS.....	66
3.3	URBAN (Built-up area) TREATMENTS	67
3.3.1	DIVIDING LINES	67
3.3.2	BARRIER LINES	68
3.3.3	DIAGONAL STRIPES AND CHEVRON MARKINGS	69
3.3.4	PAINTED ISLANDS.....	71
3.3.5	CORNER ISLANDS.....	73
3.3.6	CORNER TREATMENT	74
3.3.7	HIGH ANGLE TREATMENT.....	75
3.3.8	DIVERGE AND MERGE TAPER TREATMENTS.....	76
3.3.9	RAISED PAVEMENT MARKERS (RRPMs).....	78
3.3.10	LANE LINES	80
3.3.11	CONTINUITY LINES	86
3.3.12	TURN LANES (PAVEMENT ARROWS).....	89
3.3.13	EDGE LINES	93
3.3.14	ON-STREET PARKING CONTROL	93
3.3.15	PAVEMENT MESSAGES (Including Symbols)	94
3.3.16	KERB EXTENSION MARKINGS	97
3.3.17	STANDARD INTERSECTIONS (Local Urban Roads).....	99
3.3.18	GIVE WAY AND STOP LINE MARKINGS	99
3.3.19	CHANGED PRIORITY.....	102
3.3.20	ROUNDBABOUTS.....	103
3.3.21	SIGNALISED INTERSECTIONS	106
3.3.22	EXPRESSWAYS	117
3.3.23	PATH TREATMENTS - TYPICAL LAYOUTS.....	118
3.3.24	PEDESTRIAN FACILITIES.....	122
3.3.25	SCHOOL ZONES	127
3.3.26	BUS FACILITIES	131
3.3.27	DISTINCTIVE COLOURED PAVEMENT BICYCLE FACILITIES.....	136
3.3.28	OTHER BICYCLE FACILITIES.....	139
3.4	RURAL TREATMENTS.....	140
3.4.1	DIVIDED RURAL ROADS	140
3.4.2	MULTI-LANE UNDIVIDED RURAL ROADS.....	140
3.4.3	DIVIDING LINES ON RURAL ROADS	140
3.4.4	BARRIER LINES ON RURAL ROADS	140
3.4.5	WIDE CENTRE LINE TREATMENTS	141
3.4.6	LANE LINES ON RURAL ROADS.....	141
3.4.7	EDGE LINES ON RURAL ROADS.....	142
3.4.8	OVERTAKING LANE TREATMENTS	148
3.4.9	SLOW VEHICLE TURNOUTS.....	150
3.4.10	REST AREAS	152
3.4.11	STRUCTURES AND OBSTRUCTIONS	156
3.4.12	FLOODWAYS AND CAUSEWAYS	158

1. Introduction

1.1 SCOPE

This manual specifies the lines, patterns, symbols, letters and numerals, pavement bars and markers used in or on roads, road related areas and other places including kerbs, for the purpose of regulating, guiding and warning road users, and provides guidelines for appropriate use.

1.2 LEGAL REQUIREMENTS

Traffic control devices, including pavement markings, must only be used with approval under the *Road Traffic Act 1961* from the Minister for Transport and Infrastructure. The Minister has issued 'Instruments of General Approval' to Councils, the Commissioner of Highways and some other road authorities which grant general approval to use traffic control devices subject to several conditions. One of these conditions is that the installation, alteration and removal of traffic control devices must comply with the *Code of Technical Requirements* (the Code) which forms part of the Department for Infrastructure and Transport's (DIT), *Manual of Legal Responsibilities and Technical Requirements for Traffic Control Devices*.

The Code lists pavement markings which are not to be used in SA and refers the reader to this manual for details of the design of standard pavement markings for use. This manual takes into consideration the relevant Australian Road Rules, Australian Standards, Austroads guidelines and DIT's Operational Instructions and Supplements.

Pavement markings not conforming to this manual and the Code, such as innovative or nonstandard treatments are not authorised to be used under the Instrument of General Approval issued by the Minister. Authorisation for such treatments may only be given by the Manager, Traffic Services, Department for Infrastructure and Transport (DIT), as delegate for the Commissioner of Highways.

1.3 GENERAL ATTRIBUTES

1.3.1 PURPOSE

A system of clear, effective, and consistently applied pavement markings is essential for the proper regulation, warning and guidance of drivers, cyclists, pedestrians, and other road users.

Pavement markings may guide traffic or give advance warning or may impose restrictions which are supported by the *Road Traffic Act*. They may act as a supplement to other traffic control devices or may be used alone to convey certain regulations, warnings and guidance.

It is therefore important to ensure that the use of the markings conforms to the legal requirements mentioned above before they are approved, installed, altered, or removed to avoid possible conflict or confusion, legal or otherwise.

1.3.2 REMOVAL OF MARKINGS

Where traffic conditions are altered and the existing pavement markings no longer apply it is

essential that those markings be removed, covered or obliterated. It is important that the result of removing or covering markings does not leave an impression of the marking on the road surface which may otherwise be interpreted as a marking in any lighting and/or weather conditions. It is also important that any covering material create a surface of a similar skid resistance to that of the surrounding road surface.

In rare cases, redundant pavement markings may be allowed to fade but only when these markings cannot be misinterpreted or otherwise create a confusing message to the road user which may create a safety hazard.

Substantial changes to pavement markings will usually require pavement resurfacing.

1.3.3 LIMITATIONS

Pavement markings have the following limitations:

- a) They may not be clearly visible if the road is wet or dusty, for example near the edge of a median.
- b) They are subject to traffic wear and usually require frequent maintenance.
- c) They can be obscured by traffic.
- d) Their effect on skid resistance requires careful choice of materials and precludes the use of large, marked surface areas.
- e) They cannot be applied to unsealed roads.

Despite these limitations, they have the advantage under favourable conditions of conveying information to the driver without diverting attention from the road.

1.3.4 REFLECTORISATION

All longitudinal and transverse lines except zigzag markings shall be reflectorised. Lane change arrows as shown in **2.1.7.3** and painted kerbs as shown in **2.1.17** shall also be reflectorised.

1.3.5 ANTI-SKID TREATMENT

An anti-skid treatment shall be applied to all markings other than longitudinal lines.

1.3.6 MATERIALS

Road pavements may be marked with paint, thermoplastics, pre-cut sheeting, raised pavement markers (retro-reflective, non-reflective or illuminated) or pavement bars.

For full details refer to DIT's *Master Specification*:

- *RD-LM-C1 Application of Pavement Marking.* <https://www.dit.sa.gov.au?a=553236>
- *RD-LM-C2 Supply & Application of Audio Tactile Line Marking.* <https://www.dit.sa.gov.au?a=553235>

- *RD-LM-S1 Materials for Pavement Marking.* <https://www.dit.sa.gov.au?a=553239>

1.3.7 COLOURS

Pavement markings shall be white unless specified as yellow, blue, green or red. Yellow shall be used on pavement bars and to define tram only lanes and areas where parking/stopping restrictions apply. The colour blue is used for disability access, **green is used for the electric vehicle symbol** and red is used for Bus Only lanes. Raised pavement markers may be white, red or yellow. Blue markers are reserved for locations of fire hydrants.

Black paint may be used in the gaps and around the edges of pavement markings to heighten contrast where a light coloured pavement does not allow adequate marking definition to be obtained. The preferred width of the line is 50 mm.

In situations such as community events on temporarily closed roads, light blue coloured pavement markings (known as honour lines) may be used to define pedestrian boundaries. The preferred width of the line is 50 mm (75 mm max) and shall be non-reflective. It should be painted with one coat and allowed to fade, or removed after the event, to ensure road users are not confused by the markings. These markings are not considered traffic control devices.

Yellow temporary line marking may be used at roadwork sites. Refer to DIT's *SA Standards for Workzone Traffic Management.* <https://www.dit.sa.gov.au?a=316525>

1.3.8 DISTINCTIVE PAVEMENT MARKING COLOURS AND TEXTURE

Distinctive coloured pavements and/or textures maybe used to highlight the road surface in a visual, tactile or audible manner. For the use of these treatments to supplement traffic control devices (e.g. Bus Only areas, bicycle lanes and islands) **see 2.1.16.**

For Audio-Tactile Line marking refer to *OI 2.13* <https://www.dit.sa.gov.au?a=40151> and *Master Specification RD-LM-C2* <https://www.dit.sa.gov.au?a=553236>

For aesthetic pavement marking to supplement streetscape designs, refer *Code of Technical Requirements* section 10.4 'Road Murals'. <https://www.dit.sa.gov.au?a=40255>

NOTE: Road murals shall not be used on CoH roads

1.3.9 OFF STREET PARKING AREAS

Off-street parking areas are road related areas and pavement marking shall be accordance with *AS 1742.11*; *AS 2890.1*; *AS 2890.6*.

1.3.10 PAVEMENT MARKING MAINTENANCE

Refer to *OI 20.1* <https://www.dit.sa.gov.au?a=71793> for maintenance responsibilities.

Also refer to Master Specifications *M13 Maintenance Pavement Marking* <https://www.dit.sa.gov.au?a=658698> and *M16 Application of Pavement Marking.* <https://www.dit.sa.gov.au?a=658701>.

1.3.11 REFERENCE ACRONYMS WITHIN THIS MANUAL

OI	DIT Traffic Engineering Operational Instructions
ARR	Australian Road Rules
GRD	Austrroads Guide to Road Design
GTM	Austrroads Guide to Traffic Management
AS	Australian Standards
MS	DIT Master Specifications
RTA	The Road Traffic Act
The Code	DIT Code of Technical Requirements
CoH	Commissioner of Highways

2. Types of Markings

This Section describes the types of marking used including paint substitutes, pavement bars, raised pavement markers and coloured areas.

It details the actual dimensions and other specification attributes of markings which need not be shown on traffic control and road design drawings.

NOTE: All drawings are not to scale. The reader shall use the dimensions specified throughout the manual. Do not scale off drawings

Installation specification details are provided in the *DIT Master Specification - Roads*. These are mandatory requirements for DIT roads and are recommended requirements for other road authorities. Refer to:

- *RD-LM-C1 Application of Pavement Marking*. <https://www.dit.sa.gov.au?a=553236>
- *RD-LM-C2 Supply & Application of Audio Tactile Line Marking*. <https://www.dit.sa.gov.au?a=553235>
- *RD-LM-S1 Materials for Pavement Marking*. <https://www.dit.sa.gov.au?a=553239>

2.1 DESCRIPTION OF MARKINGS

Reference: AS 1742.2 Figures 5.1, 5.2, 5.3, 5.4, 5.15

2.1.1 LONGITUDINAL LINES

2.1.1.1 Dividing and Barrier lines (separates opposing traffic flows only)

a) **DL1**; Broken Separation (standard)

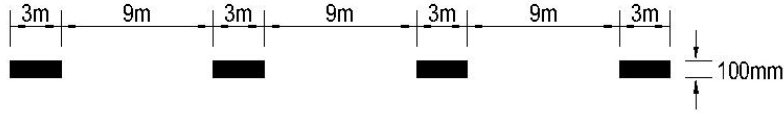

b) **DL2**; Enhanced broken (for multi-lane roads in both directions or single direction including turning lanes)

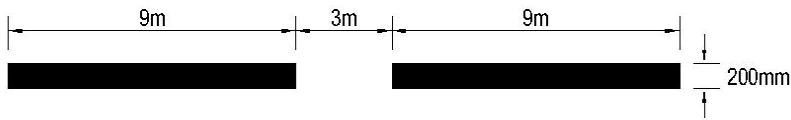

c) **BL3**; Single Unbroken Barrier



d) **BL4**; Enhanced Single Unbroken Barrier (for multi-lane roads in both directions or single direction roads which include a turning lane)



e) **BL1**; Double one-way barrier

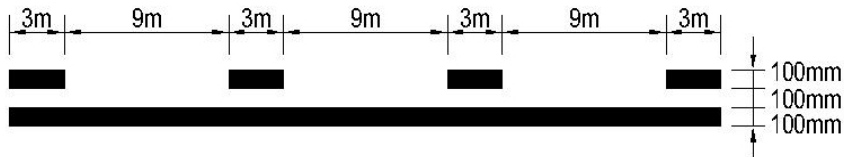

f) **BL2**; Double two-way barrier



NOTE: For justification of the use of a double two-way barrier line or a single unbroken barrier line and when gaps are required, see 2.1.18 Barrier line installation.

LONGITUDINAL LINES (continued)

g) Wide centre line treatment (formerly wide dividing line treatment)

Use of wide centre line treatment (WCLT) is excluded from the *Instrument of General Approval to Councils* and requires approval of CoH or authorised delegate.

Refer to GRD Part 3 Appendix G for design guidance.

Where white Audio Tactile Line Marking (ATLM) is provided next to the line, line width may be reduced to 100 mm. Where continuous black ATLM is installed next to (on the right side) of the line marking, line width shall not be reduced. Also **See 2.1.1.5**

NOTE: WCLT wider than 1.4 m shall be treated as a painted median and overtaking is not permitted. **See 2.1.6.2** for painted median.

i. Wide centre line treatment (double broken)

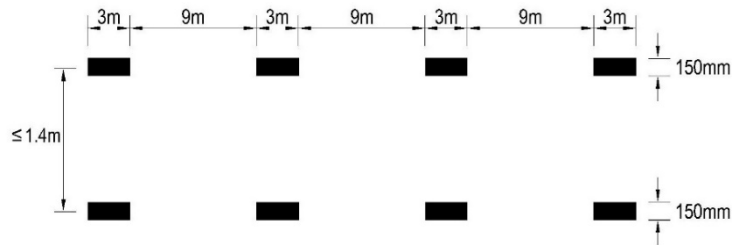

ii. Wide centre line treatment (double broken showing white ATLM)

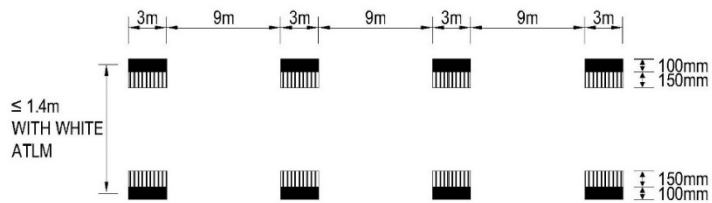

iii. Wide centre line treatment (double one-way)

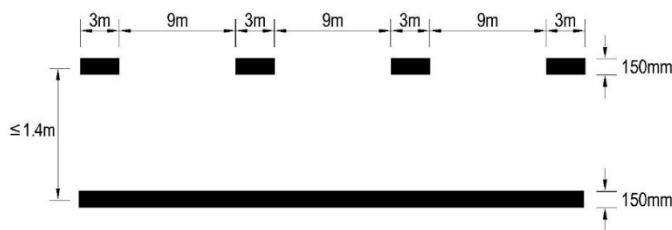

iv. Wide centre line treatment (double two-way)



LONGITUDINAL LINES (continued)

h) Bicycle and shared paths (off road)

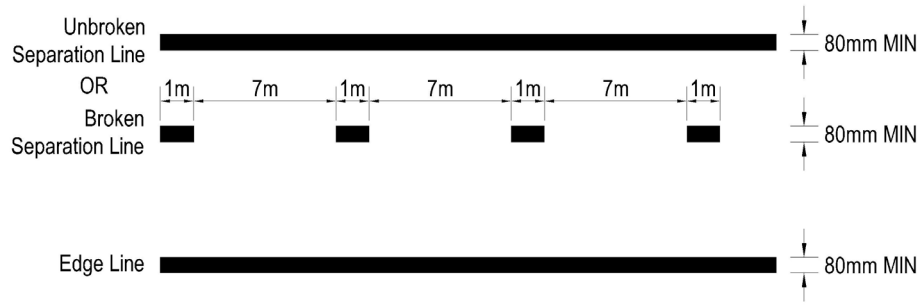

2.1.1.2 Lane lines

a) **LL1; Standard Broken**

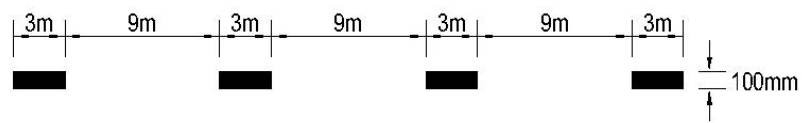

b) **LL4; Unbroken**



c) Simulated lane line – for fog prone areas and lane discipline

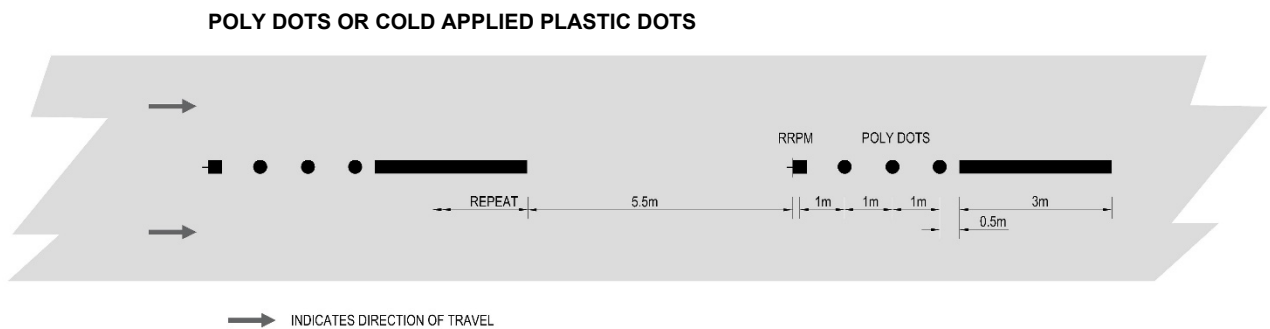

2.1.1.3 Special purpose broken lines

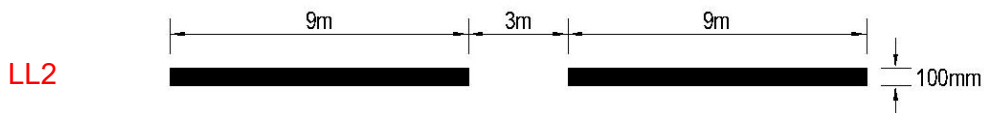

LONGITUDINAL LINES (continued)

2.1.1.4 Edge lines (Unbroken)

- a) **EL1**; Standard: - All roads with sealed shoulders unless (b) below, applies.



- b) **EL2**; Enhanced: - Dukes Highway, Sturt Highway, Riddoch Highway, Pt Wakefield Highway, Augusta Highway, Princes Highway (Murray Bridge to Tailm Bend), all Expressway/Freeway/Motorway type roads and all dual carriageway roads with sealed shoulders > 0.5 m.



NOTE: When transitioning between standard and enhanced, transition in accordance with **2.1.19.4.**

2.1.1.5 ATLM (Audio Tactile Line Marking)

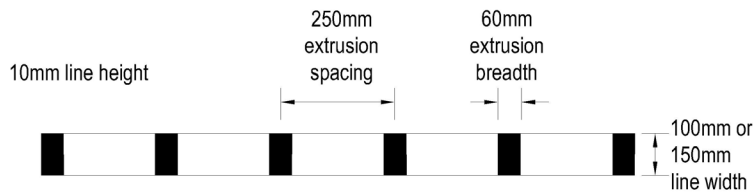

Unless specified otherwise, the pattern must conform to these dimensions. Refer *RD-LM-C2 Supply & Application of Audio Tactile Line Marking* and *OI 2.13*. **Also see 2.1.1.1 g).**

2.1.1.6 Continuity lines

- a) Standard



- b) **CL1**; Enhanced (used in conjunction with 150mm edge lines)

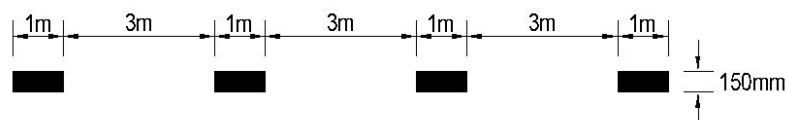

2.1.1.7 Turn lines

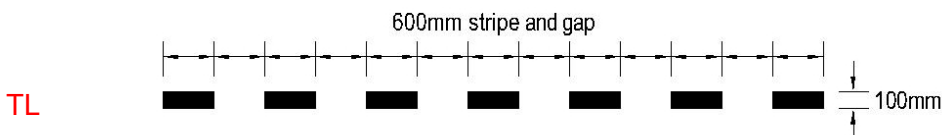

LONGITUDINAL LINES (continued)

2.1.1.8 Outlines

a) Standard (Unbroken)



b) **OL1**; Enhanced (Unbroken)

For roads where 150 mm edge lines are used, **see 2.1.1.4 (b)**



c) Special purpose broken line

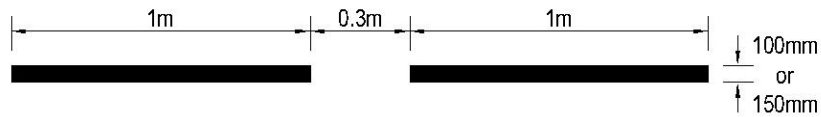

2.1.1.9 Community event pedestrian control line (honour line)



2.1.1.10 Bus only line



2.1.1.11 O-bahn bus guidance line



2.1.2 TRANSVERSE LINES

2.1.2.1 Stop lines

- a) **SL**; Standard (≤ 70 km/h) 
- b) Enhanced (≥ 80 km/h) 
- c) **SLP**; Bicycle & shared paths 

TRANSVERSE LINES (continued)

2.1.2.2 Give way lines

a) **GW**; Standard (≤ 70 km/h)

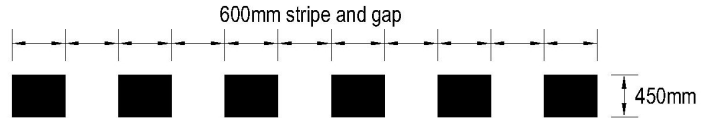

b) Enhanced (≥ 80 km/h)

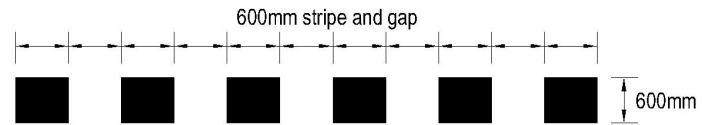

c) Bicycle & shared paths

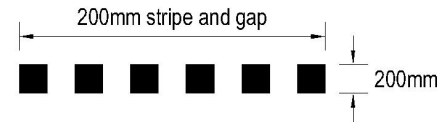

2.1.2.3 Marked Foot Crossing

a) Standard

- For pedestrian actuated crossings, pedestrian crossings at signalised intersections, koala and emu crossings and bicycle crossings.

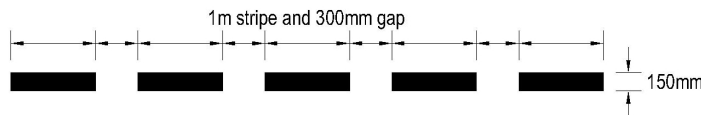

b) Wombat and Zebra crossings

- Wombat - L = 3 m min for off street and 6 m min for on street
- Zebra - L = 3 m min for off street and 6 m min for on street

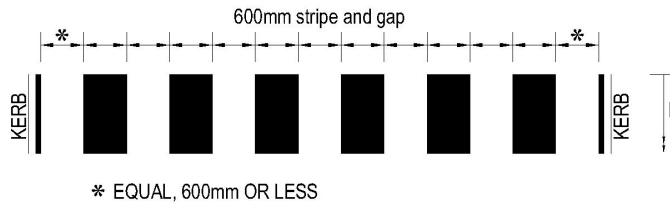

c) Wombat or Zebra crossing on a separated Bike Lane (eg Frome Rd)

- L = 2 m min

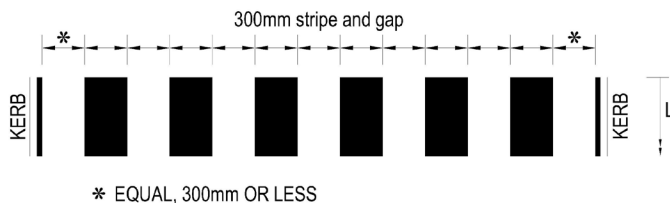

2.1.2.4 Pedestrian holding lines (rail station platforms only)

See 2.1.8.9 for layout of platform markings.

a) Platform edge hazard line



b) Platform 'wait behind' line



TRANSVERSE LINES (continued)

2.1.2.5 Pedestrian kerb ramp access (off street)

Access to kerb ramps between parking spaces may be marked with diagonal stripes to discourage drivers from impeding access to the ramp. Where marked they shall be white.

NOTE: For new works and large car parks, consideration should be given to raised kerb extensions and/or formal pedestrian crossings e.g., wombat crossings.

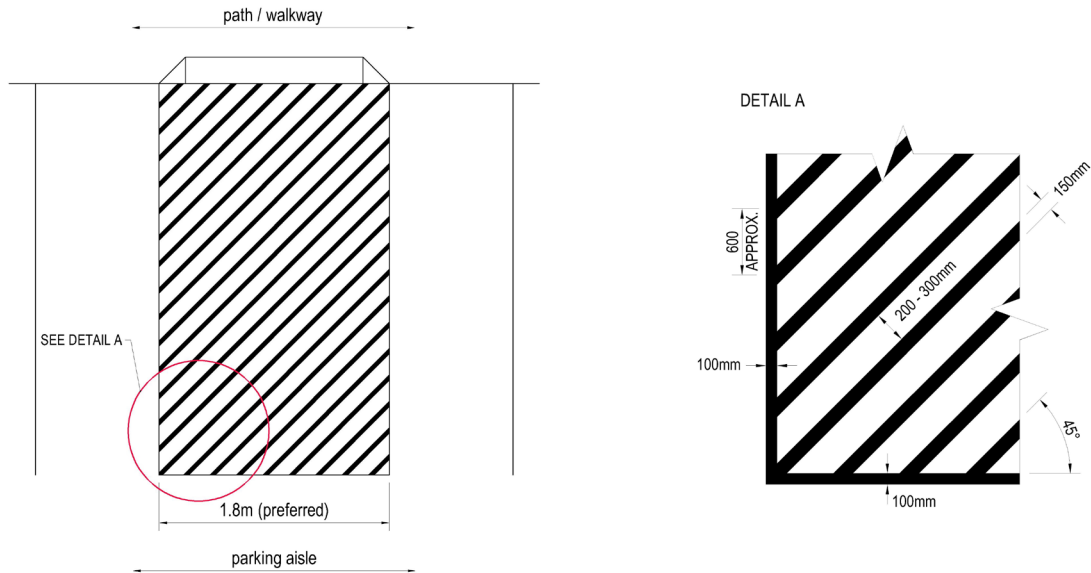

2.1.3 PARKING CONTROL LINES

2.1.3.1 Parking control edge lines

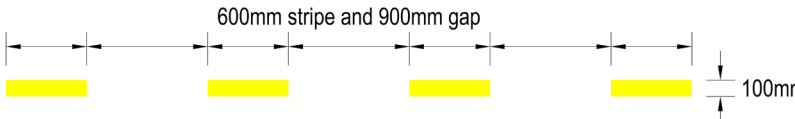
- a) **NS1**; No Stopping at all times 
- b) **NS2**; Restricted parking * - other than Clearway 

* Restricted Parking by time and/or by vehicle type. Signs to be installed to indicate start and end of restriction.

2.1.3.2 Parking space outline

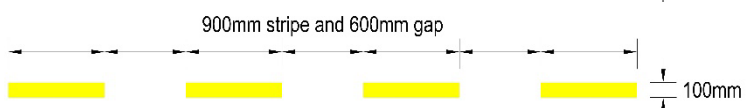
- a) **PS1**; General use 
- b) **PS2**; Special use (vehicle type) * 

* Restricted Parking by time and/or by vehicle type. Signs to be installed to indicate start and end of restriction.

- c) Parking for people with disabilities ** 

** Dedicated parking spaces for people with disabilities shall be outlined on the long edge of an angled parking space and the short edge of a parallel space, except any side delineated by a kerb, barrier, or wall.

PARKING CONTROL LINES (continued)

2.1.3.3 Shared space or area markings

Within off street car parking areas, shared areas or spaces located adjacent to the longitudinal side only of dedicated angle parking spaces, for people with disabilities, shall have a yellow outline and yellow diagonal stripes with a slip resistant surface.

Yellow diagonal stripes shall be marked at an angle of 45 ± 10 degrees to the side of the space.

Yellow diagonal stripes shall not be used in trafficked areas including walkways within or partly within a shared area, parking aisles or roadways.

Walkways within or partly within a shared area or space shall be marked with yellow 100 mm wide unbroken longitudinal lines on both sides of the walkway excepting any side delineated by a kerb, barrier or wall **see 2.1.8.10**.

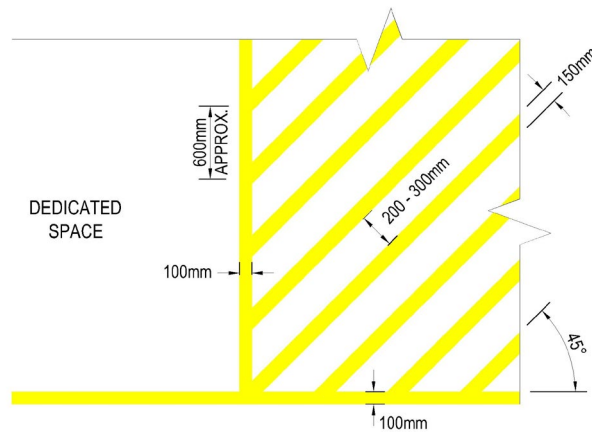

2.1.4 NO PEDESTRIAN ZONE (OFF STREET PARKING AREAS ONLY)

Within off street car parking areas, the area adjacent a boom barrier may be marked with white diagonal stripes on a red patch to discourage pedestrians from entering this area.

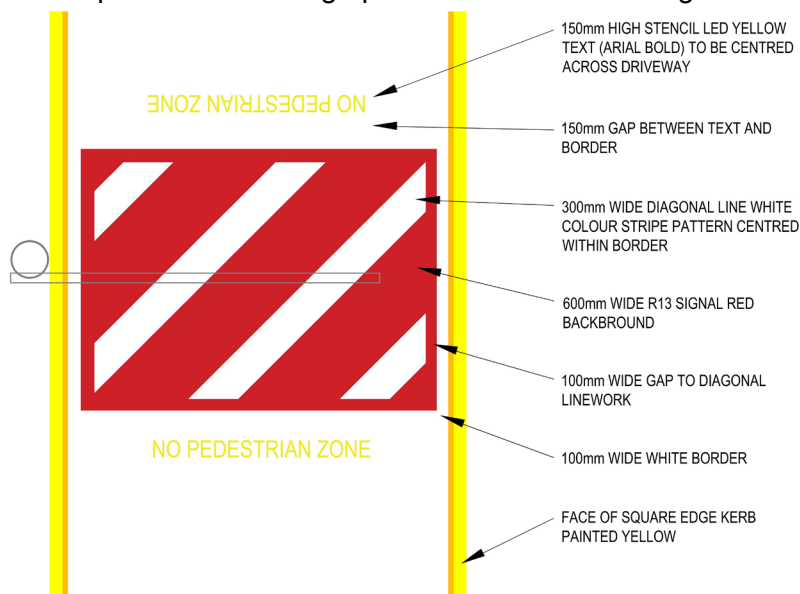

2.1.5 LONGITUDINAL LINES AT RURAL AND URBAN INTERSECTIONS

For more information regarding gaps in barrier lines see 2.1.18, 3.3.2, 3.4.4, 3.4.5.

For more intersection examples see 2.1.15.8 - 2.1.15.9.

2.1.5.1 Various accesses on to main roads

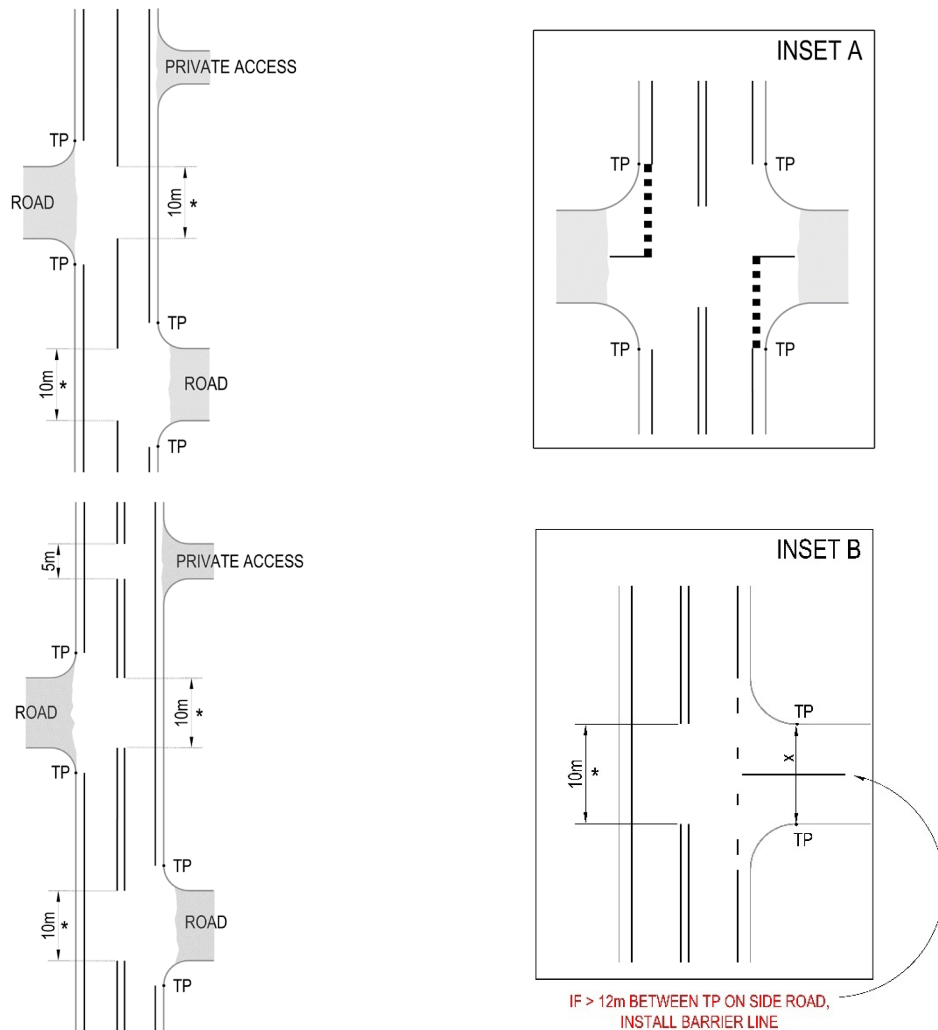

NOTES:

1. The gap in the edge line for side roads starts/ends at the tangent point or clear of the vehicle turning envelope.
 2. Where sufficient width is available on the sealed shoulder or apron, a Give Way line or Stop line (in accordance with AS 1742.2 Clause 5.5.4) may be installed. **See Inset A** for example.
 3. **Where the local road approach is > 12 m wide a single barrier line should be provided. See Inset B for example and see 3.3.17.**
 4. Continuity line may be used across wide side roads, **see 3.3.11.3.**
 5. Edge line type **see 2.1.1.4.**
 6. Warrant for edge lines **see 3.4.7.**
- * ARR 134 allows a driver to cross **single unbroken and** double one-way barrier lines to enter or leave the road. Nevertheless, a gap of 10 m is provided to provide drivers with a visual cue to the location of a side road and where to prop. **See 2.1.18.1 and 2.1.18.2 for gaps in two-way double barrier lines.**

LONGITUDINAL LINES AT INTERSECTIONS (continued)

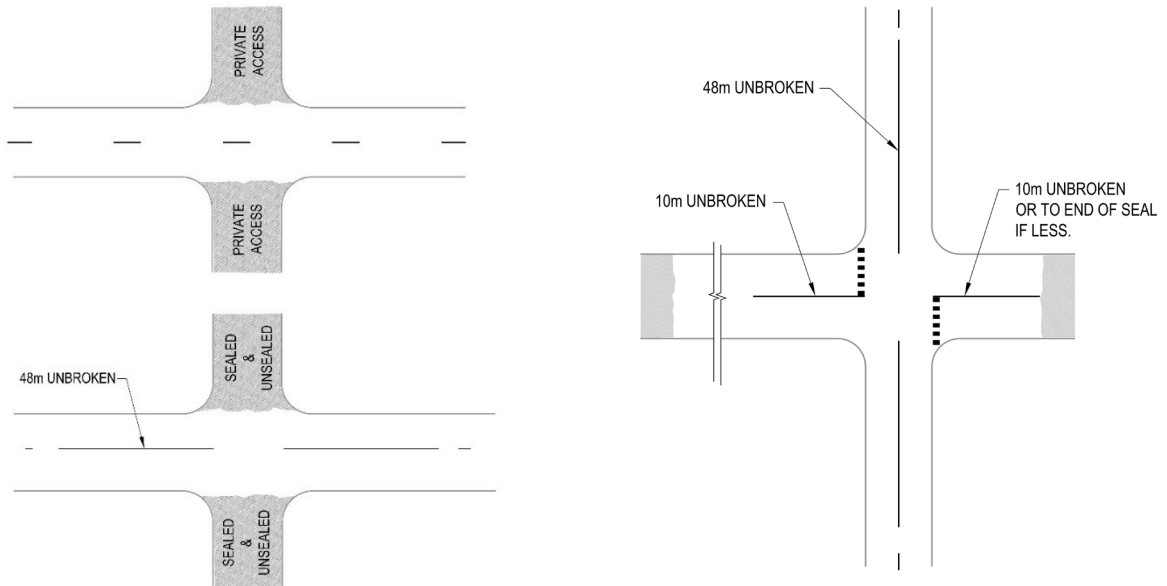
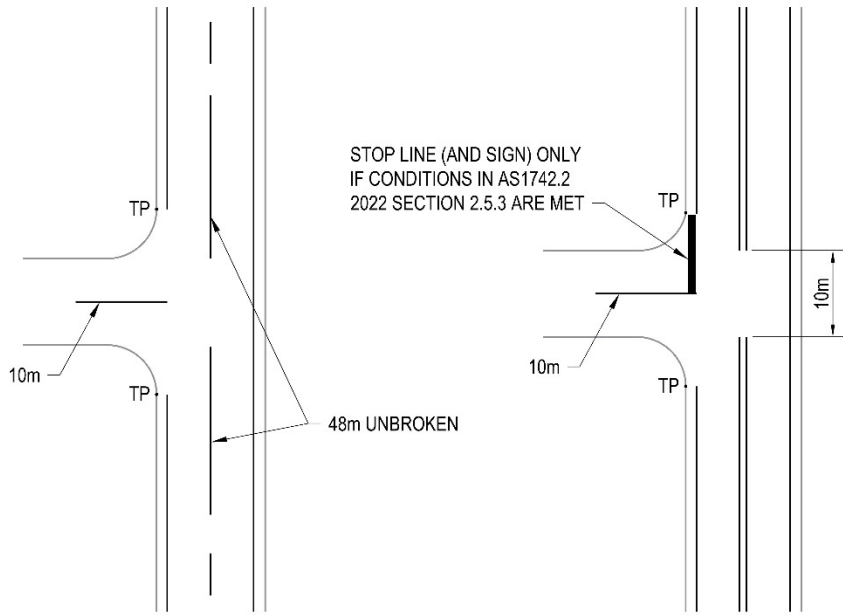

NOTE: The 48 m unbroken line shall only be a single or double barrier line. See 2.1.18 for selection of single or double line in these scenarios.

LONGITUDINAL LINES AT INTERSECTIONS (continued)

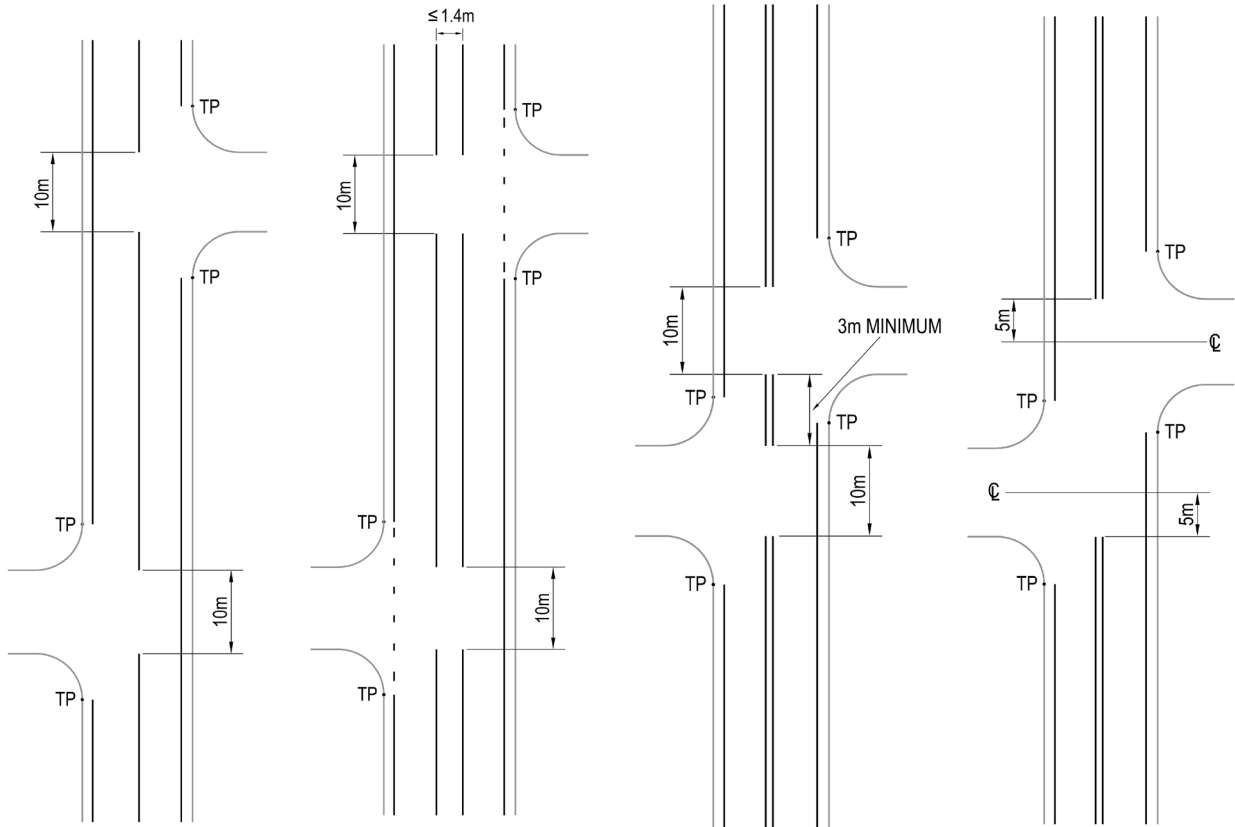

THESE 2 EXAMPLES CAN ALSO BE APPLIED TO WIDE BARRIER LINE TREATMENT

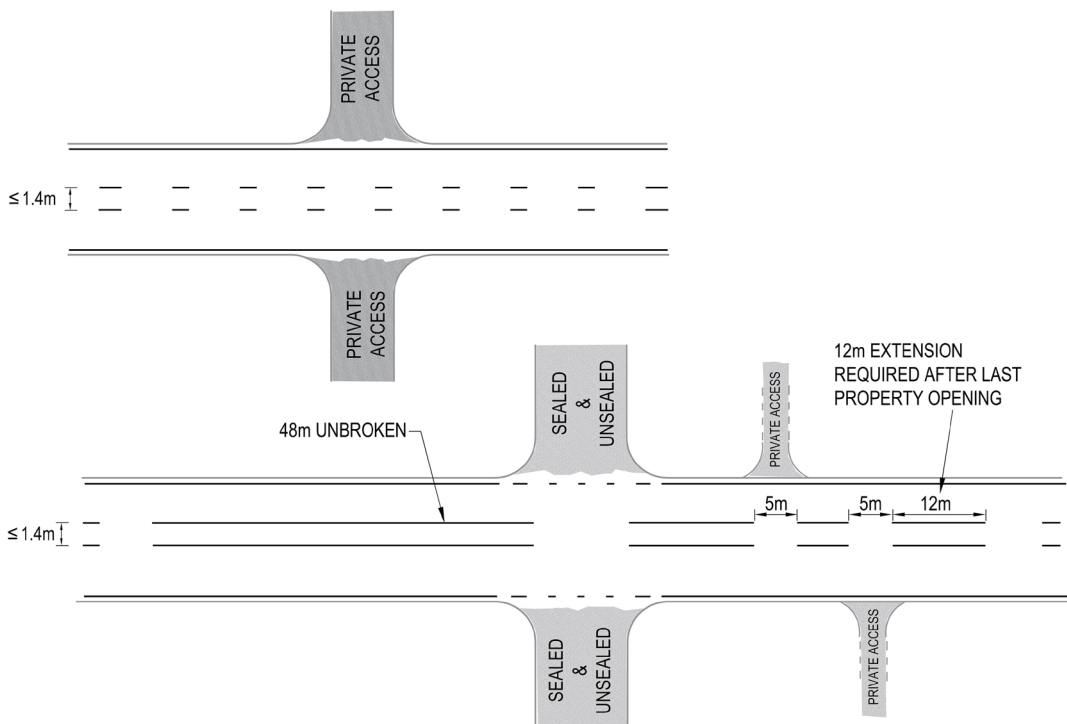

NOTE: 5 m gap at private entrances can be applied to both double two-way barrier line and wide centre line (double two-way) treatments. The barrier line can be longer than 48 m where private accesses are located as long as it finishes with an unbroken line of at least 12 m. **For use of continuity lines across side roads, see 3.3.11.3.**

2.1.6 DIAGONAL STRIPES AND CHEVRON MARKINGS

2.1.6.1 Diagonal stripes edge treatment

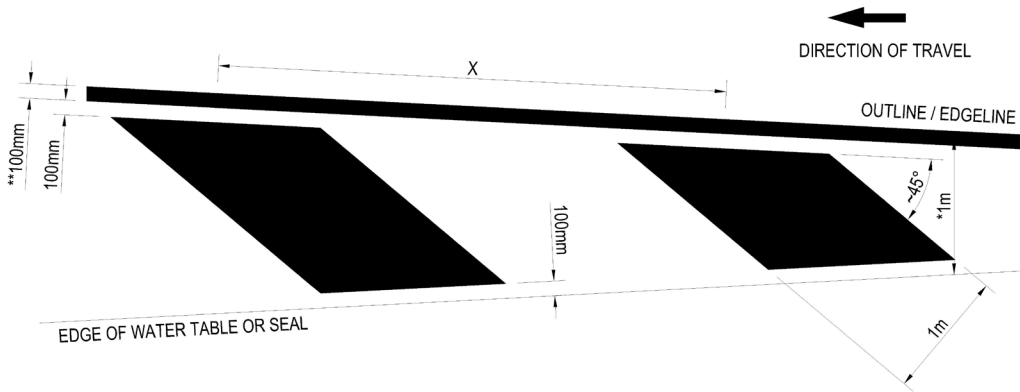

2.1.6.2 Diagonal stripes dividing treatment

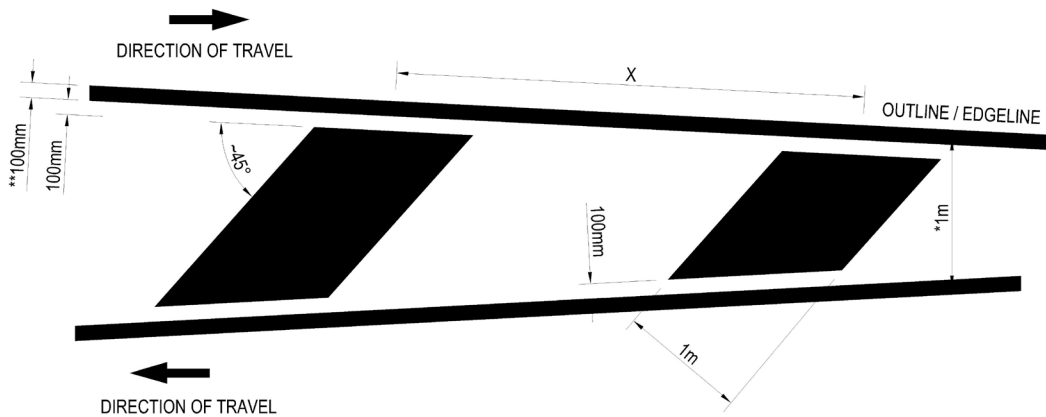

2.1.6.3 Chevron Markings

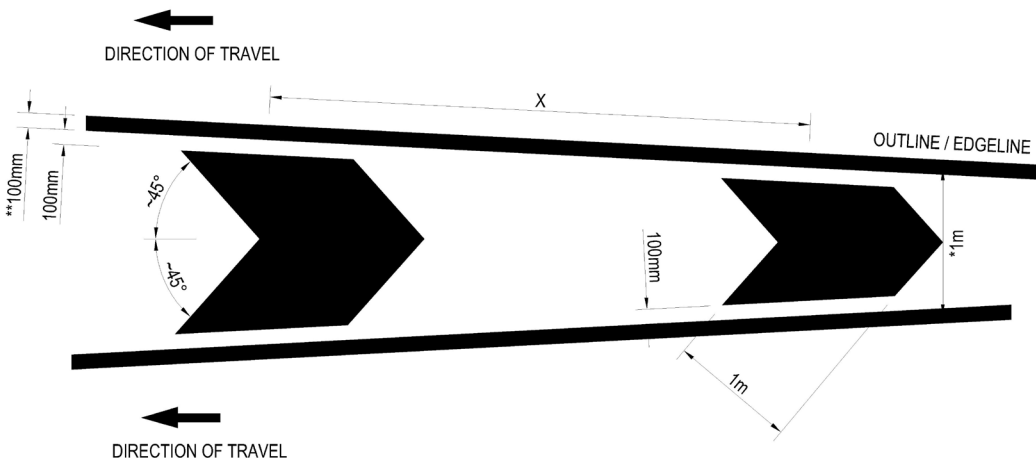

- * 1st diagonal marking or chevron is placed where the width of the treatment is 1.0m.
- ** In rare cases wider outlines/edge lines may be specified on traffic control drawings.
- ~ 45° = nominally 45 degrees
- x Spacing may be modified to suit corner islands, painted islands, and merges.
For design details see **3.3.3**.

2.1.7 ARROWS

Reference: AS 1742.2 Figure 5.34

2.1.7.1 Arrows - common types

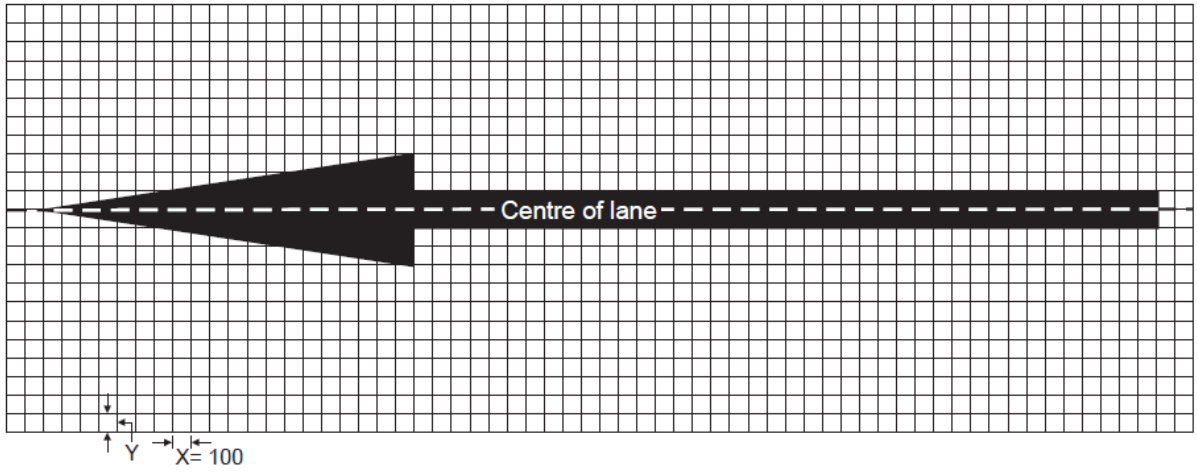

AR1; 6 m long arrow

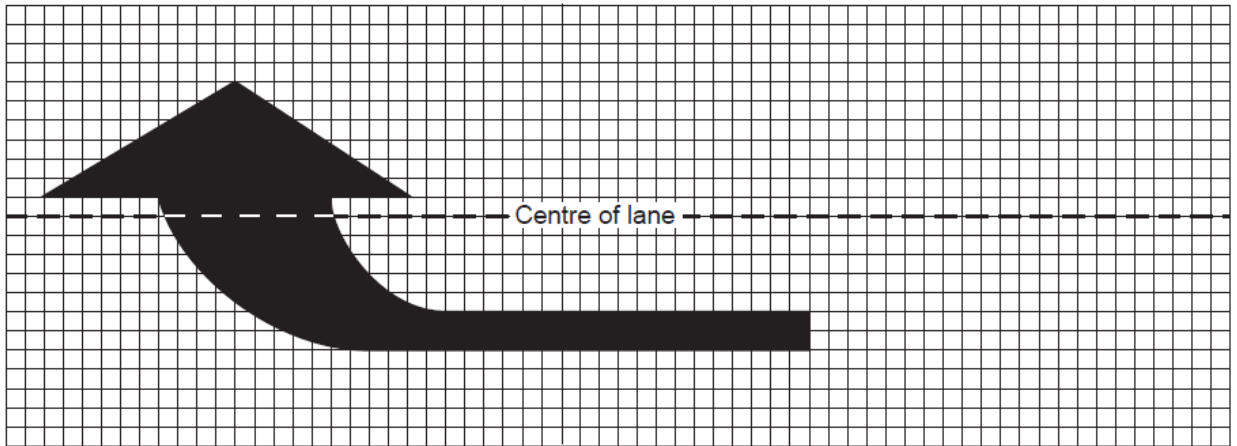

AR3; 4 m long arrow. Reverse for left turn arrow.

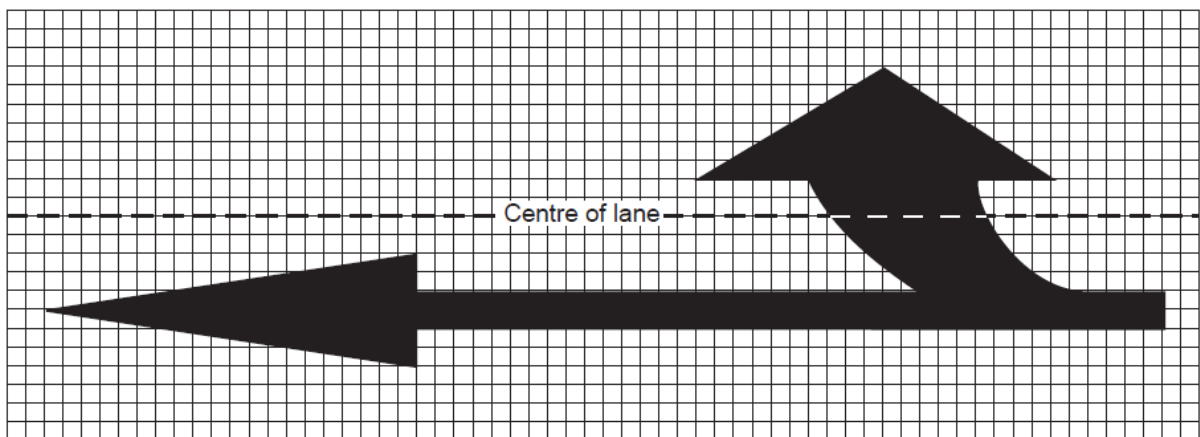

AR4; 6 m long arrow. Reverse for through and left turn arrow.

ARROWS (continued)

2.1.7.2 Arrows - special types

- a) **AR2**; Double turn arrow
(3.4 m long)

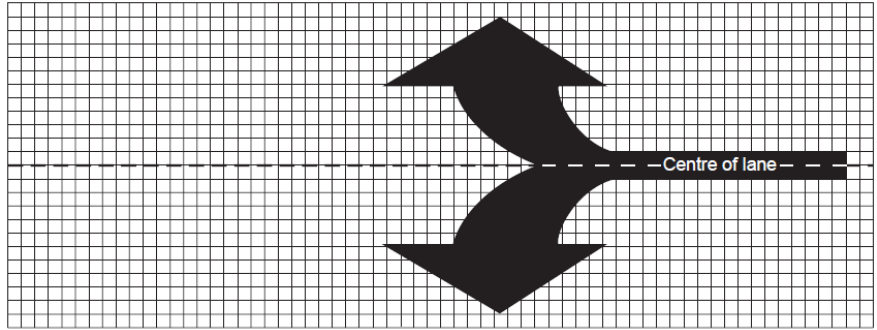

- b) **AR7**; U- turn arrow
(4.4 m long)

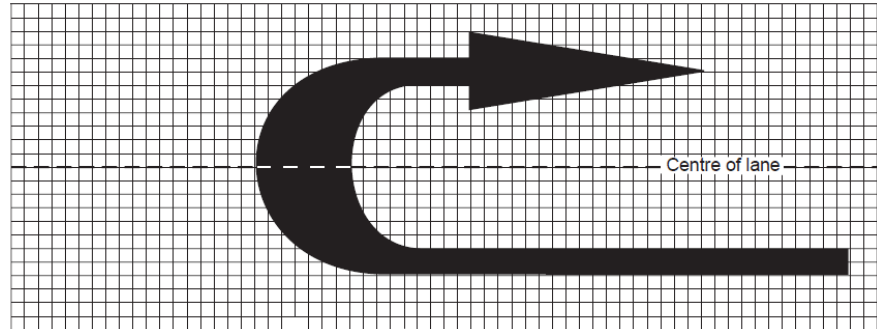

- c) **AR9**; 45° turn arrow
(5.1 m long)

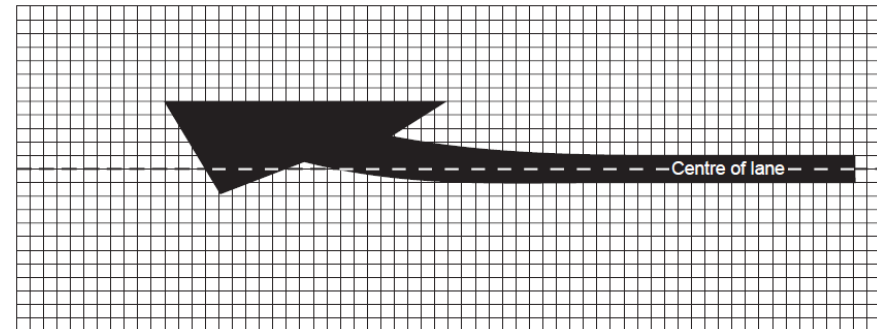

- d) **AR6**; Through, right, left turn arrow
(6 m long)

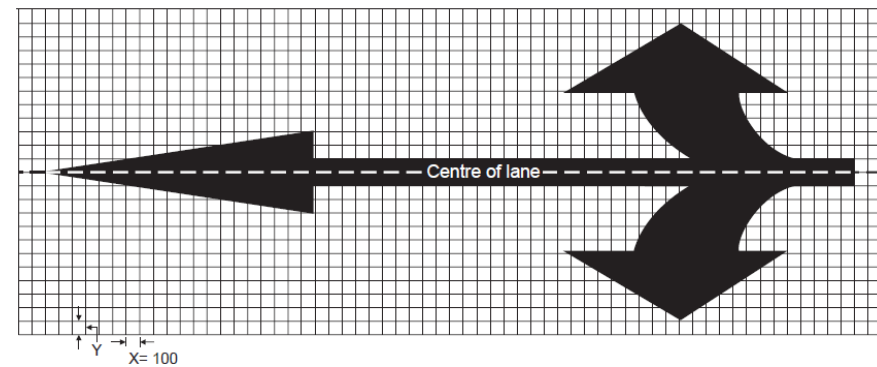

- e) Right, U turn arrow
(8 m long)

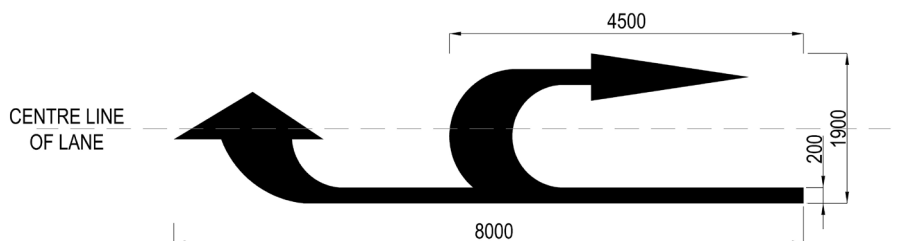

ARROWS (continued)

2.1.7.3 Arrows - lane change

NOTE: For general treatment at lane reductions (merges) refer to AS 1742.2 Clauses 4.6.2 and 5.7.3 for application of arrows. Lane change arrows shall be reflectorized.

AR5-2;
>80 km/h

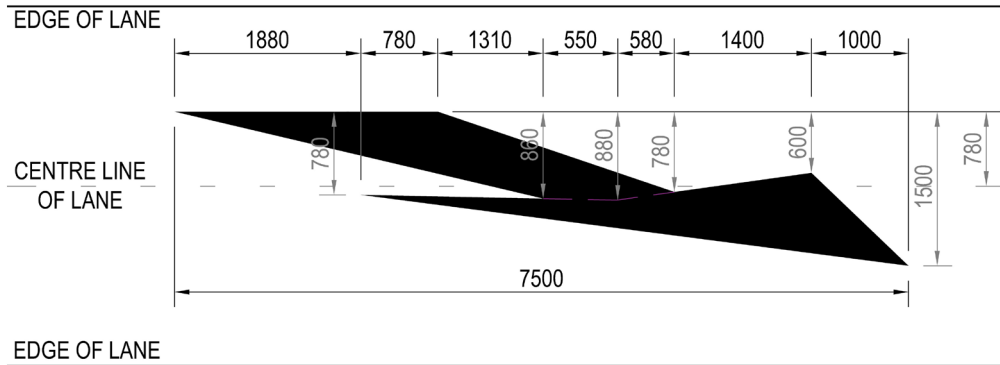

2.1.7.4 Arrows – expressway exit

AR10;

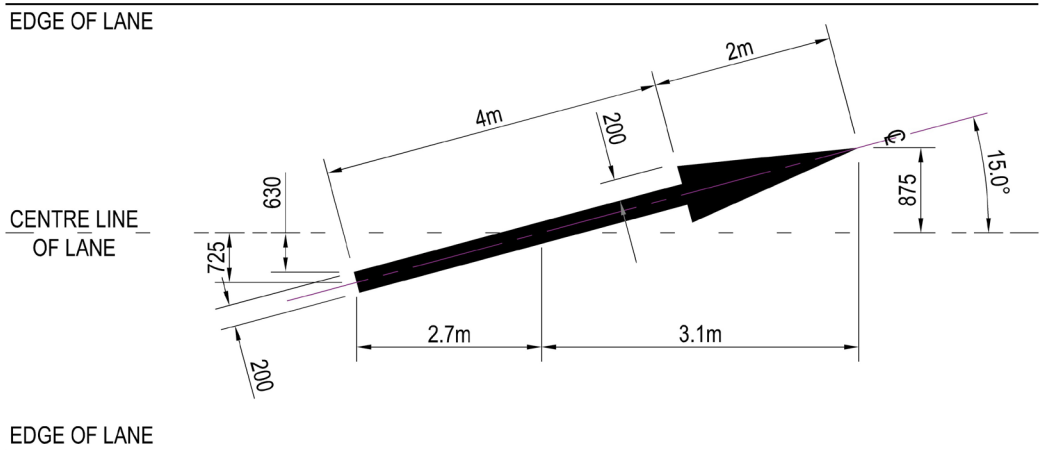

AR11;

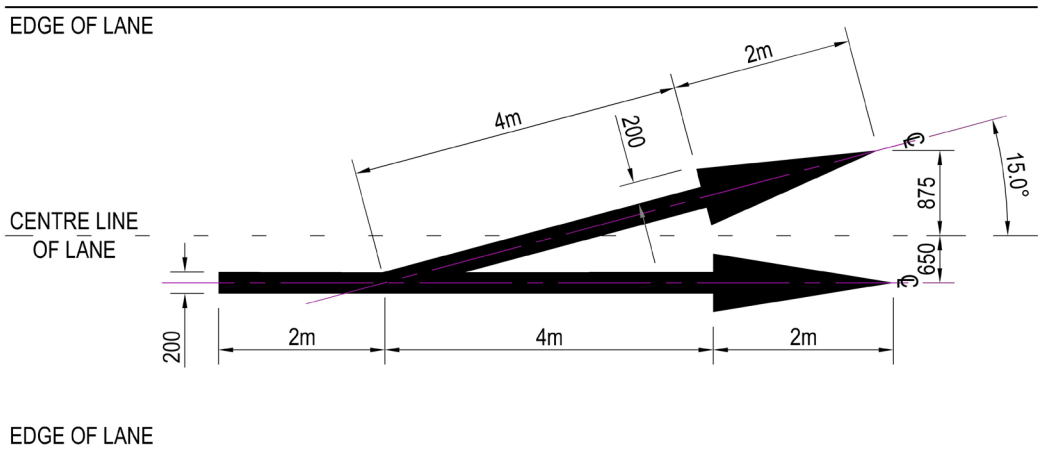

All dimensions are in millimetres unless otherwise indicated.

2.1.8 MESSAGES AND SYMBOLS

2.1.8.1 Letters and Numerals

Letters and numerals other than those shown in Words **2.1.8.2** are available from AS 1742.2. The **height** of letters and numerals shall be 2.5m where the speed limit is up to 80 km/h and 5.0m at higher speed limits unless otherwise specified.

2.1.8.2 Words

See 3.3.16 for the placement of KEEP CLEAR messages and **see 2.1.9** for the placement of RAIL X messages. Refer to *DIT Supplement to AS 1742.10* for use of PED XING and SCHOOL XING messages. Refer *DIT Speed Limit Guidelines for South Australia* for SCHOOL message.

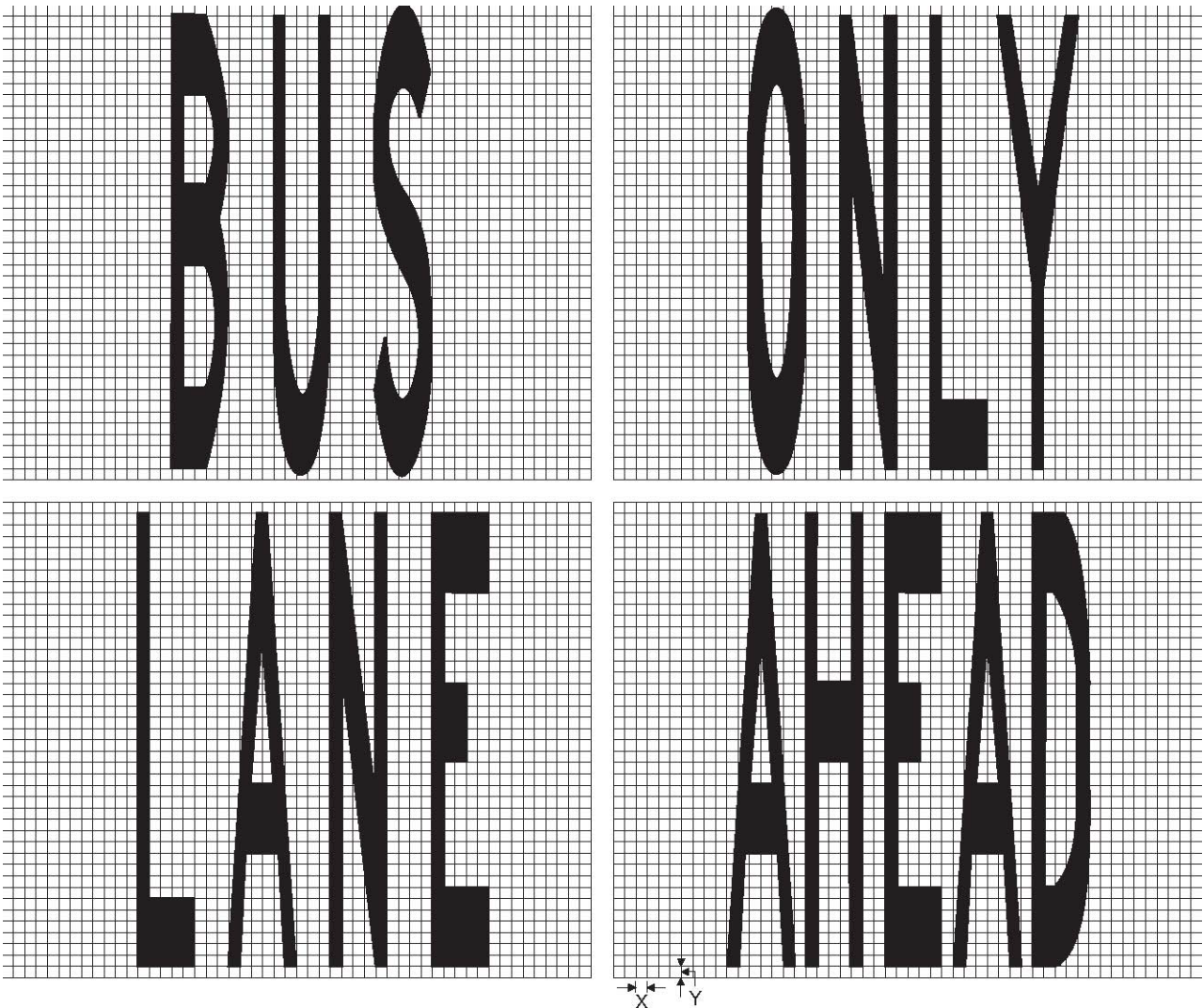

NOTE: The grid width (X) is constant at 100 mm, but the grid height (Y) may vary as follows:

$$Y = \frac{\text{Height of letter or numeral required (mm)}}{40}$$

However, the word AHEAD may be made narrower (e.g., grid width reduced to 75mm) to fit into a lane..

MESSAGES AND SYMBOLS (continued)

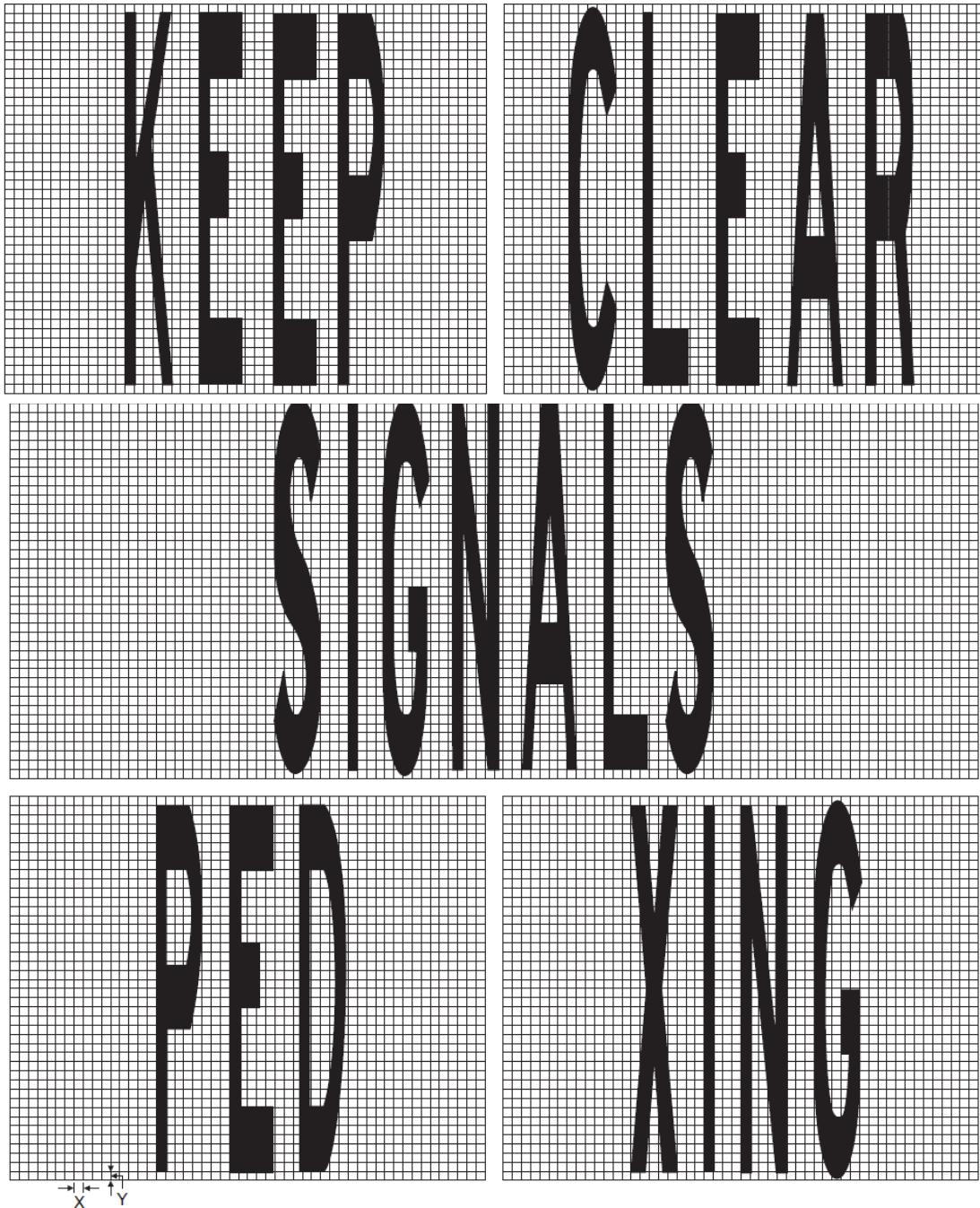

NOTE: The grid width (X) is constant at 100 mm, but the grid height (Y) may vary as follows:

Y = Height of letter or numeral required (mm)

40

MESSAGES AND SYMBOLS (continued)

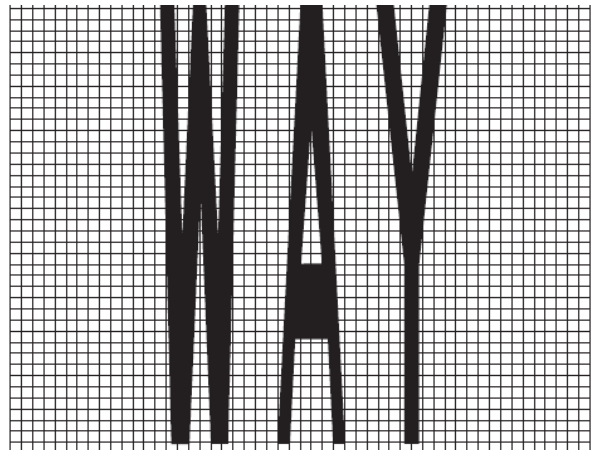
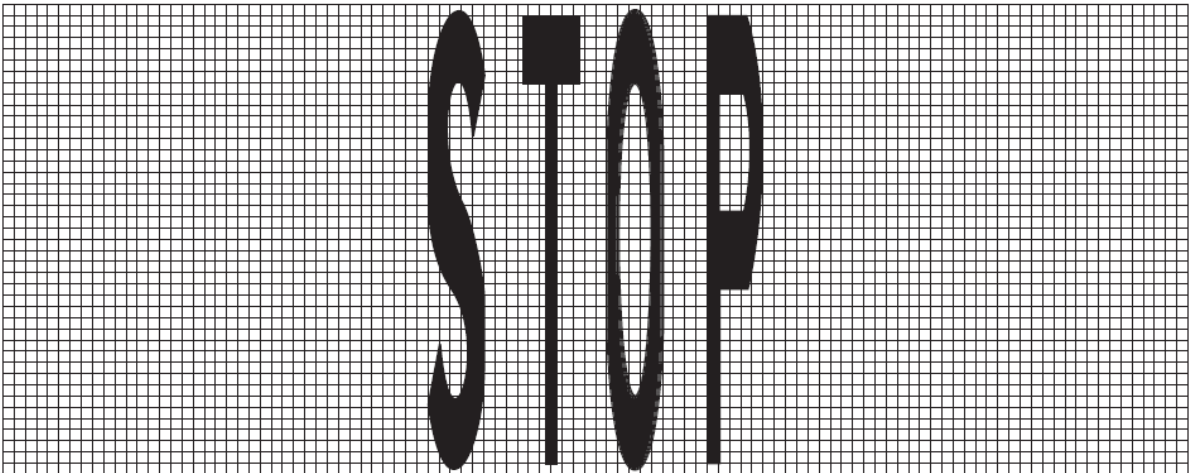
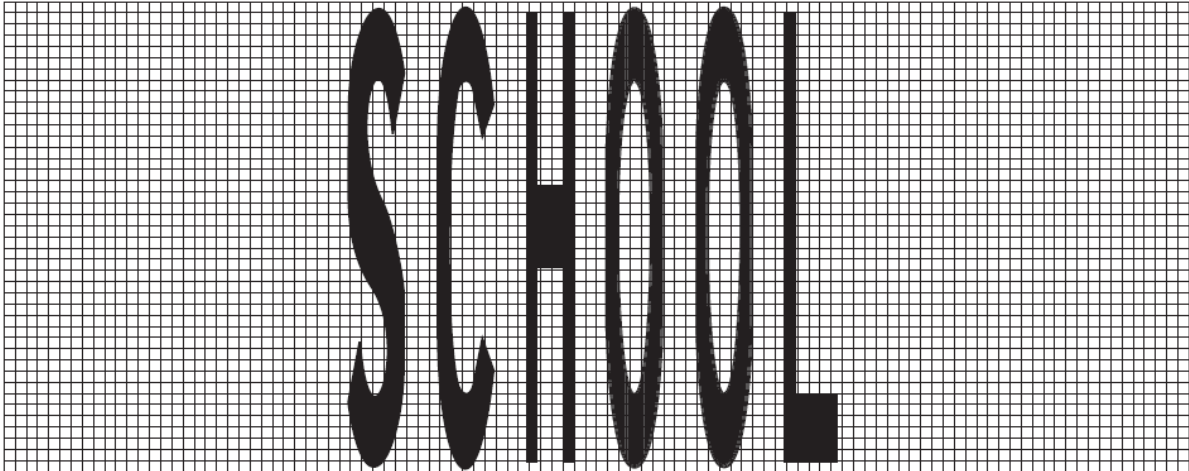

NOTE: The grid width (X) is constant at 100 mm, but the grid height (Y) may vary as follows:

Y = Height of letter or numeral required (mm)

40

MESSAGES AND SYMBOLS (continued)

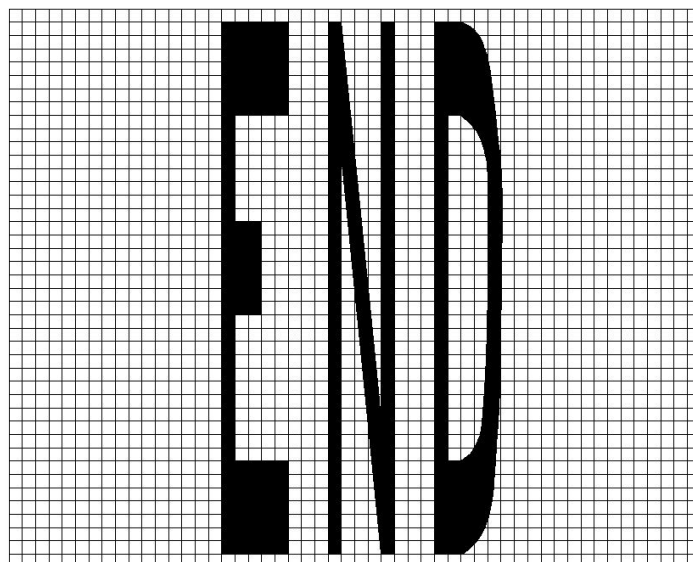
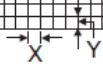
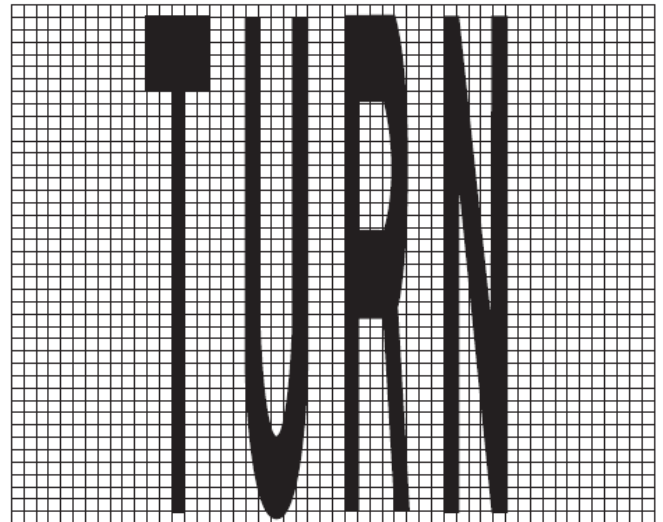
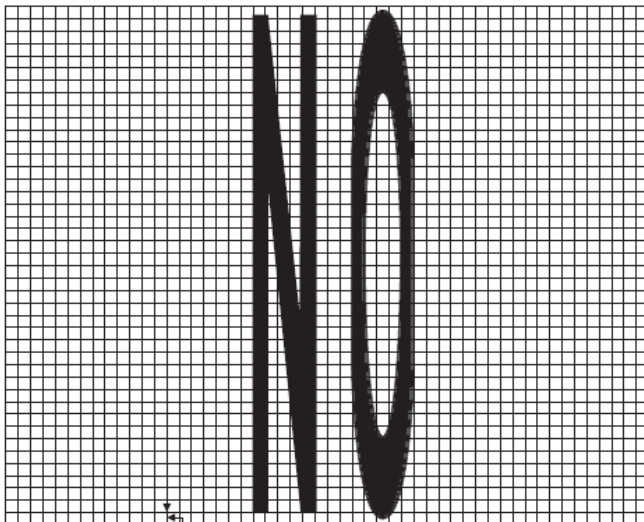
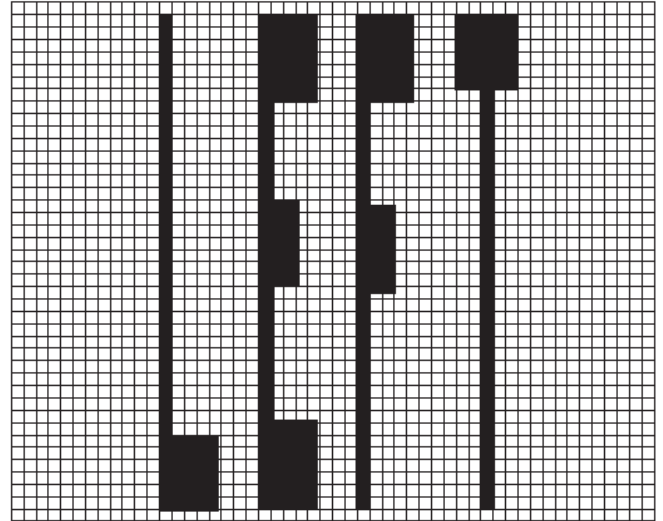

NOTE: The grid width (X) is constant at 100 mm, but the grid height (Y) may vary as follows:

Y = Height of letter or numeral required (mm)

40

MESSAGES AND SYMBOLS (continued)

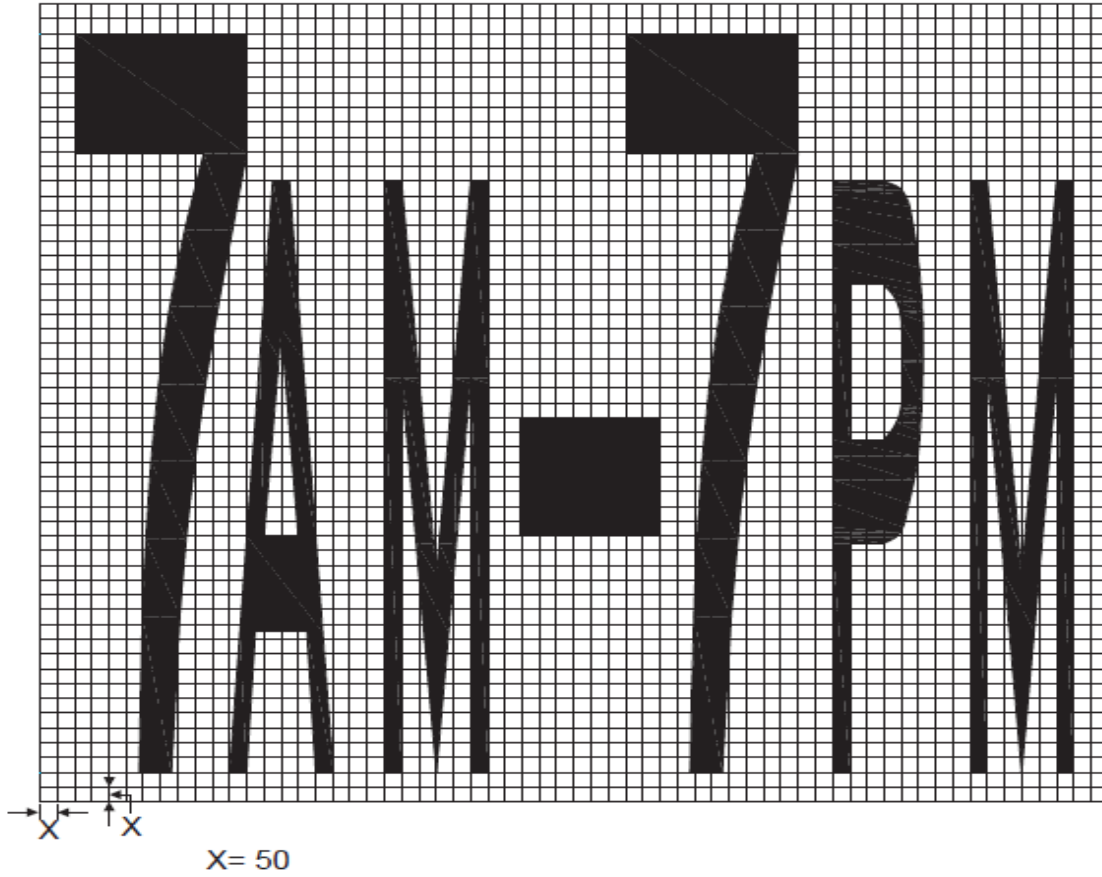

2.1.8.3 Path pavement symbols

Pedestrian

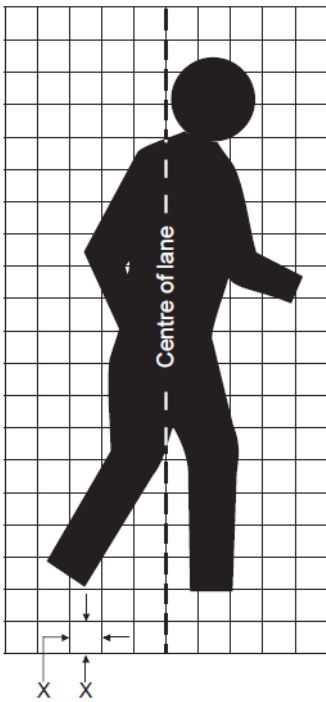

X=75mm

Arrow

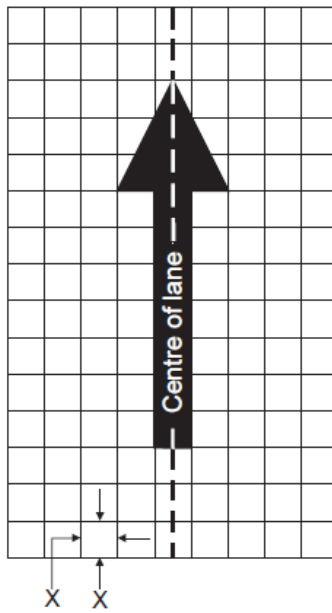

X=100mm

Bicycle

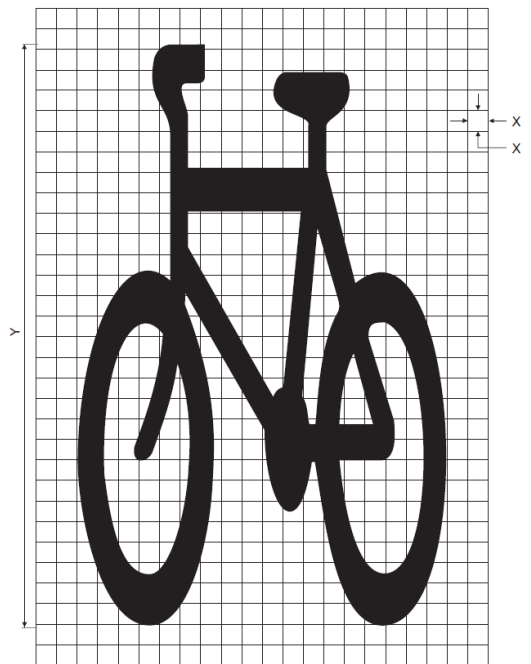

X=28mm Y=800mm

MESSAGES AND SYMBOLS (continued)

No-Bicycles (for path use only)

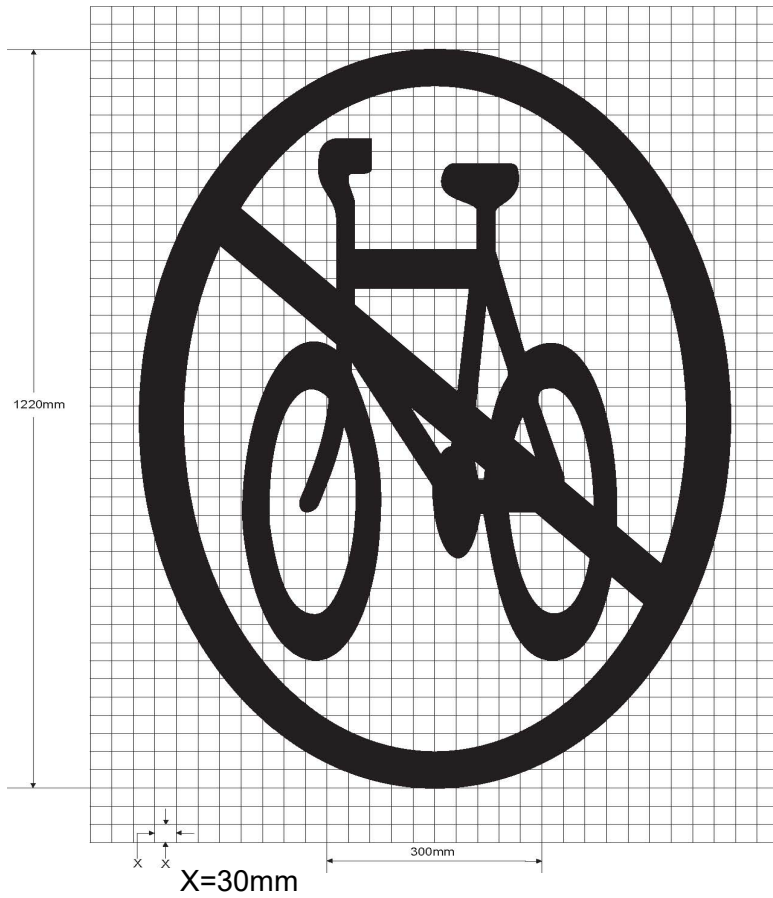

All skaters prohibited

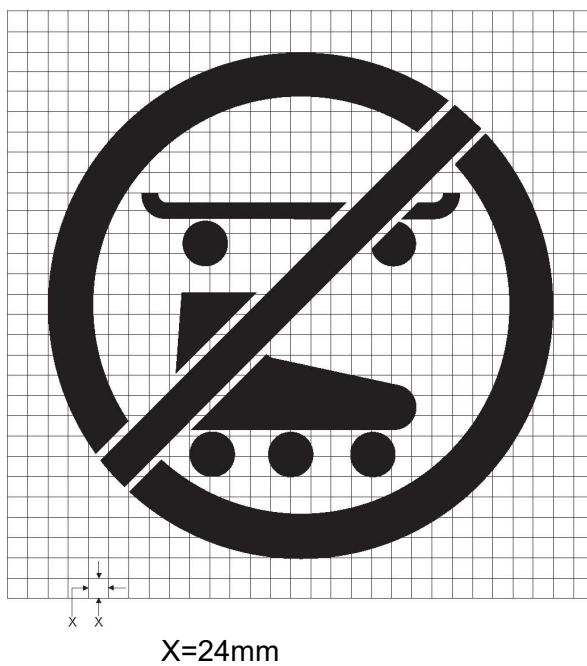

MESSAGES AND SYMBOLS (continued)

2.1.8.4 Bicycle

2.1.8.4.1 Bicycle pavement symbol for Road

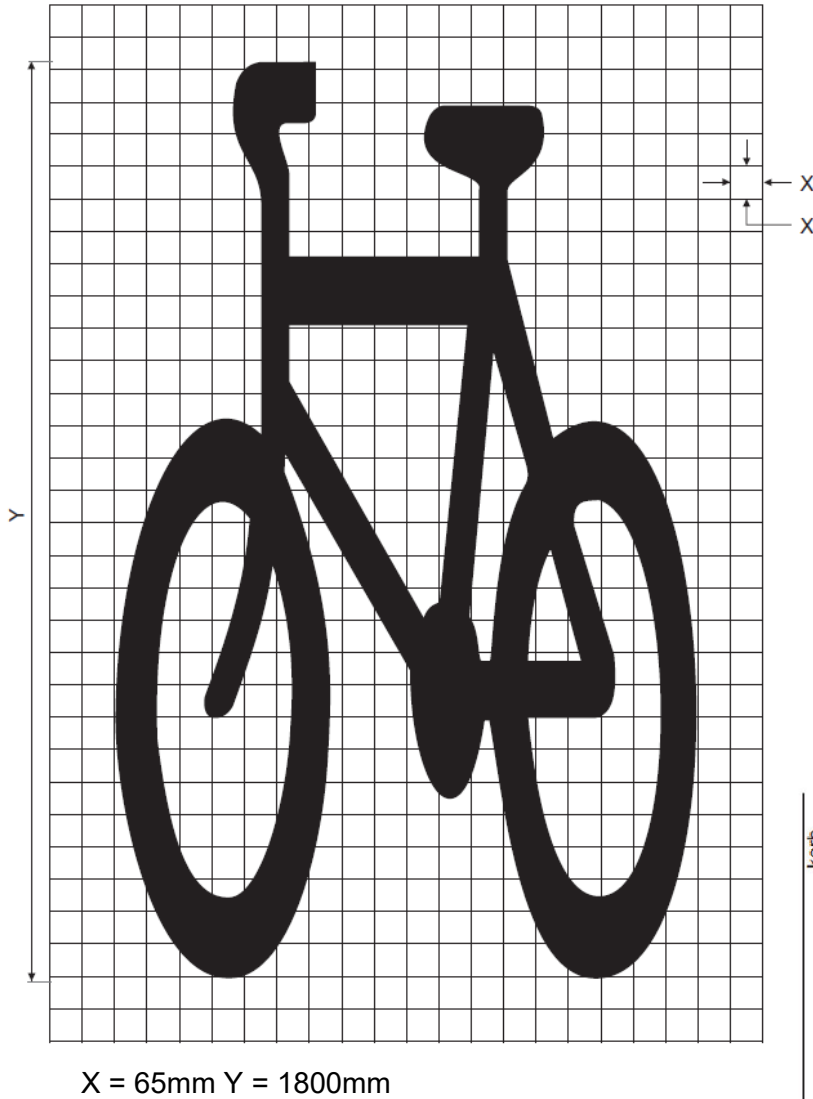

For bicycle lanes less than 1.2m, bicycle pavement symbol may be reduced proportionally. As an alternative, parts of the bicycle pavement symbol may be omitted to ensure the symbol fits within the lane (refer to diagram).

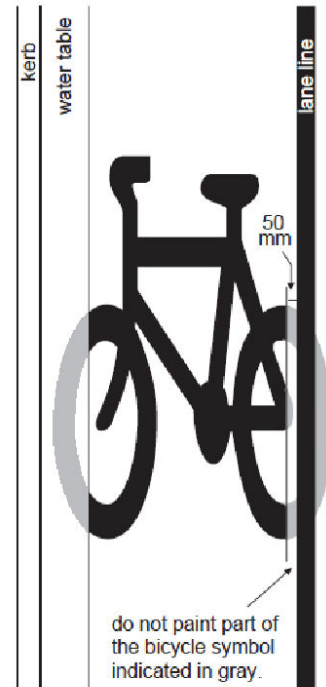

MESSAGES AND SYMBOLS (continued)

2.1.8.4.2 Painted Bicycle Lane wording for Road

Reference: AS 1742.9 Clause 2.3; OI 9.2

Bicycle pavement symbol with the word lane underneath may be used when the bicycle lane is located away from the kerb such that signs are inappropriate. Refer to OI 9.2 for more detail.

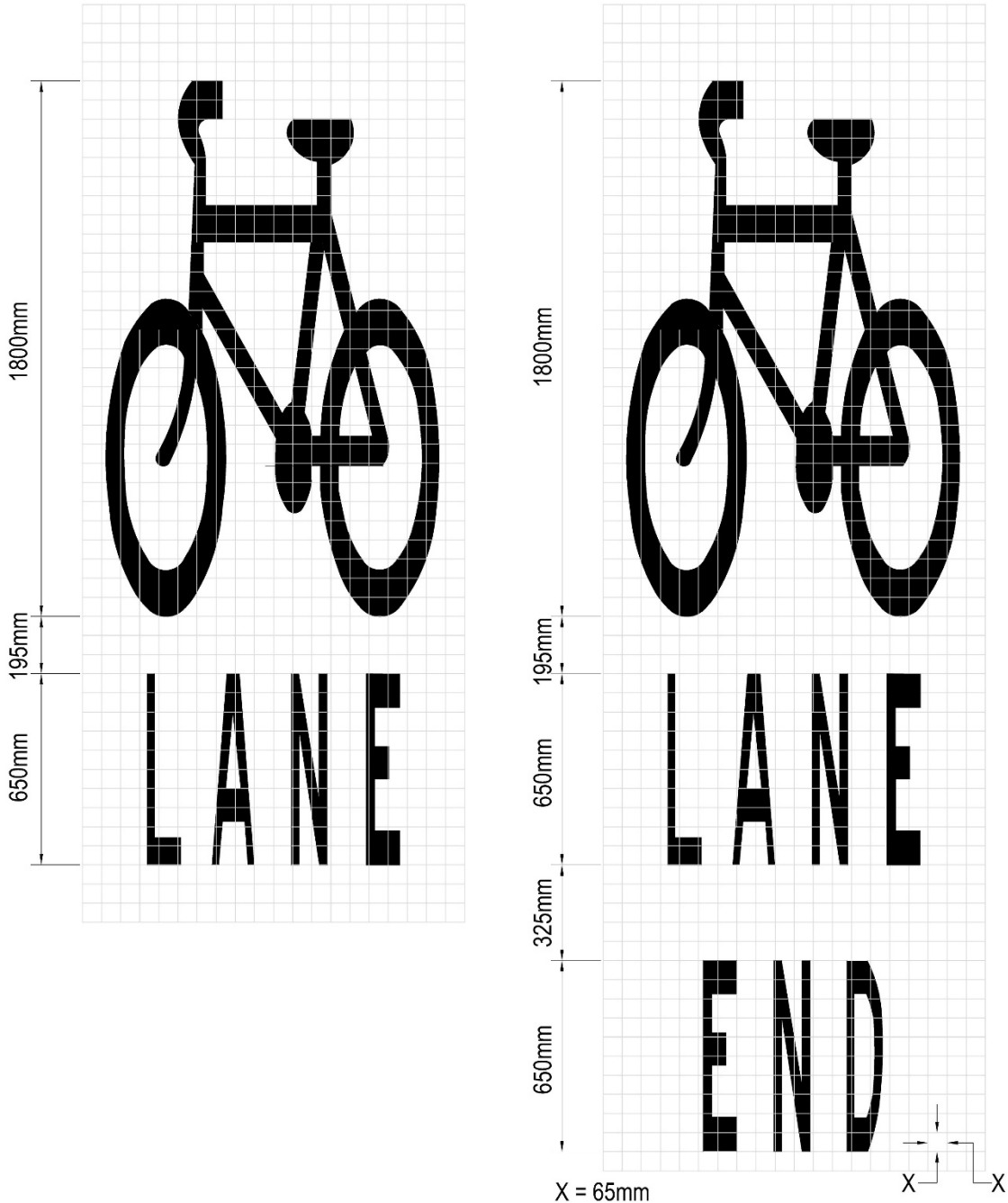

MESSAGES AND SYMBOLS (continued)

2.1.8.5 Sharrows

Reference: OI 9.4

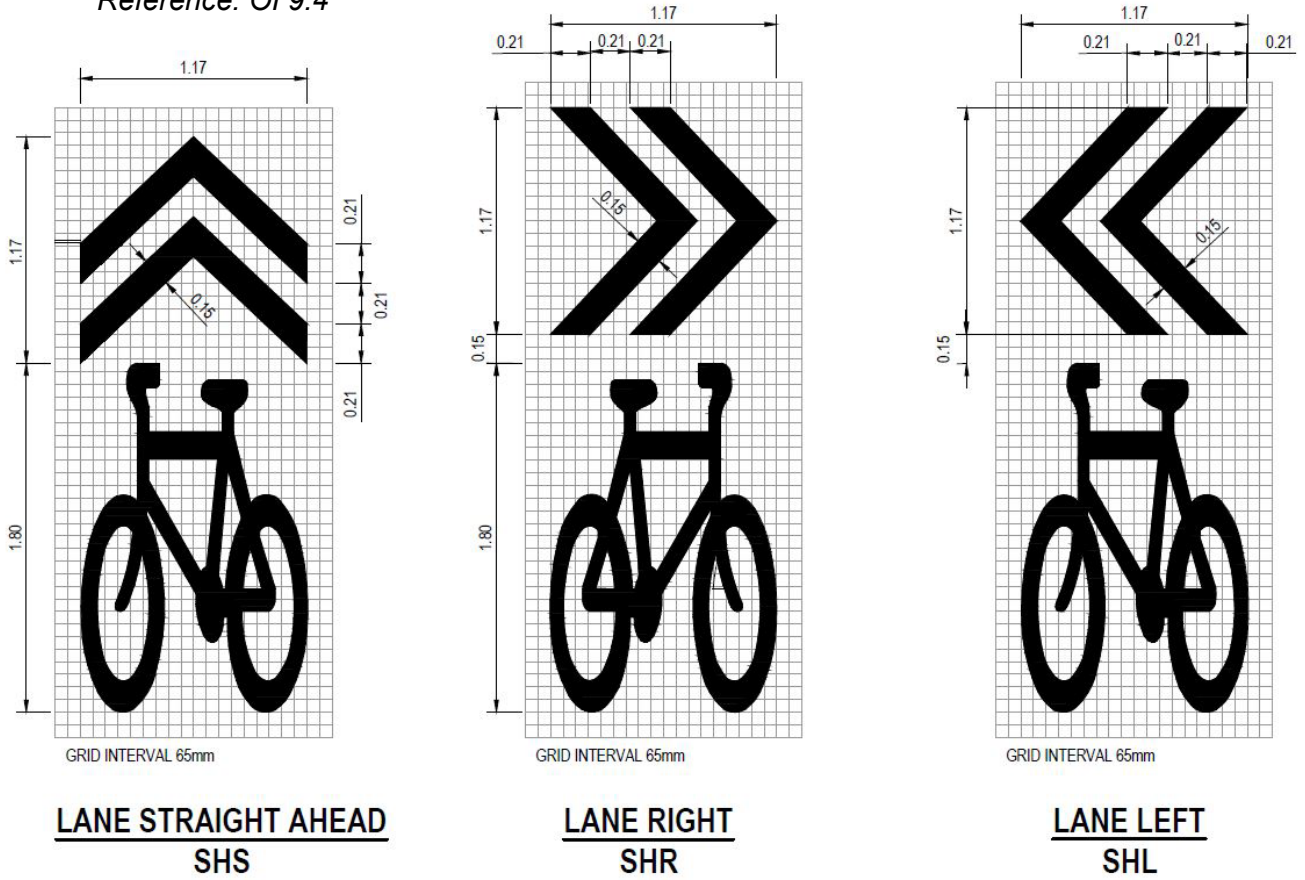

2.1.8.6 Hook Turn Storage Area

Reference: AS 1742.9 Clause 2.3; GRD Part 4A 10.6.1

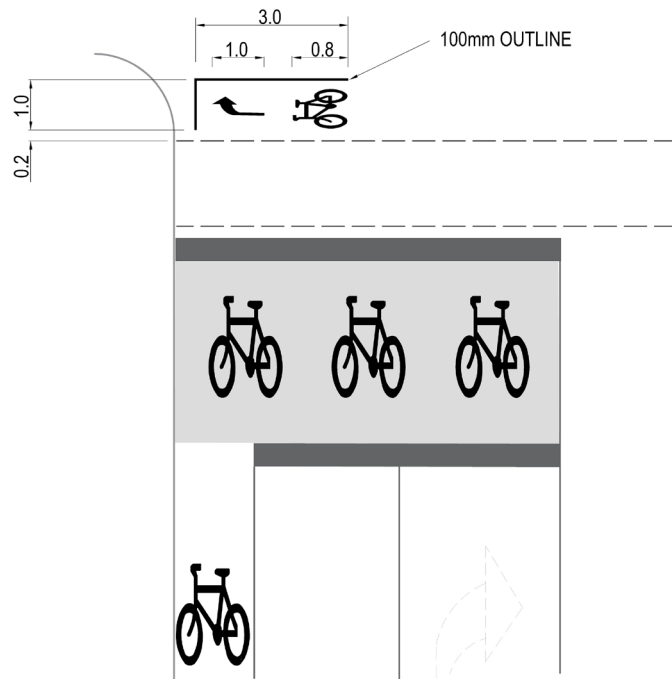

MESSAGES AND SYMBOLS (continued)

2.1.8.7 Identification of dedicated parking space for electric vehicle charging

Reference: The Code Section 9.7; ARR Rule 203C and Road Traffic (Road Rules – Ancillary and Miscellaneous Provisions) Regulations 2014 regulation 19A

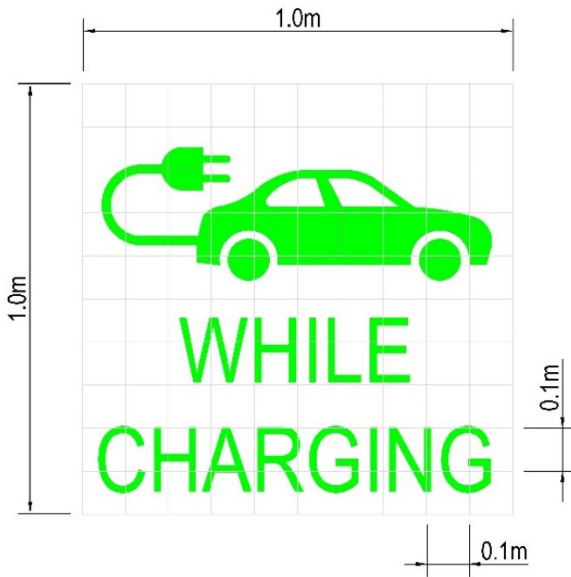

Where a dedicated parking space for electric vehicle charging (Rule 203C) is identified by a pavement marking, it shall be identified by the electric vehicle charging symbol, including the words 'while charging', painted in green on a white 1m square background. For spaces where Rule 203B applies, the words 'while charging' shall be omitted.

The symbol shall be centrally located within the parking space.

2.1.8.8 International symbol of access

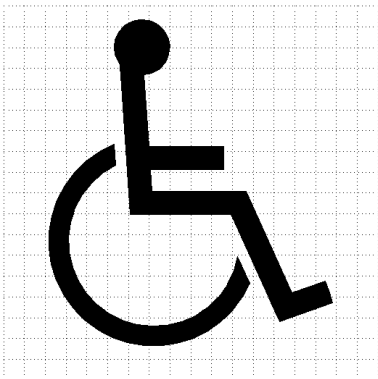

(grid shown for positional purposes only)

Accessible boarding indicator patch (station platforms only)

Symbol shall be centrally located within the blue background and is for left and right directions.

The colour used for the blue background shall be "Ultramarine" (AS 2700-B21).

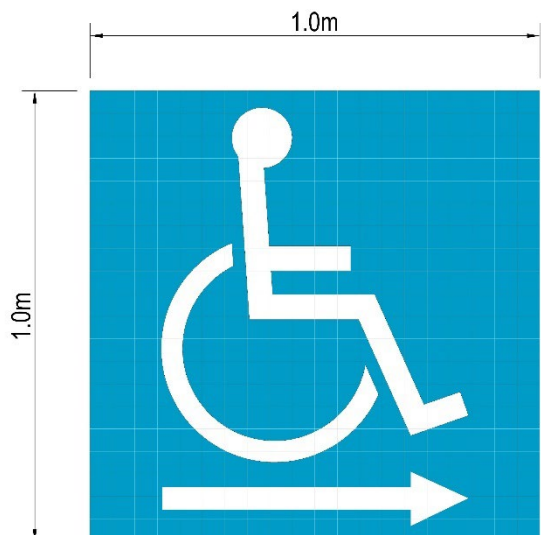

MESSAGES AND SYMBOLS (continued)

Identification of dedicated parking space for people with disabilities

Symbol shall be centrally located within the blue background.

The colour used for the blue background shall be “Ultramarine” (AS 2700-B21)



2.1.8.9 Station platforms

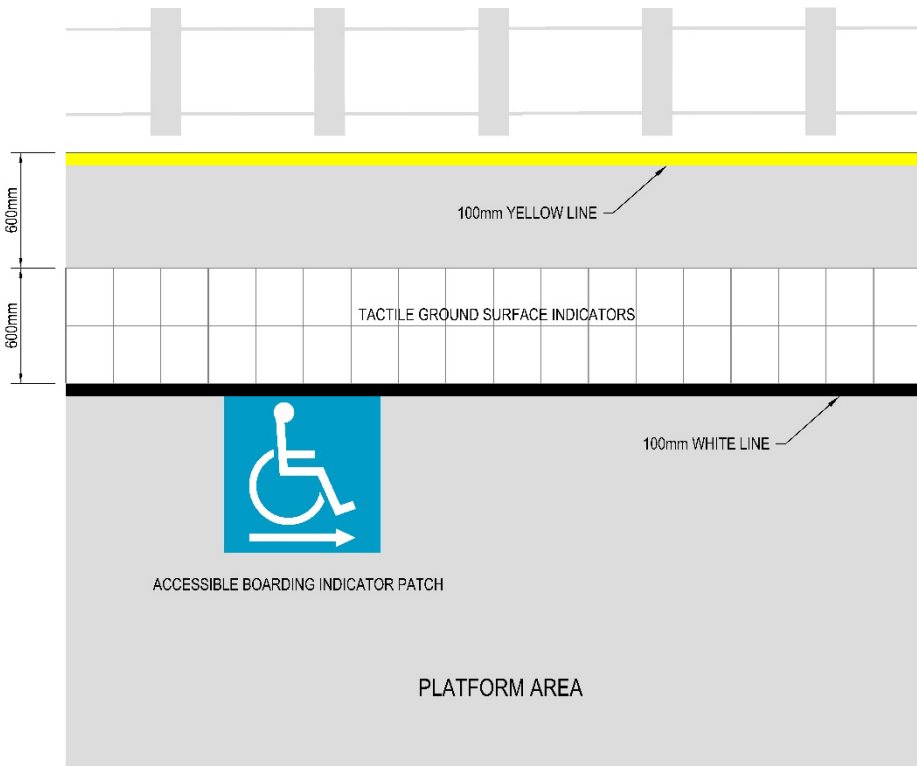

NOTE: For design requirements specific to station platforms, contact DIT’s Technical Services.

MESSAGES AND SYMBOLS (continued)

2.1.8.10 Dedicated parking space identification & delineation (angle parking)

Each dedicated parking space for people with disabilities shall be identified by a white symbol of access on a blue background in the centre of the space between 500mm and 600mm from its entry point.

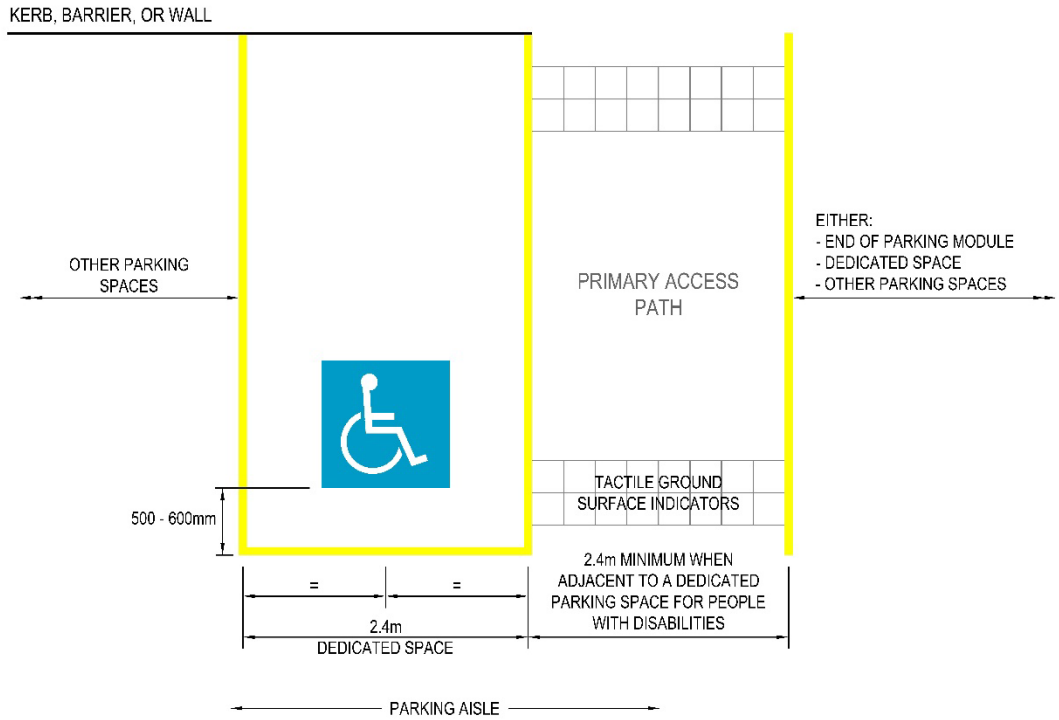

NOTE: The primary access path or the shared space can be located on the left or right side of the dedicated space.

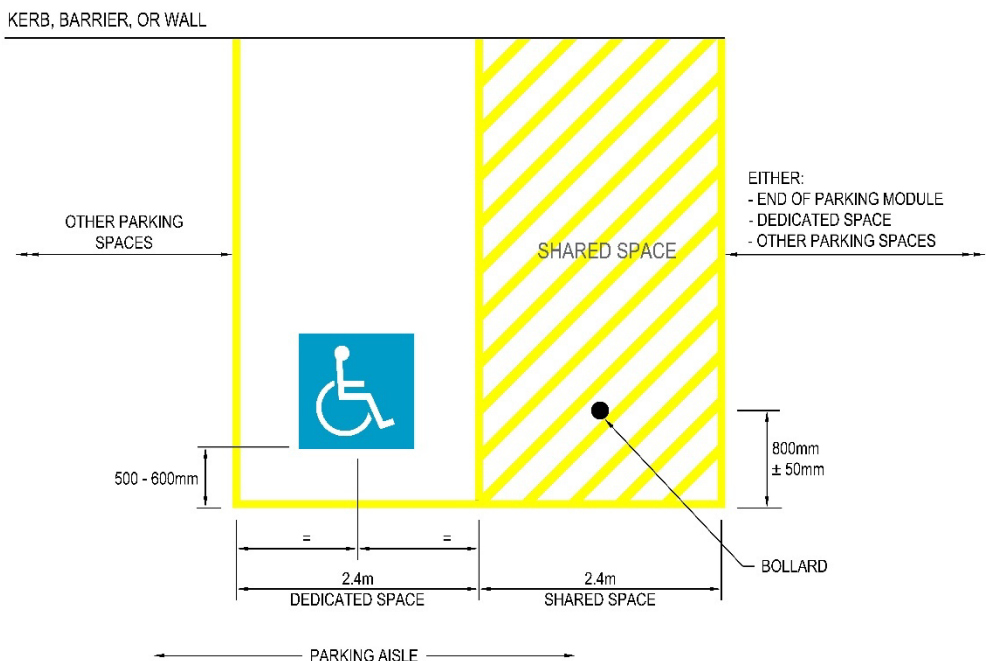

2.1.9 RAILWAY LEVEL CROSSING PAVEMENT MESSAGE

Reference: AS 1742.2 Clause 5.8 and Figure 5.39

Urban $\leq 70\text{km/h}$

(The message shall commence with the 'X')

Rural $\geq 80\text{km/h}$

(The message shall commence with the 'RAIL')

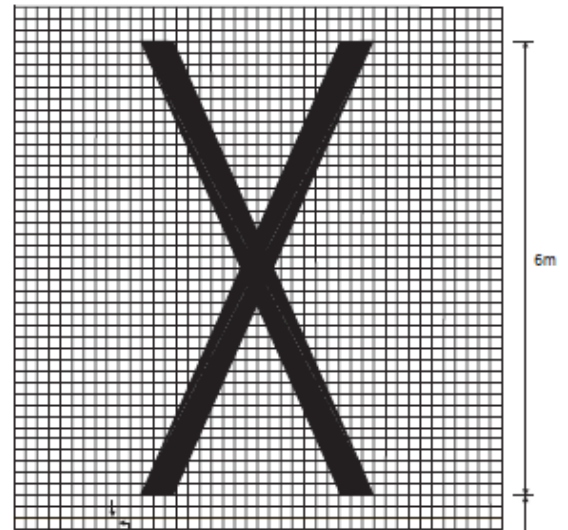
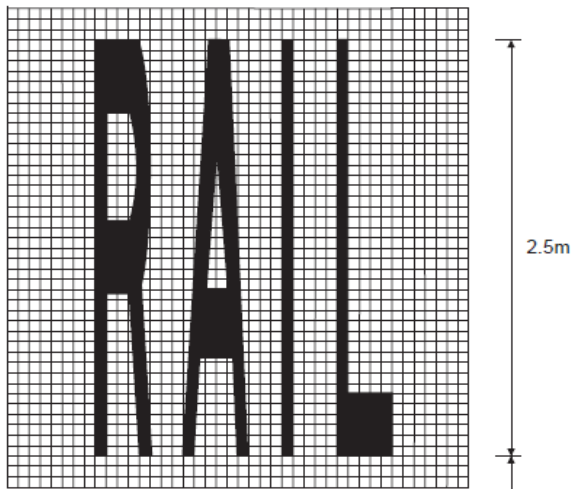

2.5m

7.5m

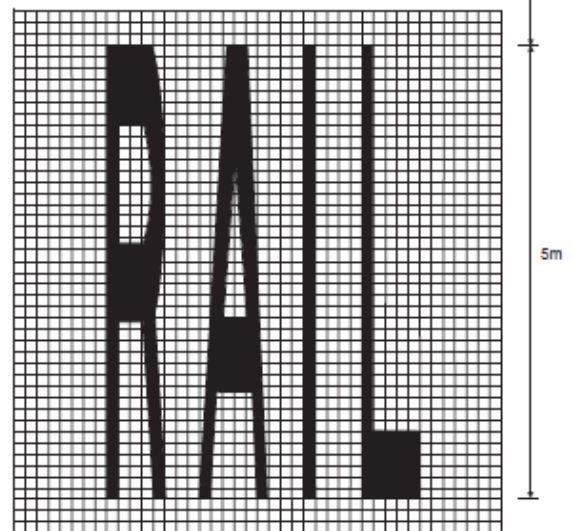
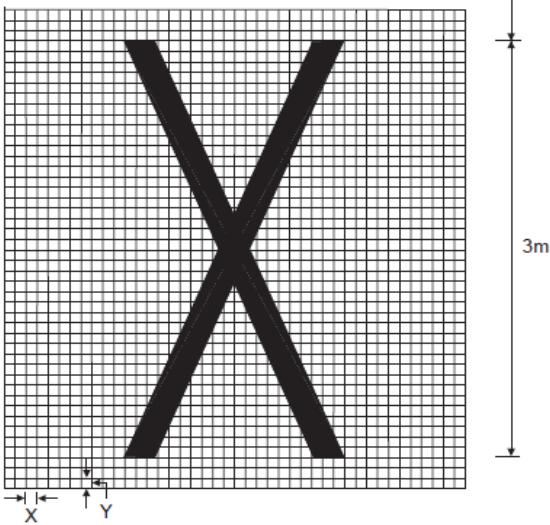

3m

5m

NOTES:

1. Message is from bottom up.
2. The grid width (X) is constant at 100 mm, but the grid height (Y) may vary as follows:
 $Y = \frac{\text{Height of letter or numeral required (mm)}}{40}$
3. Marking to commence 15m to 20m beyond the first warning sign back from the railway level crossing. Refer to AS 1742.7 Figures 4.4 - 4.6
4. When a new message scheme is required, the above example shall be used. When repainting original message, existing markings can be used.

2.1.10 RAILWAY LEVEL CROSSINGS YELLOW BOX (cross-hatched) MARKINGS

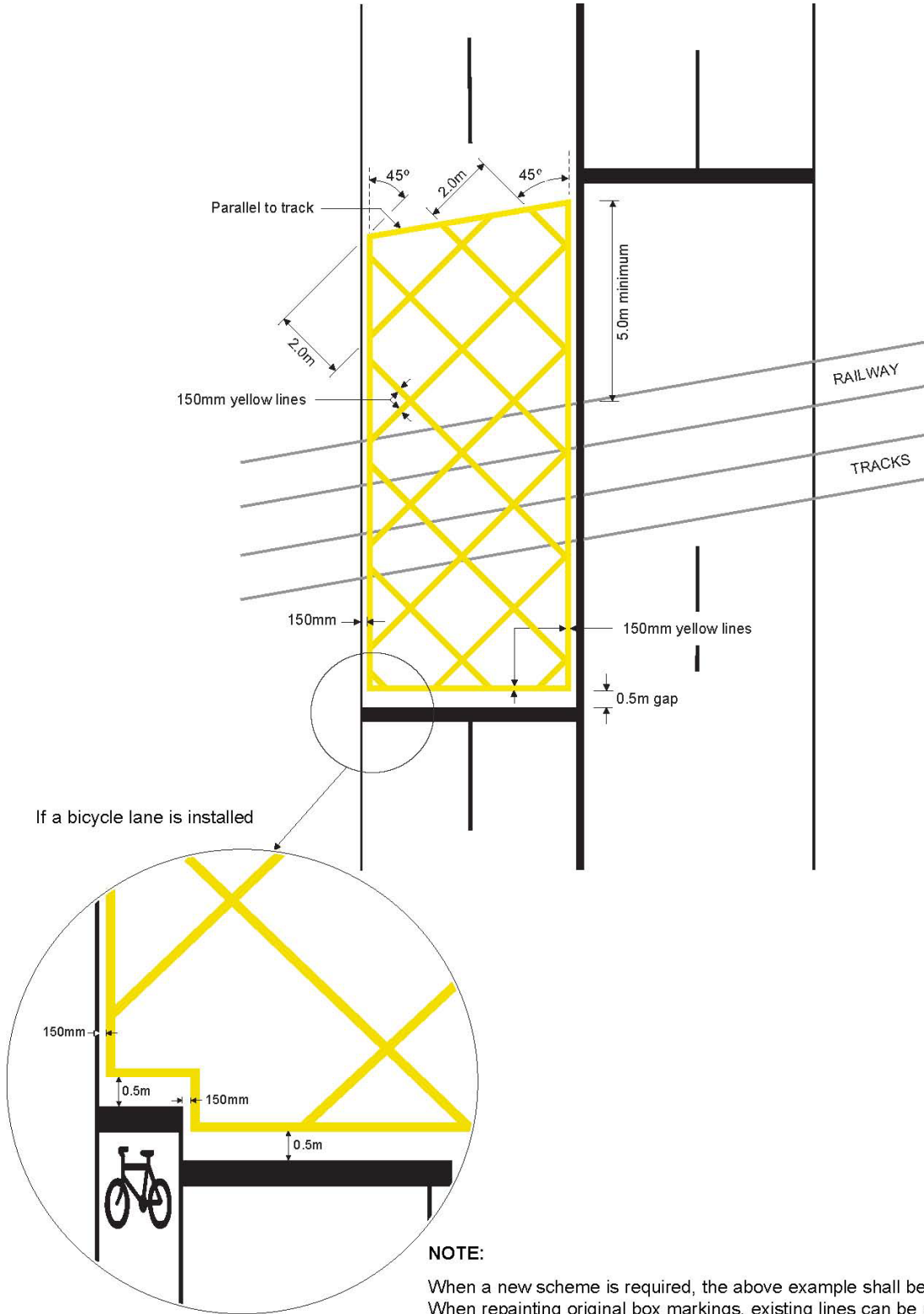

Refer to *GTM Part 10* and *AS 1742.7* for the warrants for box (cross-hatched) markings. Refer to *ARR Rule 120* for rules relating to painted cross-hatching road markings.

2.1.11 ZIGZAG SCHOOL ZONE MARKINGS

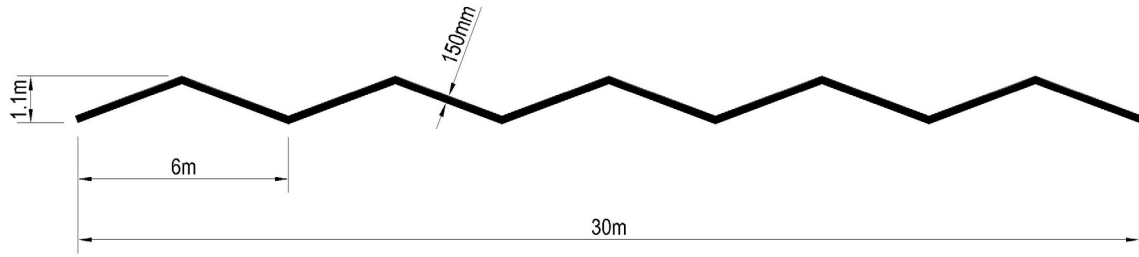

NOTE: ZIGZAG marking commences 30m in advance of School Zone Sign.

2.1.12 POINT TO POINT SAFETY CAMERA MARKINGS (STUB LINE)

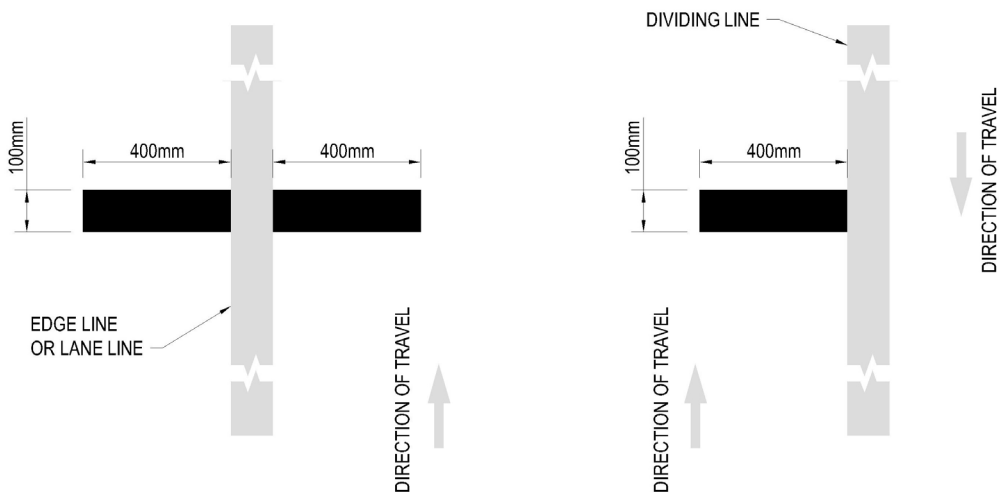

2.1.13 RAISED ROAD PAVEMENT MARKINGS

2.1.13.1 On street

Reference: AS 1742.2 Figure 5.15

Includes Flat-top Road Humps, Watts profile (3.7m length), Wombat Crossings (on street and off street) and Raised Intersections.

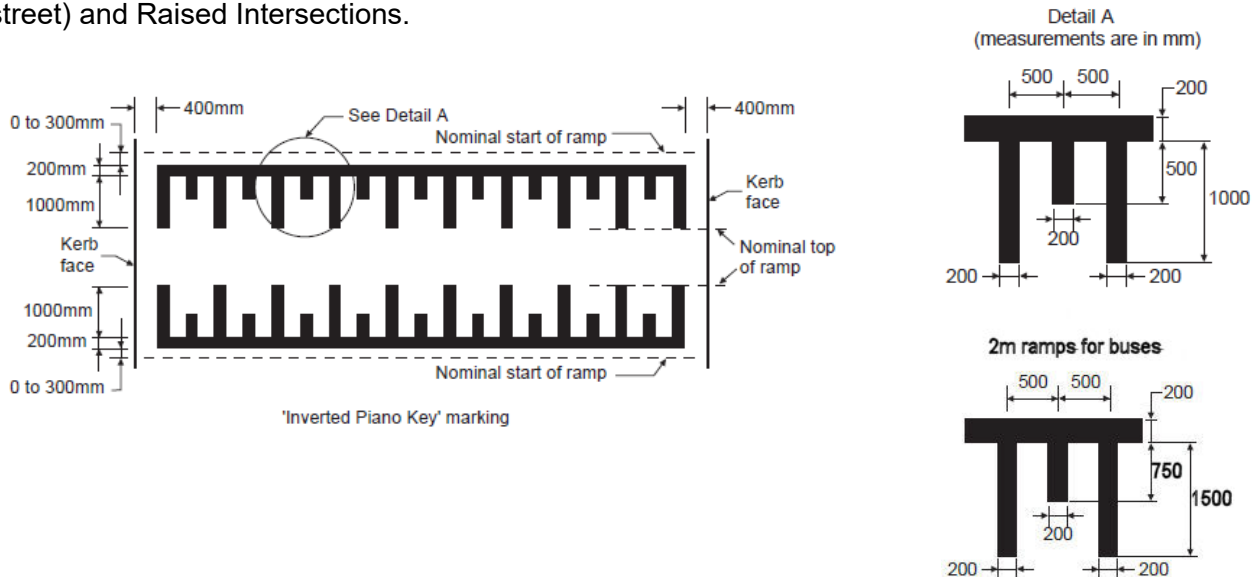

RAISED ROAD PAVEMENT MARKINGS (continued)

2.1.13.2 Off street (Watts profile 1.2m length only)

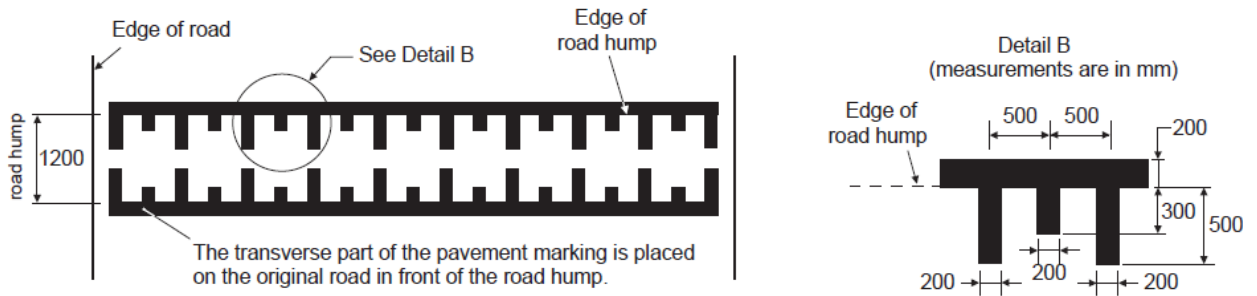

2.1.14 PAVEMENT BARS

Reference: DIT Master Specification RD-LM-S1. Section 11; *AS 1742.2 Clause 5.10.*

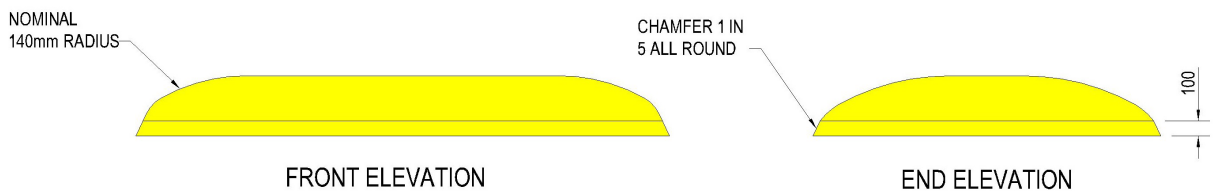
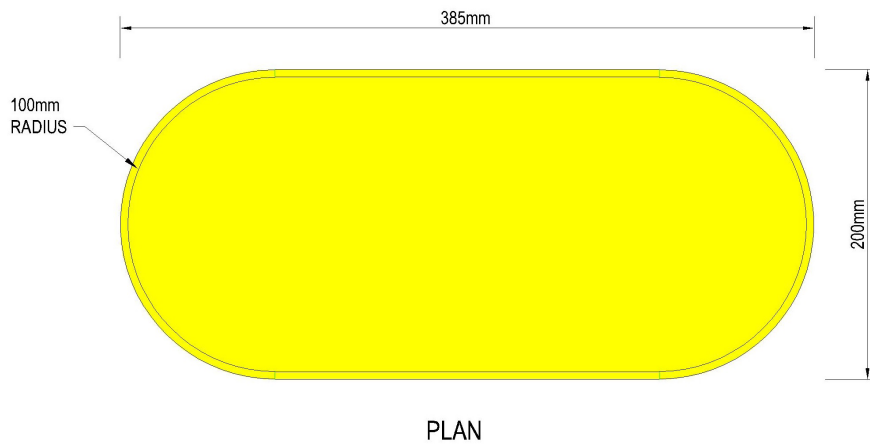

NOTE: Not to scale. Size B Bars 50mm nominal height.

PAVEMENT BARS (continued)

Single row



Double row, triple row etc

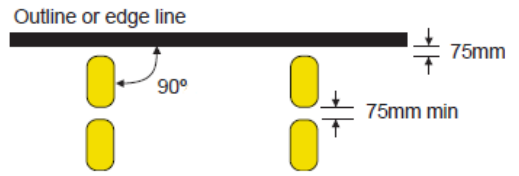

Control of turning movements at intersections

Pavement bars shall not be used where 85th percentile approach speeds* are greater than 75 km/h. The use of yellow Retroreflective Raised Pavement Markers (RRPMs) is an alternative. **See 2.1.15.9 inset.**

Standard pavement bar median may be supplemented by RRPMs where physical turning control is less important. **See 2.1.15.9**

Pavement bars shall always be placed at 90 degrees to the direction of traffic.

* 85th percentile speed (V85 km/h) - the speed at or below which 85% of vehicles are observed to travel under free-flowing conditions past a nominated point. A vehicle is considered to be operating under free-flowing conditions when the preceding vehicle has at least 4 sec headway and there is no apparent attempt to overtake the vehicle ahead.

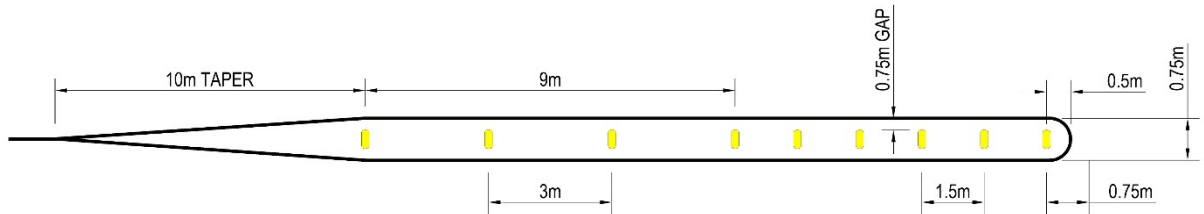

NOTE: The 9 m length using 4 bars at 3 m spacing may be extended to 18 m using 7 bars at 3 m spacing. This layout may be shortened if used on low-speed local streets.

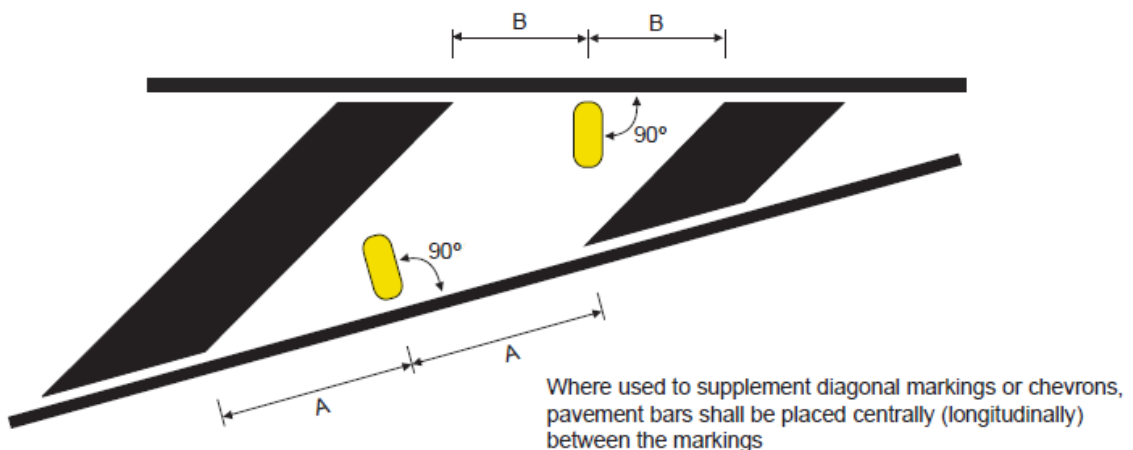

2.1.15 RAISED PAVEMENT MARKERS





Reference AS 1742.2 Clause 5.9.

Colour of retroreflective raised pavement markers to augment painted lines:

Applications	RRPM Colour
Lane lines, small * channelizing outline Painted or raised – all sides	White
Left hand edge line, divided and 2-way roads. Left side of diverge outline, including expressway exit nose, and approach end of large island.	Red
Dividing lines, right hand edge line (divided road), median island outline, painted or raised - all sides. Tram lane lines. Right side (when viewed in the direction of travel) of exit lane on diverge outline, including expressway exit nose, and approach end of large island.	Yellow

* A small island should generally be regarded as one with no side longer than 3 m including approach and departure markings.

Symbols for raised pavement markers:

Marker	Symbol
Reflective pavement dot	
Retroreflective raised pavement marker:	
Unidirectional	White 
Unidirectional	Yellow 
Unidirectional	Red 
Bidirectional	Yellow 

* Line extension on symbol indicates direction of reflection. Face of marker to be normal to direction of travel.

RAISED PAVEMENT MARKERS (continued)

2.1.15.1 Dividing and Barrier lines (separates opposing traffic flows only)

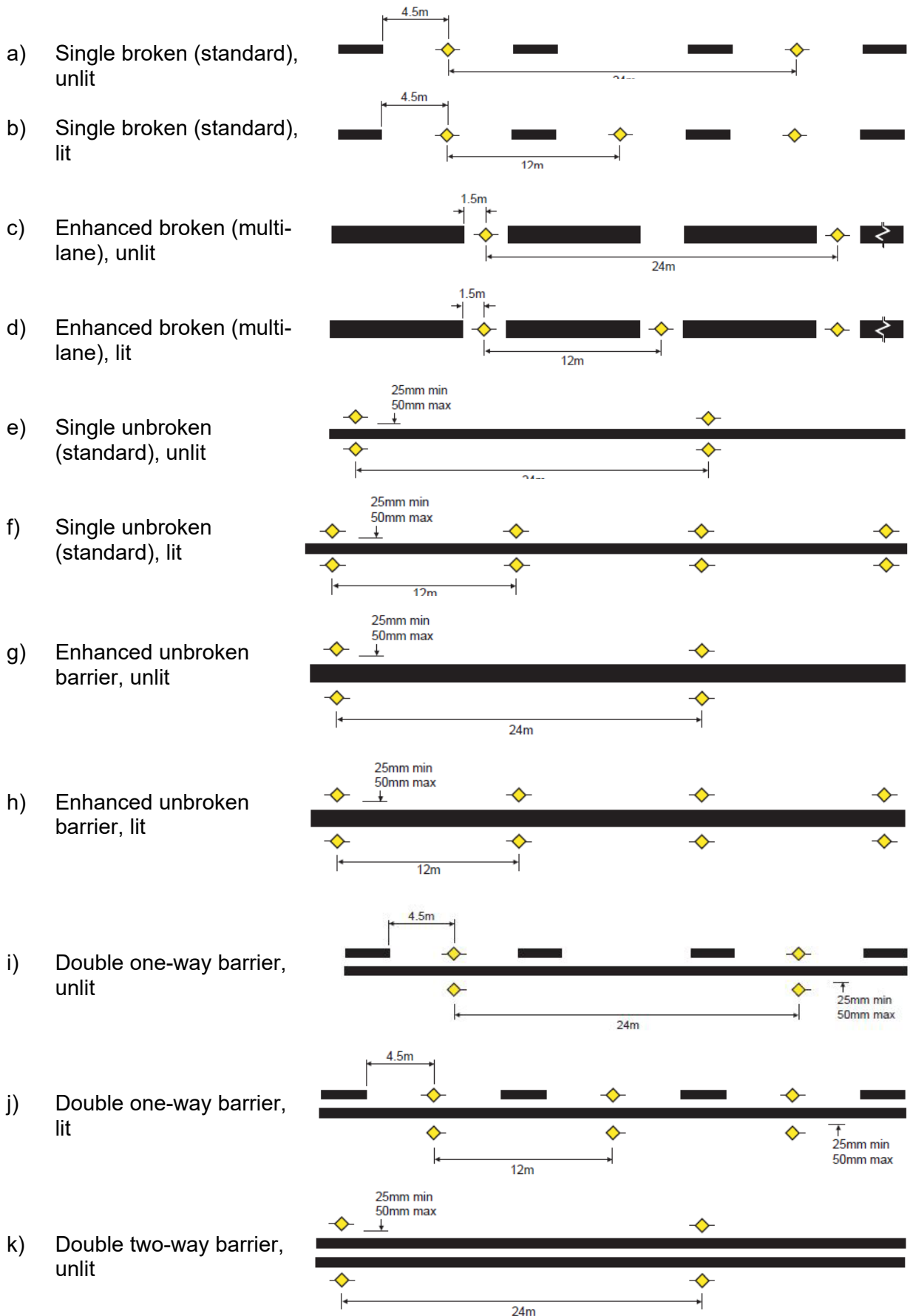

RAISED PAVEMENT MARKERS (continued)

l) Double two-way barrier, lit



m) Outline urban roads, unlit

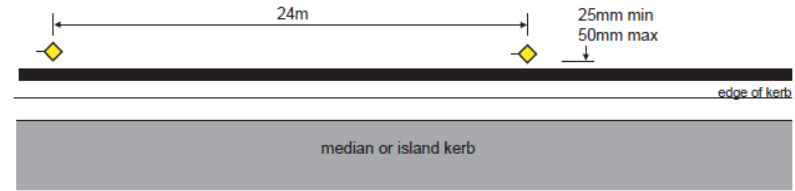

n) Outline urban roads, lit

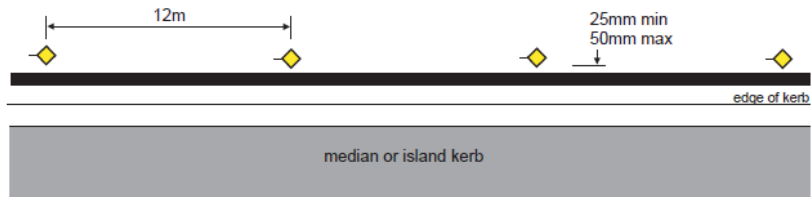

o) Enhanced outline rural roads, motorways, freeways and expressway, unlit where sufficient width permits

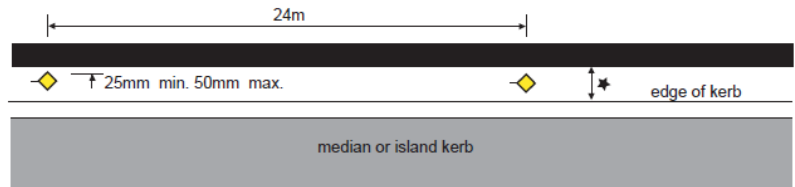

p) Enhanced outline rural roads, motorways, freeways and expressway, lit where sufficient width permits

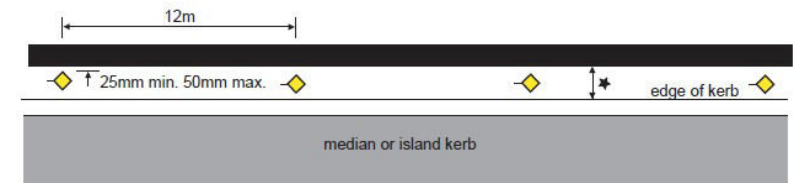

q) Wide centre line (double broken)

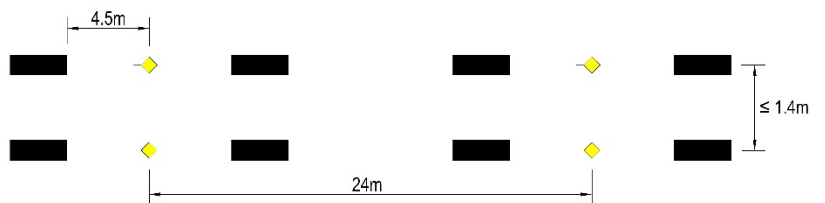

r) Wide centre line (double one-way barrier)

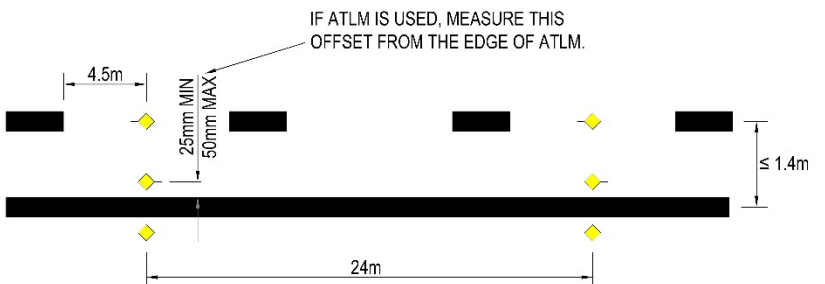

RAISED PAVEMENT MARKERS (continued)

- s) Wide centre line (double two-way barrier)

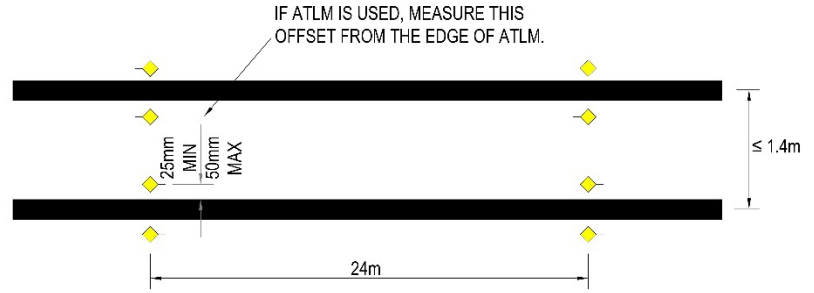

NOTE: If wide centre line treatment is narrower than 1.0 m, RRPMS between the double two-way barrier lines may be positioned in line with the ATLM (between the ATLM ribs) e.g. Riddoch Highway.

2.1.15.2 Lane lines

- a) Broken, unlit

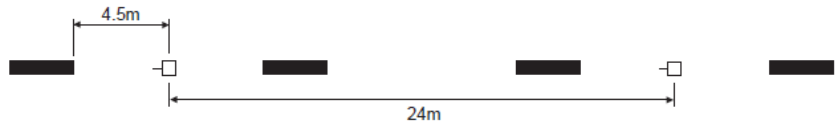

- b) Broken, lit

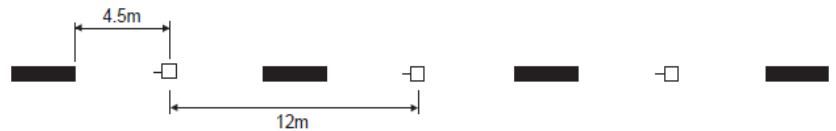

- c) Continuous, unlit.
Markers may be on left or right of line.



- d) Continuous, lit.
Markers may be on left or right of line.



- e) Special purpose lane line, unlit



- f) Special purpose lane line, lit

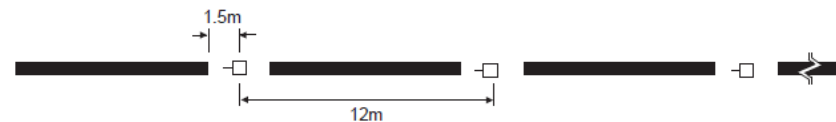

NOTE: Direction of travel is left to right in above diagrams.

RAISED PAVEMENT MARKERS (continued)

2.1.15.3 Edge lines (without offset ATLM)

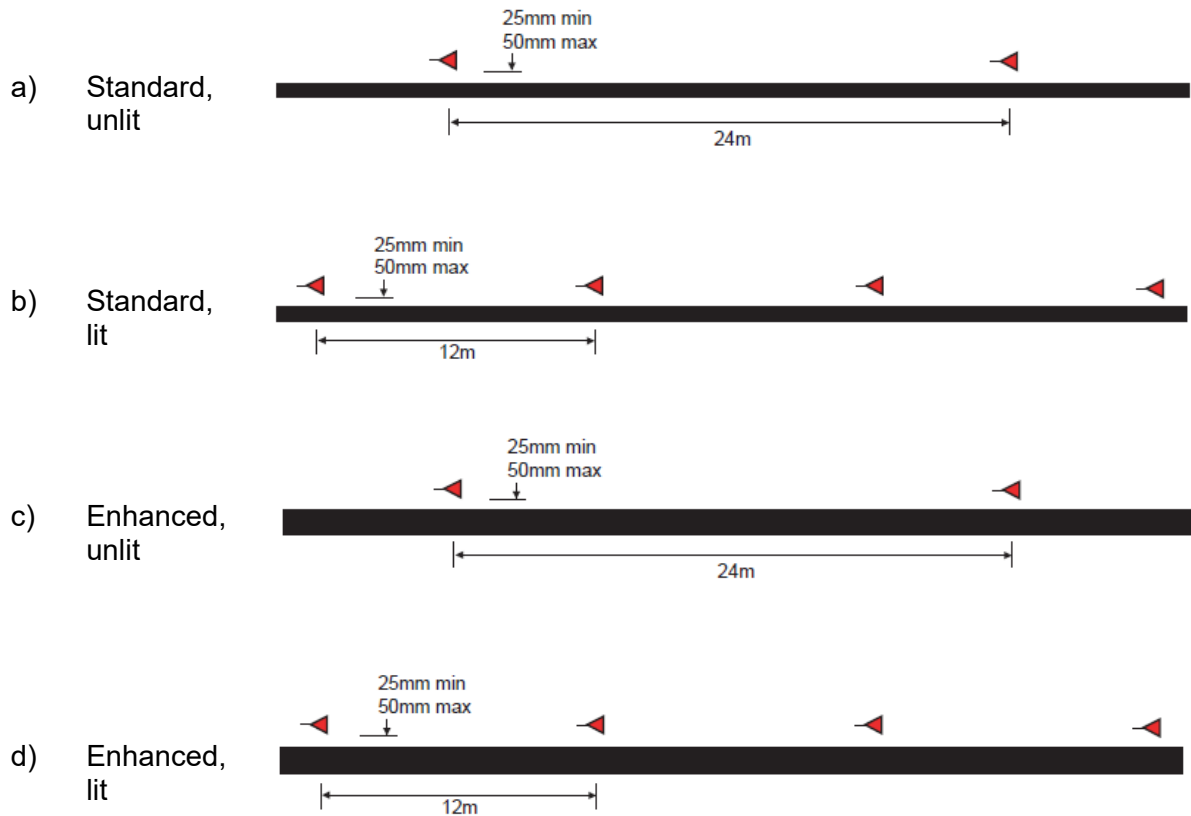

NOTES:

1. Direction of travel is left to right in above diagrams.
2. Edge lines in the merge taper on overtaking lanes from this specification, **see 2.1.15.10**.
3. RRPM shall not be used on narrow sealed shoulders of 0.2 m or less but if required can be installed on the line.
4. RRPM shall be placed to the left of the edge line (direction of travel) where there is the sealed shoulder width of > 0.2 m or left of the offset ATLM where it is installed. *Refer to OI 2.13.*
5. If a bike lane exists and RRPMS are required then they shall be installed on the edge line or to the right of the edge line for the direction of travel. RRPMS shall not be installed in the bike lane.

RAISED PAVEMENT MARKERS (continued)

2.1.15.4 Corner islands

NOTE: Raised island/median noses are painted unless RRPMs surrounding the median are installed or a sign is installed highlighting the raised island/median nose. On roads with edge lines (standard or enhanced) red RRPMs should be located on the other side of the corner island outline.

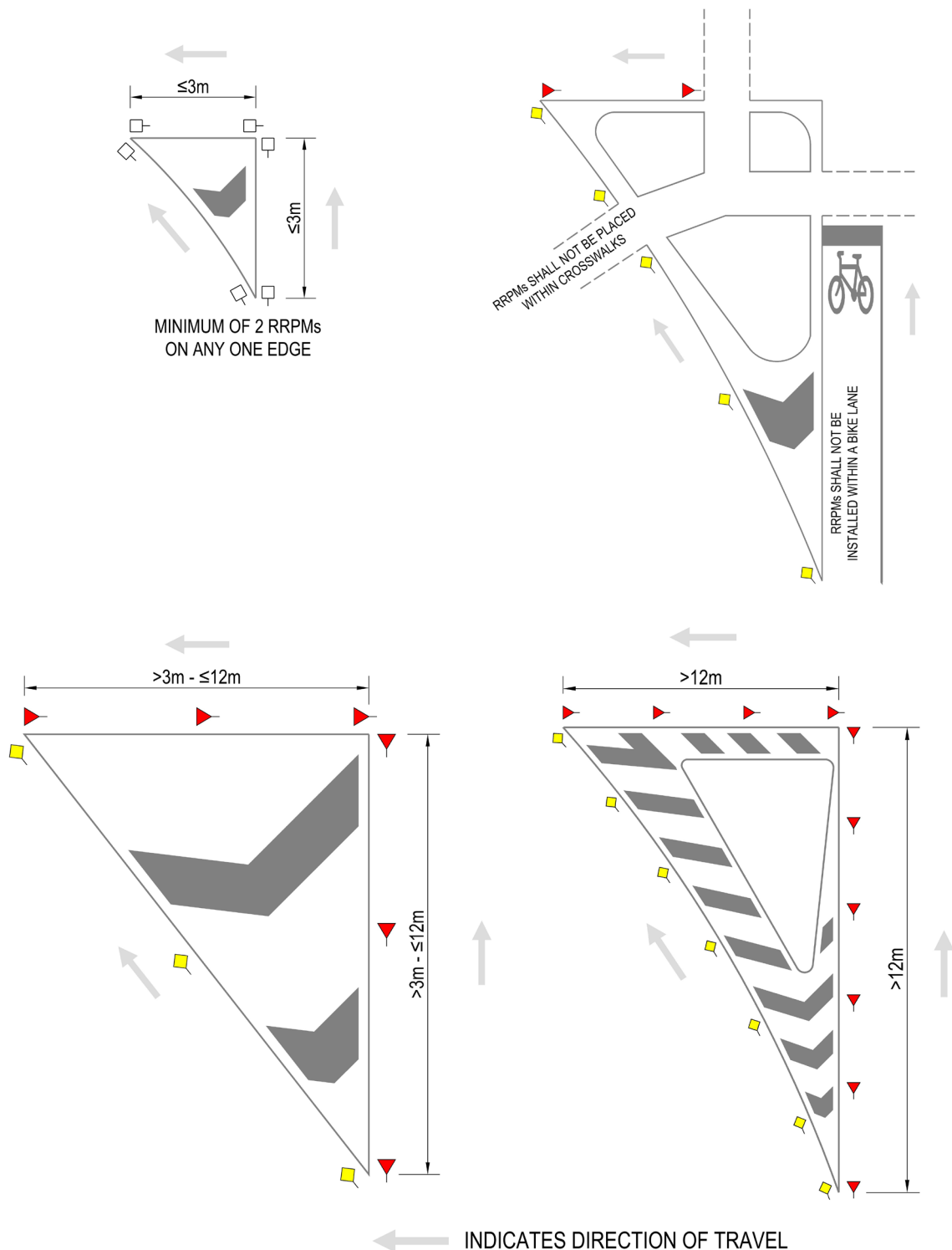

RAISED PAVEMENT MARKERS (continued)

2.1.15.5 Motorway/Freeway/Expressway type ramps

a) Preferred

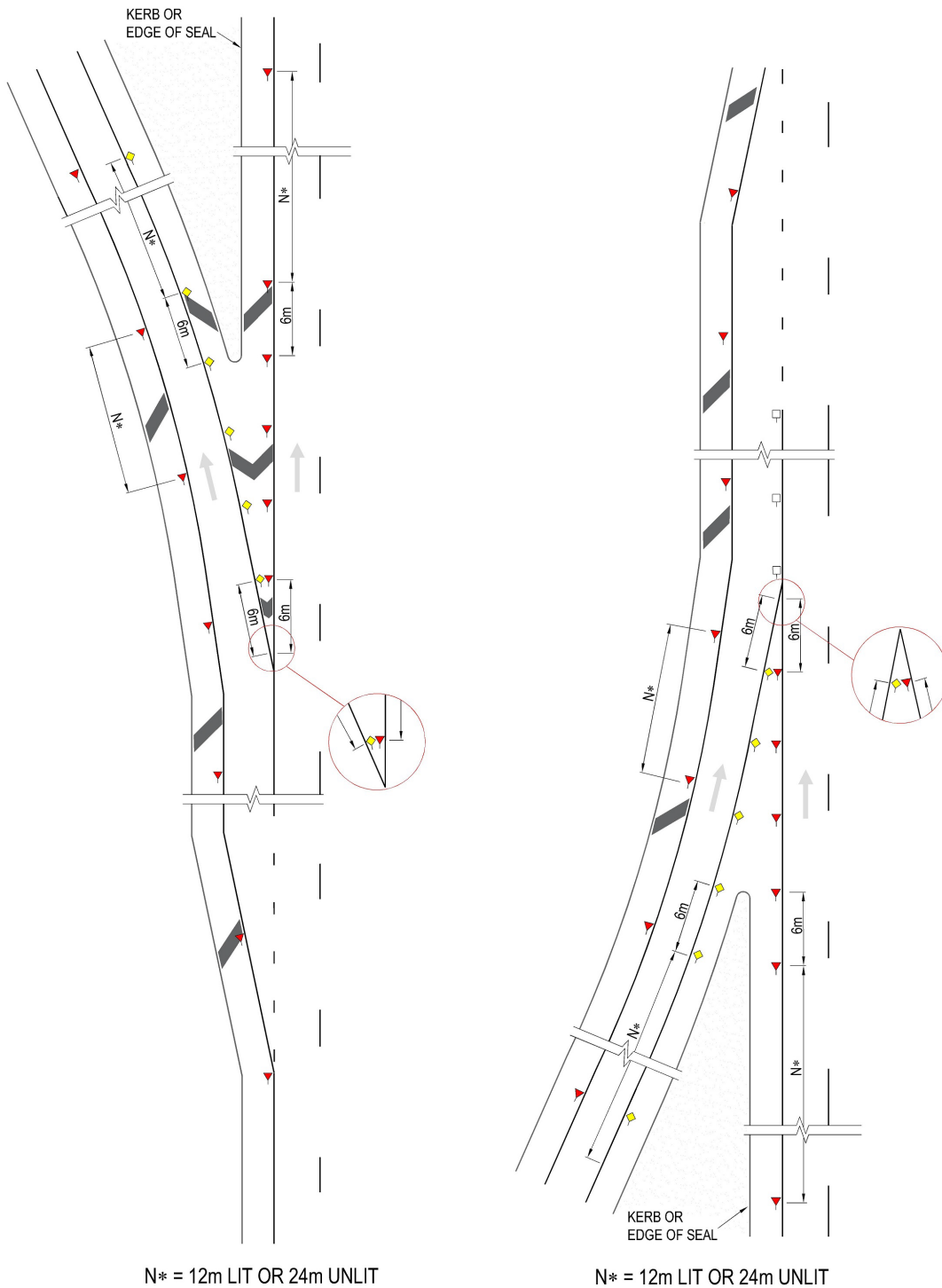

← INDICATES DIRECTION OF TRAVEL

NOTE: RRPMS should be placed on the median traffic island or shoulder side where sufficient pavement width permits.

RAISED PAVEMENT MARKERS (continued)

b) Alternative

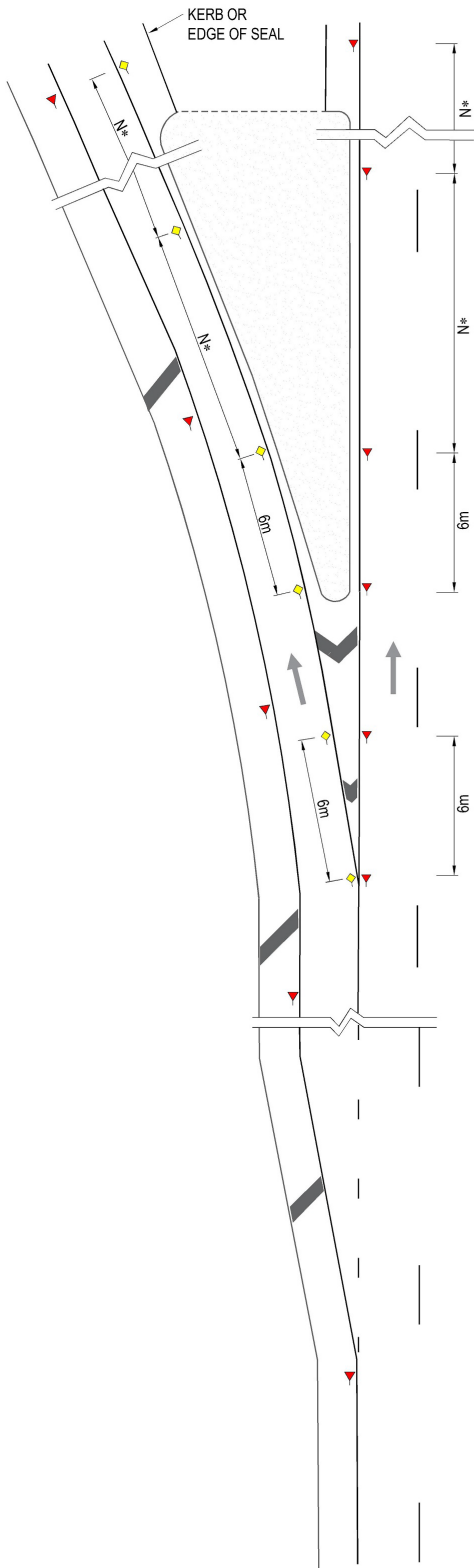

NOTE:
THIS TREATMENT NARROWS THE LANE
WIDTH AND MAY NOT BE CONSISTENT
WITH RRPM LOCATIONS BEFORE AND
AFTER RAMP.

$N^* = 12\text{m LIT OR } 24\text{m UNLIT}$

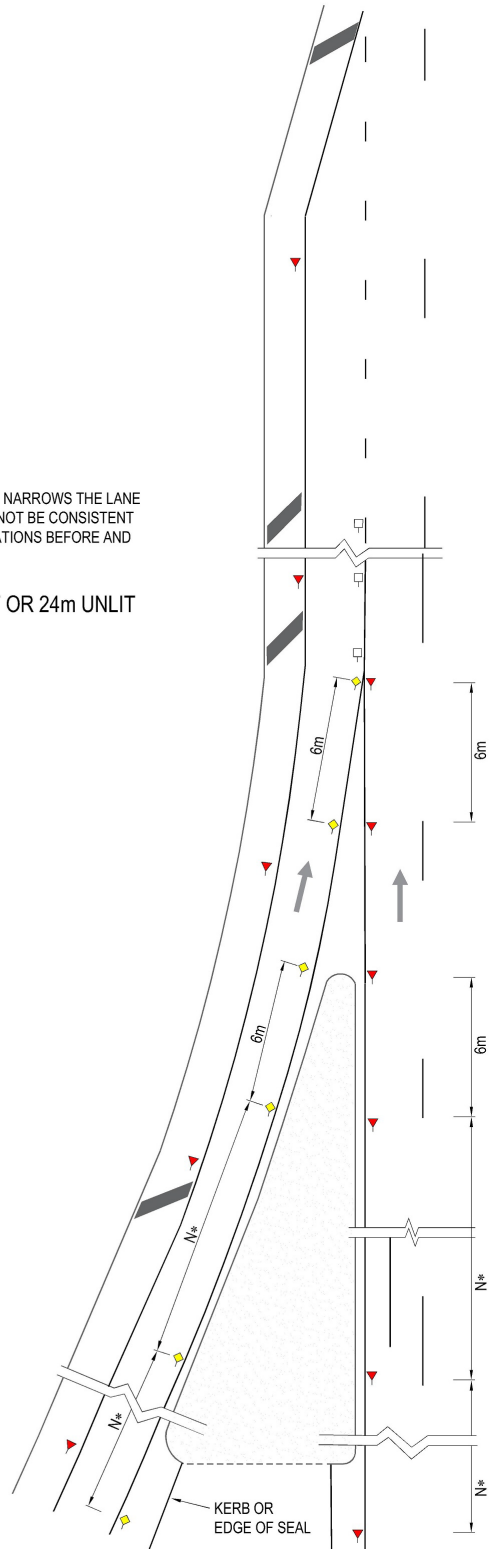

← INDICATES DIRECTION OF TRAVEL

RAISED PAVEMENT MARKERS (continued)

c) Two lane exit

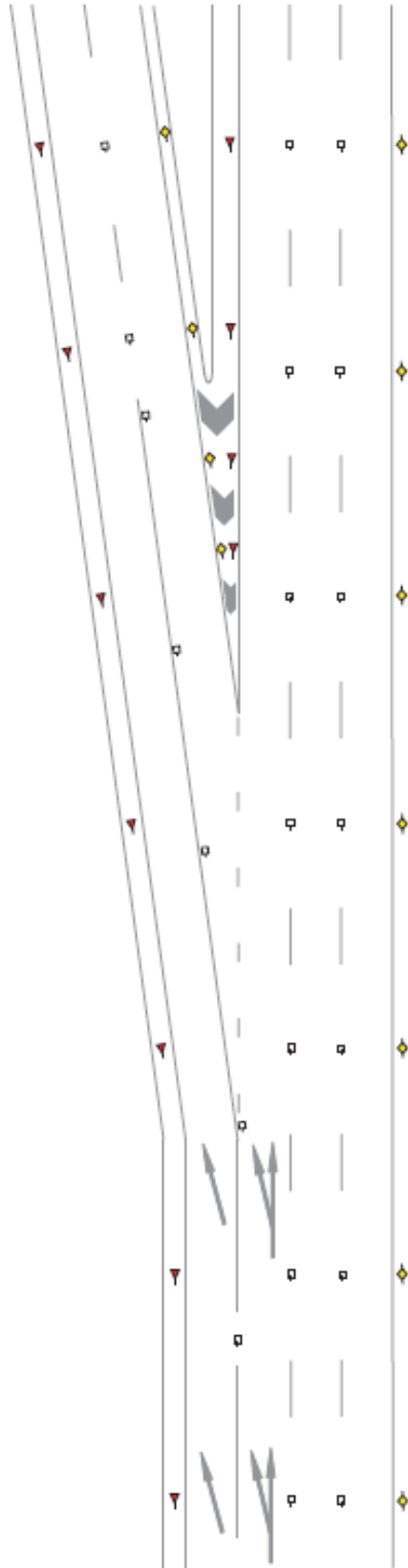

RAISED PAVEMENT MARKERS (continued)

2.1.15.6 Urban road

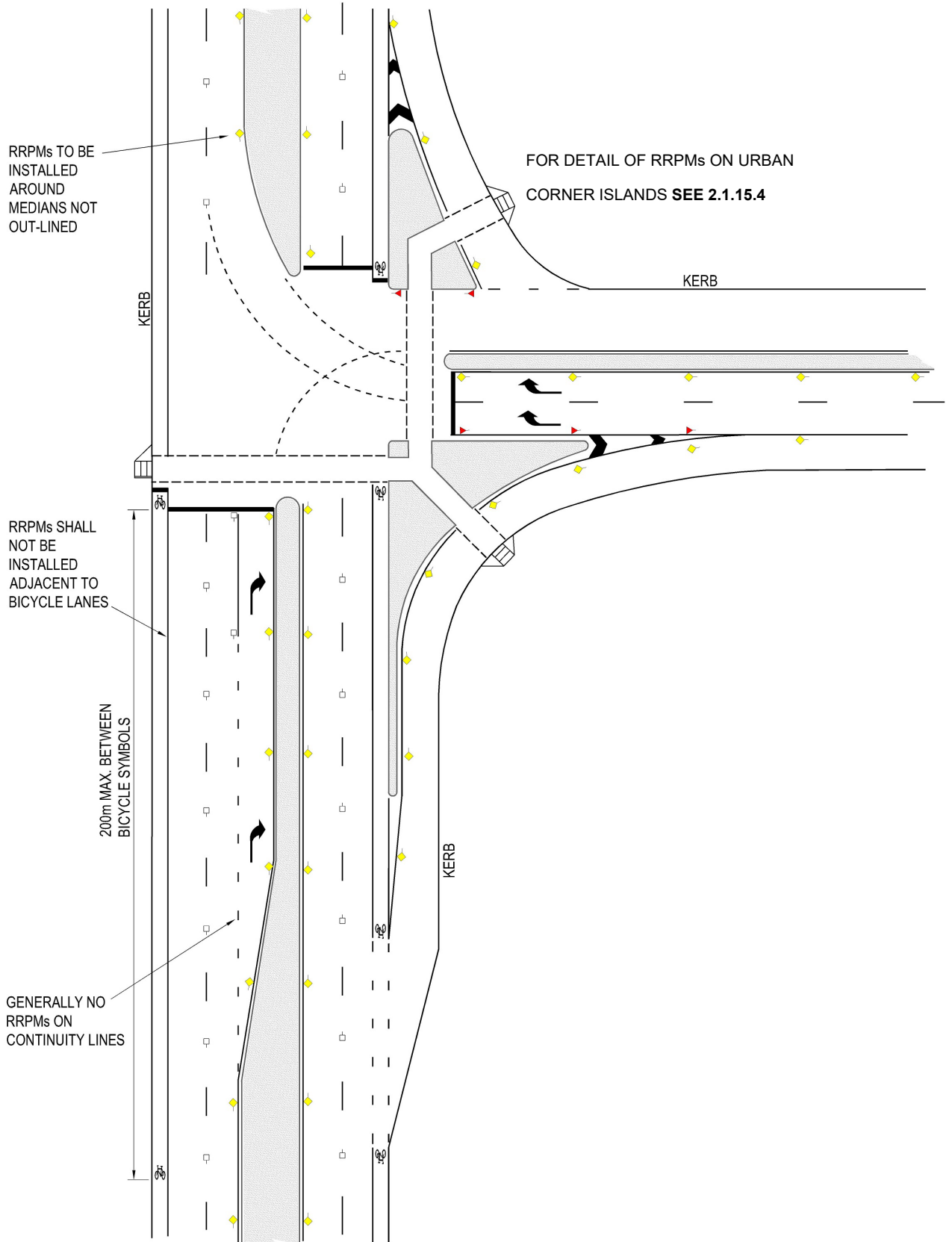

RAISED PAVEMENT MARKERS (continued)

2.1.15.7 Rural multi-lane road

NOTE:
IF THE INTERSECTION IS LIT, RRPM SPACING IS 12m

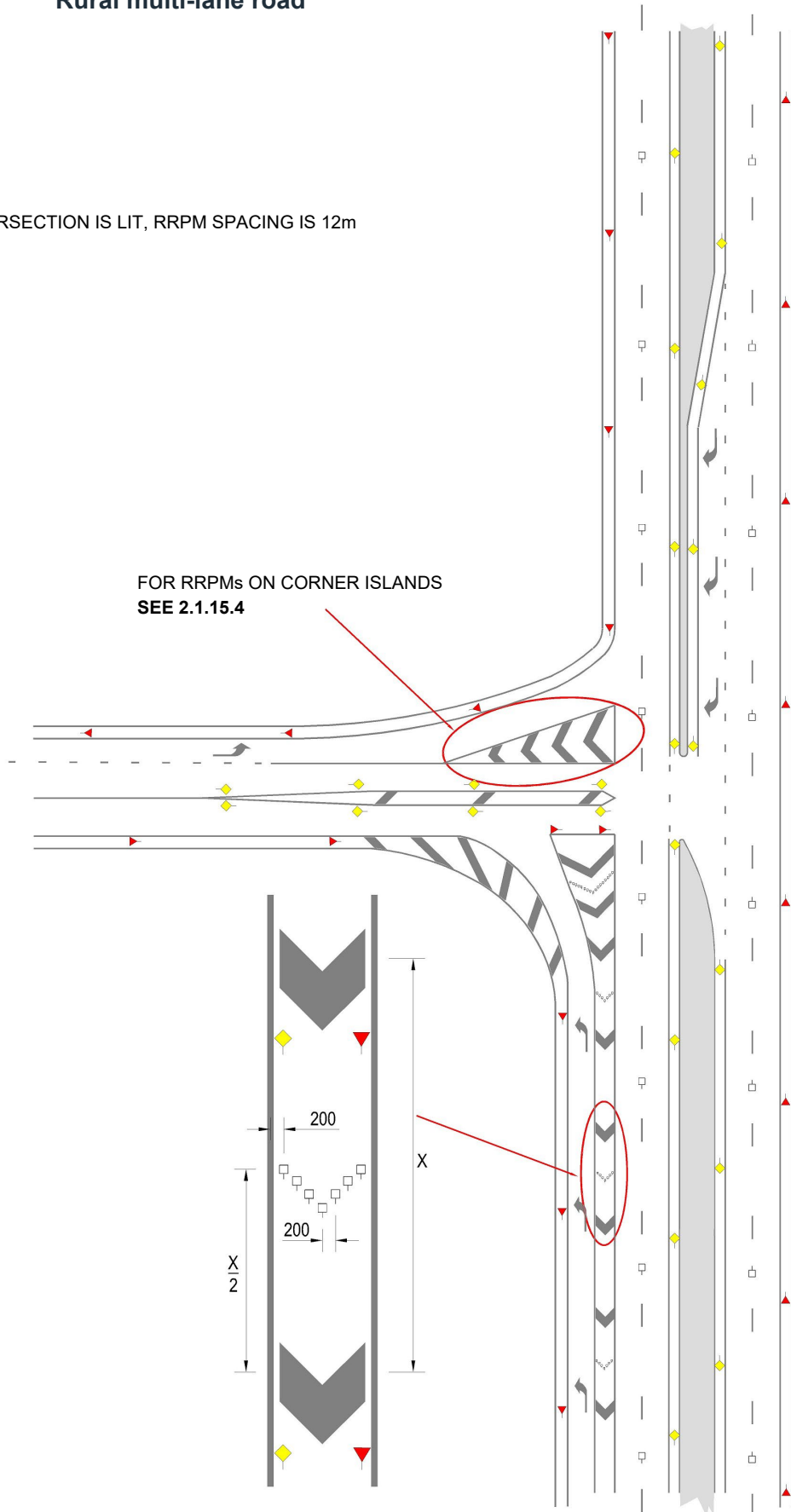

RAISED PAVEMENT MARKERS (continued)

2.1.15.8 Rural two-lane two-way road

NOTES:

1. Dividing lines on intersection approaches RRPMs at 12m intervals. Refer AS 1742.2 Table 5.7.
2. Continuity line may be used across side roads, **see 3.3.11.3**.
3. For edge lines also **see 3.4.7**.

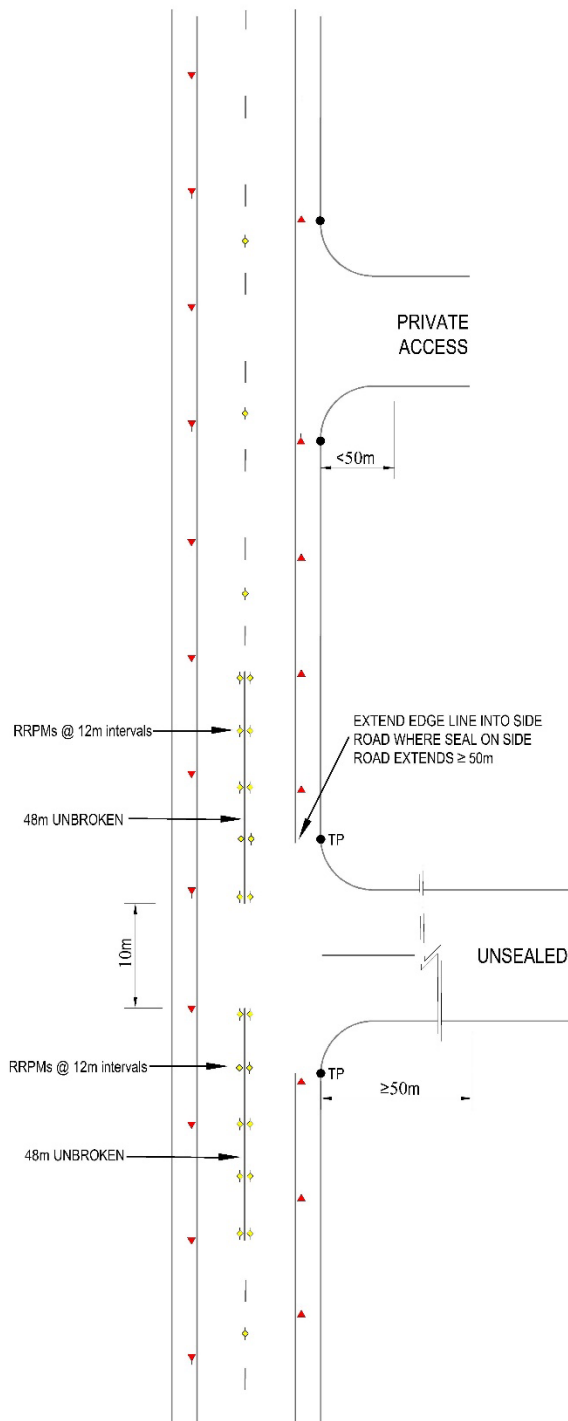

RAISED PAVEMENT MARKERS (continued)

2.1.15.9 Rural intersection

a) Auxiliary left turn (AUL)

b) Channelised right turn (CHR and CHR/S)

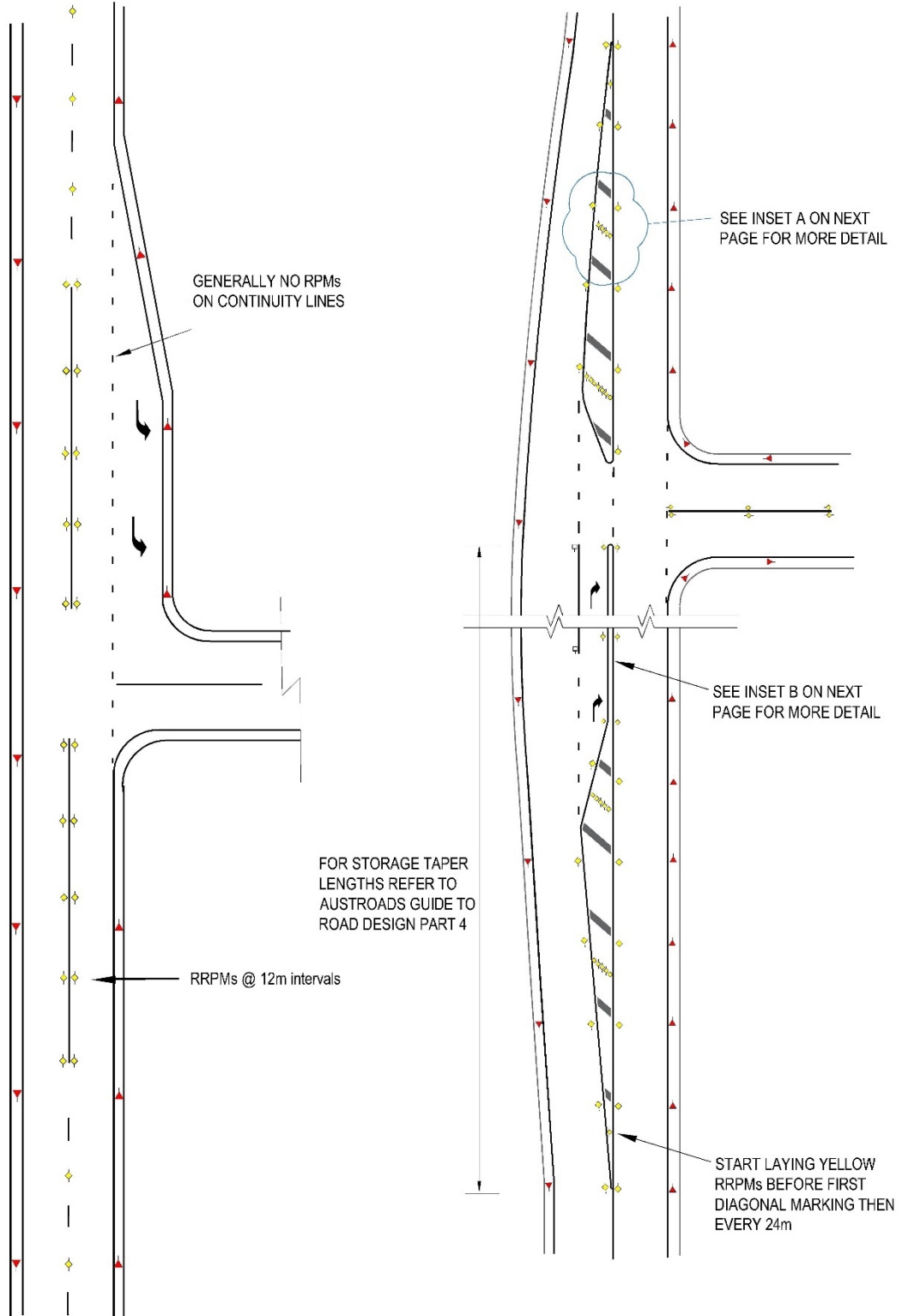

RAISED PAVEMENT MARKERS (continued)

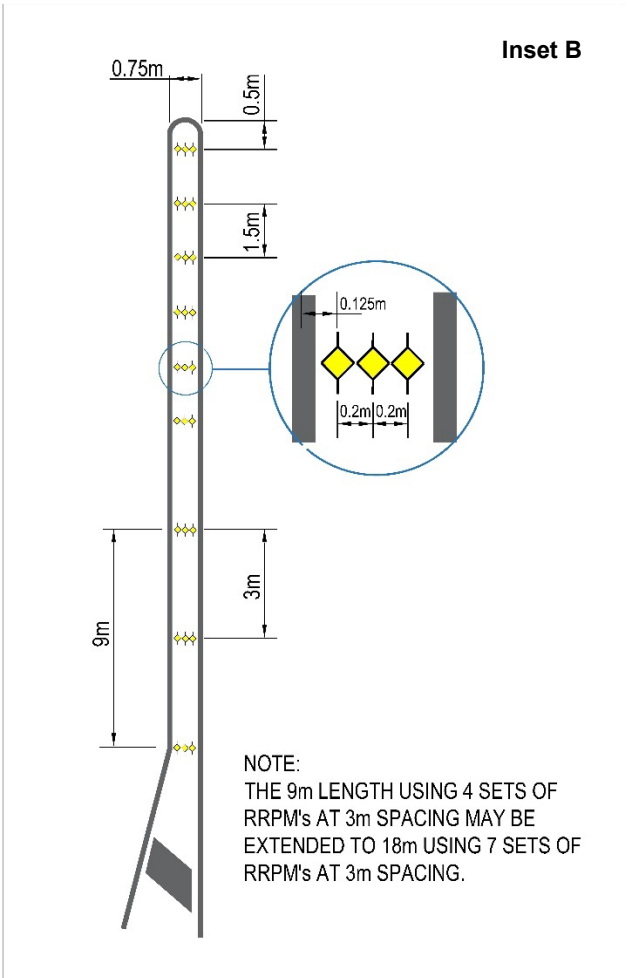
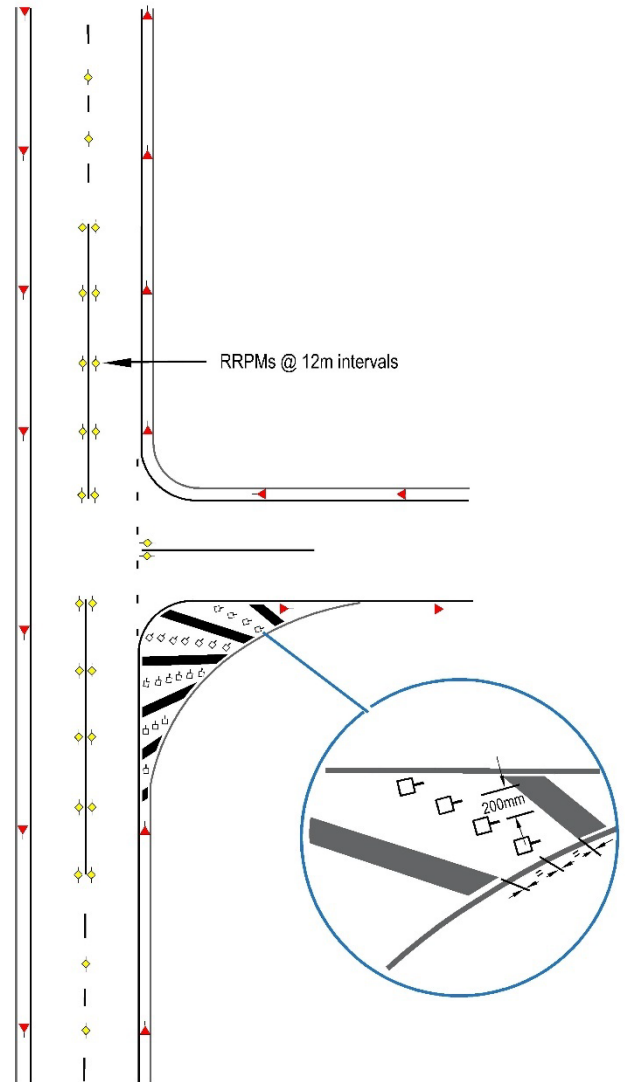
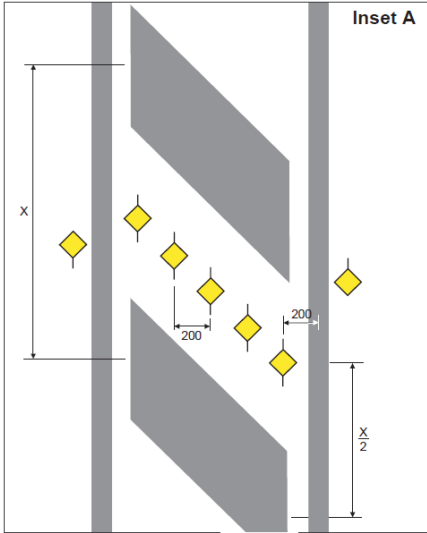

RAISED PAVEMENT MARKERS (continued)

2.1.15.10 Overtaking lane - merge area delineation treatment 80km/h or greater

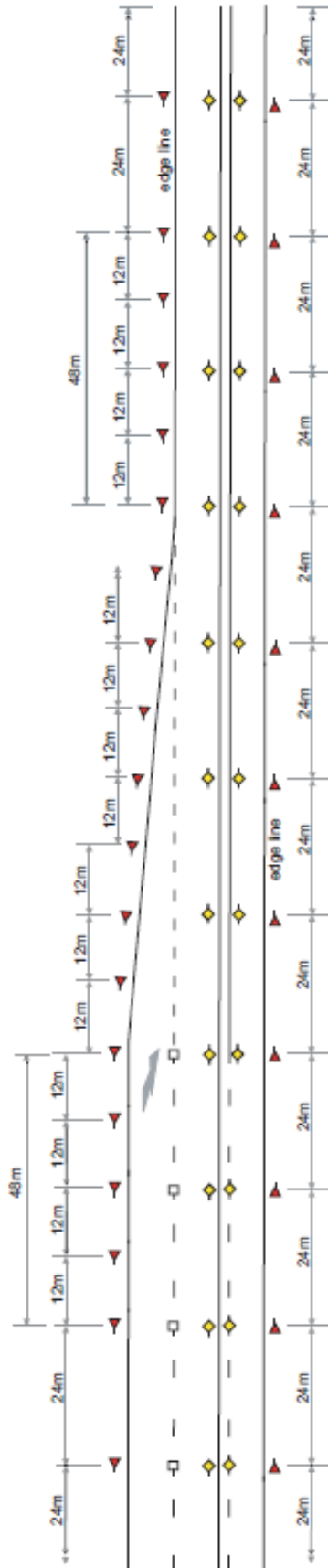

RAISED PAVEMENT MARKERS (continued)

2.1.15.11 Wide centre line treatment

Wide centre line treatment, **see 2.1.1.1.(g)**

For RRPMS past this point **see 2.1.15.1 (q), (r) and (s)**

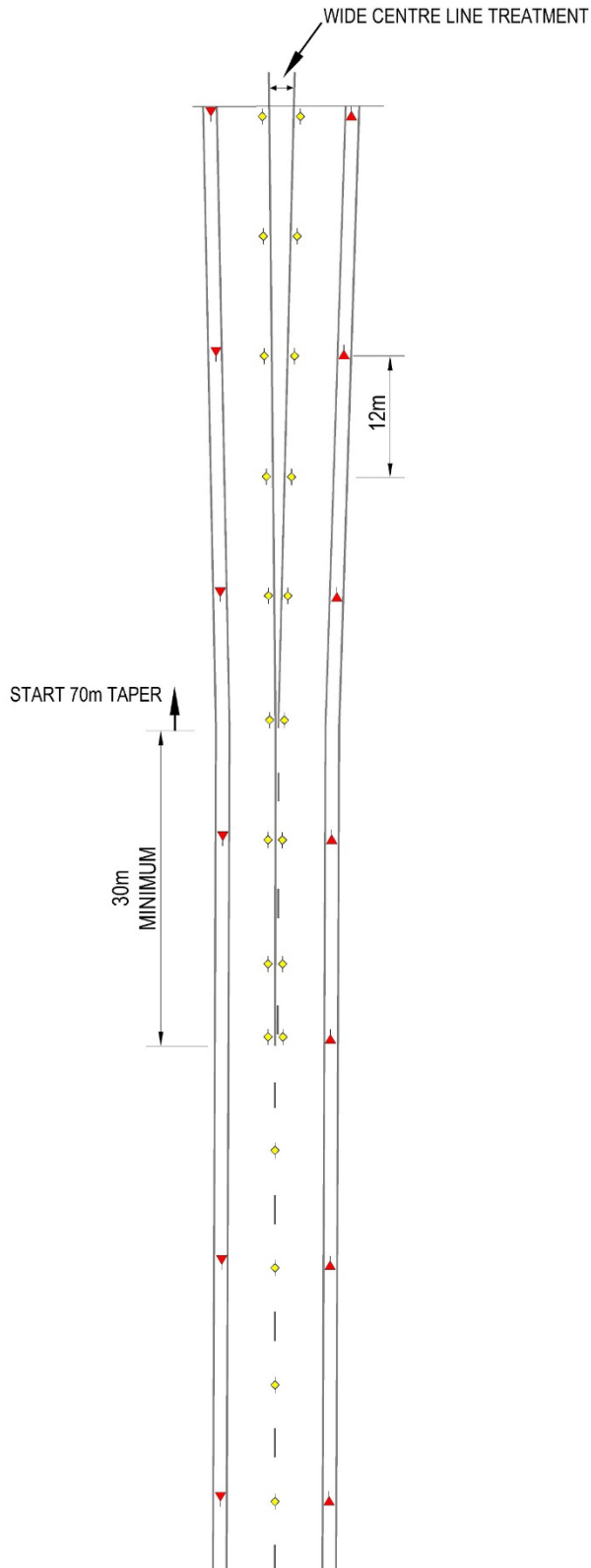

2.1.16 DISTINCTIVE COLOURED PAVEMENT AREAS

Only the following **AS 2700** colours shall be used:

- a) Bus Only areas (not bus lanes) - Red (Signal Red, R13) **see 3.3.26**
- b) Bicycle lanes - Green (Emerald, G13) **see 3.3.27**
- c) Full time signalised pedestrian crossings (only) - Yellow (Golden Yellow, Y14).
- d) Accessible boarding indicator patch and identification of dedicated parking spaces for people with disabilities - Blue (Ultramarine, B21) **see 2.1.8.8**.
- e) Islands and medians with diagonal stripes and chevron markings - Red (Terra Cotta, R52).

Distinctive coloured pavements for areas other than those stated above shall be referred to Manager, Traffic Services, DIT.

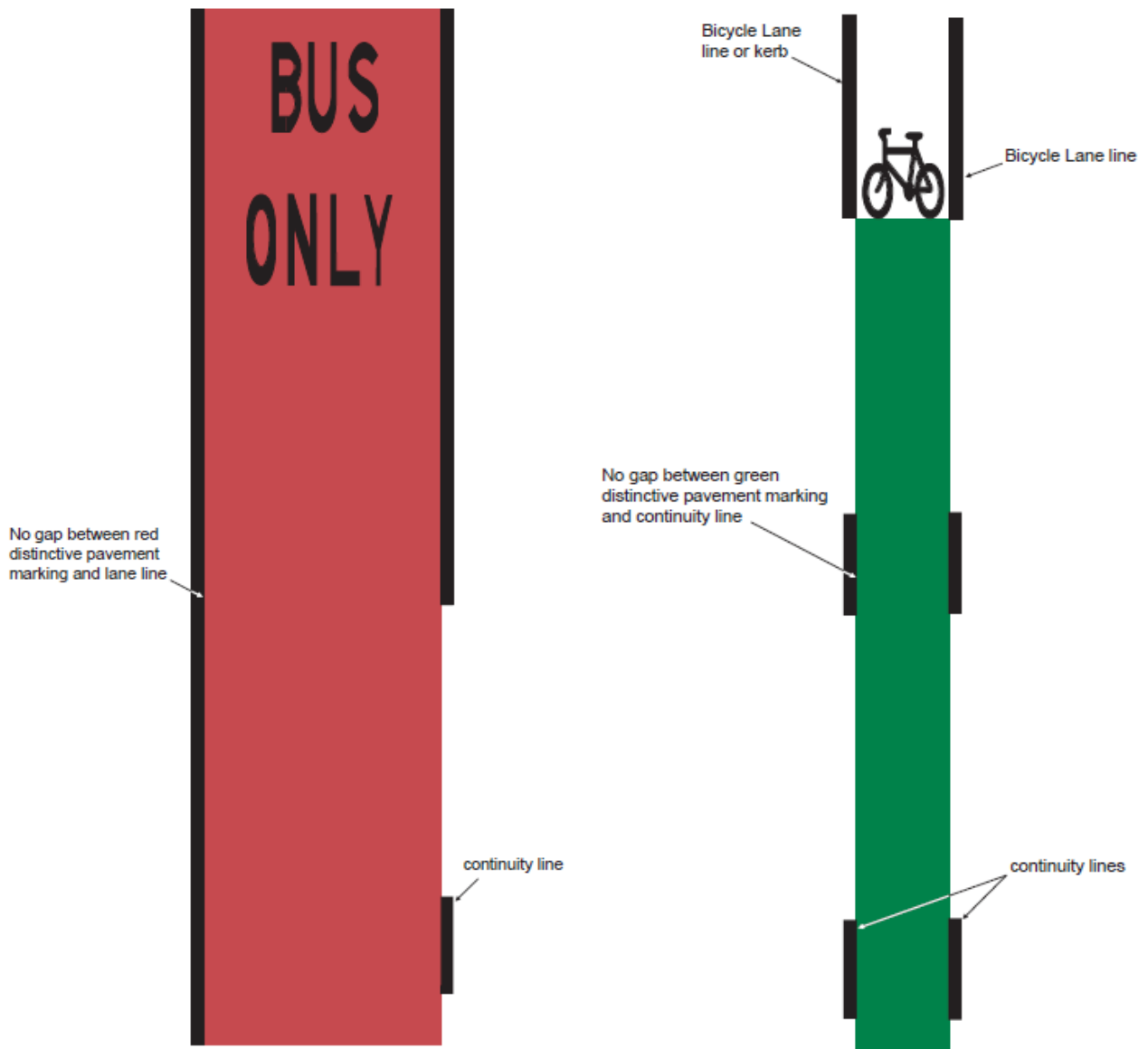

2.1.17 OUTLINES AND PAINTED KERBS

NOTES:

1. Painted kerbs shall be reflectorised.
2. Raised median kerbs shall be outlined 100 mm from kerb, where the adjacent through lane width is 3.0 m or greater in width.
3. Raised median kerbs shall be painted where the adjacent through lane width is less than 3.0 m.
4. Raised median kerbs in auxiliary right turn lanes shall not be outlined unless the right turn lane is greater than or equal to 3.0 m in width.
5. Raised islands, other than raised medians and roundabouts shall be outlined unless the adjacent lane is a bicycle lane less than or equal to 1.5 m wide.
6. Outlines on raised islands and medians shall be standard unbroken, except on roads where 150 mm edge lines are used. **See 2.1.1.8.**
7. Where back-to-back medians are installed the whole median shall be painted unless outlined.
8. Where kerb & gutter exists, edge lines are not required.
9. All raised median / island noses are painted.

2.1.17.1 Medians

Isolated openings in median kerbs left for drainage purposes shall not be painted.

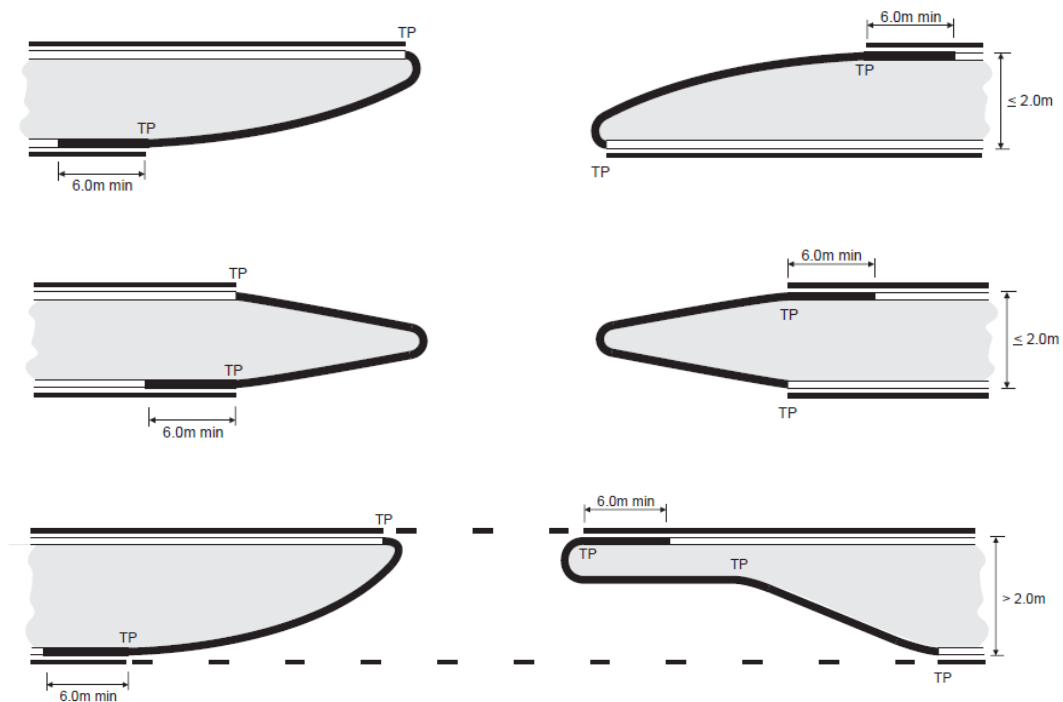

OUTLINES AND PAINTED KERBS (continued)

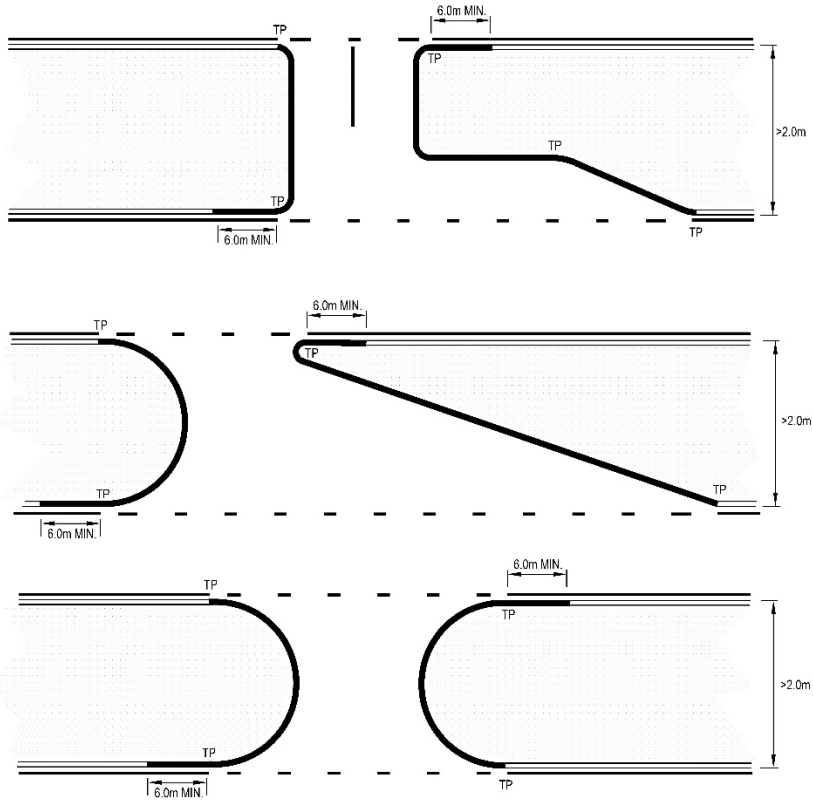

2.1.17.2 Roundabouts

Kerbs on roundabouts including standalone splitter islands and protuberances shall be fully painted. On roundabouts with provision for heavy vehicle movements i.e., with mountable or semi-mountable areas, the first 200mm of the mountable or semi-mountable area shall be painted white. The kerb of the central or main island in these circumstances may be painted.

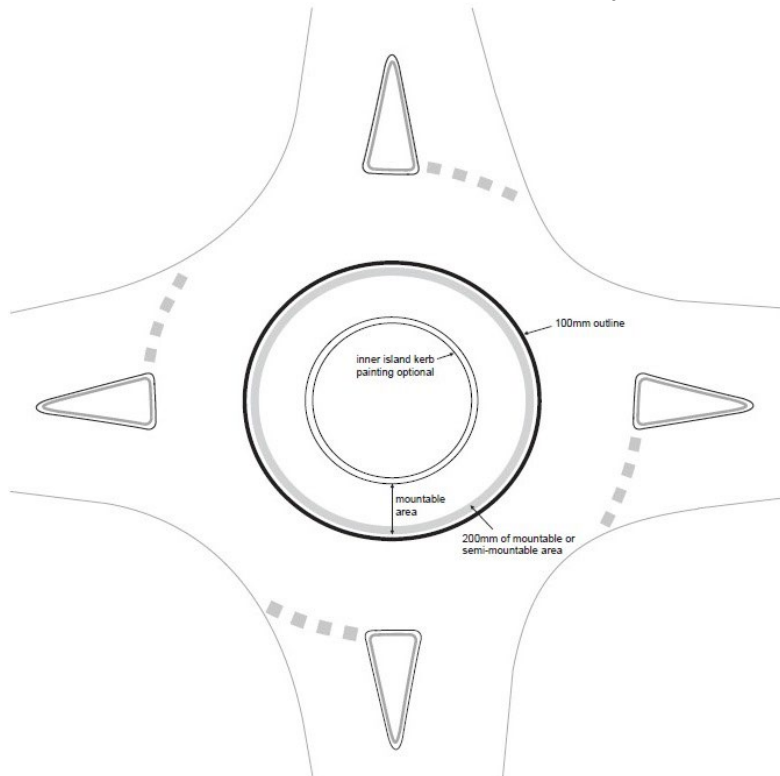

OUTLINES AND PAINTED KERBS (continued)

2.1.17.3 Through lanes and auxiliary right turn lanes

Outlines and median kerb painting for auxiliary right turn lanes <3.0m

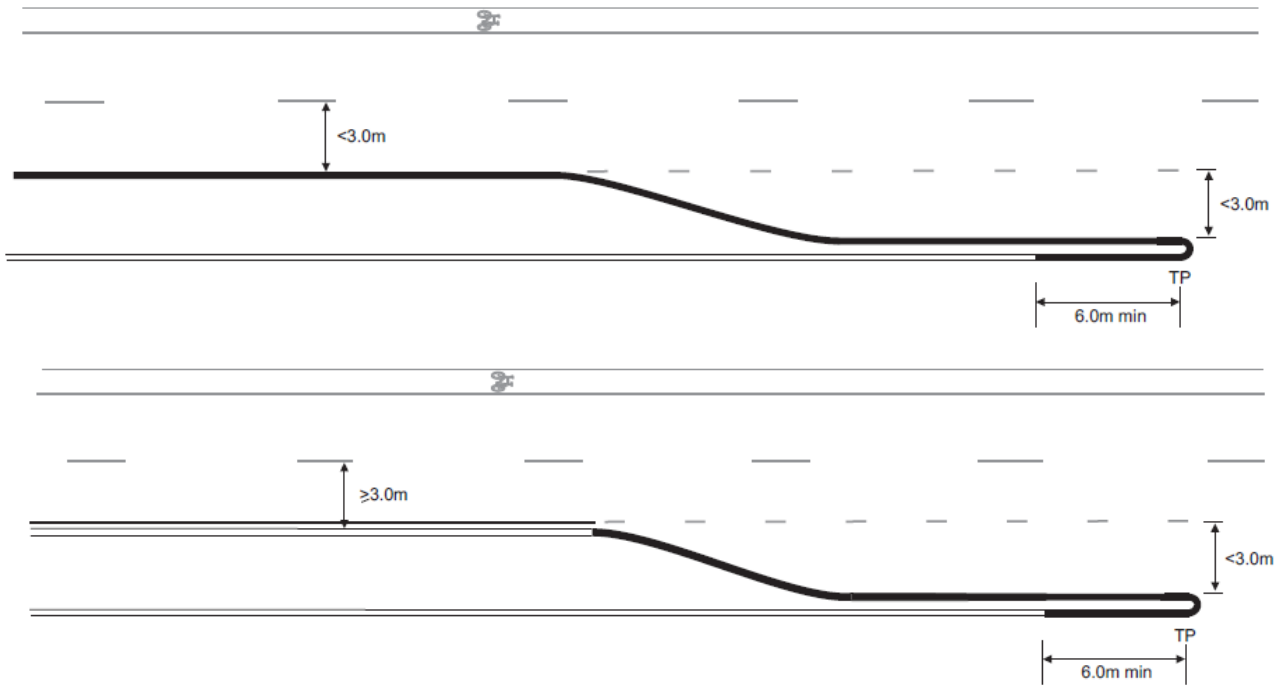

Outlines and median kerb painting for auxiliary right turn lanes >3.0m

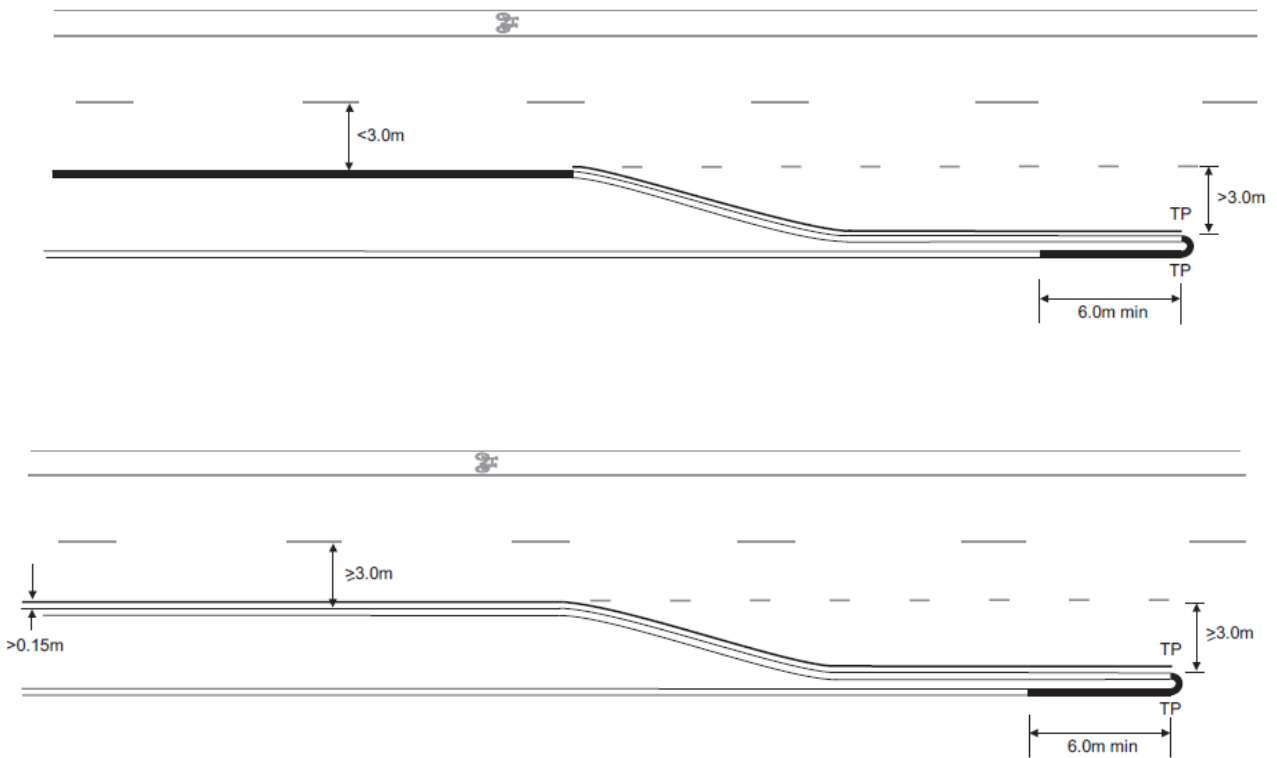

OUTLINES AND PAINTED KERBS (continued)

2.1.17.4 Other raised islands

Unless specified otherwise on traffic control drawings, the approach ends of traffic islands shall be painted white for a distance of 6 m. Exit ends of islands need not be painted. Where approach end of islands have outlines with diagonal markings or chevrons, kerbs need not be painted. Kerbs on islands with sides measuring less than or equal to 9 m (between end tangent points) shall be fully painted.

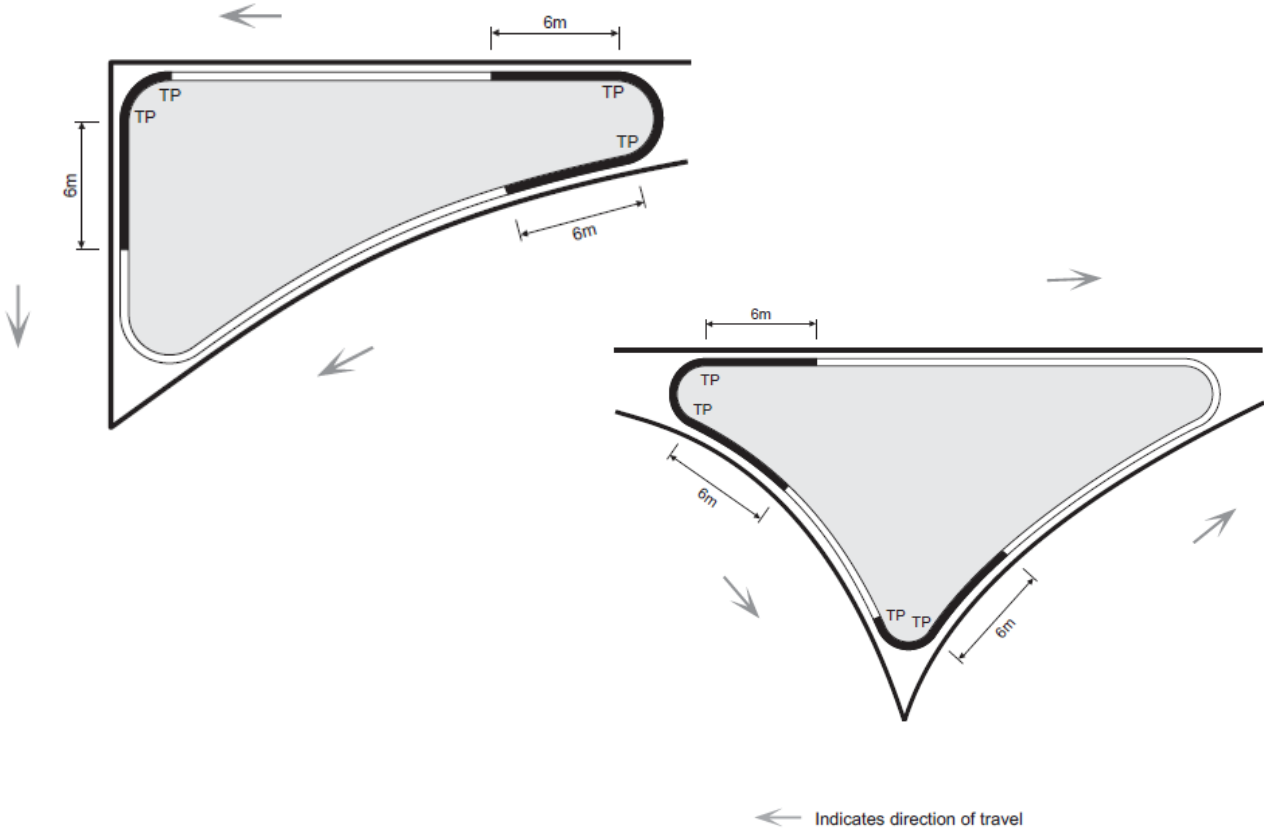

2.1.17.5 Pedestrian Refuges

For taper treatments **see 3.3.24.1**

Adjacent lane > 3.0 m

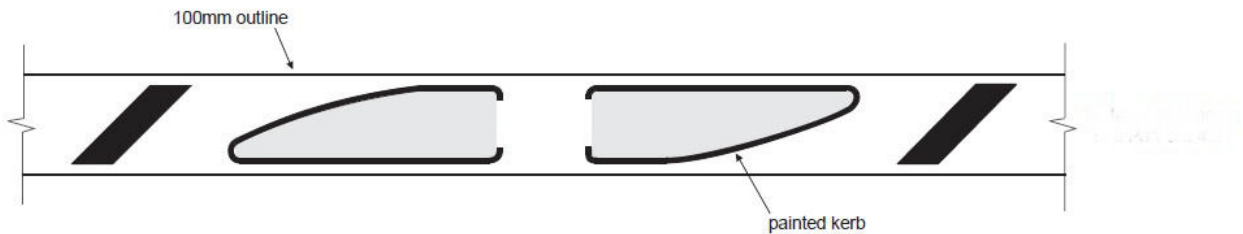

Adjacent lane < 3.0 m

As above but no outline, add line across opening as prolongation of kerb line.

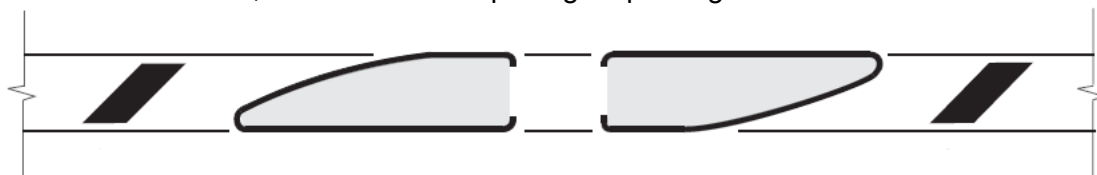

OUTLINES AND PAINTED KERBS (continued)**2.1.17.6 Local Area Traffic Management (LATM)**

For each length of median kerb 24 m or less, the entire kerb must be painted. Where the length of kerb is greater than 24 m, at least 6 m of kerb from each end must be painted.

The kerb is painted the full length where the width of the adjacent lane is less than 3 m. Otherwise the usual markings for medians apply.

It is not necessary to delineate the drainage channel formed by the existing kerb and kerb extensions, unless pedestrian safety is compromised, or it forms part of a by-pass of the device for cyclists.

Reference: Typical installations of RRPMs at LATM treatments are shown in AS 1742.13-2023.

2.1.18 BARRIER LINE INSTALLATION

Reference: AS 1742.2 Clause 5.3, and see 2.1.1.1, 2.1.5, 3.3.2, and 3.4.4

Where the road speed limit is 70 km/h or less and:

- Double two-way barrier lines are justified, then a single unbroken barrier line shall be used, including approaches to railway crossings and ferries. No gaps should be left for driveways or other accesses, only side roads.

Where the road speed limit is 80 km/h or more and:

- Double two-way barrier lines are justified, then double two-way barrier lines shall be used. Gaps should **only** be left in line marking for driveways, or other accesses and side roads **when they meet sight distance requirements. (However, existing approved gaps will need to be installed after reseals).**

2.1.18.1 Intersections

Gaps shall be provided in double two-way barrier lines and shall generally be 10 m wide and centrally placed at the intersecting centre point of the side road.

Where barrier lines are required for vertical or horizontal alignment, sight restrictions take precedence over standard rural two-lane, two-way road intersection treatments.

2.1.18.2 Property accesses

Gaps should not generally be provided in double two-way barrier lines. Leaving a gap allows a driver to legally enter and leave the road as well as U-turns at a place where there may be restricted sight distance due to horizontal or vertical curves. A gap may only be provided where a survey determines that sufficient sight distance is available to safely allow all movements.

Where provided the gap shall generally be 5 m. The gap may be increased at wider accesses or where the turning vehicle envelope would otherwise cross the double two-way barrier lines.

2.1.19 LONGITUDINAL LINE STYLE TRANSITIONS

2.1.19.1 Dividing lines

Broken (standard) to enhanced broken

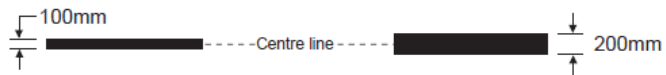

Unbroken to enhanced unbroken

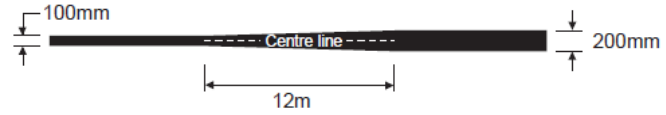

Enhanced unbroken to standard outline

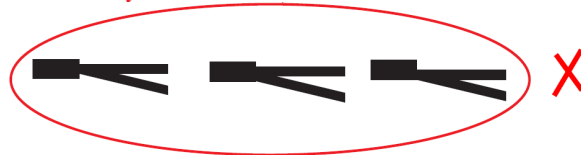

2.1.19.2 Barrier lines

Transition from 'one direction' to 'both directions' lines

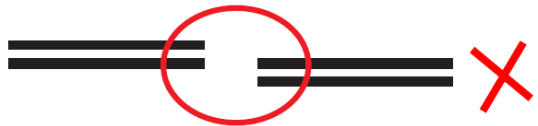

2.1.19.3 Edge lines or outlines

Transition between normal and enhanced.

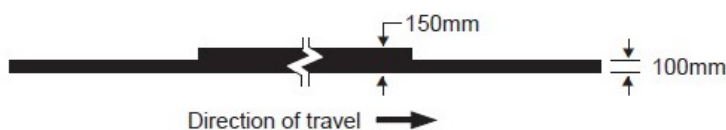

LONGITUDINAL LINE STYLES TRANSITIONS (continued)

2.1.19.4 Edge line mis-match

A mis-match of the edge line road markings may result where a change of lane width occurs after sealing the road shoulders, resealing works or road reconstruction. Where this occurs, a transition of the edge line between the new and existing markings shall be made as indicated in the diagrams below.

Seal width < 6.8 m (no edge line)

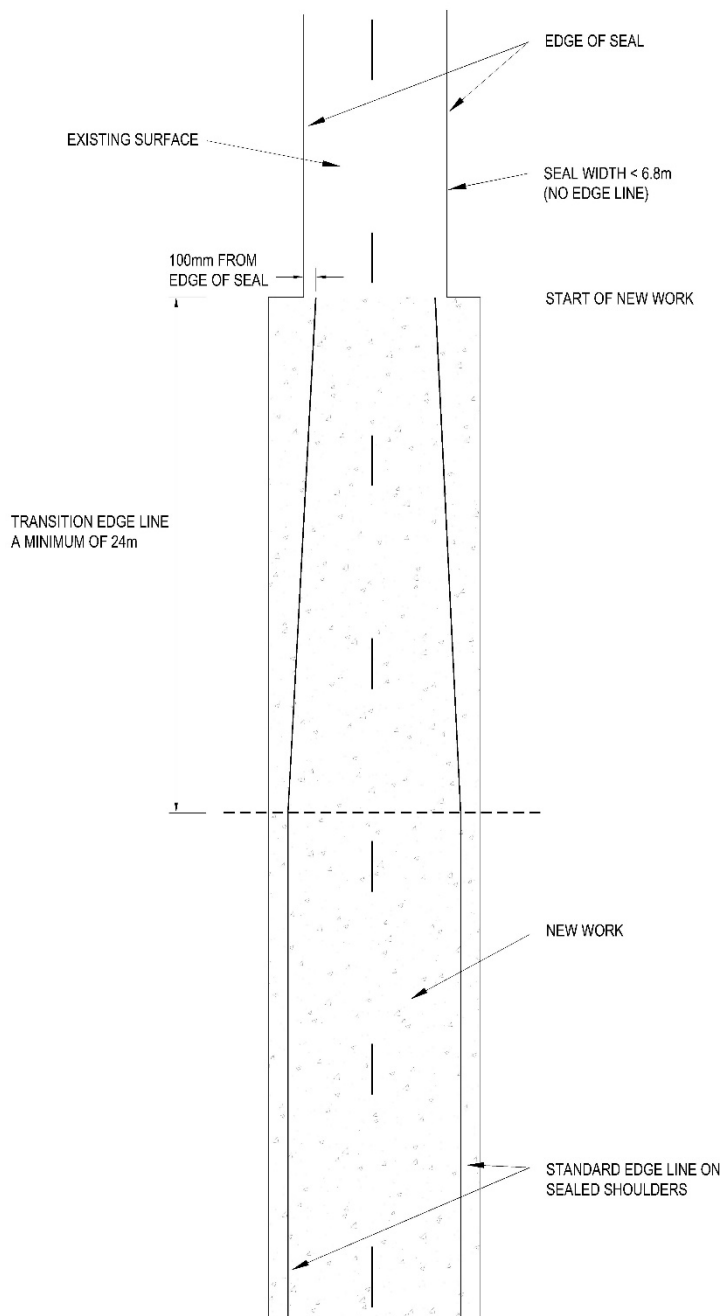

LONGITUDINAL LINE STYLES TRANSITIONS (continued)

Sealed shoulder < 0.5 m (with edge line)

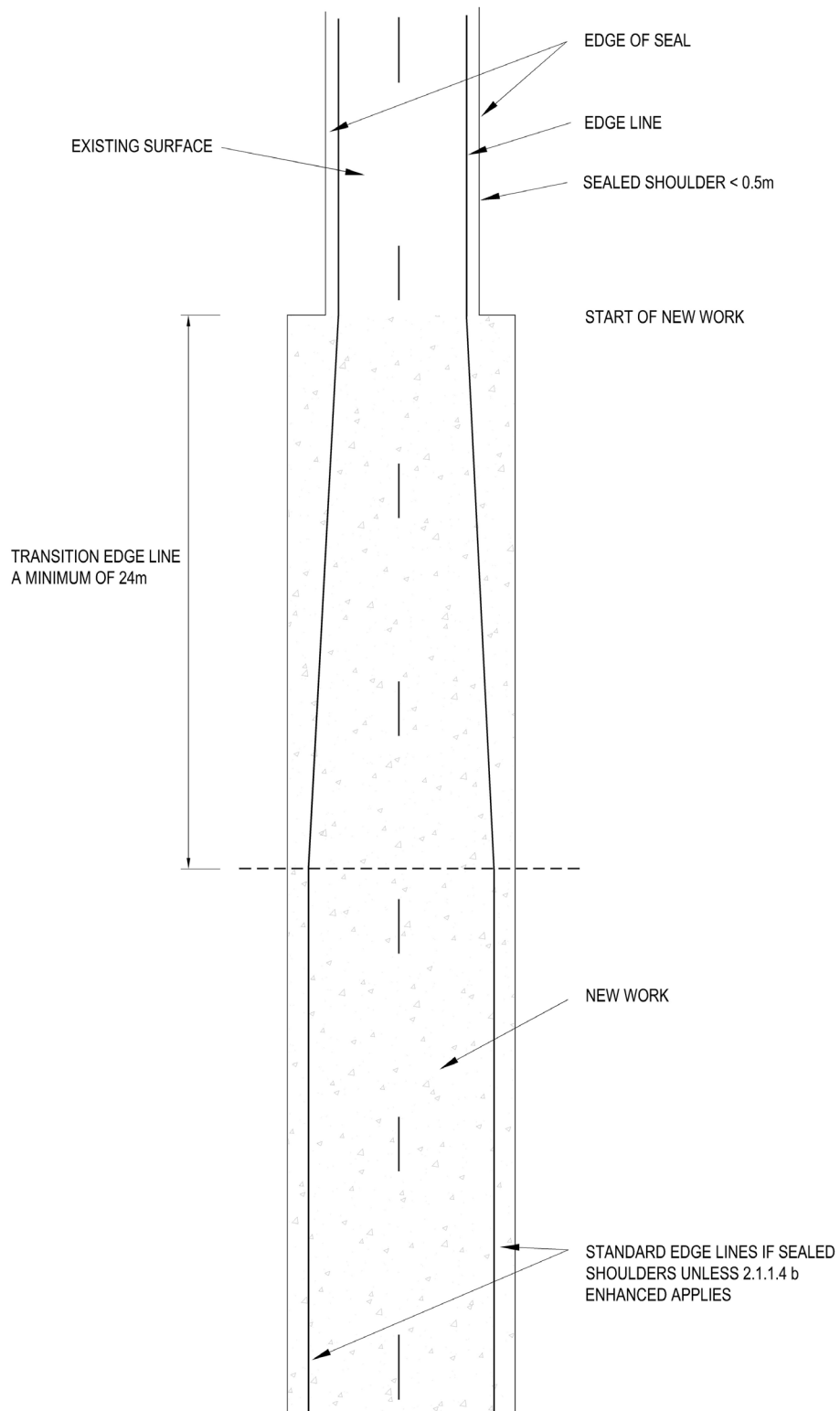

3. Design Guide

3.1 SCOPE

This section contains the requirements for the correct and consistent use of pavement markings on roads in South Australia.

It is intended that this section provides specific diagrammatic examples (i.e. not to scale or proportion) of the application of markings and where necessary, explains to the designer the reasons why certain treatments are used. It also provides references to all Standards & Guidelines.

All road authorities including their consultants and contractors are required to conform to this manual.

3.1.1 DIMENSIONING CONVENTION

All drawings are not to scale. The reader shall use the dimensions specified throughout the manual.

NOTE: Do not scale off drawings.

All markings (longitudinal and transverse) are dimensioned centre to centre, except for Give Way, Stop lines and pavement messages.

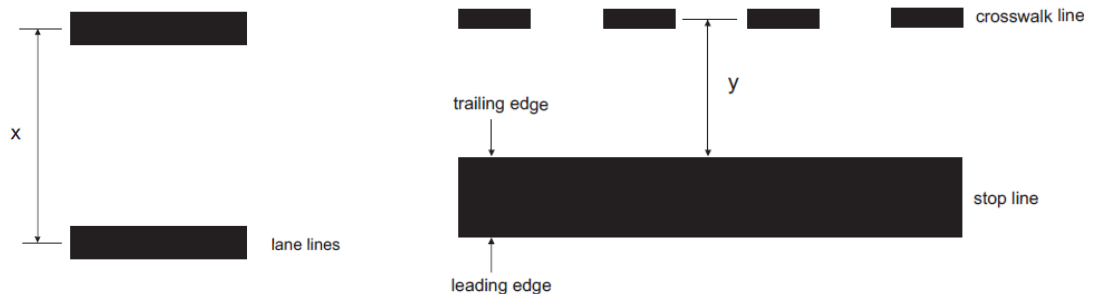

Give Way, Stop lines and pavement messages are generally measured from either the leading or trailing edge of the line or message.

3.2 TRAFFIC CONTROL DRAWINGS AND DESIGN LAYOUTS

3.2.1 LONGITUDINAL LINES

Longitudinal lines shall be shown on all traffic control drawings. This includes edge lines and outlines.

Dimensions to kerbs shall be to the kerb face. Dimensions to longitudinal lines (other than zigzag school zone markings) shall be to the centre of the line. Dimensions of barrier lines shall be to the centre of the combination of the two parallel lines.

3.2.2 TRANSVERSE LINES

Transverse lines shall be shown on all traffic control drawings. Dimensions shall be clearly shown to either the leading or trailing face of all transverse lines, except pedestrian cross walk lines. Pedestrian crosswalk lines shall be dimensioned to the centre of the line.

3.2.3 PARKING CONTROL LINES

No parking lines and signs are to be shown on Traffic Control drawings. Yellow No Stopping Line is the default, signs are used for non-compliance. **Yellow no stopping must be installed in all dedicated left turn lanes. See 3.3.14.**

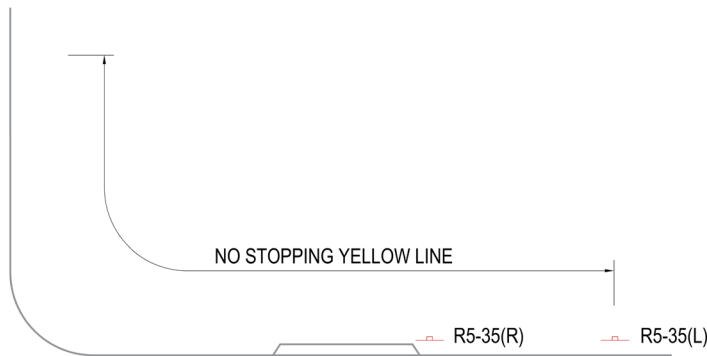

3.2.3.1 Parking Control Edge lines

Parking control edge lines shall be marked in a consistent alignment parallel to and approximately 400 mm from the kerb or edge of seal. This is to ensure that the line is not marked on the water table. Also see 3.3.14 and 3.4.9.

3.2.3.2 Parking Space Outlines

Parking space outlines shall be shown and dimensioned on traffic control drawings.

3.2.4 DIAGONAL STRIPES AND CHEVRON MARKINGS

Diagonal stripes and chevron marking shall be shown on traffic control drawings.

3.2.5 ARROWS

All arrows shall be shown on traffic control drawings and may be dimensioned longitudinally. Arrows shall be located centrally within the lane width as **shown in 2.1.7.**

3.2.6 MESSAGES AND SYMBOLS

All messages and symbols shall be shown and the longitudinal spacing dimensioned longitudinally on traffic control drawings.

Messages and symbols shall be located centrally within the lane such that a minimum of 150 mm gap is maintained between the edge of the message or symbol and the centre of any adjacent longitudinal line or to the edge of seal. Spacing between letters to form commonly used words are **shown in 2.1.8.2.**

MESSAGES AND SYMBOLS (continued)

Bicycle symbols shall be located approximately 100 mm from the bicycle lane line adjacent to the traffic lane. Where the bicycle lane is less than 1.4 metres wide it will be necessary to reduce the width of the symbol. This will be achieved by masking part of the rear wheel to preserve the 100 mm gap between the edge of the symbol and the centre of lane line. **See 2.1.8.3.**

Symbols on paths shall be located centrally within the designated area of travel i.e. between the left edge of the path and the separation line. Examples for both symbols and messages on paths is **shown in 3.3.23.**

3.3 URBAN (Built-up area) TREATMENTS

References: ARR Rules 132, 134, 208 (6); AS 1742.2 Section 5; GTM Part 10; OI 2.15; OI 2.27

General treatments are considered those that apply to all Access, Connector, Arterial, and Motorway type roads in built up areas, in or near cities and townships. They may include roads of any speed environment.

3.3.1 DIVIDING LINES

There is no traffic volume warrant for the provision of dividing lines on urban roads in South Australia.

Any assessment for the need for dividing lines should take the following into consideration:

- All 'arterial' roads shall be provided with dividing lines in urban areas, and shall be augmented with RRPMs.
- All 'collector' roads should be provided with dividing lines.
- Local roads may be provided with dividing lines. Installing dividing lines on narrow roads may have implications for parking.
- Where provided between major intersections, dividing lines should be broken and shall be standard width for two lane roads and enhanced for multi-lane roads. Note that turning lanes are considered as a lane in a multi lane configuration.
- Where provided on minor or local roads at intersections, short sections of unbroken barrier lines may be provided. **See** intersection examples in **2.1.5.1, 2.1.15.8, 2.1.15.9 and 3.3.17.**
- Double barrier lines, i.e. double one-way barrier or double two-way barrier are not used on urban roads.
- Broken dividing lines on arterial roads continue through minor road intersections.
- On any road, a gap is provided in continuous unbroken barrier lines through intersections. **See 2.1.5** for examples.

Parking is also prohibited if the parked vehicle is less than 3 metres from the barrier line (continuous dividing line) as specified in *ARR Rule 208 (6)*.

Dividing lines are not normally necessary on minor road approaches to major roads. However there may be situations where such lines could provide additional guidance to road users. Such cases include:

- Wide side roads.

DIVIDING LINES (continued)

- Multi lane side roads.
- High volumes of right turn movements into and/or from minor road.

Dividing lines should not be provided on minor road approaches where right turn and through movements are prevented or prohibited from the minor road.

Dividing lines should always be provided on minor road approaches that have give-way or stop lines. **See 3.3.17.**

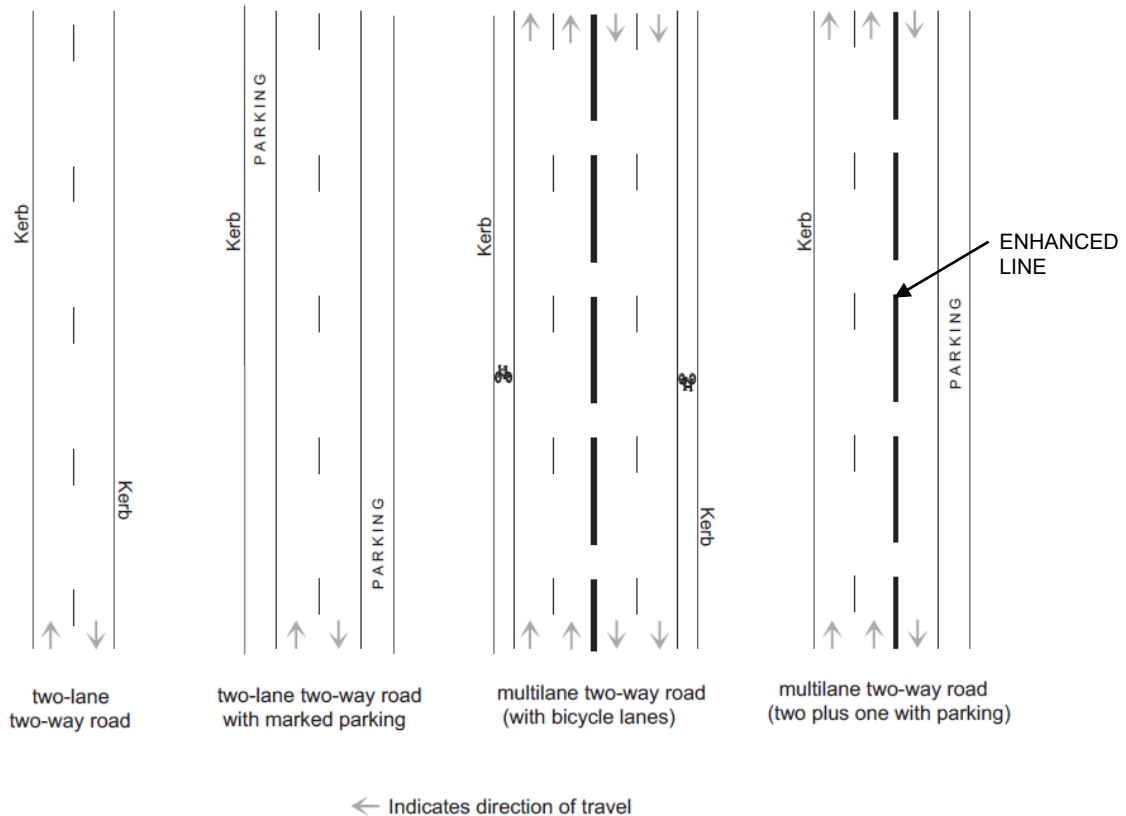

3.3.2 BARRIER LINES

Double one-way barrier lines are used at Railway Crossings and Ferries in both rural and urban areas where the speed limit is ≥ 80 km/h to prohibit overtaking on the approached side. A single unbroken barrier line should be used where the speed limit is ≤ 70 km/h or as an alternative to permit traffic to cross the line to enter or leave the road. Where single unbroken barrier line is used, it shall be standard width on roads ≤ 70 km/h and enhanced on roads ≥ 80 km/h. Note that unbroken barrier continuous lines are still subject to the requirements of AS 1742.2 Clause 5.3.

Generally single unbroken barrier lines should be used instead of double barrier lines (one-way or two-way) in urban and low speed rural areas.

It is important for designers to remember that the use of single unbroken barrier line prohibits certain crossing movements, including U-turns, but does not prohibit entering or leaving the road. U-turns should generally not be restricted by the use of single unbroken barrier lines unless sight distance is poor or special facilities have been provided to satisfy U turn demand within the section of road. If used, consideration should be given to allow for U-turns movements at safe locations.

BARRIER LINES (continued)

There is a temptation to use double barrier lines (double one-way or double two-way) to control vehicle movements. However, experience has shown that such treatments are generally too passive in nature. Where it is considered necessary to prohibit all crossing movements (for road safety) then preference should be given to physical controls e.g., raised medians and islands, that are self-regulating and do not rely on police enforcement to be effective.

For information on the use of barrier lines on rural roads, **see 3.4.4.**

3.3.3 DIAGONAL STRIPES AND CHEVRON MARKINGS

References: ARR Rules 88, 138 and 197; AS 1742.2 Section 5; GRD Part 4A

Diagonal stripes and chevron markings are used to augment and highlight pavement marking treatments. They often have legal significance under the ARR. They take the form of chevrons when used to indicate that drivers, travelling in the same direction may pass either side of the treated area or as diagonal stripes where the treatments separate opposing traffic flows. **See 2.1.6** for detailed layout of stripes.

Diagonal stripes or chevrons **shall** be installed in painted (median) islands.

Spacing between diagonal stripes at low-speed turns is generally 6 m. The spacing for diagonal stripes and chevron markings is generally 6 m on roads 70 km/h or less, 12 m on roads 80 km/h or greater and 24 m or 48 m on freeways/expressways.

Diagonal stripes shall be nominally 45 degrees to the direction of travel whether straight or curved and shall be nominally 45 degrees to the centre line of the divergence where drivers travel on both sides of the markings. While not exclusive, below are examples of diagonal treatments.

Traffic on either side (opposing direction)



Traffic to right side only



Traffic on either side (same direction)

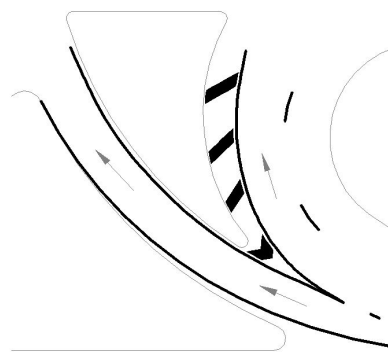
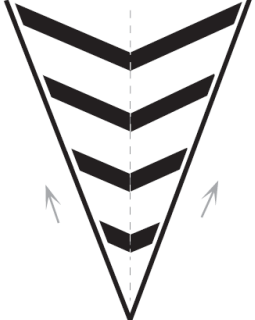

← Indicates direction of travel

DIAGONAL STRIPES AND CHEVRON MARKINGS (continued)

3.3.3.1 Wide Pavement Areas

Where a single travel lane is greater than 4 m at an intersection, or the expanse of the sealed intersection is that large, stripes / chevron markings should be used to provide lane discipline for the smaller turning vehicle.

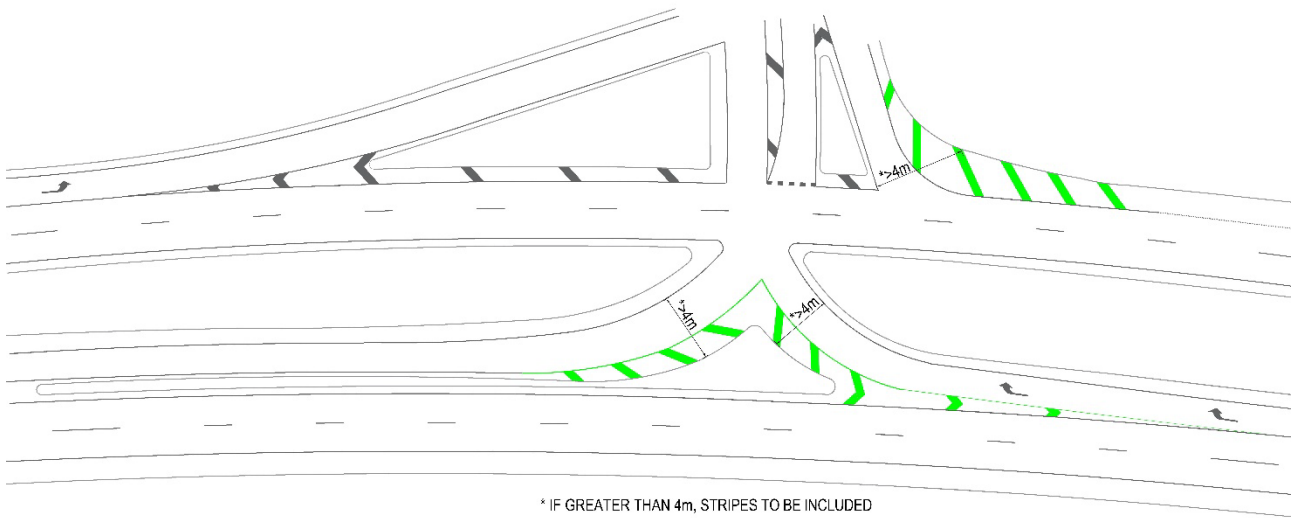

3.3.4 PAINTED ISLANDS

Painted islands may separate lanes dividing opposing traffic streams, while allowing access to and from the road or entrance to a turning lane. Refer ARR Rules 138 and 137

They are also used for cyclist separation on high-speed roads. Refer AS 1742.2 Clause 5.6.

It should be noted that unlike raised medians, painted islands do not provide physical control of traffic movements, nor do they have the advantages of being clearly visible, especially at night and in wet weather.

Spacing between diagonal markings (stripes)

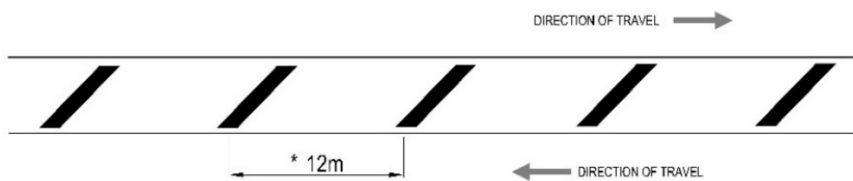

Diagonal marking variations for painted islands

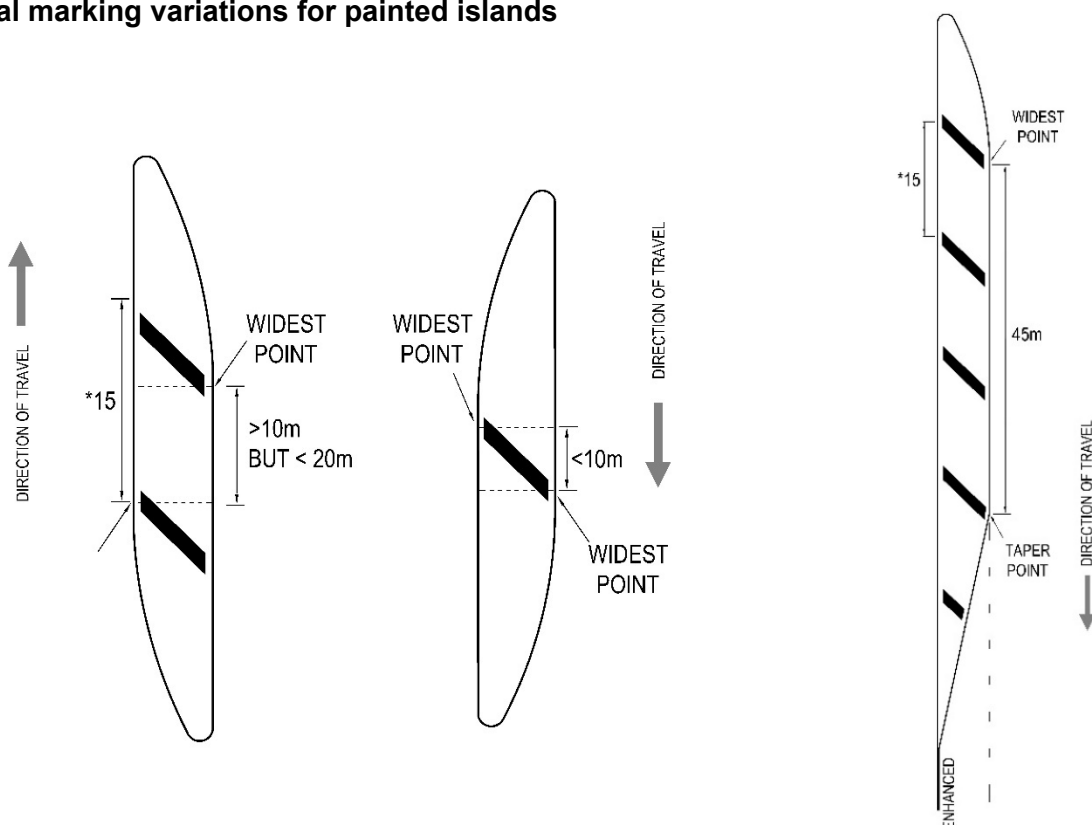

* Generally spacing between diagonal markings should be 12 m for speeds < 80 km/h. Spacing may be varied between 10 – 15 m to suit island lengths. 24 m spacing should be used for speeds 80 km/h or greater and spacing may be varied between 20 – 25 m. Spacing must be consistent along entire length of each median section. Although it is preferable to provide at least 2 diagonal markings in short lengths, one marking may be used in cases of very short lengths.

PAINTED ISLANDS (continued)

3.3.4.1 Bicycle lane safety strip

References: *Cycling aspects of Austroads Guides; AS 1742.9*

Stripes are required adjacent parallel parking where safety strip < 0.5 m.

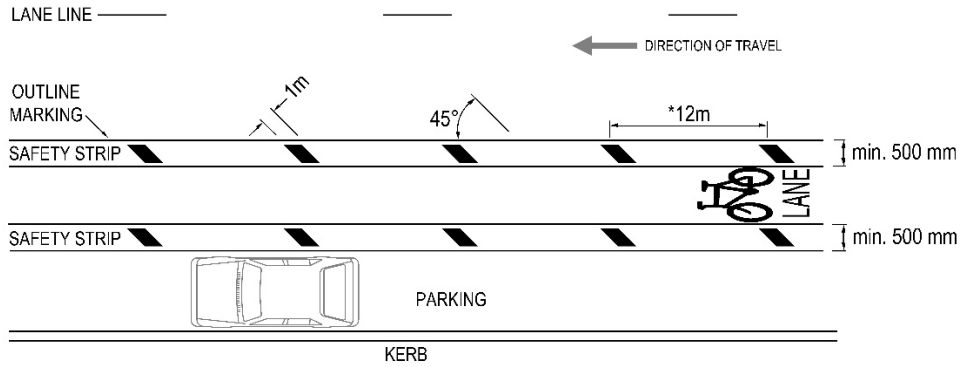

NOTE: SAFETY STRIPS MAY ALSO ONLY BE ONE STRIP ON EITHER SIDE.

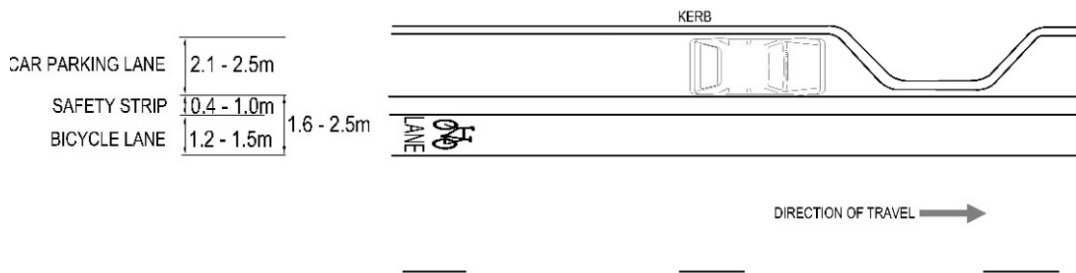

Stripes not required adjacent angle parking.

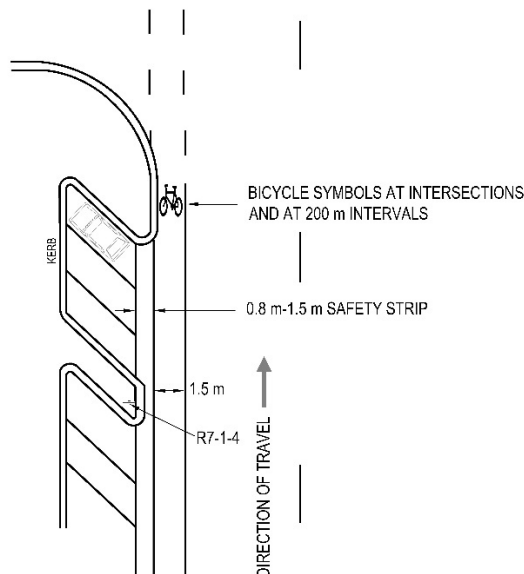

3.3.5 CORNER ISLANDS

The use of very small corner islands (less than 3 m sides) should be avoided. Such islands cause confusion to drivers regarding give way responsibilities when turning at intersections.

Chevrons and diagonal stripes may be used between the outline and the kerb of a raised island where better turning control is required. However, they should only be augmented with diagonal stripes where the distance between the kerb and outline is greater than 1.0 m.

3.3.5.1 Painted Island

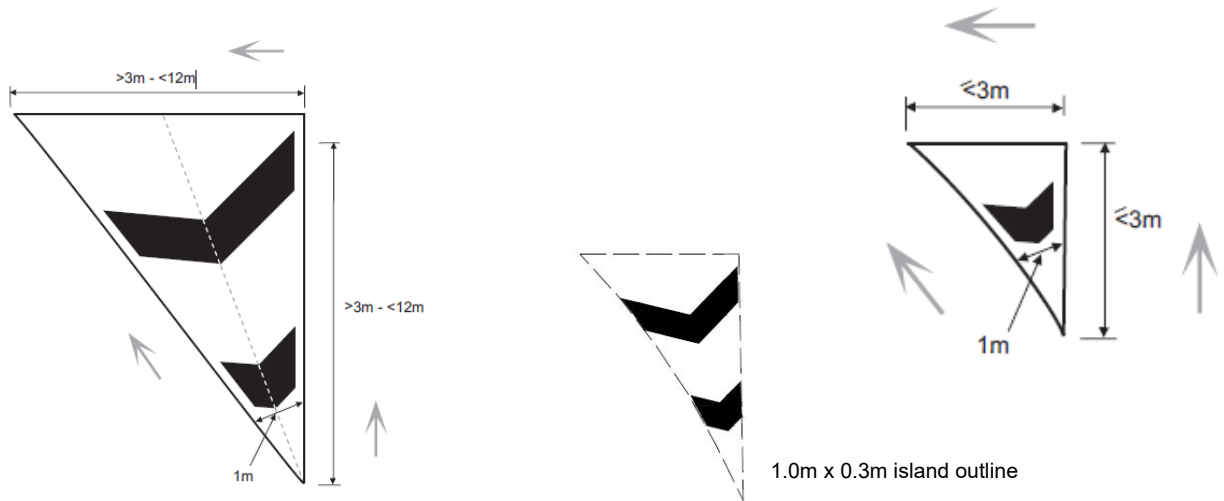

Corner Islands both flush and raised for left turning vehicles should be augmented with chevron markings for the guidance of both left turn and through vehicles. The treatment also clearly defines the differences in the ARR between turning movement priorities at intersections.

References: ARR Rules 62, 69 (2A) and 72 (4), 138 (3)(b)

NOTE: A broken edge around a painted flush island is used to allow heavy vehicles to legally cross over when turning paths are restricted.

3.3.5.2 Raised Corner Island

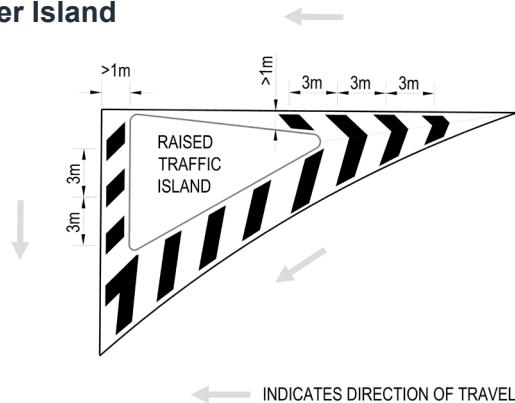

CORNER ISLANDS (continued)**3.3.6 CORNER TREATMENT**

On curved alignments, where diagonal markings are not parallel, the spacing of the markings shall be measured at the outline or edge line.

Reference: ARR 138 (2)(a)

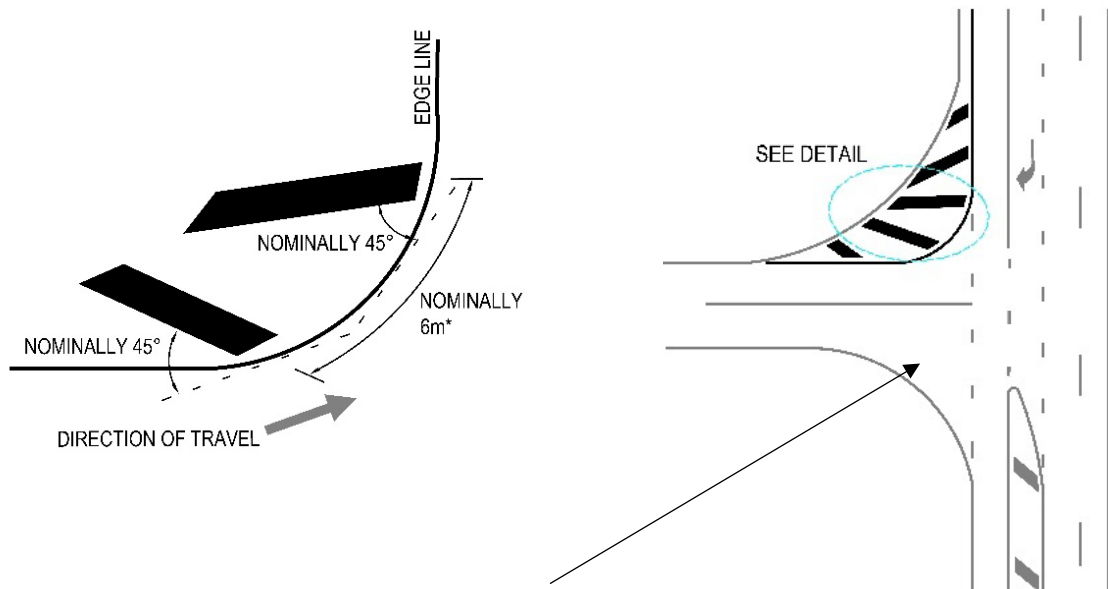

NOTE:

MAY BE REQUIRED TO REDUCE APRON WIDTH

The use of diagonal stripes is discouraged on left turn treatments, where the left turn driver has priority i.e., AUL type treatment, **see 2.1.15.9**.

Stripes are a passive treatment and at left turn locations are driven over regularly, requiring additional maintenance. They can also be a slip hazard with differential skid resistance between the painted area and the pavement.

However, where wide aprons are provided to cater for heavy vehicle turn paths, diagonal stripes on left turn treatments may be provided to reduce the apron width and provide a clearer travel path for left turn drivers.

NOTE: Nominal spacing between stripes is 6 m and nominally 45 degrees to the tangent along the edge line but may be varied. For rural treatments the spacing may be increased depending on the radius of the curve. Where the section to be striped is short it is preferable to provide stripes closer together (as close as 3 m) to ensure the stripes provide the desired effect.

3.3.7 HIGH ANGLE TREATMENT

Diagonal stripes adjacent to kerbs at left turn treatments may be placed to guide standard design vehicles through left turns. Vehicles such as semi-trailers are permitted to turn over diagonal stripes to complete turns. Diagonal markings may be supplemented with pavement bars to promote lane compliance.

Reference: ARR Rule 138 (2)(a)

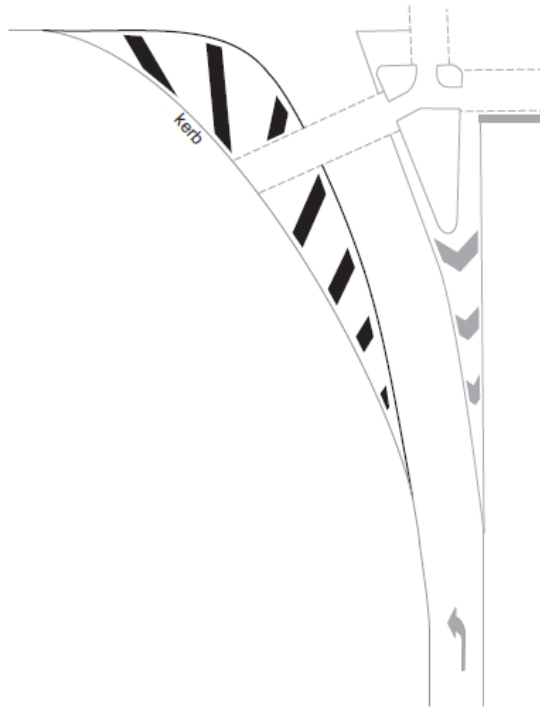

Special purpose lanes and corner island treatments, adjacent to vehicle through lanes.

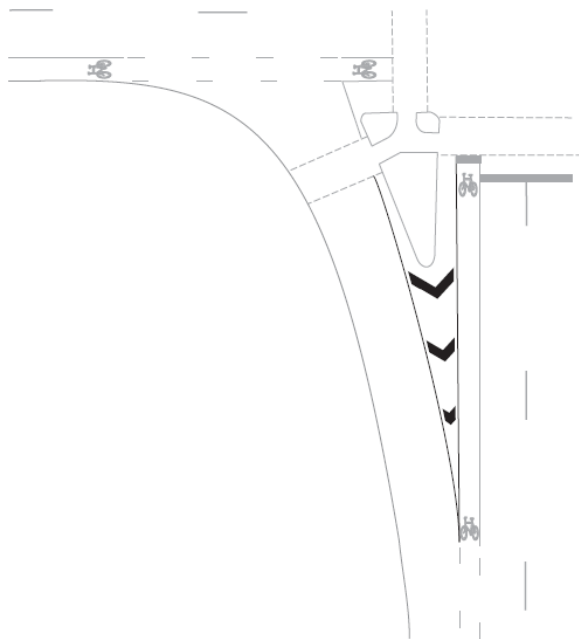

3.3.8 DIVERGE AND MERGE TAPER TREATMENTS

For overtaking lanes **see 3.4.8** and for diverges at kerb extensions **see 3.3.16**; the approaches to intersections e.g., CHR type treatments, refer *GRD Part 4A*.

3.3.8.1 Diverge taper treatments

It is often necessary to move traffic laterally across a section of road without merging lanes. Examples include divergence of lanes to avoid pedestrian refuges, on street parking areas and at the start of median sections.

It is preferable to provide as long a divergence length as possible, especially where two or more adjacent lanes must diverge and also if visibility to the island is reduced by vertical or horizontal alignment. Refer to GRD Part 3 for minimum length. However, experience has shown that greater lengths should be provided whenever possible. For example, extra taper length is important for pedestrian refuge situations to provide additional protection for pedestrians and to avoid damage to signs and pedestrian hand rails, **see 3.3.24.1**.

Reference: GRD Part 3 Section 9

3.3.8.2 Undivided to divided

The following example may be applied to locations where road widening has been undertaken predominantly on one side of the road.

References: ARR Rules 135, 137, 138; AS 1742.2 Section 2; GRD Part 3 Section 4.7.3, Section 9.9

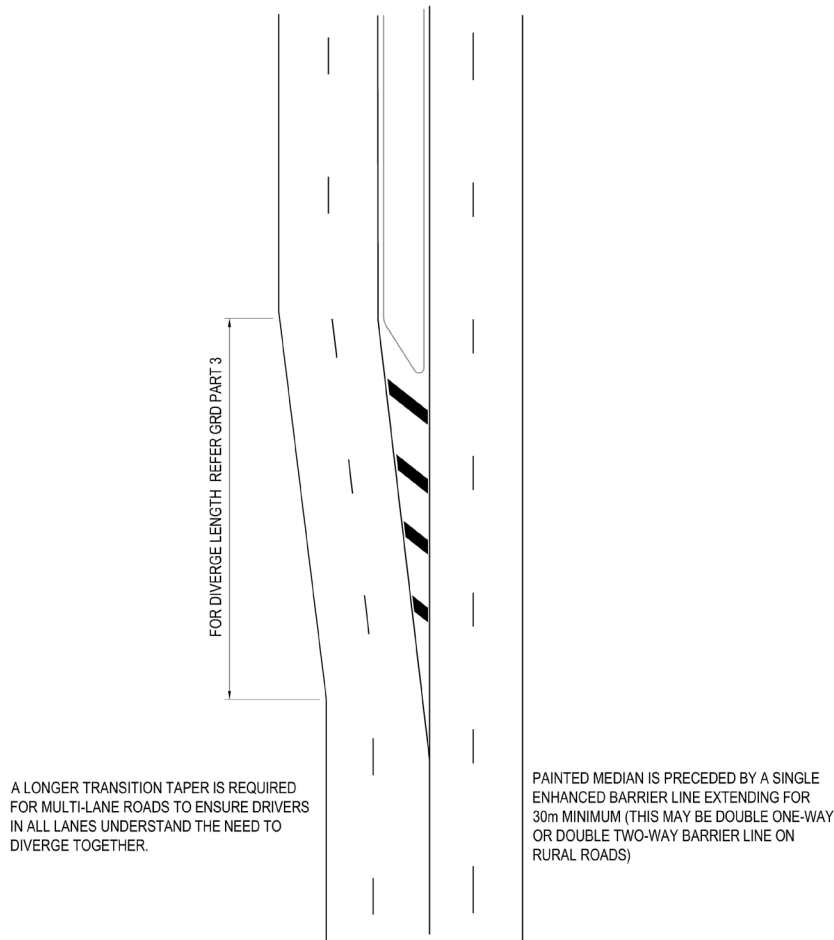

DIVERGE AND MERGE TAPER TREATMENTS (continued)

3.3.8.3 Merge taper treatments (lane drop situations)

'Zip merge', is the preferred merge treatment in **urban areas** and is only installed on roads with a speed limit of **80 km/h or less**.

References: *ARR Rule 149; AS 1742.2 Clause 4.6; GRD Part 3 Section 9.9.*

Refer to *OI 2.27* for merge treatment at end of auxiliary lane at seagull intersection.

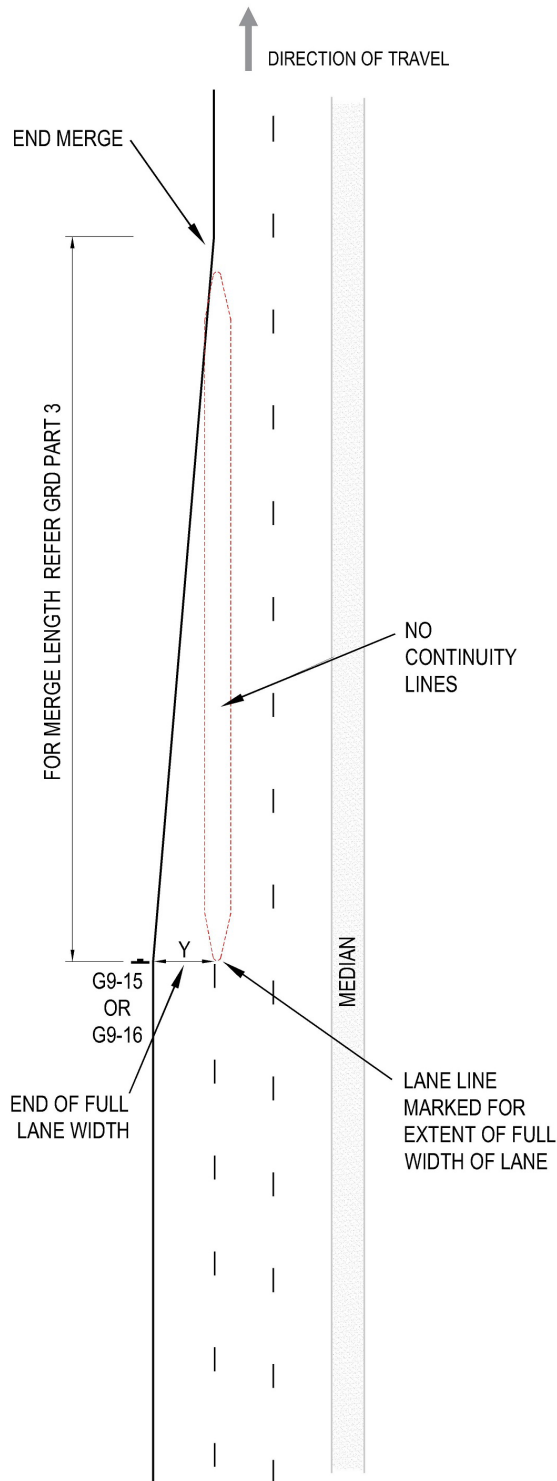

3.3.9 RAISED PAVEMENT MARKERS (RRPMs)

Reference: AS 1742.2 Clause 5.9

RRPMs used throughout the state in both rural and urban situations shall be installed on roads having a sound surface in the following conditions:

For roads under the care, control and management of CoH (DIT Roads), the following requirements apply:

- On single carriageway two-way roads or multilane undivided carriageway roads
 - RRPMs shall be used to supplement dividing lines in all situations, rural and urban
 - RRPMs shall be used to supplement edge lines in the following situations:
 - Rural roads, where the AADT exceeds 4000 vpd
 - Urban roads, where the AADT exceeds 10,000 vpd
 - RRPMs shall also be used on dividing lines and edge lines where:
 - Severe weather conditions may cause visibility issues
 - Hazardous locations, such as narrow bridges or sharp curves with a radius of less than 1500 m
 - Where warranted by an identified crash history (e.g. from ANRAM, Blackspot program, etc.)
- On divided carriageway roads:
 - RRPMs shall be used to supplement all lines in all rural and urban situations.
 - RRPMs shall be used to augment lane lines, special purpose lane lines and whenever directed by DIT.

The standard spacing is 12 m on lit and 24 m on un-lit roads.

RRPMs enhance longitudinal lines to such an extent that they discourage crossing movements. For this reason, RRPMs shall not be used on continuity lines except in circumstances shown; **see 3.3.9.1**.

RRPM may be used on Council roads (collector and local roads) where additional delineation treatment is considered necessary.

For the use of non-reflective pavement dots through intersections, **see 3.3.21.6**.

RAISED PAVEMENT MARKERS (continued)

3.3.9.1 Continuity lines

Generally, RRPMS should not be used on continuity lines. They may be required to provide guidance on long lengths of curvilinear continuity lines.

NOTE: RRPMS shall not be used on continuity lines in merging situations. Where used, spacing shall be generally the same as that applied to lane lines i.e. 12 m on lit and 24 m on un-lit roads.



WHERE RRPMS ARE USED ON CONTINUITY LINES, IT MUST BE SHOWN / INDICATED ON THE DESIGN DRAWINGS.

3.3.9.2 Bicycle lanes

Generally, RRPMS should not be installed adjacent to bike lanes, but where necessary they shall be installed on the edge line. If the traffic lane is greater than 3.0 m then the RRPMS can be installed on the right side of the edge line for the direction of travel.

NOTE: RRPMS shall not be installed inside the bicycle lane.

3.3.10 LANE LINES

References: ARR Rules 146, 147, 148; AS 1742.2 Section 5

Lane lines divide two or more lines of traffic travelling in the same direction and shall be provided on roads where traffic is expected to travel in more than one lane.

Lane lines are normally standard broken. However, unbroken lane lines may be required between exclusive through and exclusive turn lanes on approaches to intersections. **See 3.3.11.** They may also be used to restrict lane changing mid-block.

Lane lines should be continued through minor road intersections.

For lane lines on the approach to signalised intersections **see 3.3.21.5.**

For the use of **continuity lines** as lane lines (including the length of **unbroken line**) **see 3.3.11.**

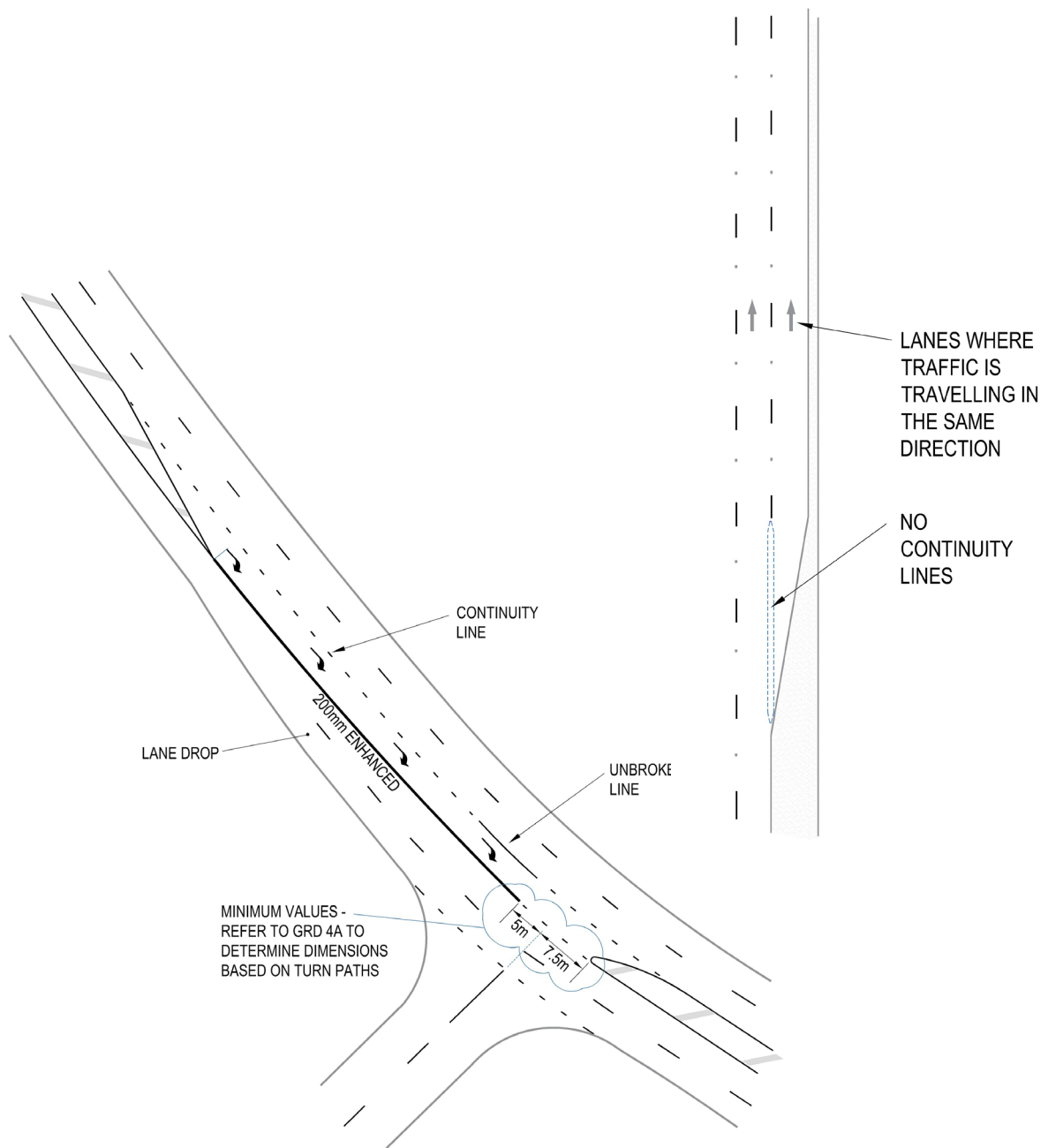

LANE LINES (continued)

3.3.10.1 Roundabouts

References: ARR Part 9; AS 1742.2 Section 5; GTM Part 6; GTM Part 10

Lane lines on the approach to a multilane roundabout are positioned as they would be for other intersections. The lane lines within the circulating lanes and leading out of a roundabout, known as special purpose lines, provide added guidance through the curves while negotiating within and exiting the roundabout. Lane lines must be curved where necessary to ensure this guidance is further enhanced.

Continuous lane line on the approach to a multilane roundabout (as shown in figure 2.8 of AS 1742.2) shall only be used where there is evidence of poor lane discipline, or the lane line separates a dedicated turning lane from a through lane. In all other cases, standard broken lane line shall be used on approach.

Exit line placement

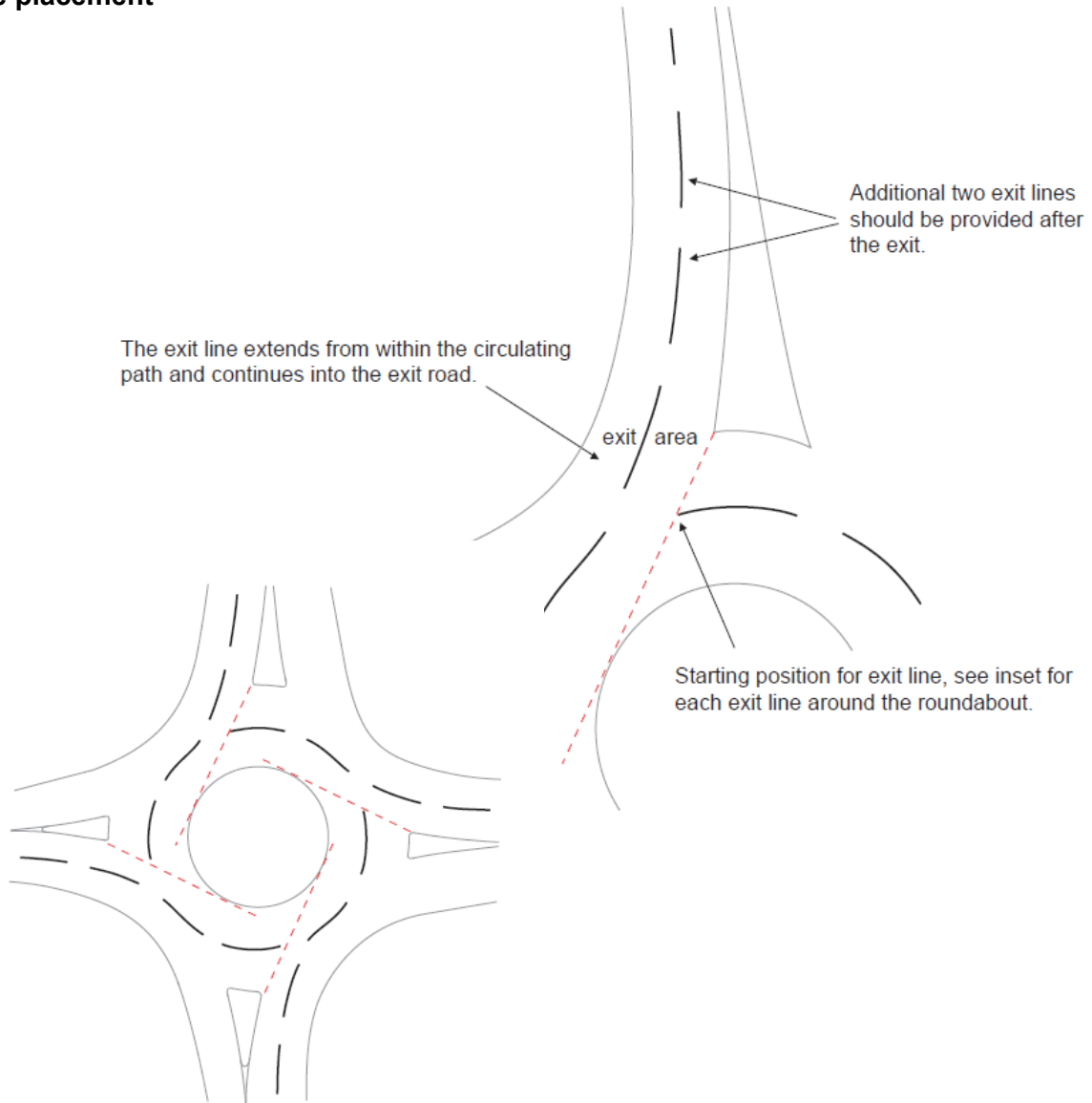

LANE LINES (continued)

Multi-lane roundabout with two single lane approaches and two single lane exits

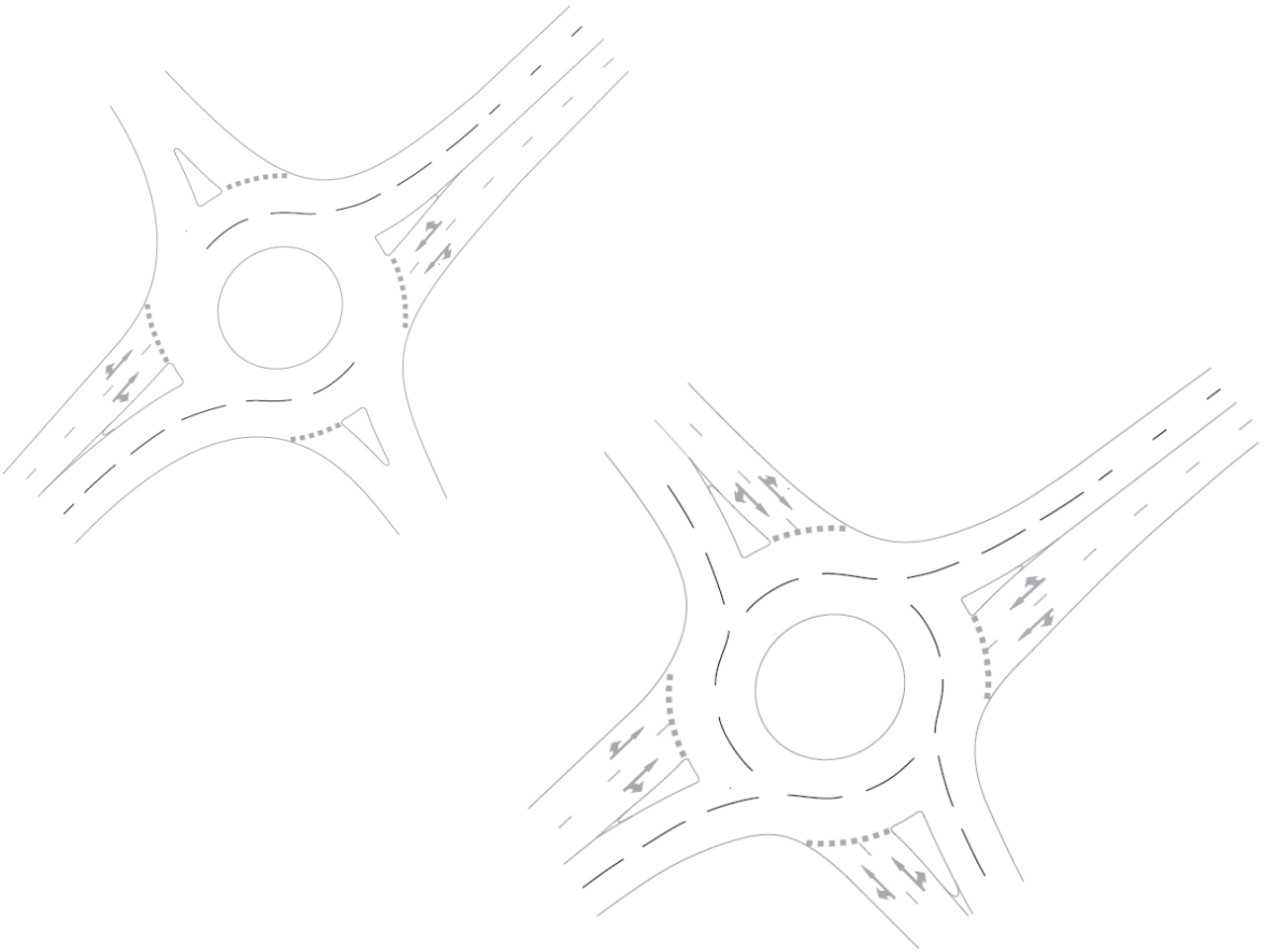

Multi-lane roundabout with two lane approaches and two lane exits

Roundabout with start-up lane within the roundabout

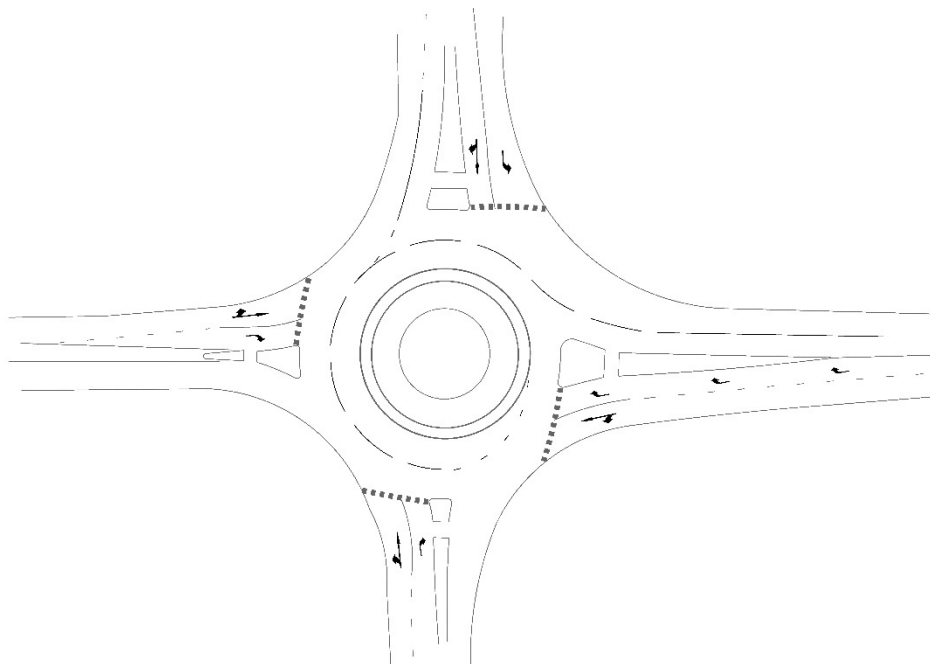

LANE LINES (continued)

Multi-lane roundabout with two approach lanes, one exit lane, and featuring an exclusive left turn lane

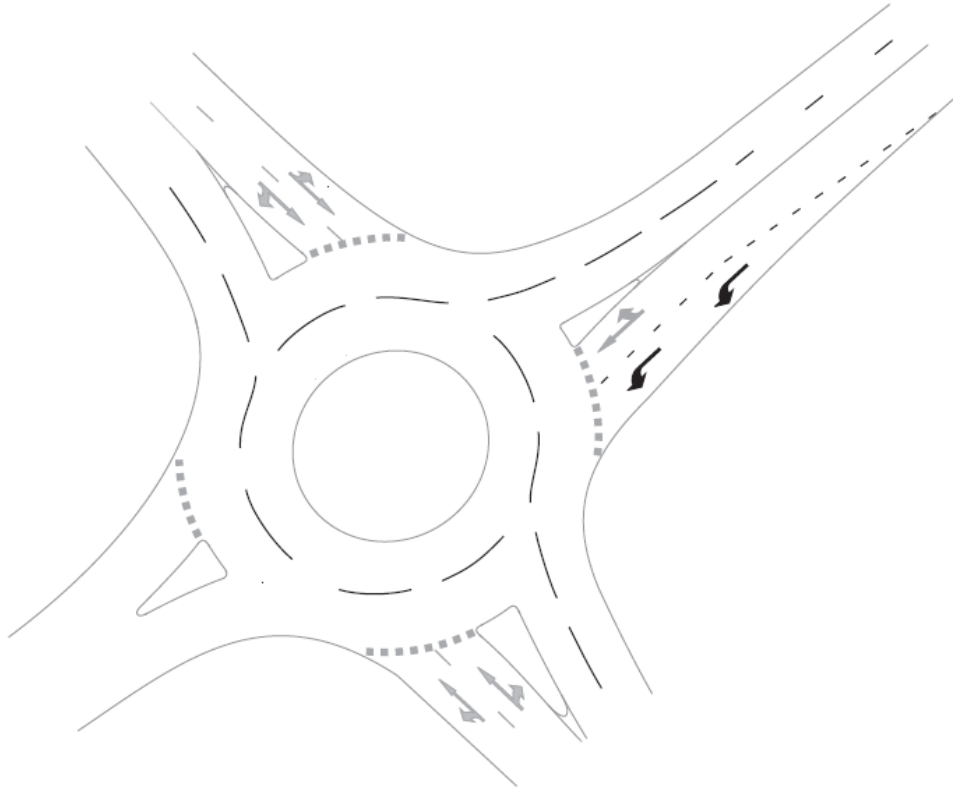

Multi-lane roundabout with two approach lanes, one exit lane, and featuring an exclusive right turn lane

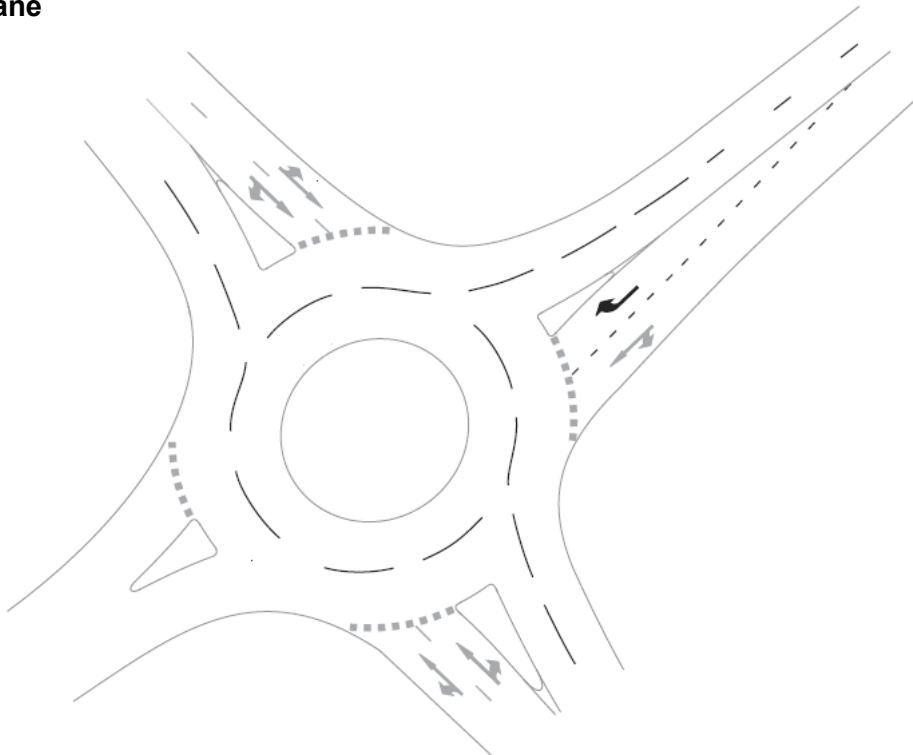

LANE LINES (continued)

3.3.10.2 Bicycle lanes adjacent to bus stops

References: ARR Rules 77, 183, 187, 195

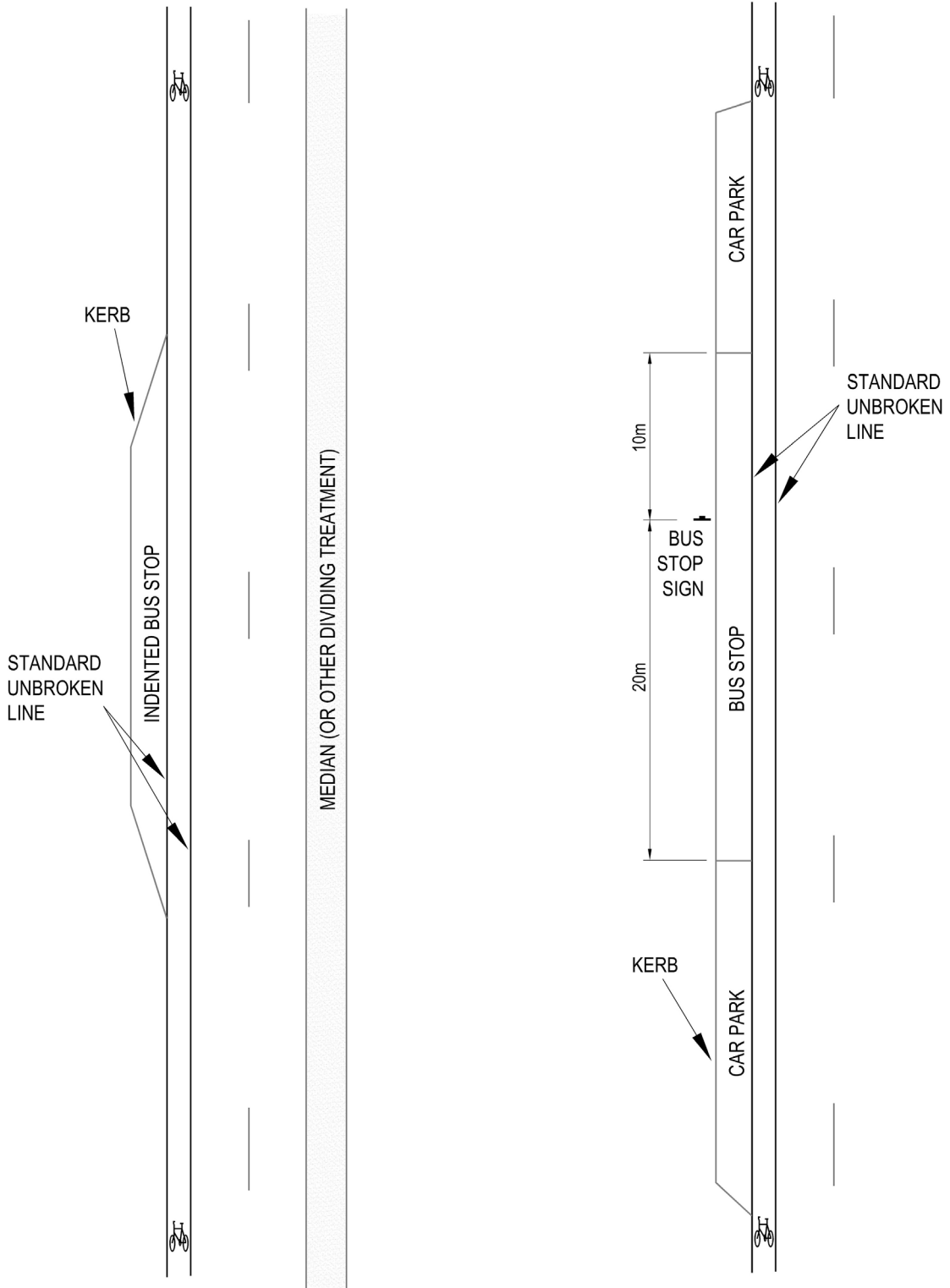

NOTE: For bus stop design requirements, refer to *GD800* <http://www.dit.sa.gov.au/standards/roads-all>

LANE LINES (continued)

3.3.10.3 Bicycle lanes start and end

References: ARR Rules 153, 187; AS 1742.9; GRD Part 3; GTM Part 10 and Part 5, Cycling Aspects of Austroads Guides; OI 9.2; OI 9.3

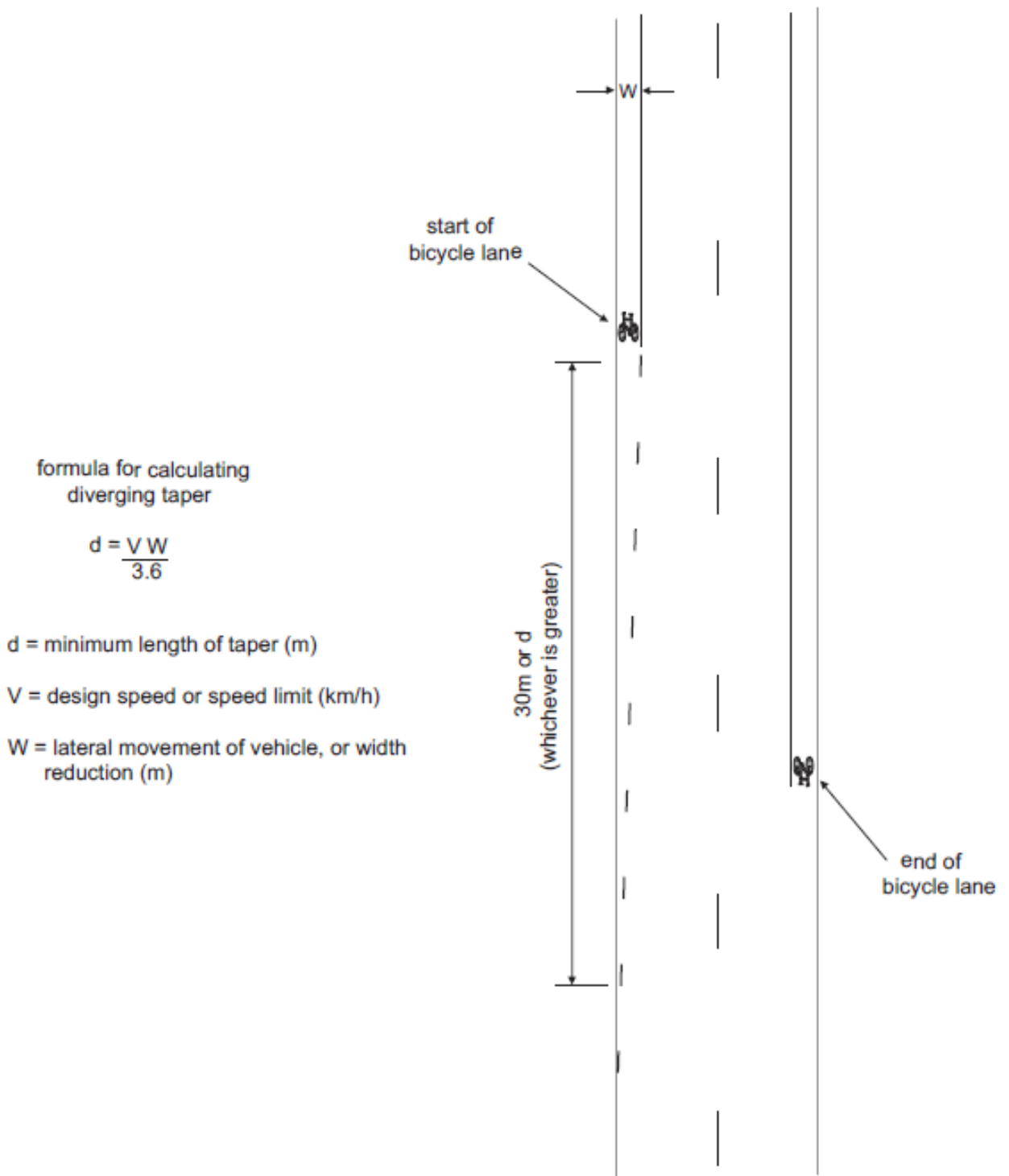

3.3.11 CONTINUITY LINES

References: ARR Rules 147, 148

Continuity lines generally provide longitudinal ‘continuity’ to traffic along lengths of road where lane lines or other longitudinal lines either cannot or should not be provided. They are used to substitute lane, dividing or edge lines where it is intended that the line be crossed by traffic turning or lane changing.

Where they are used in lieu of a lane or dividing line it is important to remember that they may continue to have the same legal effect in regard to traffic movements.

Examples of continuity lines include:

- To provide continuity at very wide straight openings across side roads or other entry and exit points along a road or across those openings that are subject to significant vertical or horizontal changes. Continuity lines should only be provided for such situations where it is likely that through traffic would otherwise lose continuity of travel. **See 3.3.11.3 and 3.3.19** for examples.
- At the start and end of auxiliary and special purpose lanes to indicate the section of road that should be crossed to access or exit the auxiliary lane.

Examples include:

- Acceleration and deceleration lanes (see below)
 - Bus lanes - **3.3.26.2 – 4**,
 - Bicycle lanes - **3.3.10.3**,
 - Overtaking lanes - **3.4.8**,
 - Slow vehicle turnouts - **3.4.9**,
 - Rest Areas - **3.4.10**.
- Across side roads and other sections of road to indicate the continuance of bicycle lanes.
- Across median openings where the median is greater than 2 m in width.

3.3.11.1 Left and right turn storage / deceleration / acceleration lanes

A	x
<72m	0m (all continuity line)
72m – 120m	12m unbroken line
120m – 180m	24m unbroken line
>180m	36m unbroken line

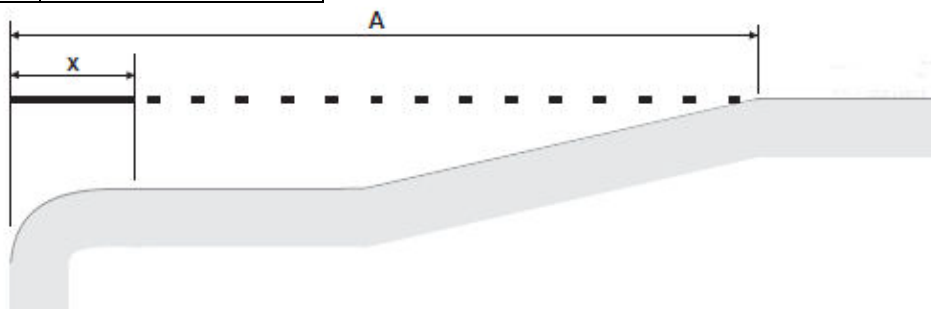

CONTINUITY LINES (continued)

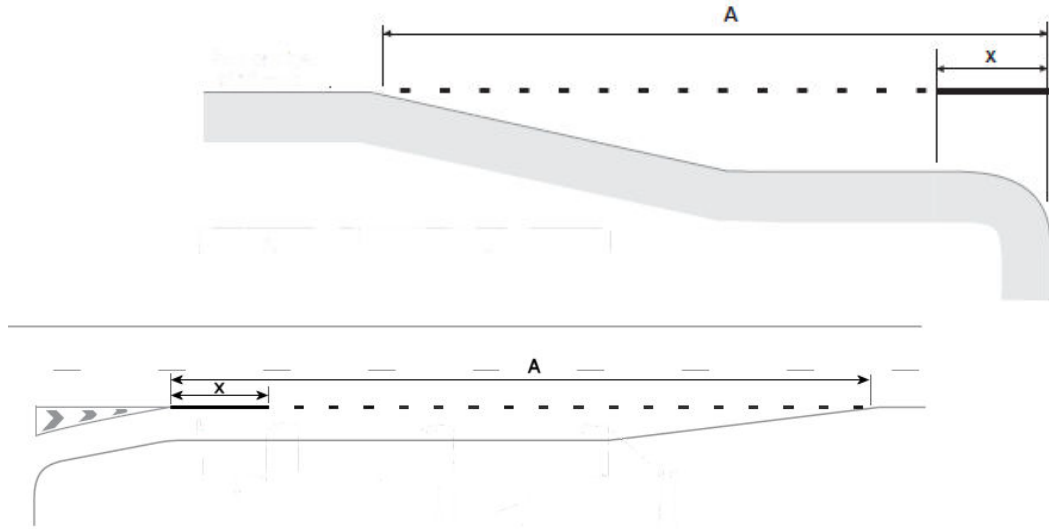

3.3.11.2 Bicycle lane continuity lines

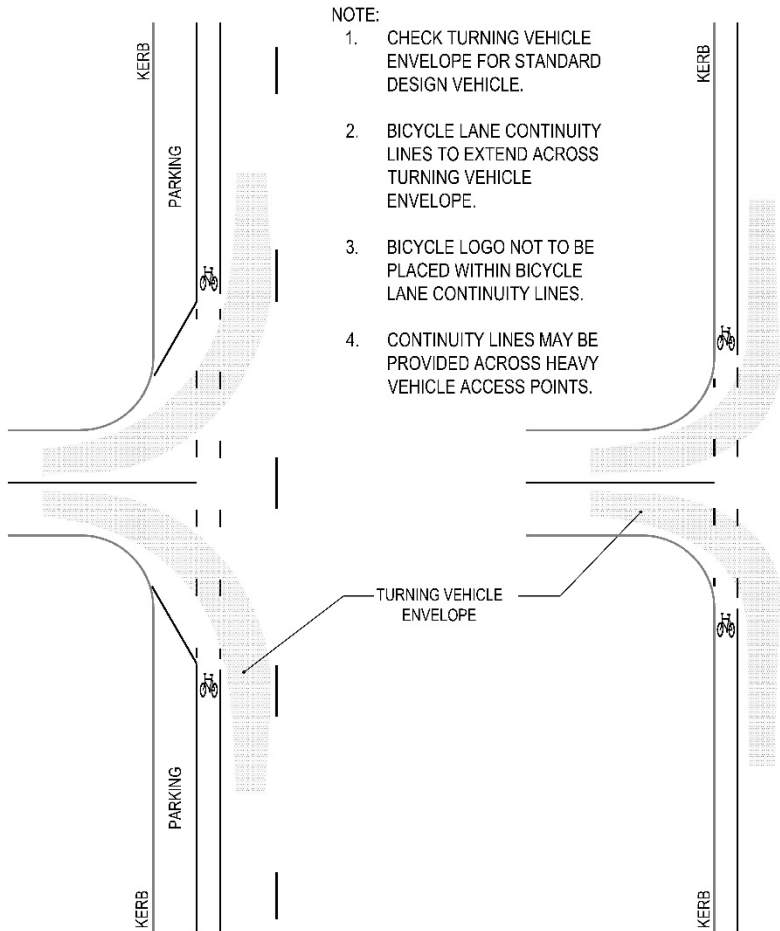

CONTINUITY LINES (continued)

3.3.11.3 Side road continuity lines

Continuity line across a side road should be provided as follows:

- Where the side road > 12 m wide (measured at the tangent points) and there is a loss of continuity of the edge line due to the road geometry (vertical or horizontal), or
- Where the distance between the TP on the main road and the dividing line of the side road is > 12 m, or
- Where a bicycle lane is provided on the main road.

If a Stop or Give Way line is required at the intersection, the continuity line shall be positioned across the right-hand side of the side road only, on the same alignment as the Stop or Give Way line. Continuity line shall only be provided across the left-hand side of the side road where the Stop or Give Way line at the intersection is set back due to sight distance or turning path requirements (for design vehicles performing a right turn into side road). Also **see 3.3.18**.

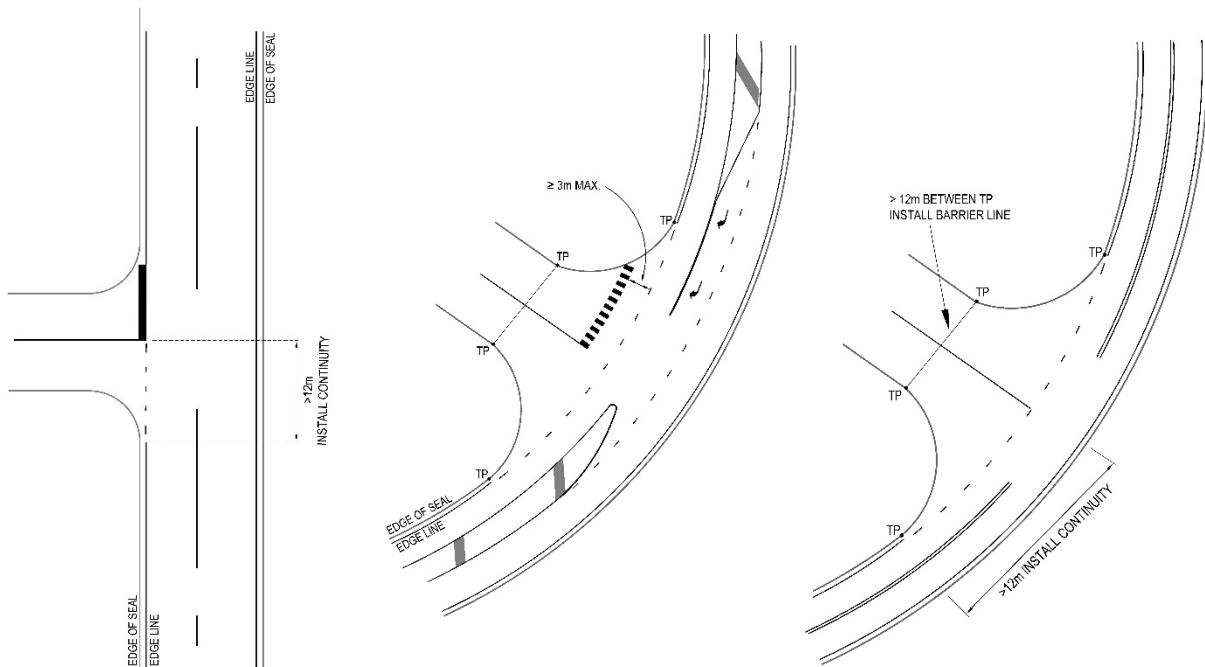

DIVIDING LINE ON THE SIDE ROAD SHOULD BE PROVIDED WHERE THE WIDTH AT TP IS > 12 m. EDGE LINE AND DIVIDING LINE TYPE ARE INDICATIVE ONLY – REFER RELEVANT SECTIONS FOR THEIR USE.

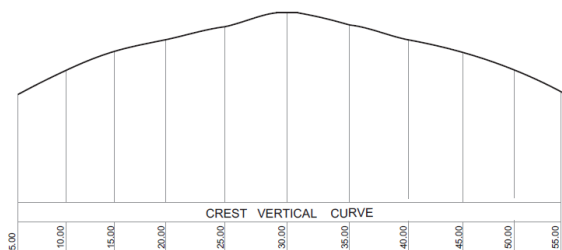

EXAMPLE OF CONTINUITY LINE THROUGH SIGNIFICANT VERTICAL CHANGE

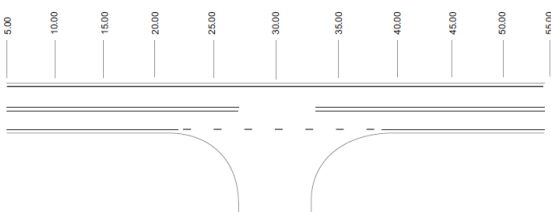

3.3.12 TURN LANES (PAVEMENT ARROWS)

3.3.12.1 Unsignalised intersections

(a) AUxiliary Left turn (AUL)

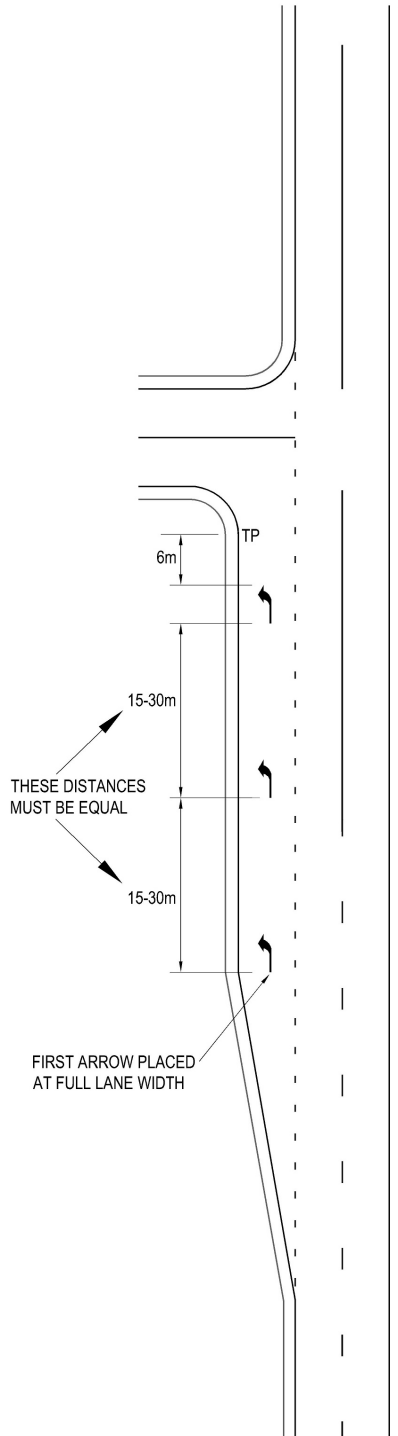

(b) CHannelised Right turn (CHR)

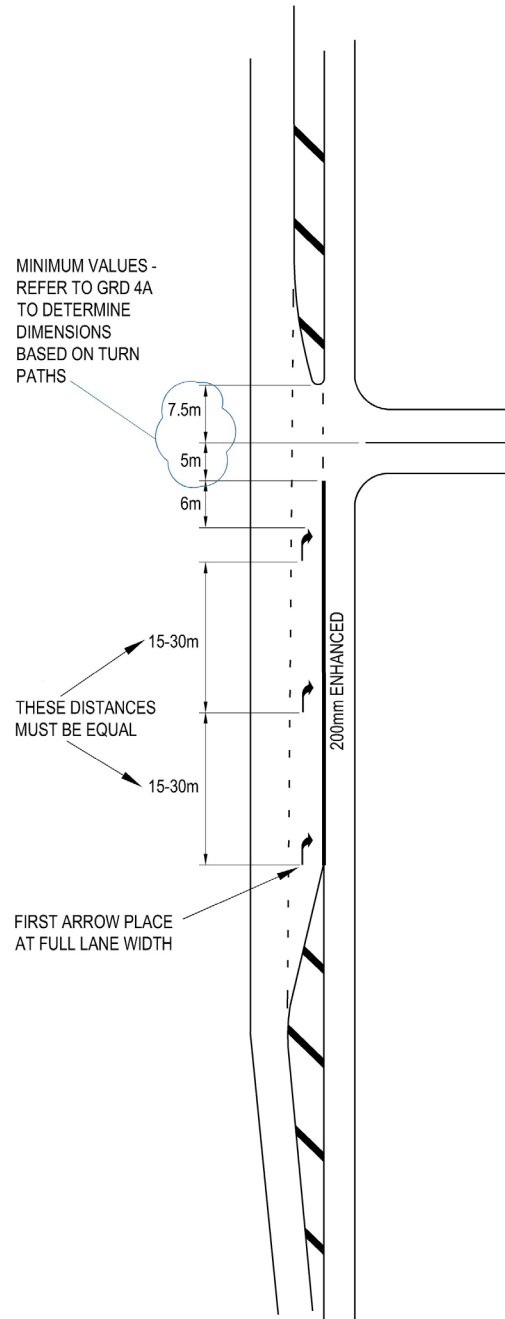

TURN LANES (PAVEMENT ARROWS) (continued)

(c) CHannelised Left turn (CHL)

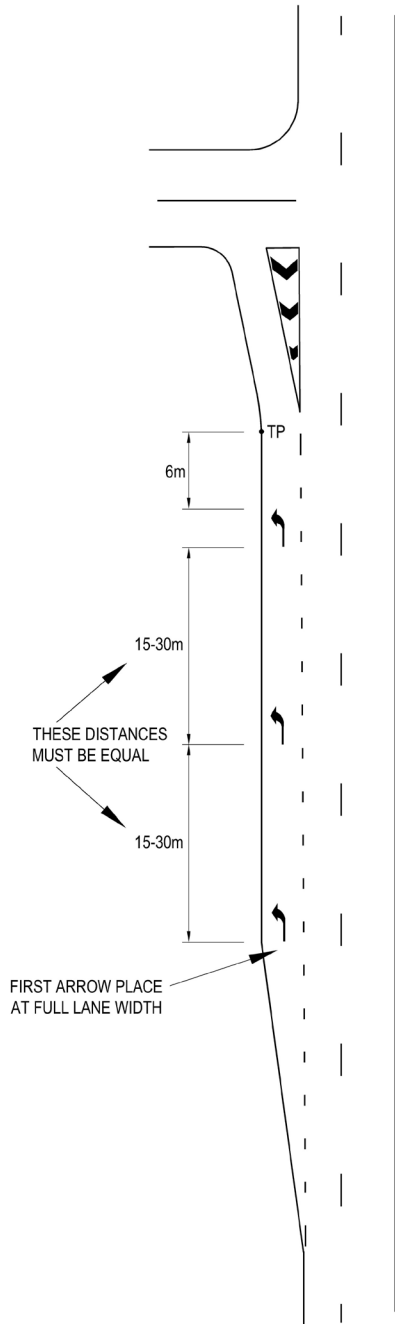

(d) Basic Right turn (BAR)
For roads ≤ 70 km/h

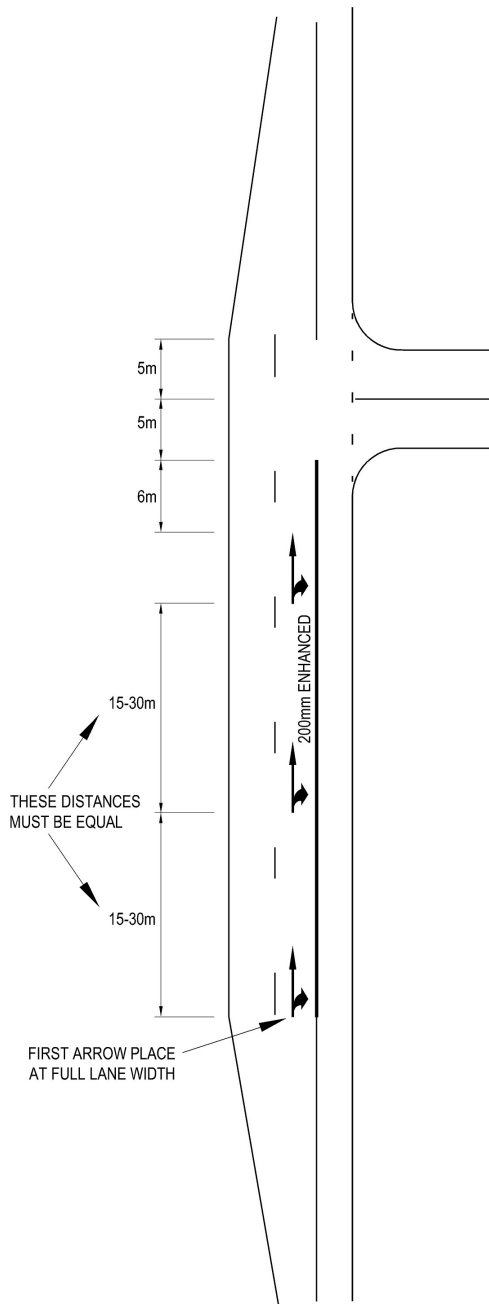

(e)

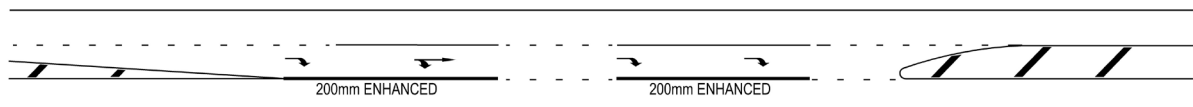

- CHR - CONSECUTIVE INTERSECTIONS - RURAL.
INCLUDE THROUGH/RIGHT ARROW AS LAST ARROW BEFORE FIRST INTERSECTION.
- THROUGH ARROW ALLOWS DRIVERS TURNING AT SECOND INTERSECTION TO UTILISE THE CHANNELISED LANE
 - THROUGH ARROW ALSO PROVIDES INDICATION TO OPPOSING DRIVERS THAT TRAFFIC MAY PROCEED THROUGH THE FIRST INTERSECTION IN THE CHANNELISED LANE

TURN LANES (PAVEMENT ARROWS) (continued)

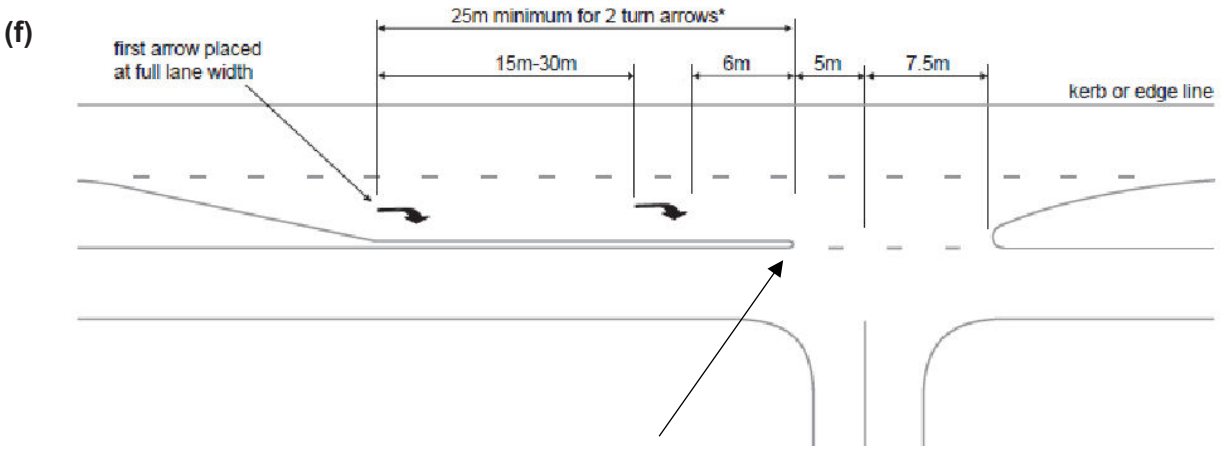

MEDIAN MAYBE CUT BACK AND REPLACED WITH AN ENHANCED UNBROKEN LINE TO ALLOW FOR CHECK VEHICLES

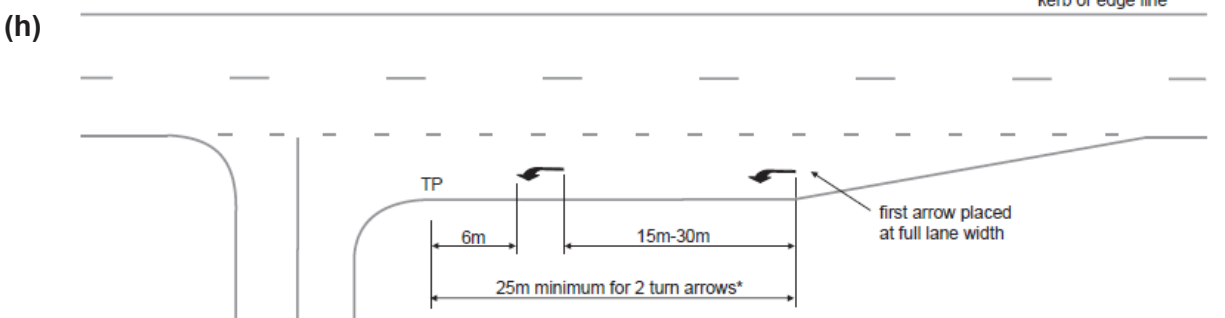
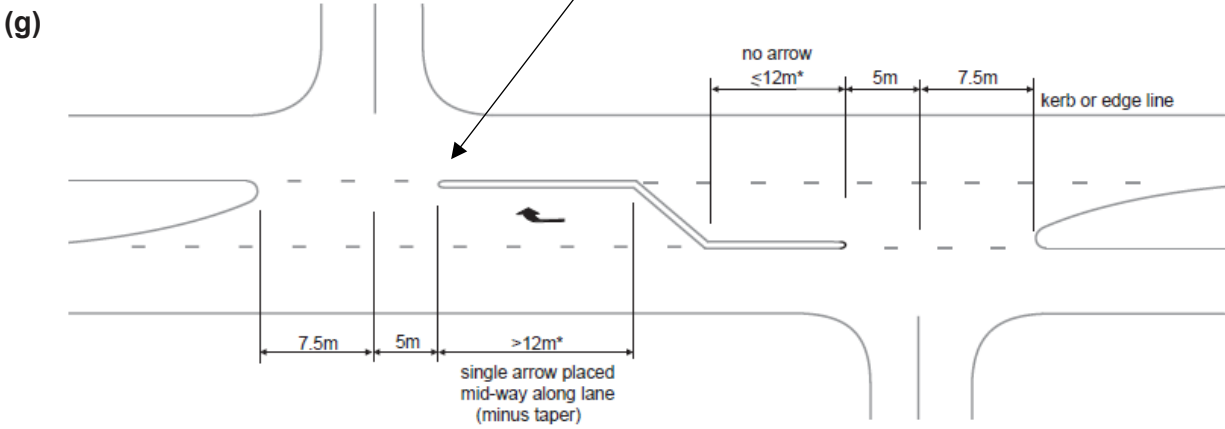

* If lane is < 25 m but > 12 m then place one arrow mid-way along lane. If lane is < 12 m then no arrows.

TURN LANES (PAVEMENT ARROWS) (continued)

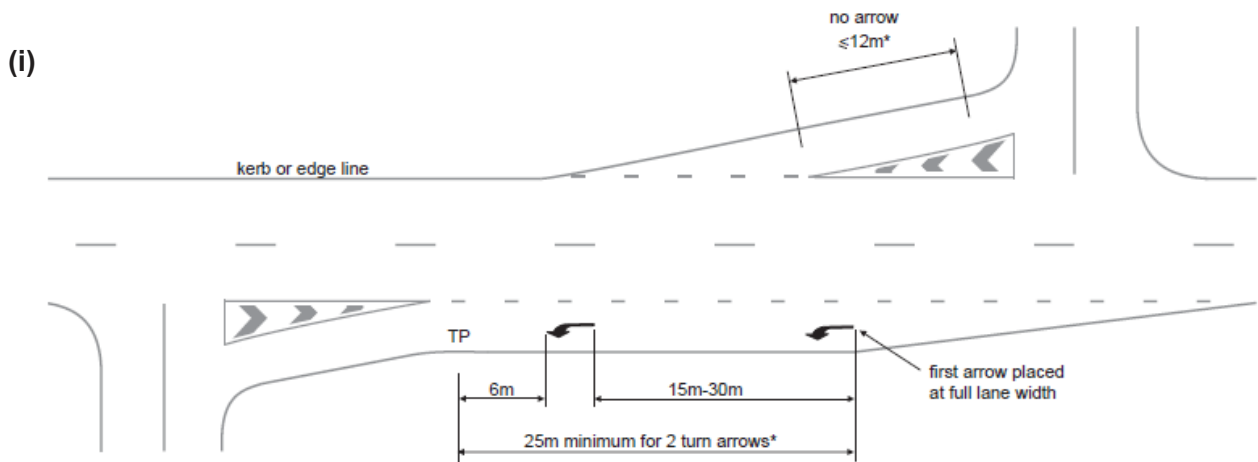

* If lane is < 25 m but > 12 m then place one arrow mid-way along lane. If lane is < 12 m then no arrows.

3.3.12.2 Median turning bays

References: ARR Rule 86, GTM Part 5 Clauses 4.4 and 6.2

For long sections of median turning lane, where multiple accesses are adjacent on both sides of the road, refer to Austroads *Guide to Traffic Management Part 5: Link Management Sections 4.4 and 6.2*.

Where staggered T-intersections occur with overlapping right turn movements in conflict, and the stagger of the intersections is less than 30 m, then the MEDIAN TURNING LANE sign (R6-30) and /or associated pavement marking may be used to designate this as a median turning bay where ARR 86 applies.

This treatment should only be used in 70 km/h or lower speed environments.

It should only be used at locations where the short stagger and volume of conflicting turning movements causes issues with the operation of the intersection. It is not required where the intersection is performing satisfactorily.

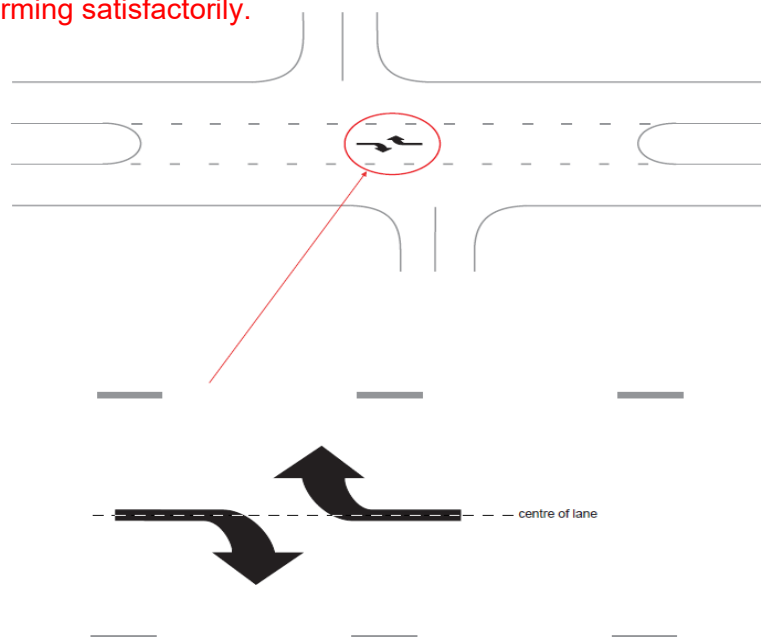

MEDIAN TURNING BAYS (continued)

Where the above criteria is not met, the following treatments for closely spaced staggered intersections may be appropriate:

- Where rat-running between side streets occurs, a solid diagonal back-back median may be installed as per the figure below. A continuous diagonal line should not be used.

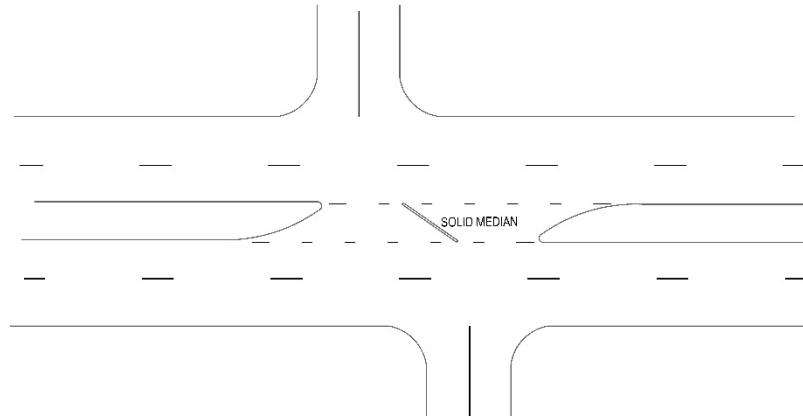

- Where the stagger is greater than 30 m, shortened back-back turn bays should be installed, with a minimum taper of 10 m between the storage areas.

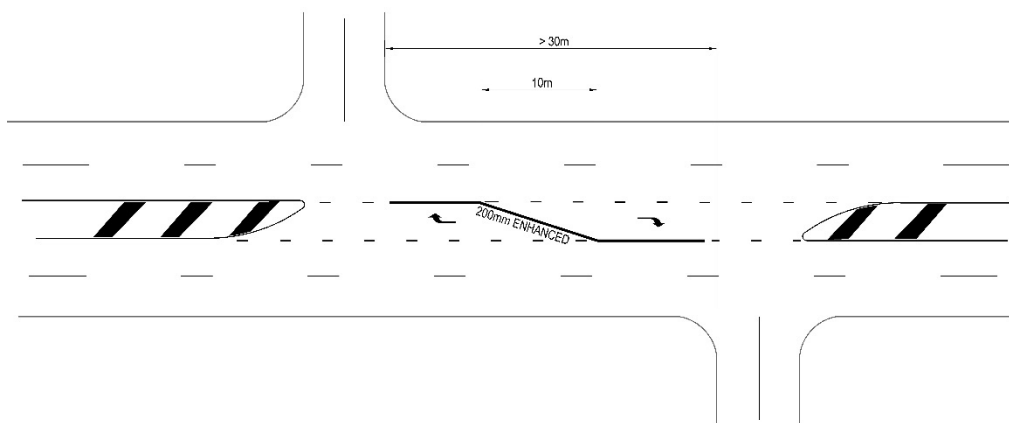

3.3.13 EDGE LINES

Kerbed roads in urban areas are generally not edge lined.

Un-kerbed roads in urban areas shall be provided with edge lines.

For edge lines on rural roads and Motorways **see 3.4.7.**

3.3.14 ON-STREET PARKING CONTROL

References: ARR Rules 169, 184, 195; OI 20.1

On-street parking control markings shall conform to the AS 1742.11, except as indicated below.

Generally parking control markings, such as lines, T's and L's used to delineate parking spaces are white.

Clearways, both part time and full time shall not be marked with edge lines.

ON STREET PARKING (continued)

Full time parking restriction lines i.e. continuous yellow lines may be used to designate No Stopping areas (with or without signs), but should not be used to designate No Stopping areas already covered in the Road Rules. They may be used in areas of high parking demand with a history of poor compliance with the road rules. In these situations, broken yellow lines may be used where stopping is restricted to particular vehicle types (i.e. at bus stops and post boxes) and continuous yellow lines may be used where the no stopping restrictions applies to all vehicles i.e. at intersections.

Where a section of No Stopping restriction for traffic management purposes is marked with a continuous yellow line and is directly adjacent a section of No Stopping already covered in the road rules, the yellow line shall continue for the extent of both No Stopping restrictions.

Rule 203A prohibits stopping in a slip lane, which, by definition, includes the length of dedicated left turn lane on the approach to the slip lane island. Where a left turn lane is not a slip lane, but instead is a left turn facility within the signalised intersection, there is no stopping provision under the ARR (except Rule 170 which prohibits stopping within 20 m of the intersection). Approaching drivers may not be aware whether the left turn lane is part of a slip lane arrangement or a left turn within the signalised intersection, particularly for long left turn lanes, and therefore may be unaware the stopping restrictions under ARR which apply. Where stopping within the left turn lane is required to be prohibited for traffic management purposes, No Stopping restrictions (see 3.2.3) shall be installed.

Painted yellow edge lines shall not be used in full time bicycle lanes. The use of these lines may cause confusion, with the potential for drivers to mistakenly interpret their use as implying that stopping is permitted beyond their extent.

Taxi zones must be signed and may be delineated with parking space markings.

NOTE: The yellow line at fire plug indicators (blue RRPM) and hydrants are the responsibility of SA Water.

3.3.15 PAVEMENT MESSAGES (Including Symbols)

References AS 1742.2 Section 5; Code of Technical Requirements

The length of letters and numerals shall be 2.5 m where the speed limit is up to 80 km/h and 5.0 m at higher speeds. A message should, if possible, be confined to one line. Where two or more lines are required, they shall be designed as follows:

- a) Where the 85th percentile speed is greater than 80 km/h, a separation of four times the character height shall be used, and the message arranged to read sequentially, i.e., with the first word nearest to the driver.
- b) At speeds lower than in Item (a), the separation between lines shall be from one-half to one time, the character height, and the message arranged to read from top to bottom.

PAVEMENT MESSAGES (Including Symbols) (continued)

Pavement messages on roads shall be limited to the following: (detailed references shown)

- Bicycle (symbol), **see 3.3.27**
- Bicycle Sharrow (symbol), **see 2.1.8.4** and *OI 9.4*
- BUS LANE, BUS LANE AHEAD, BUS ONLY, BUS ONLY AHEAD- **see 3.3.26**
- FERRY
- KEEP CLEAR **see 3.3.15.1** and *OI 2.23*
- LEFT TURN ONLY
- NO ENTRY
- Pavement Arrows **see 3.3.21.4**
- PED XING *refer DIT Supplement to AS 1742.10*
- RAIL X, **see 2.1.9**
- RIGHT TURN ONLY,
- SCHOOL, **see 3.3.25** and *Speed Limit Guideline for South Australia*
- SCHOOL XING, **see 3.3.24.3** and *DIT Supplement to AS 1742.10*
- School Zone (Zigzag), **see 3.3.25**
- SIGNALS AHEAD,
- Yellow Box Markings, **see 2.1.10**

Pavement messages other than those stated above shall be referred to the Manager, Traffic Services, DIT.

Speed Limit markings on the pavement shall not be used.

3.3.15.1 Keep clear

References: AS 1742.2 Section 5; OI 2.23

The keep clear pavement message shall only be used in accordance with *Operational Instruction 2.23 KEEP CLEAR Pavement Markings*.

- Keep clear pavement markings shall consist of the words “KEEP CLEAR”, and
- Be positioned wholly within a single lane where possible.
- Shall have 2.5 m letter height with 2.5 m spacing between words.
- Shall have a letter style as shown in *AS 1742.2* and **2.1.7.2**.

Where two or more lanes in the same direction are to be marked with KEEP CLEAR, the message may be staggered at wide side roads or driveways.

If the lane widths in the same direction are, on average, less than 3.3 m wide then a single KEEP CLEAR message may be used across 2 lanes or 2 messages across 3 lanes.

PAVEMENT MESSAGES (Including Symbols) (continued)

KEEP CLEAR

Single lane

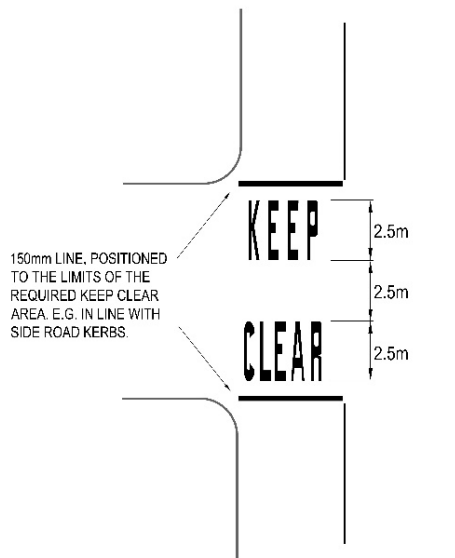

Multi-lane

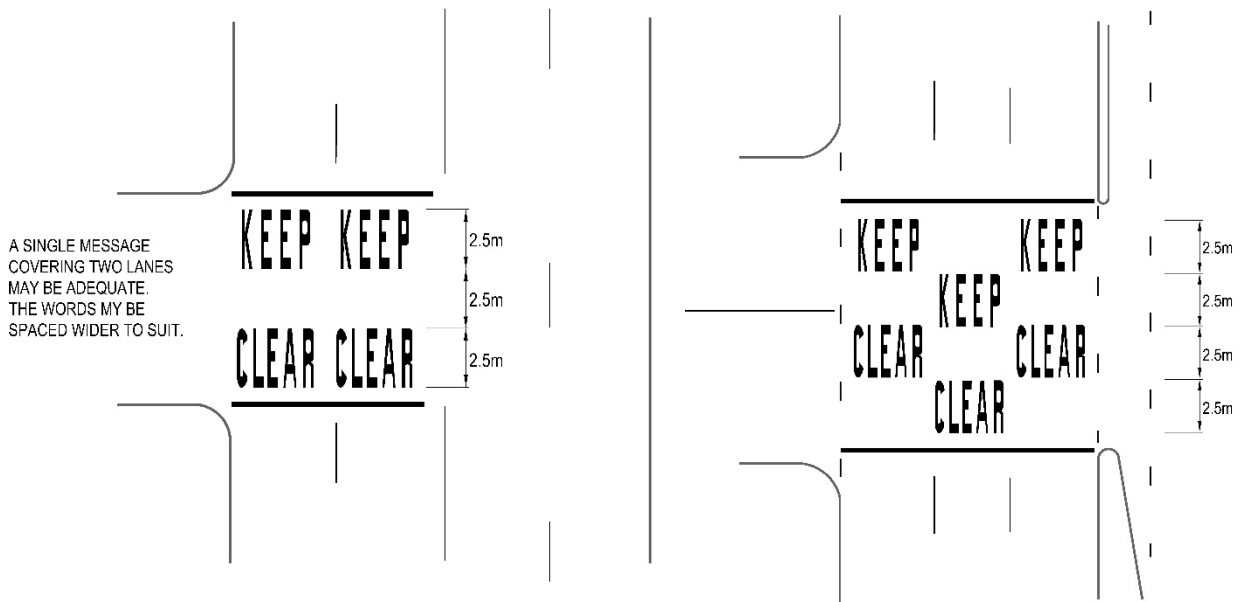

3.3.15.2 Speed limits

Speed limit pavement messages shall not be used in South Australia.

3.3.15.3 Other messages

Where it is desired to use other pavement messages, the matter shall be referred to the Manager, Traffic Services, DIT.

3.3.16 KERB EXTENSION MARKINGS

Reference: Standard Drawing S-4075 sheet 4

Kerb extensions are used to reduce road widths, especially in pedestrian crossing locations.

As the name suggests, kerb extensions should preferably consist of raised areas bordered by semi mountable median type kerbing. However, they may also consist of pavement markings designated by outline markings with diagonal stripes, and pavement bars and/or RRPMS.

Kerb extensions may also be used to physically control the movement of vehicles, such as a traffic divergence on a road section or to create a high angle entry to the main road.

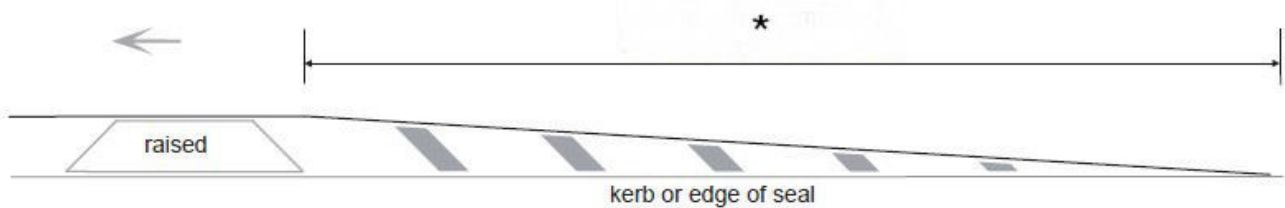

* Taper length determined in accordance with **3.3.8** and *GRD*.

NOTE: Diagonal stripes should be placed at 6 m spacing on the divergence taper section and then at 12 m spacing for long parallel sections up to 200 m. For sections longer than 200 m where diagonal stripes are considered necessary, they may be spaced at up to 24 m in urban areas and up to 48 m in high-speed rural areas.

KERB EXTENSION MARKINGS (continued)

3.3.16.1 Painted kerb extensions

Reference: ARR Rule 195

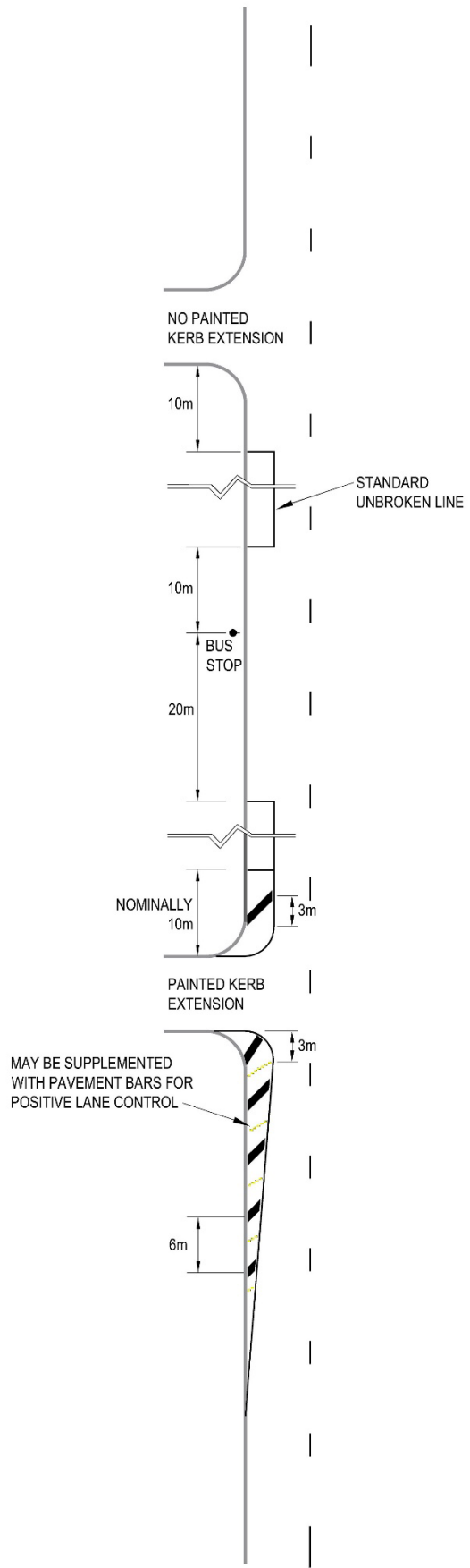

3.3.17 STANDARD INTERSECTIONS (Local Urban Roads)

Reference: ARR Rule 170

Local or minor roads < 12 m need not be line marked. Where the local road approach is > 12 m wide a single barrier line should be provided, preferably to the extent of the No Stopping restriction from the intersection (only) on the road with priority. **See 3.3.11.3.**

The controlled road approaches i.e. the road under Give Way or Stop sign control must be provided with a Give Way or Stop line. The provision of a barrier line from the Give Way or Stop line is preferred. **See 3.3.11.3.** The barrier line would not normally extend beyond 10 m from the kerb alignment of the intersecting road. This length of line matches the road rule which prohibits stopping within 10 m of an intersecting road.

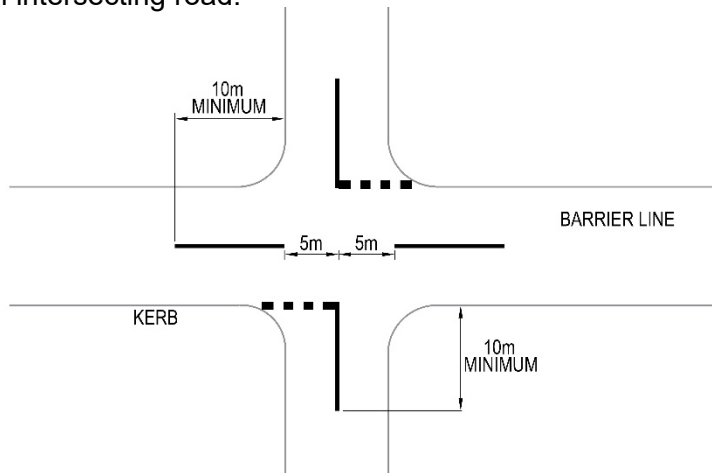

3.3.18 GIVE WAY AND STOP LINE MARKINGS

Reference: AS 1742.2 clauses 5.5.4 and 5.5.2

Line width for less than 80 km/h = 450 mm

80 km/h or greater = 600 mm

NOTE: Examples shown apply for both GIVE WAY and STOP locations. Maximum setback for Give way and Stop lines for swept paths is 3 m. For setbacks > 1 m, continuity line across the intersection should be considered.

3.3.18.1 At Roundabouts

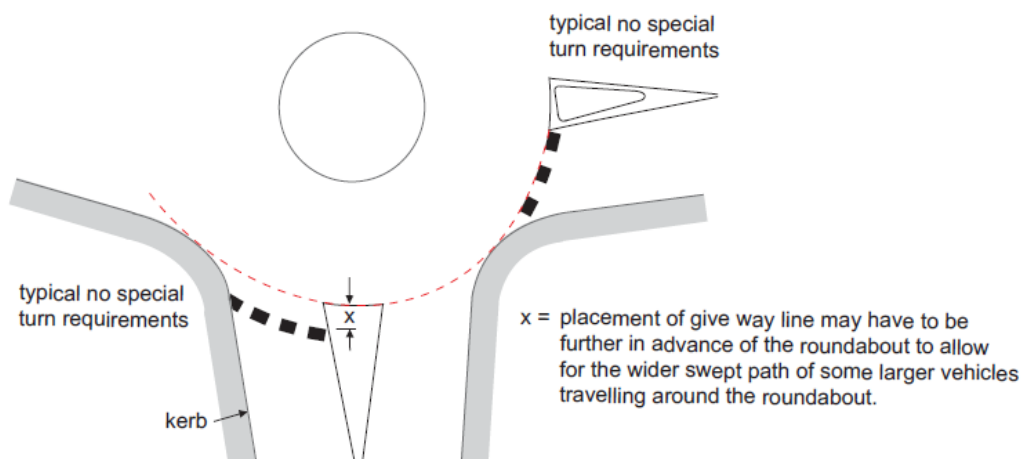

GIVE WAY AND STOP LINE MARKINGS (continued)

3.3.18.2 At T intersections

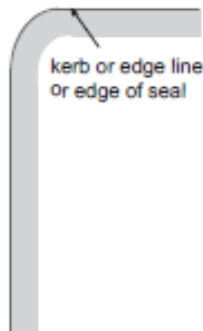
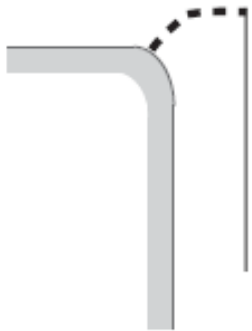
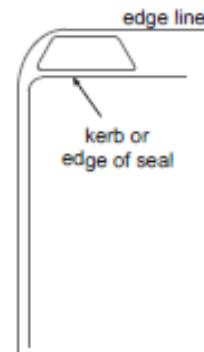
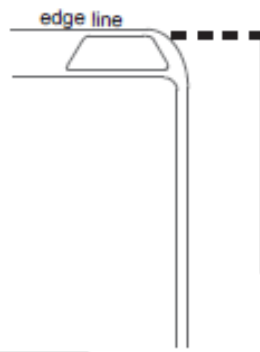
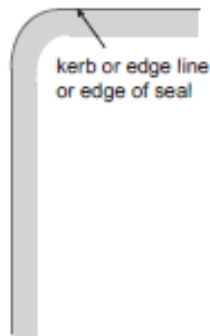
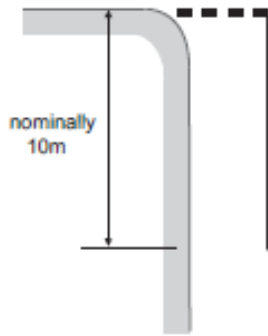

See 3.3.11 for position of continuity line

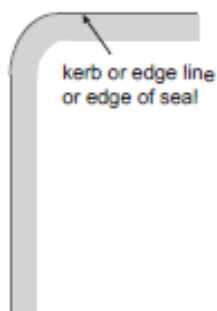
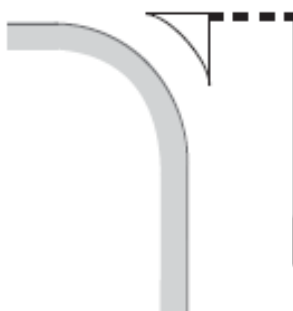
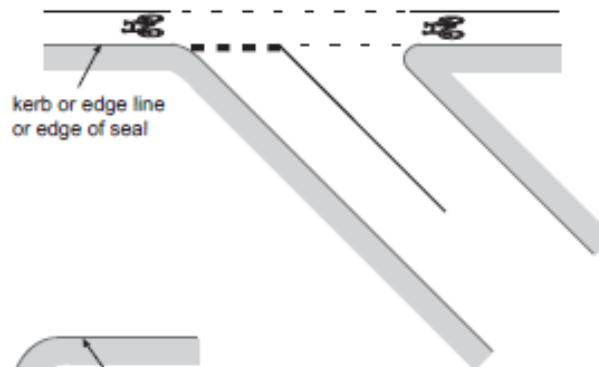

GIVE WAY AND STOP LINE MARKINGS (continued)

3.3.18.3 For left turns at un-signalised intersections

Reference: AS 1742.2 Clause 2.5.5(a)

A give way line **should** be installed where the left turn facility that has a raised/painted corner island in place, has potential conflict between a left turn at the slip lane and a vehicle performing a right turn into the same road.

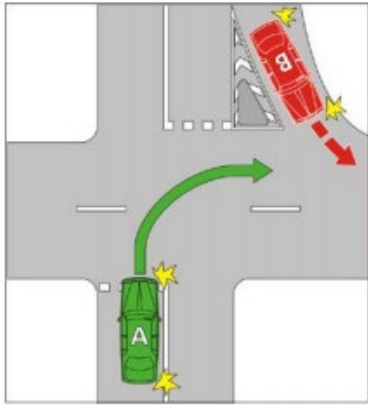

RULE 69 & 72 ARR

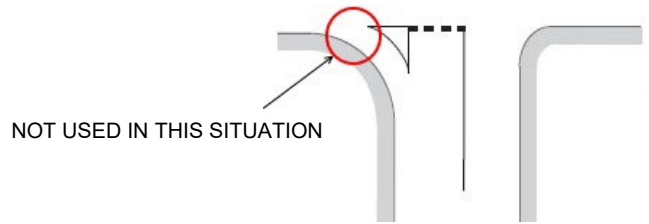

Driver turning right does not have to give way to oncoming vehicle that is turning left into the road the driver is entering using a slip lane

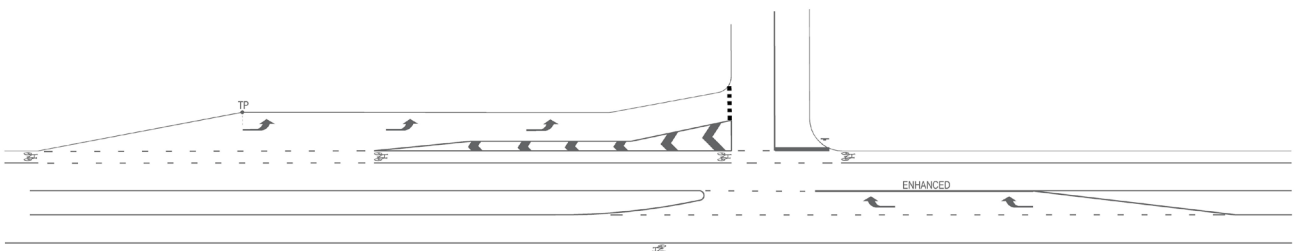
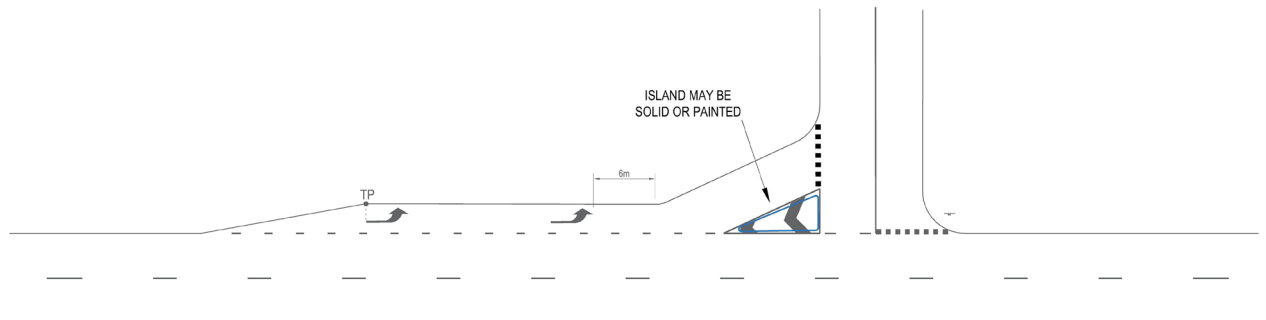
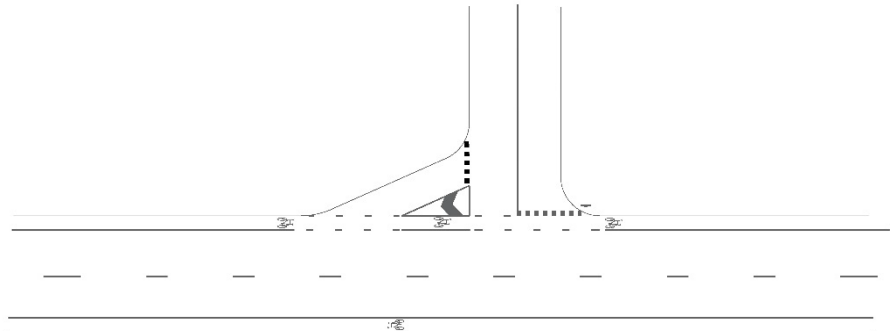

3.3.19 CHANGED PRIORITY

Changed priority intersection

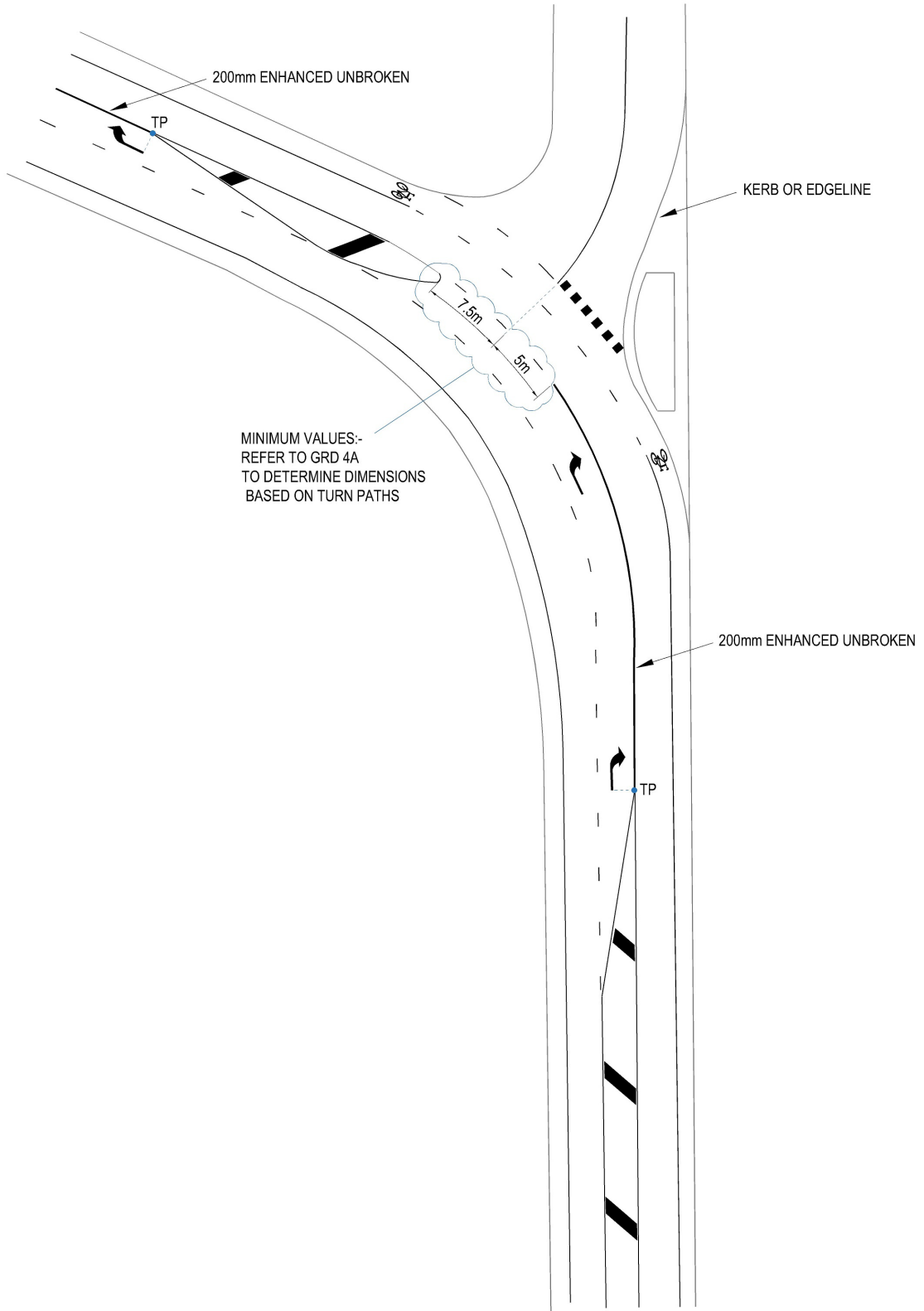

3.3.20 ROUNDABOUTS

Give Way lines

References: The Code Section 7; AS 1742.2 Section 2; AS 1742.2 Section 5; ARR Part 9

All roundabouts shall be provided with give way lines at the point drivers are expected to 'hold' to give way before entering the circulating lane(s). To determine the location of the give way line it is important to consider sight distance to approaching vehicles from the right while ensuring that the holding vehicle is not placed within the turning path of vehicles travelling within the circulating lane(s). **See 3.3.18.1.**

Special purpose and lane lines

Special Purpose line marking is used to denote lane lines around a multi-lane roundabout. Note that the spiral lane line markings i.e. where additional lanes are created within a roundabout, shall not be used in SA without the authorisation of Manager, Traffic Services, DIT.

Pavement arrows

Pavement arrows, while not used on single lane roundabouts, shall be used on any approach to the roundabout which has more than one lane.

Splitter islands

Splitter islands, raised or flush, shall be provided on each approach. A standard single continuous barrier line should be marked on the approach to a splitter island.

Painted kerb and outlines

All roundabouts, splitter islands and kerb extensions shall be painted and may be outlined. For semi-mountable central islands and splitter islands, **see 2.1.17.**

3.3.20.1 Single lane roundabout

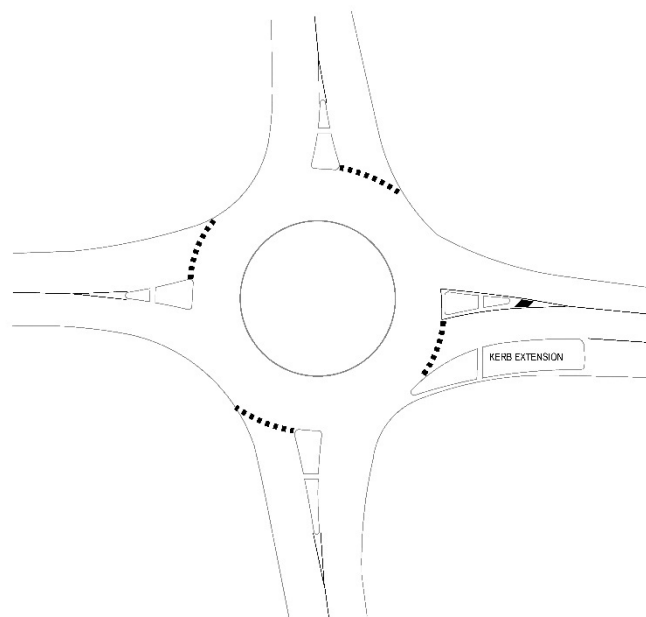

ROUNDABOUTS (continued)

3.3.20.2 Multi-lane T-intersection roundabout

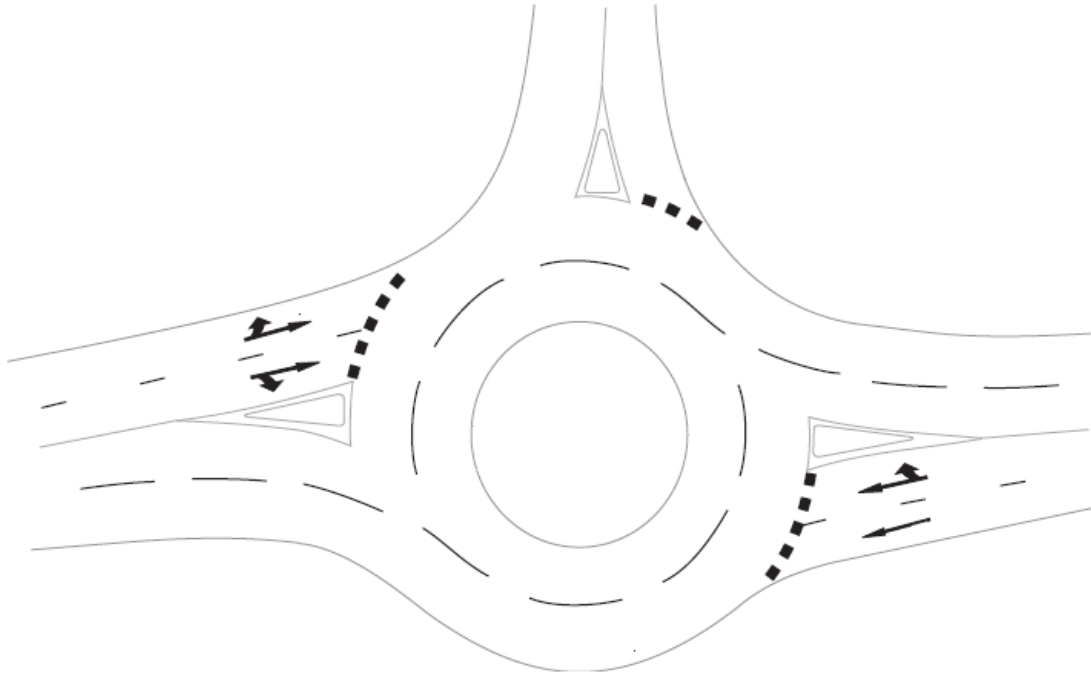

3.3.20.3 Bicycle lane approach and exit to a single lane roundabout

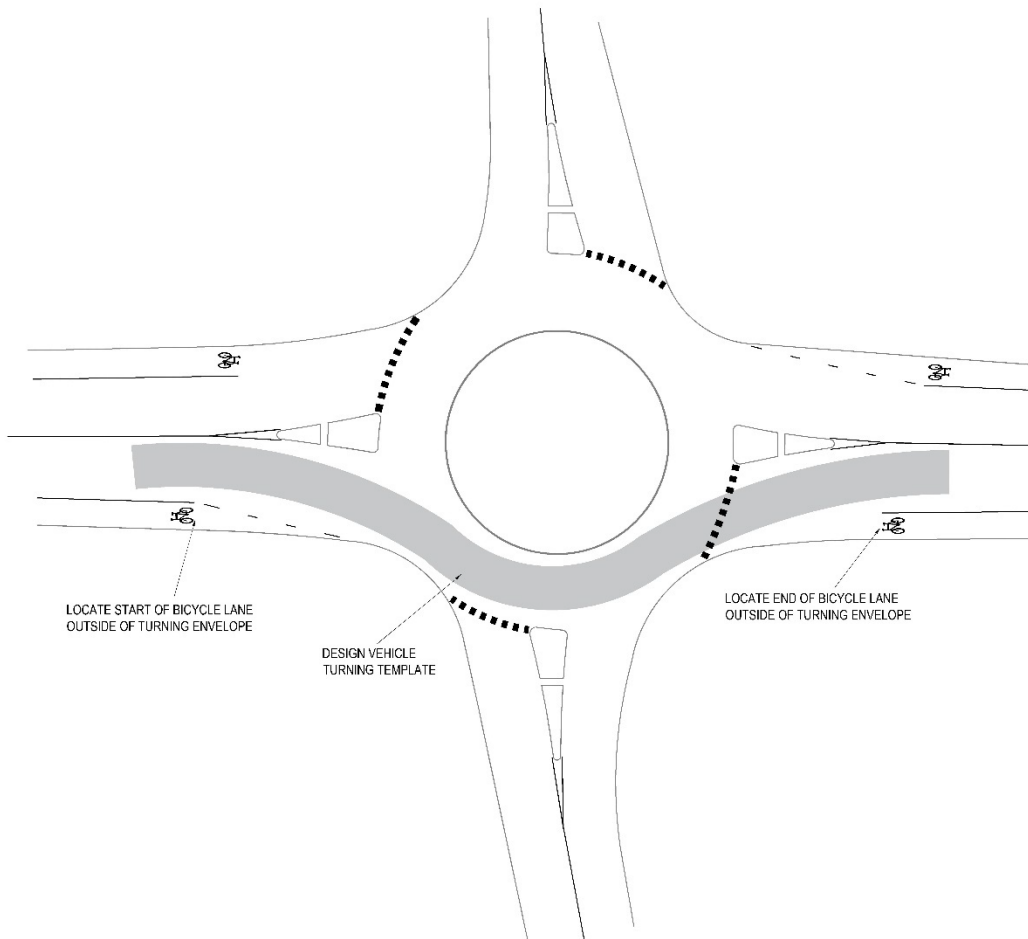

ROUNDABOUTS (continued)

3.3.20.4 Bicycle lane approach and exit to a multi lane roundabout

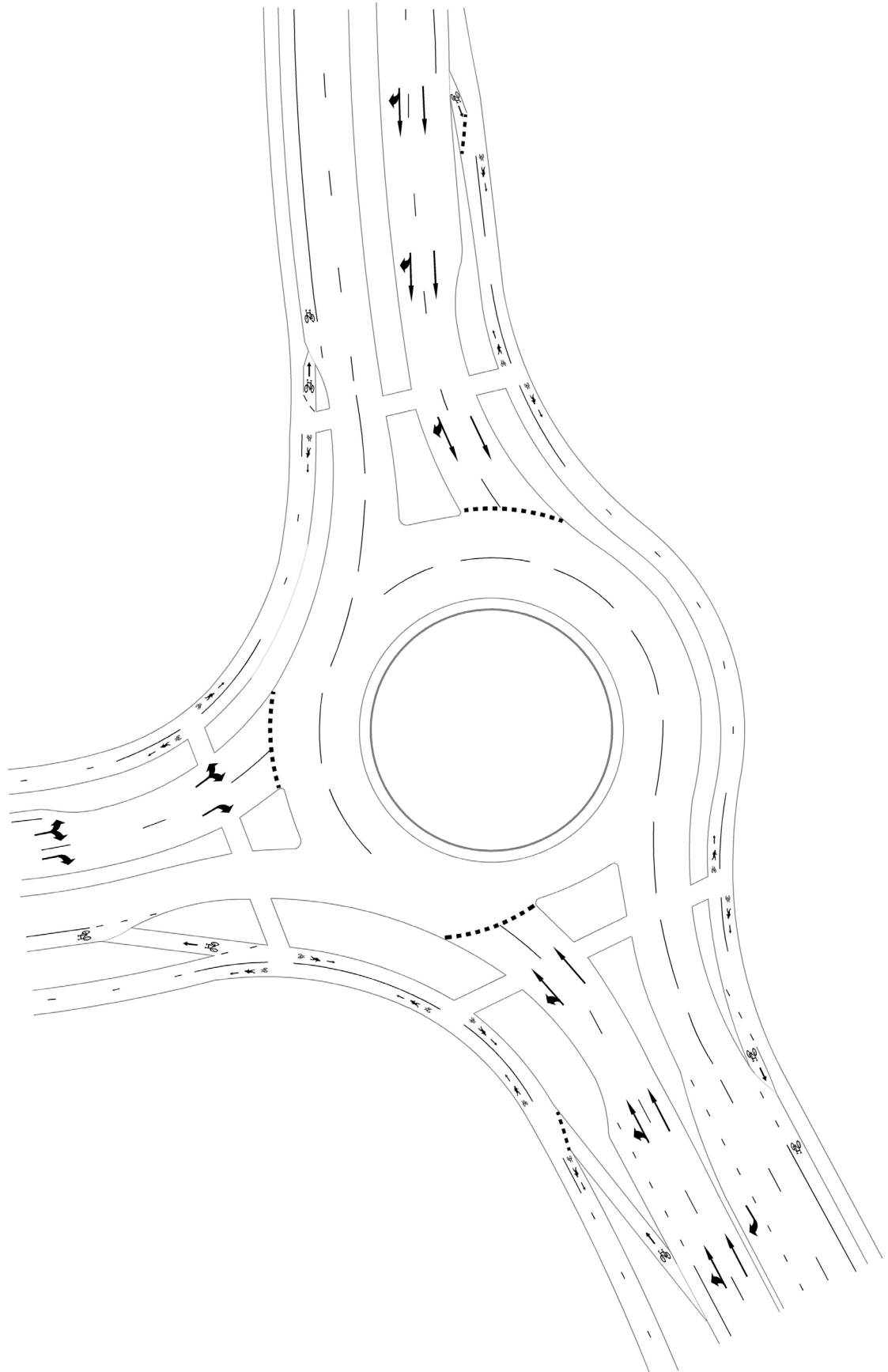

3.3.21 SIGNALISED INTERSECTIONS

Signalised intersection treatment index

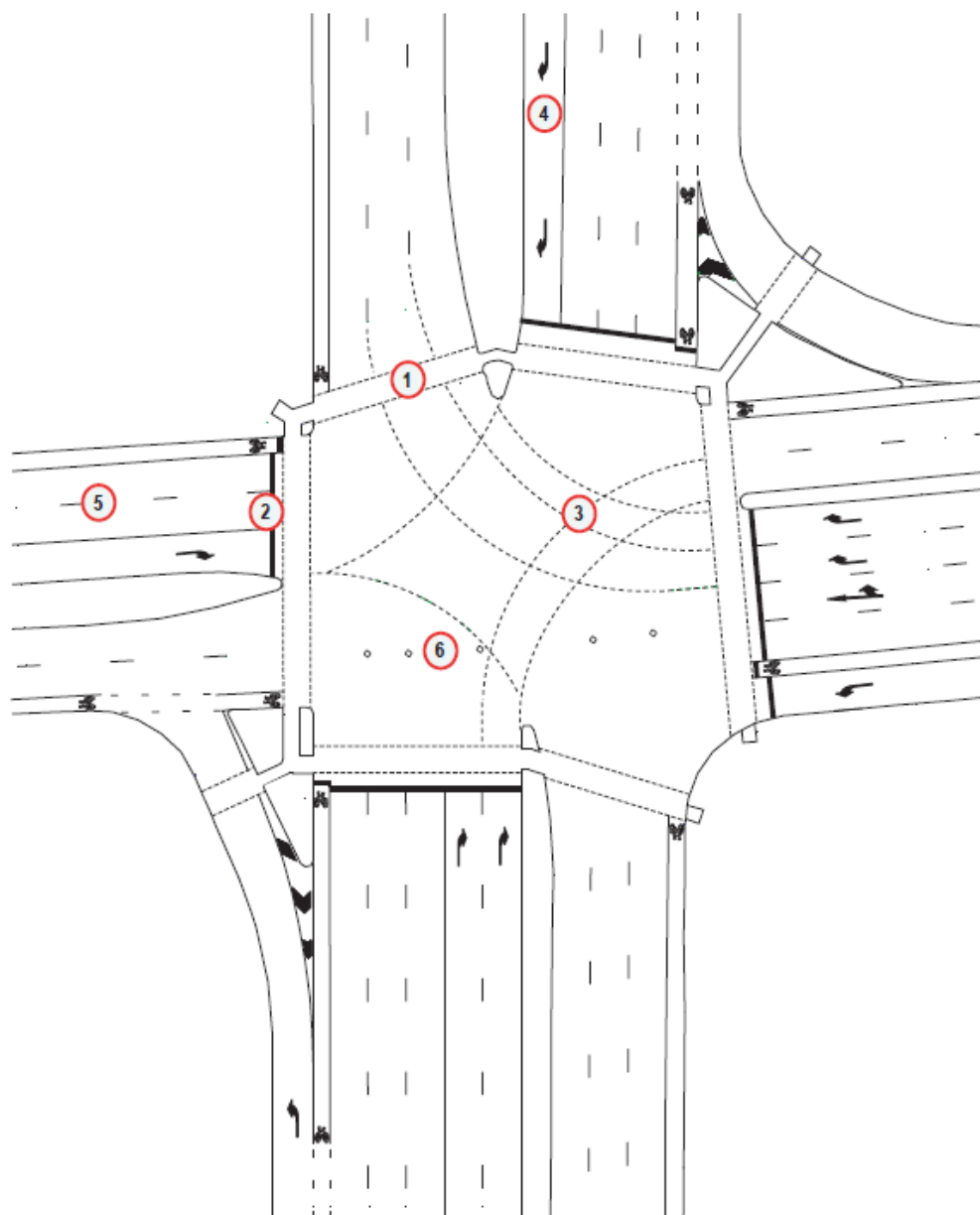

1. Pedestrian crosswalk lines - **See 3.3.21.1,**
2. Stop lines - **See 3.3.21.2,**
3. Turn lines - **See 3.3.21.3,**
4. Pavement arrows - **See 3.3.21.4,**
5. Lane lines - **See 3.3.21.5,**
6. Reflective pavement dots - **See 3.3.21.6,**

SIGNALISED INTERSECTIONS (continued)

3.3.21.1 Pedestrian crosswalk lines

References: AS 1742.2; AS 1742.10; AS 1742.14

a) Pedestrian

The marked crossing shall be a minimum of 2.4 m wide and delineated by two parallel lines. **See 2.1.2.3.** The width of the crosswalk may be increased where there are high pedestrian volumes. The line nearest the centre of the intersection should be > than 0.6 m (desirably 1 m) clear of the cross street kerb line projection.

Crosswalks shall always be on a straight alignment between staged crossing points.

No other lines shall be placed between the crosswalk lines.

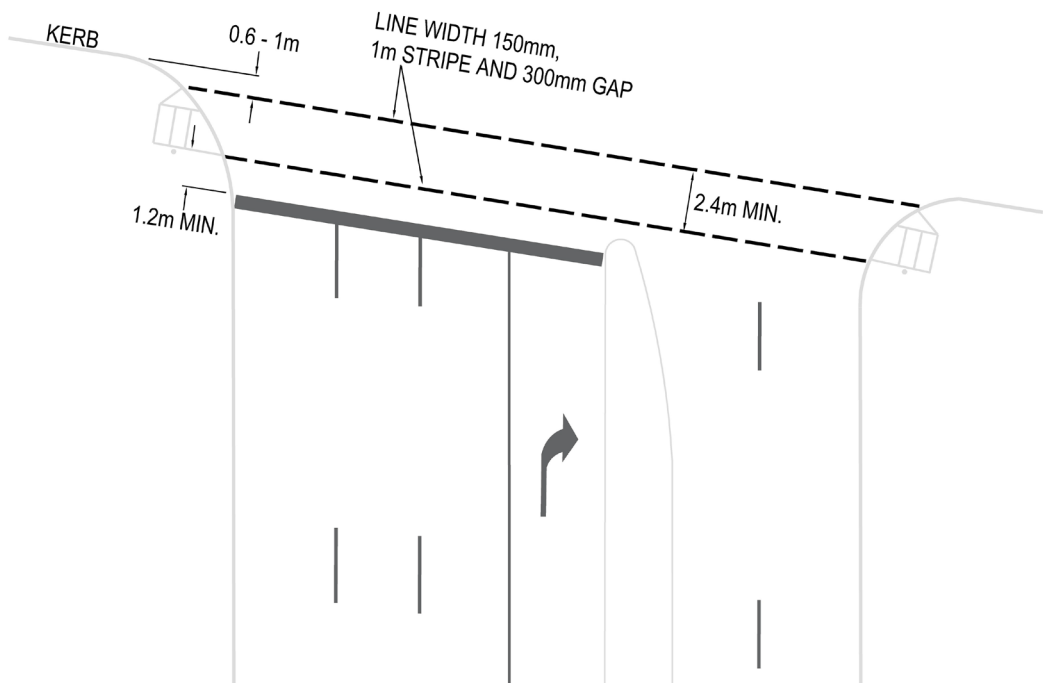

b) Shared Use

Shared use marked crossings may vary in width between 2.4 m - 4.0 m depending on the facility width leading to the marked crossing.

c) Scramble Pedestrian Crossings

Scramble pedestrian crossing markings are covered in *OI 14.1*.

SIGNALISED INTERSECTIONS (continued)

3.3.21.2 Stop lines

References: ARR Part 6; AS 1742.2; AS 1742.9; AS 1742.14; Standard Drawing S-4538.

a) Stop line and bicycle lane

Stop lines for bicycles should be placed ahead of the vehicular stop line so that drivers will be aware of bicycles waiting at the stop line prior to the start of the green period.

If an Audio Tactile Bicycle Push Button (ATBPB) is to be installed, be sure that the cyclist can reach it without the bicycle going over the stop line. Ideally the rider should be able to easily reach the ATBPB with the front wheel of the bicycle at the stop line. Therefore, the pole for the ATBPB would be located approx. 1 m behind the stop line.

The stop line for vehicles should be located not more than 3 m in advance of the primary signal post. This applies to mid-block signal stop lines as well.

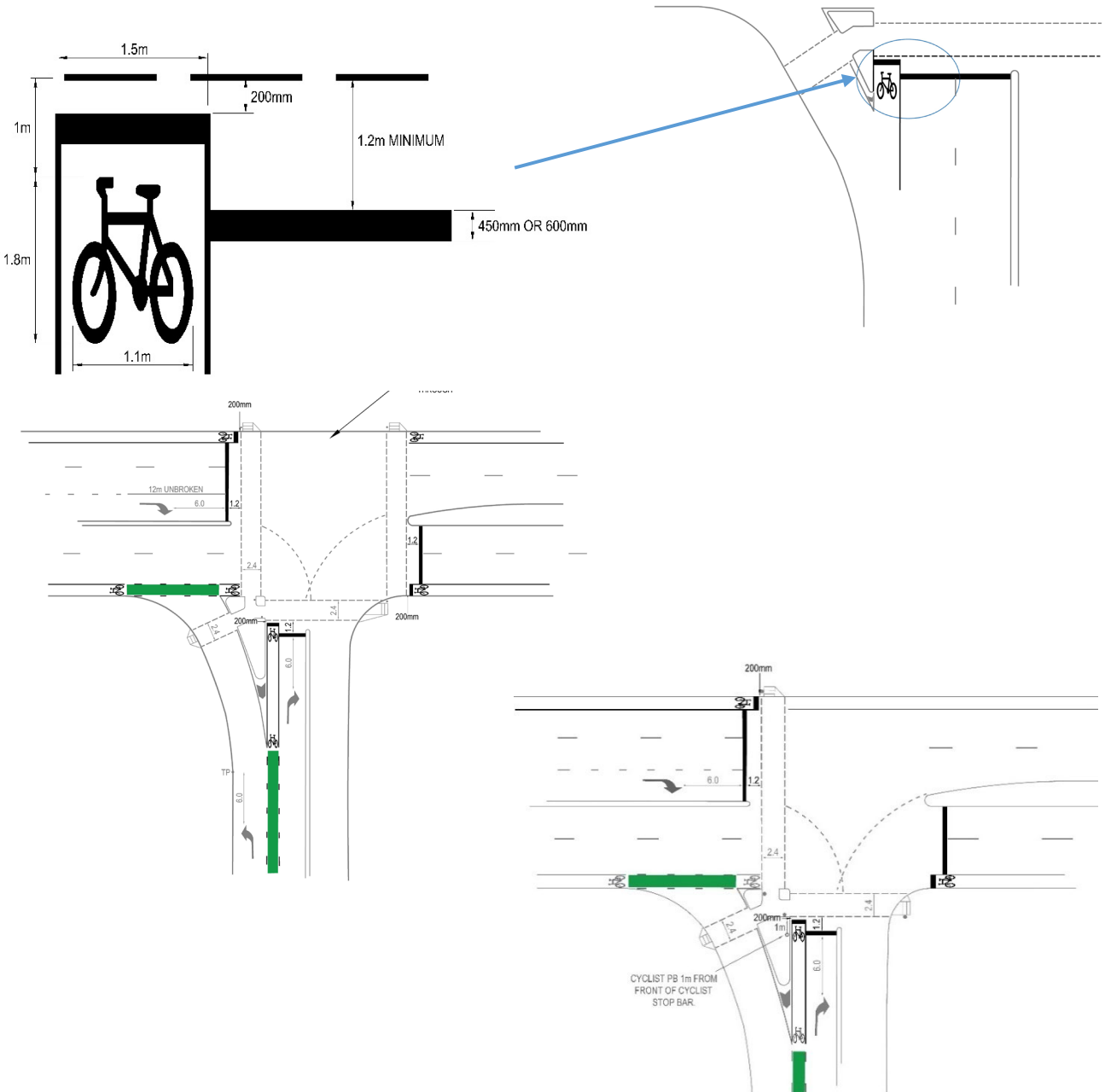

SIGNALISED INTERSECTIONS (continued)

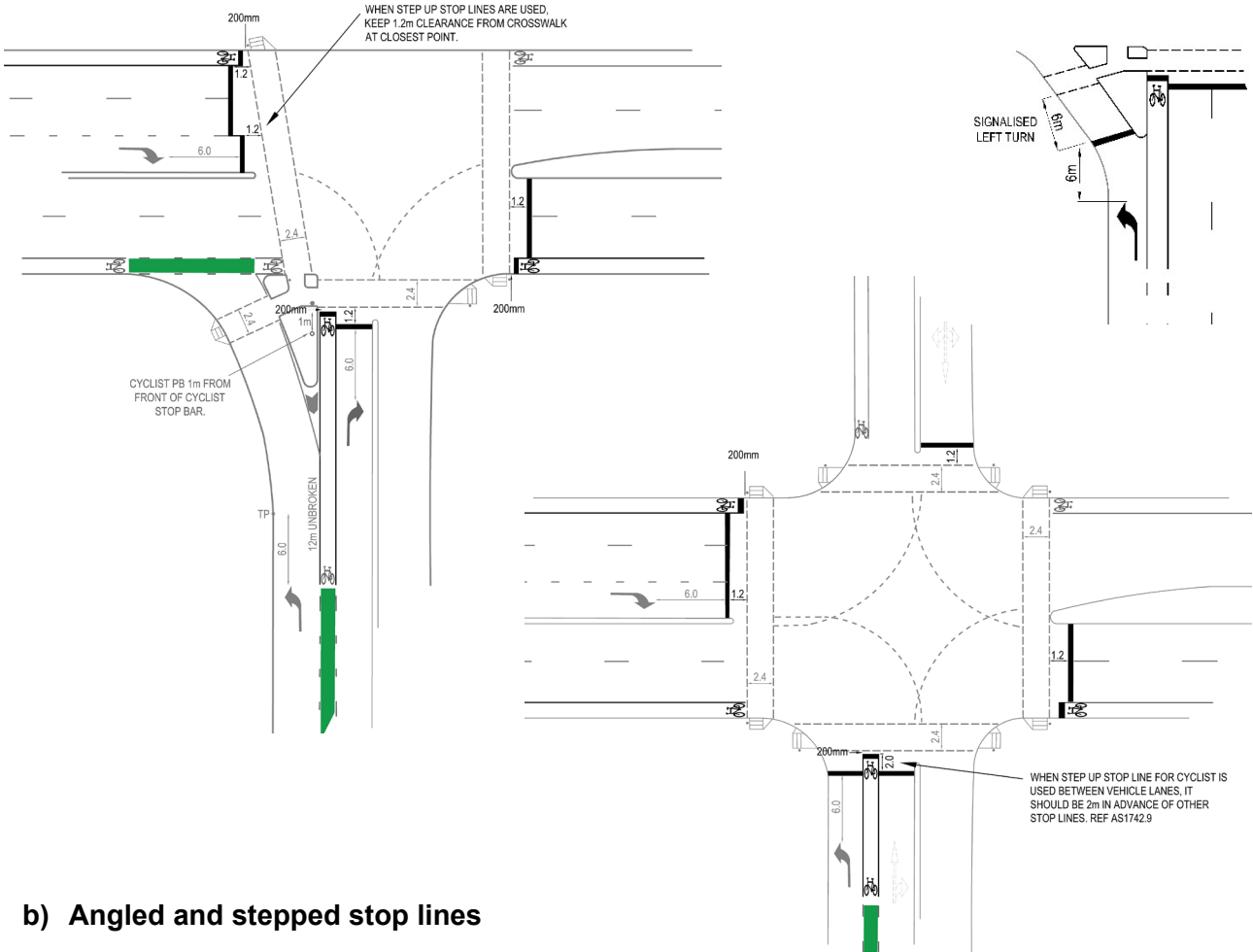

b) Angled and stepped stop lines

The correct stopping position at an angled stop line is often difficult for drivers to accurately determine when the angle of the line is less than 60 degrees to the direction of travel. Generally, it is preferred to use shallow angle stop lines but this will sometimes depend upon site suitability.

NOTE: 90 degrees to the direction of travel or stepped stop lines are required for safety camera installations.

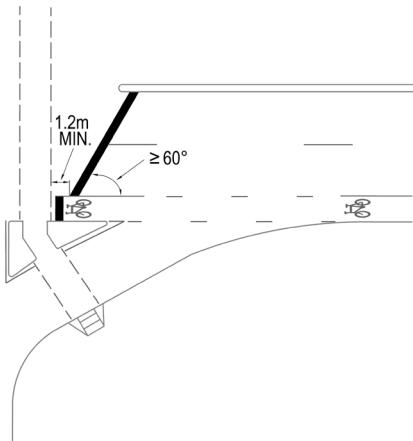

GREATER OR EQUAL TO 60 DEGREES TO THE DIRECTION OF TRAVEL, ANGLED STOP LINE CAN BE USED

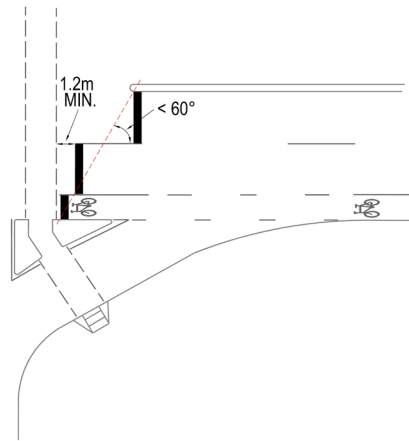

LESS THAN 60 DEGREES TO THE DIRECTION OF TRAVEL, USE STEPPED STOP LINE

SIGNALISED INTERSECTIONS (continued)

3.3.21.3 Turn lines

References: AS 1742.2; AS 1742.14 Clause 6.2.4

Turn lines should generally be used only at intersections with traffic signals. Turn lines may be used within signalised intersections to indicate the proper course to be followed by turning vehicles. They shall always be used within an intersection where there is more than one turning lane for turns in a particular direction. They are not required when the path to be followed is obvious to drivers under all conditions. Note that these lines are only installed for the inside of the lane path.

Turn lines should not be carried through pedestrian crosswalks but may continue after to carry on guidance. The radius of the turn line should be as large as possible and not less than 7 m.

NOTE: For guiding non-turning traffic through an intersection with reflective pavement dots, see 3.3.21.6. Turn lines may be used for non-turning (through) traffic at highly skewed intersections where the travel distance within the intersection is excessive (e.g. Port Rd/George St; Thebarton). Travel distance through intersections may be excessive due to factors such as wide medians, more than three through lanes, bus lanes, tram lanes and multiple turn lanes. Skewed bicycle lanes and potential conflict within the adjacent traffic lane may also be taken into account.

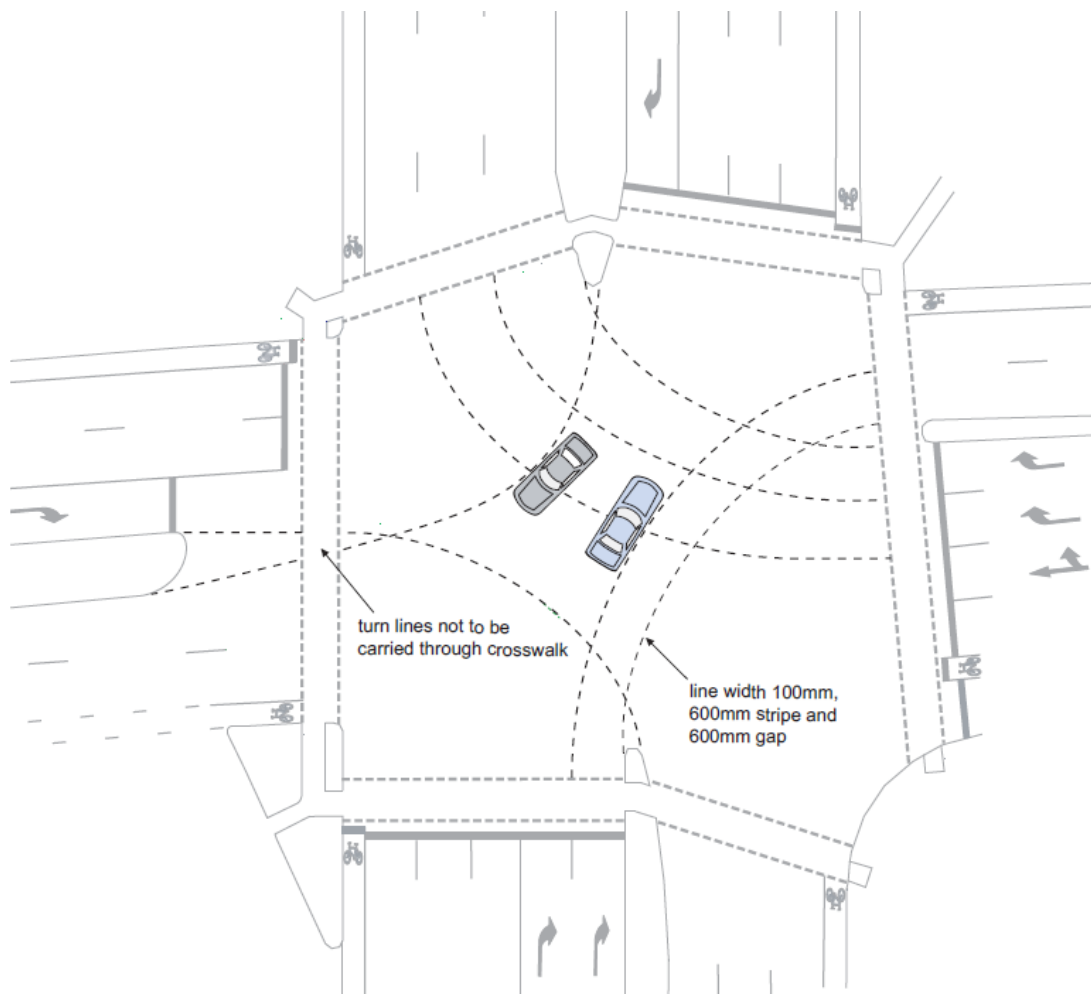

SIGNALISED INTERSECTIONS (continued)

3.3.21.4 Pavement arrows

References: ARR Rule 92; ARR Part 4; AS 1742.2 Clause 5.7.2

Drivers are legally required to travel in the direction of the arrow at the intersection. Arrows shall only be used in lanes where the movements differ from the ARR (refer to the Intersection Pavement Arrows Table (**see 3.3.22.4.2**)). For example, as drivers are permitted to turn left or travel through an intersection from the left lane, a pavement arrow indicating these directions shall not be used in the lane.

Intersection pavement arrows shall not be used:

- For turns that are restricted during certain hours of the day, or
- In bicycle and bus lanes.

When used, a minimum of 3 arrows shall be used on the approach to the intersection unless insufficient length is available (see below). The arrow closest to the intersection shall be placed 6 m from the stop line or from the tangent point of the start of a curve for a turn lane. The last arrow shall be marked at a point where the full width of the lane occurs (**See 3.3.21.4.1**). Arrows between these two should be equally spaced as close to 30 m as possible (tail to tail). However, to ensure a minimum of three arrows are provided, spacing may be reduced to a minimum of 15 m.

The minimum number of three arrows may be reduced when the lane is short or access to a side road is permitted such that there is insufficient length to physically install the arrows at the minimum 15 m spacing. In such cases the last arrow shall be aligned with the end of the opening.

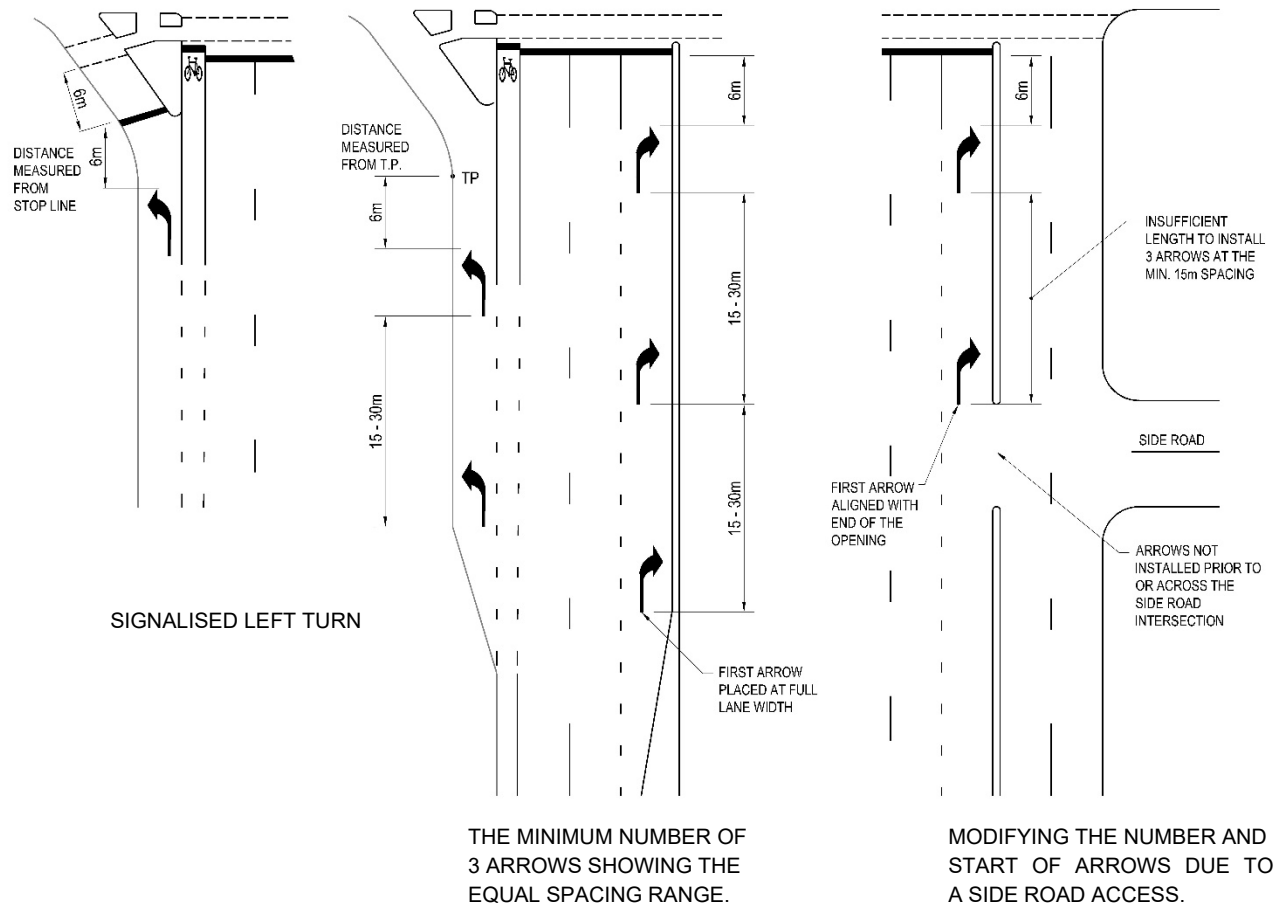

SIGNALISED INTERSECTIONS (continued)

3.3.21.4.1 Multiple turn lane examples

Reference: AS 1742.2 Section 2, Clause 5.7.2

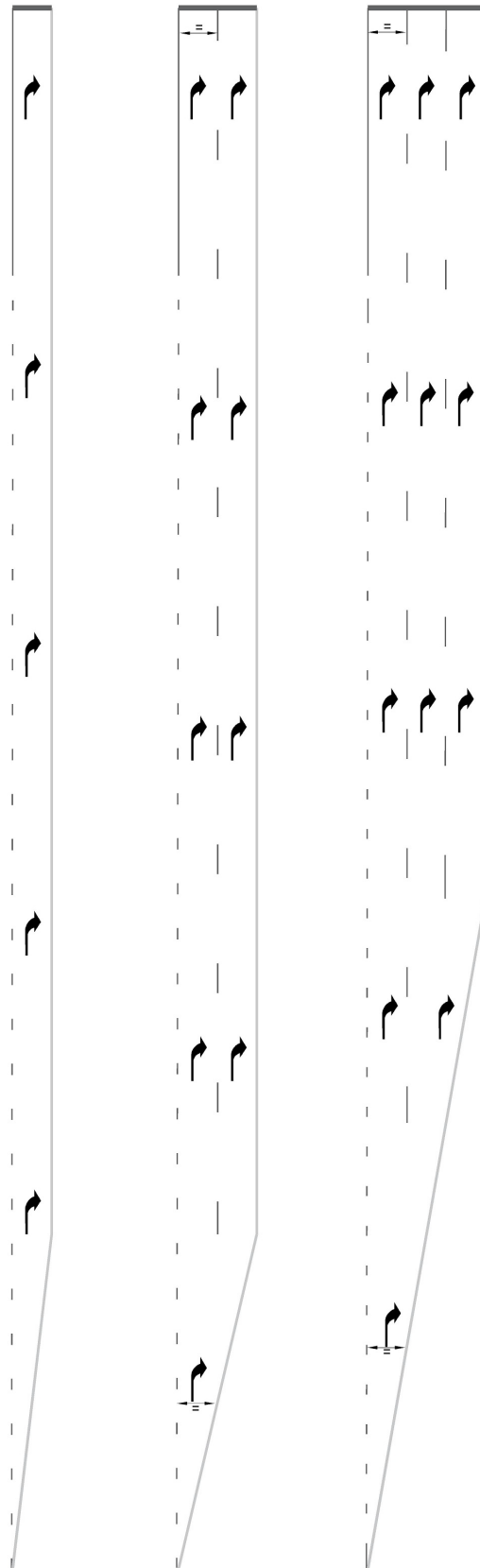

SIGNALISED INTERSECTIONS (continued)

T-Intersection combinations of left/right arrows are required to allow the movements intended.

1 ROW ONLY

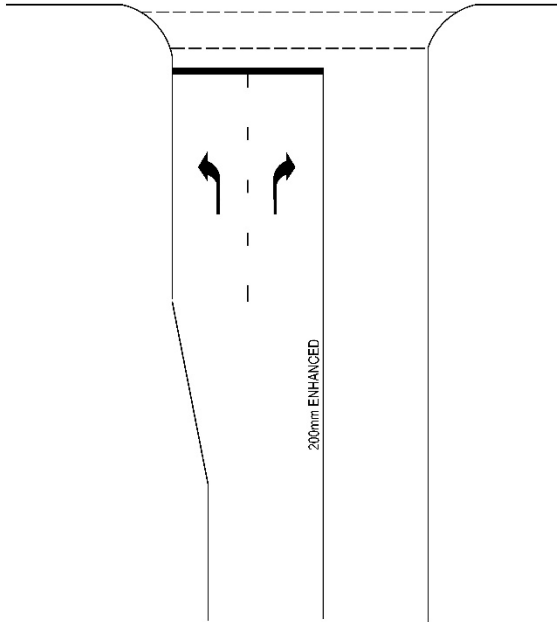

3 ROWS WHERE LENGTH PERMITS

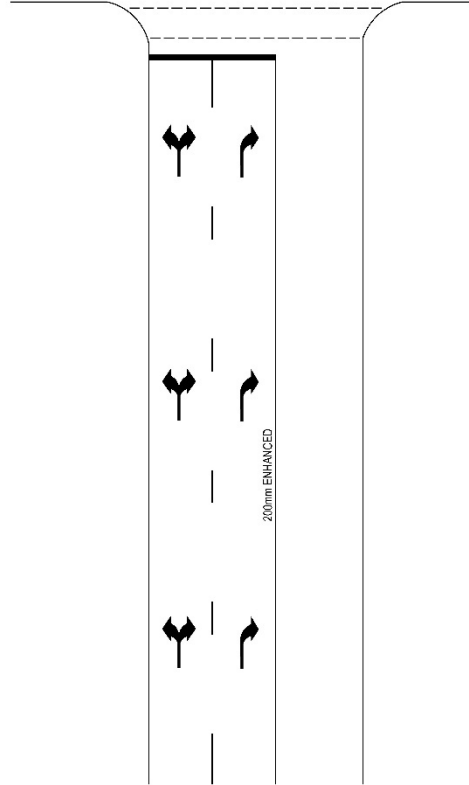

3 ROWS WHERE LENGTH PERMITS

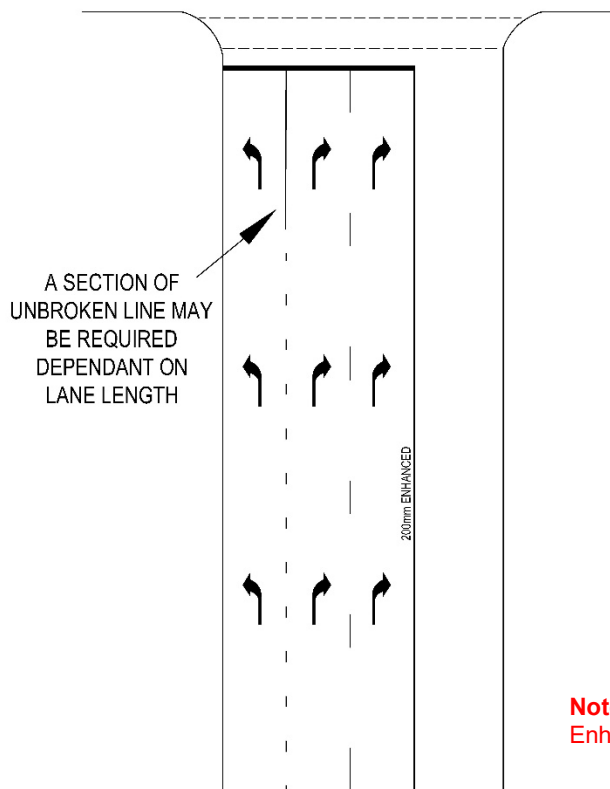

Note:
Enhanced for length of turn lane.

SIGNALISED INTERSECTIONS (continued)

3.3.21.4.2 Pavement Arrow Table

Description of requirements	Two lane	Three lane	Four lane
Legal manoeuvres if lane unmarked			
Legal manoeuvres if left lane only marked			
Legal manoeuvres if right lane only marked			
Markings for two exclusive left turn lanes			
Markings for two exclusive right turn lanes			
Markings for shared left turn and through from lane adjacent to left turn lane			
Markings for shared right turn and through from lane adjacent to right turn lane			
Markings for shared left turn and through from lane adjacent to two exclusive left turn lanes	NOT APPLICABLE		
Markings for shared right turn and through from lane adjacent to two exclusive right turn lanes	NOT APPLICABLE		
Markings to indicate left turn prohibition (signing also required, see Clause 2.8.5)			
Markings to indicate right turn prohibition (signing also required, see Clause 2.8.5)			

NOTES:

1. Full lines indicate arrows to be marked.
2. Dotted lines indicate manoeuvres which are permitted by regulations, but which need not be marked.
3. On some intersection approaches, it may be necessary to combine two or more of the marking methods shown.
4. Arrows for all movements shall be marked on multi-lane side road approaches to signal controlled "T" intersections and on all multi-lane approaches to roundabouts.

SIGNALISED INTERSECTIONS (continued)

3.3.21.5 Lane lines

References: ARR Rules 146, 147, 148

On the immediate approaches to traffic signals, the use of lane lines is essential where the approach width will accommodate two or more traffic streams. On the approach, lane lines should cease with a full line segment at the stop line. This may require a shorter gap segment, or a longer line segment.

On exits from intersections where pedestrian crosswalks exist, lane lines should start as close as practicable (but not closer than 300 mm) to the crosswalk.

For zip merges on the exit from intersections, **see 3.3.8.3.**

For the use of continuity lines as lane lines, **see 3.3.11.**

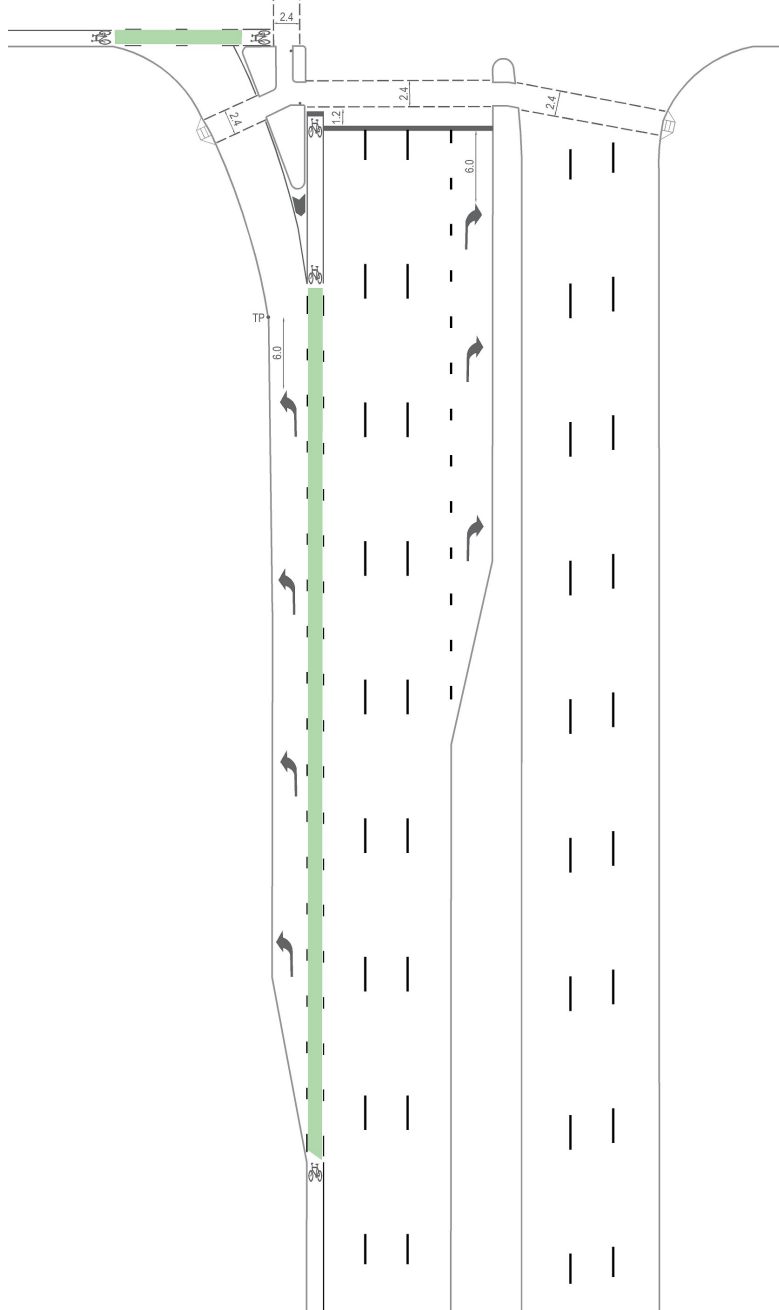

SIGNALISED INTERSECTIONS (continued)

3.3.21.6 Reflective pavement dots (RPDs)

For DIT roads the use of cold applied plastics dot instead of the standard poly dot is preferred for maintenance purposes. Alternatively, a round white reflective tape could be used.

Reference: AS 1742.2 Clauses 5.9.3, 5.9.5.3

Drivers may require guidance through intersections by the placement of RPDs within the intersection for non-turning traffic. Treatment is normally applicable only to wide signalised intersections on multilane roads. RPDs must be placed such that they do not interfere with the alignment of the cross-movement lanes.

Note that RPDs are only installed on the inside of a lane. (Driver's side)

Typical situations are:

- Lanes on opposite sides of the intersection offset by half a lane width or more.
- Drivers required to steer a curved course through the intersection.
- Highly skewed intersections where the travel distance within the intersection is excessive.
- Features such as tram lines or adverse geometry which may make the course difficult to follow.

Also see **3.3.21.3** for alternative use of turn lines.

Typical situation

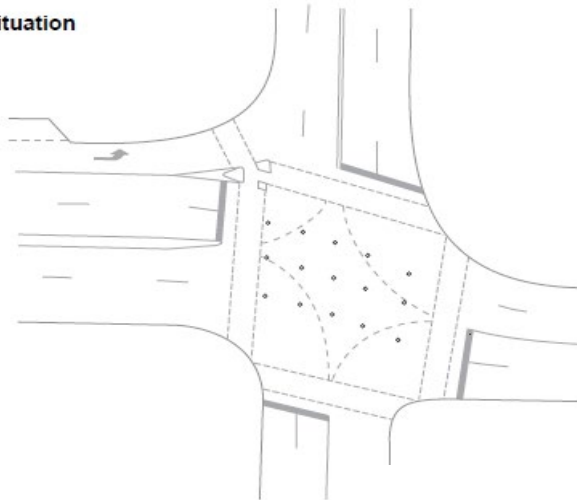

Location of guidance markers

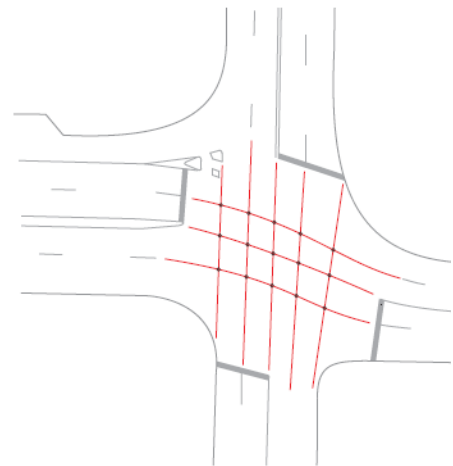

3.3.22 EXPRESSWAYS

For markings refer to AS 1742.2 Clause 3.7

Expressway exit lane arrows can be used for a single or multiple lanes exit onto a ramp where it is a trapped lane.

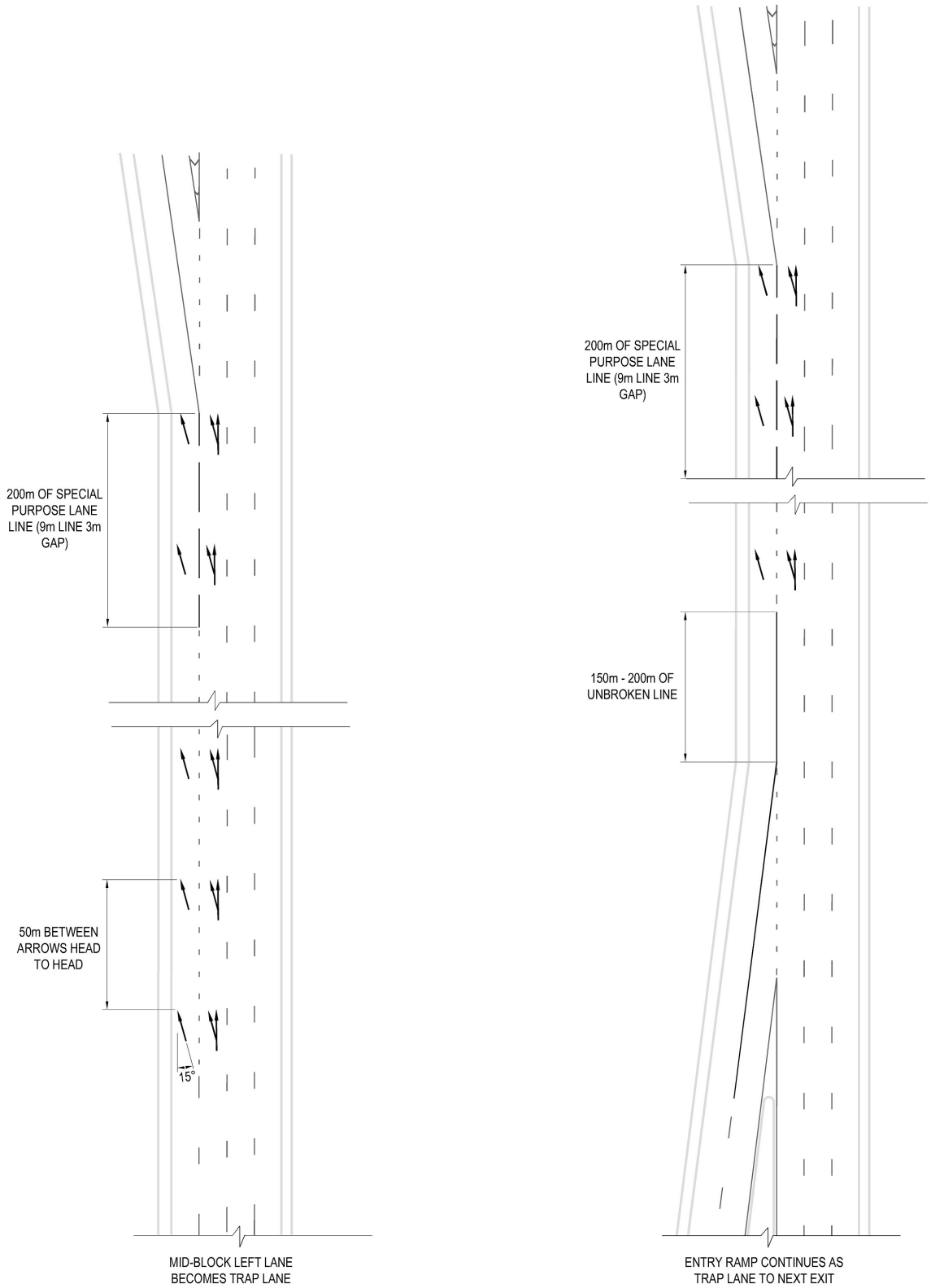

3.3.23 PATH TREATMENTS - TYPICAL LAYOUTS

Reference: AS 1742.9

3.3.23.1 Destination group layout

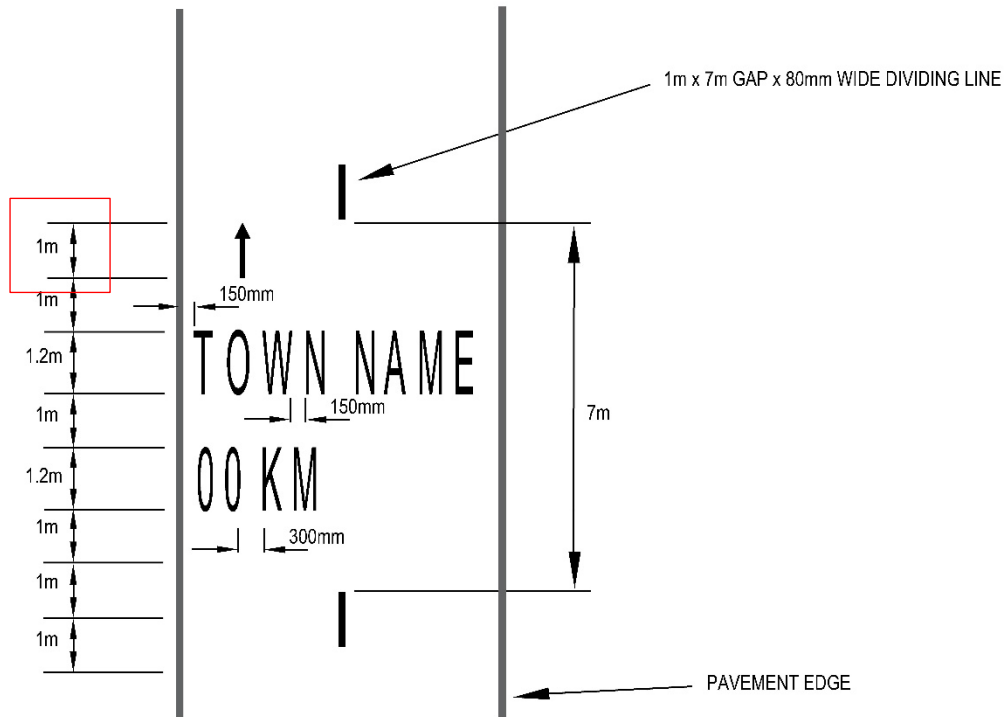

3.3.23.2 Connector group layout

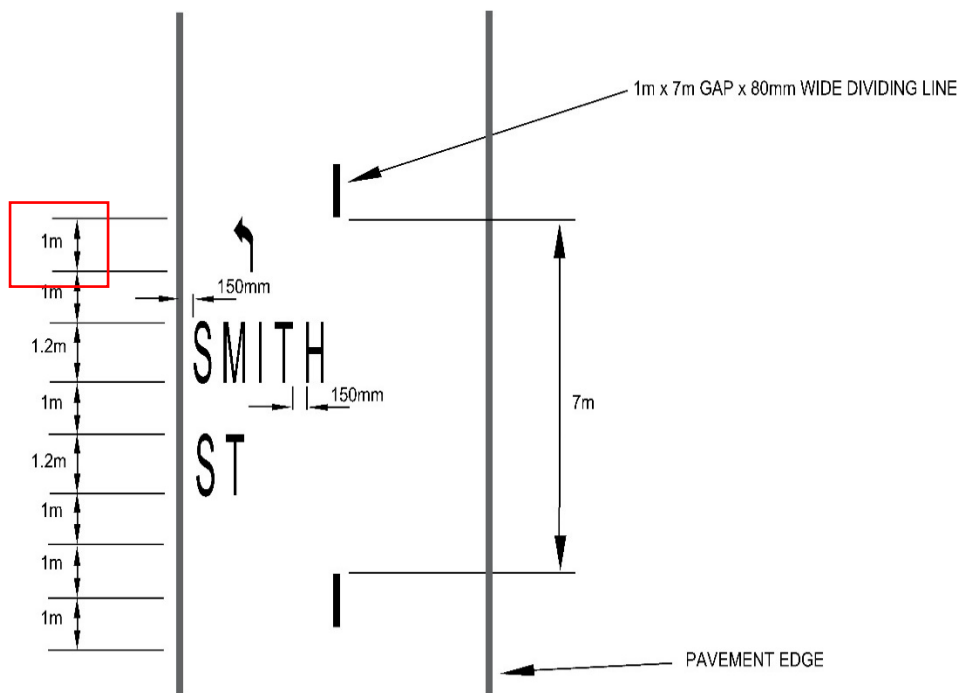

PATH TREATMENTS – TYPICAL LAYOUTS (continued)

3.3.23.3 Shared use paths, T intersection layout

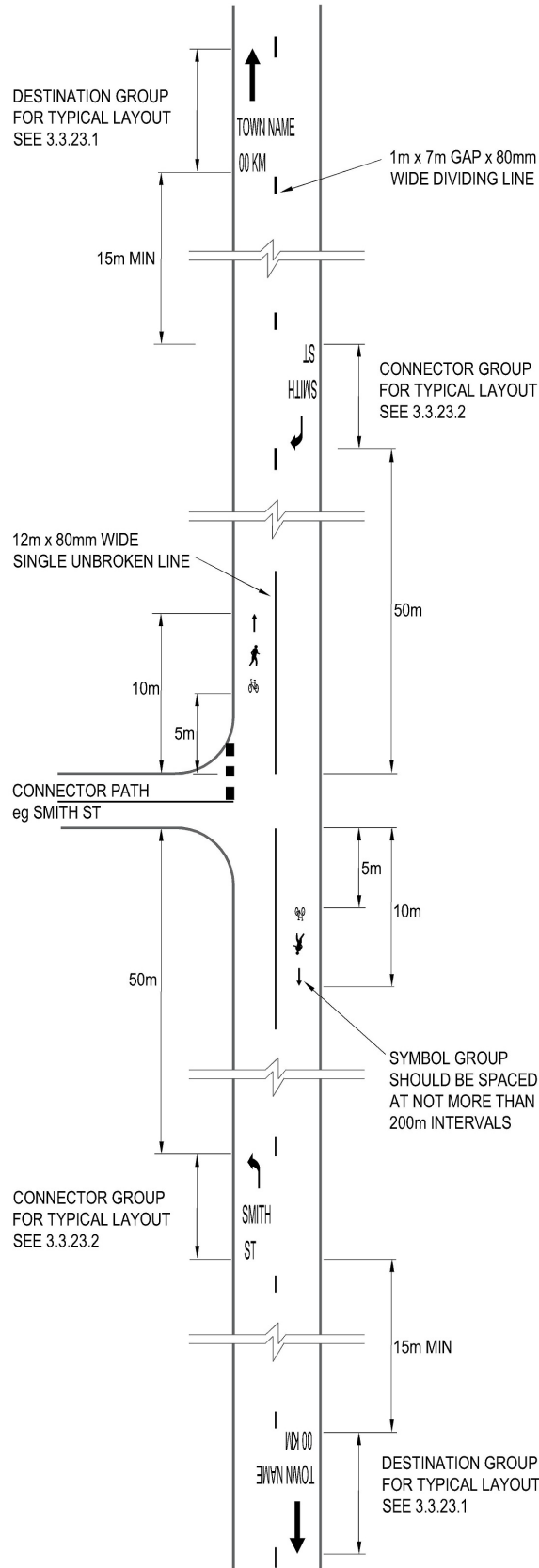

PATH TREATMENTS – TYPICAL LAYOUTS (continued)

3.3.23.4 Shared use paths, intersection layout

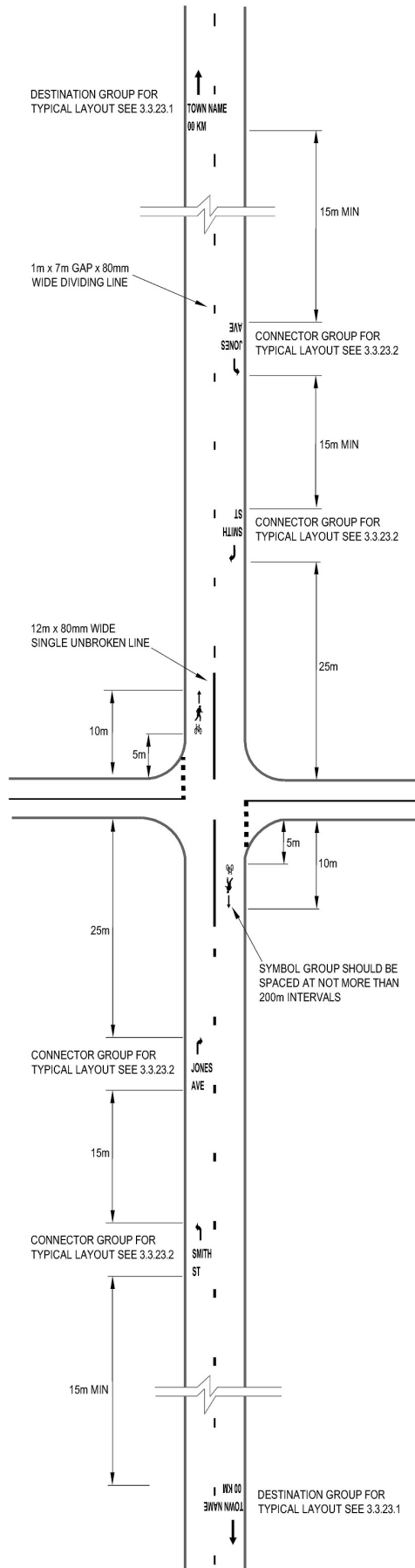

PATH TREATMENTS TYPICAL - LAYOUTS (continued)

3.3.23.5 Shared use paths, T intersection offset layout

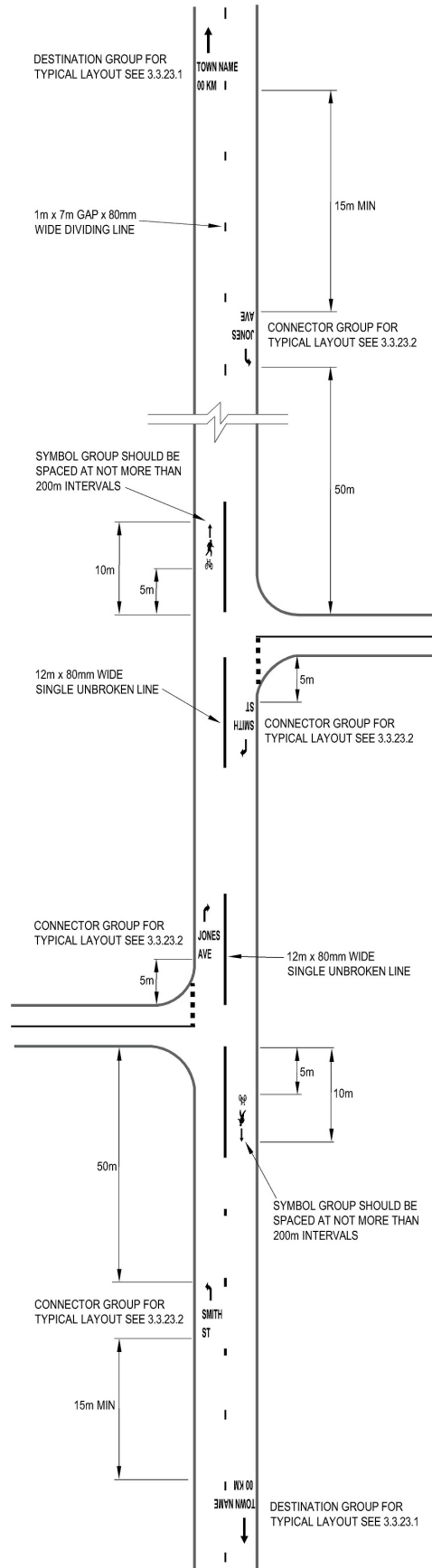

3.3.24 PEDESTRIAN FACILITIES

References: AS 1742.10; *DIT Supplement to AS 1742.10*

Facilities such as a Pedestrian refuge, Emu crossing, Koala crossing, Wombat crossing, and Pedestrian Actuated crossing, assist in the safe passage of pedestrians across roads. The legal effect for some of these facilities is partly created by the pavement markings.

3.3.24.1 Pedestrian refuge

Reference: *Standard Drawing S-4075 sheet 4*

Pedestrian refuges are either short lengths of raised medians used on roads for the sole purpose of providing a staging area for pedestrians crossing the road or are long lengths of median through which 'cut outs' or 'walkthroughs' may be provided. Refuges shall be outlined, and the outline shall continue past the pedestrian opening. Where pedestrian openings are provided through medians, outlines shall also continue past the opening, or a line placed across the opening as **shown in 2.1.17.5**.

Where the pedestrian refuge divides opposing traffic movements unidirectional yellow RRPMs shall be provided at 6.0m spacings. White RRPMs shall be provided at the same spacing where the refuge separates traffic travelling in the same direction.

**MULTI-LANE TWO-WAY UNDIVIDED AND
PREFERRED TREATMENT FOR TWO-LANE
TWO-WAY ROAD**

MINIMUM TREATMENT FOR TWO-WAY ROAD

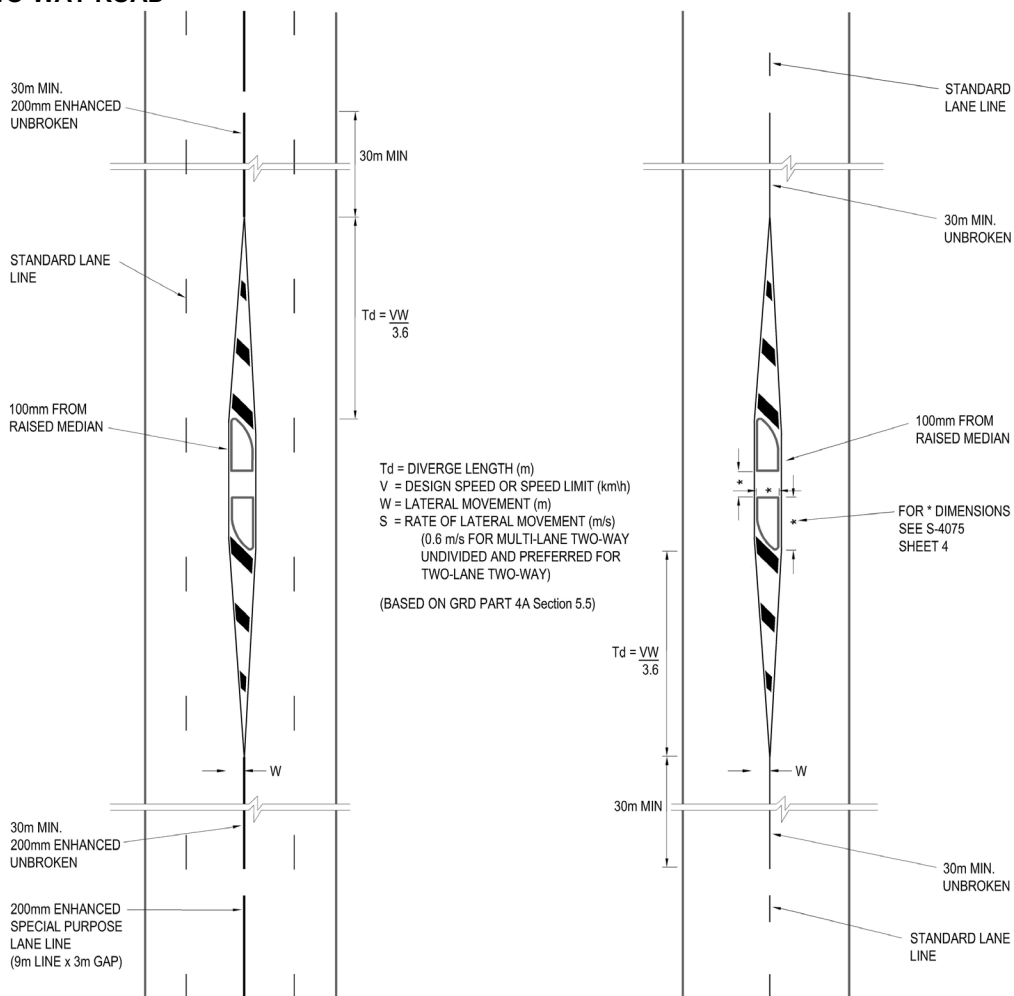

PEDESTRIAN FACILITIES (continued)

3.3.24.2 Emu crossing two-lane two-way road

References: *DIT Supplement to AS 1742.10*; AS 1742.10; ARR Rule 80

Two-lane two-way road

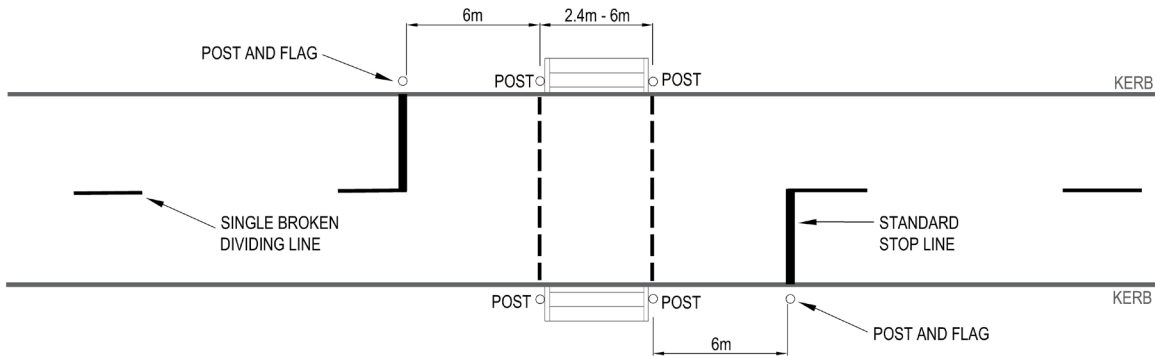

Two-lane two-way road (with kerb extensions)

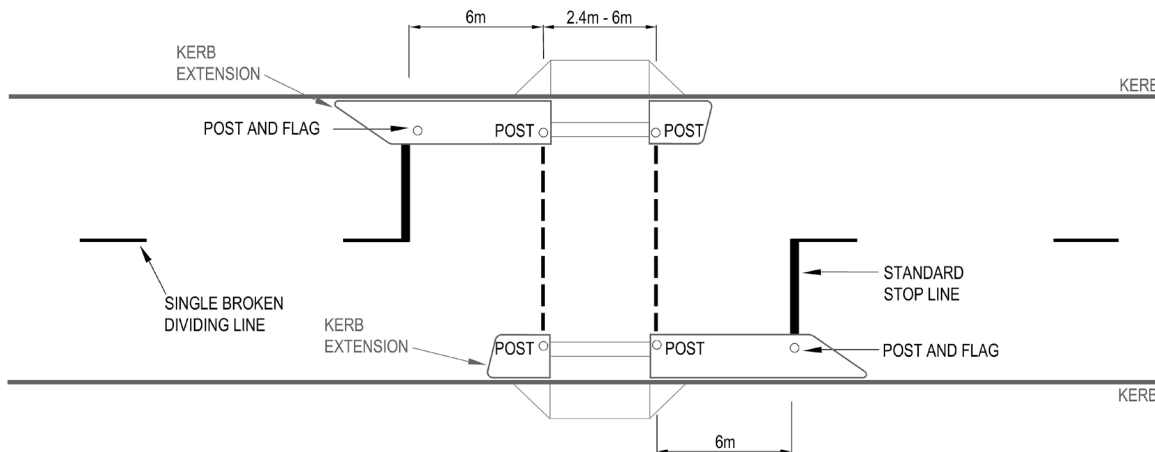

PEDESTRIAN FACILITIES (continued)

3.3.24.3 Koala crossing

References: AS 1742.10; *DIT Supplement to AS 1742.10*; ARR Rule 80

Two-lane two-way road

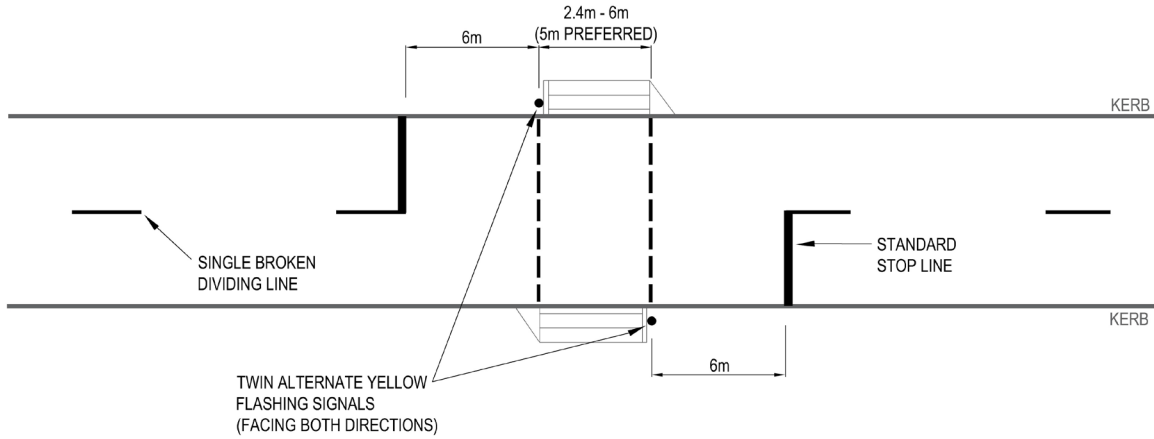

Two-lane two-way road (with kerb extensions)

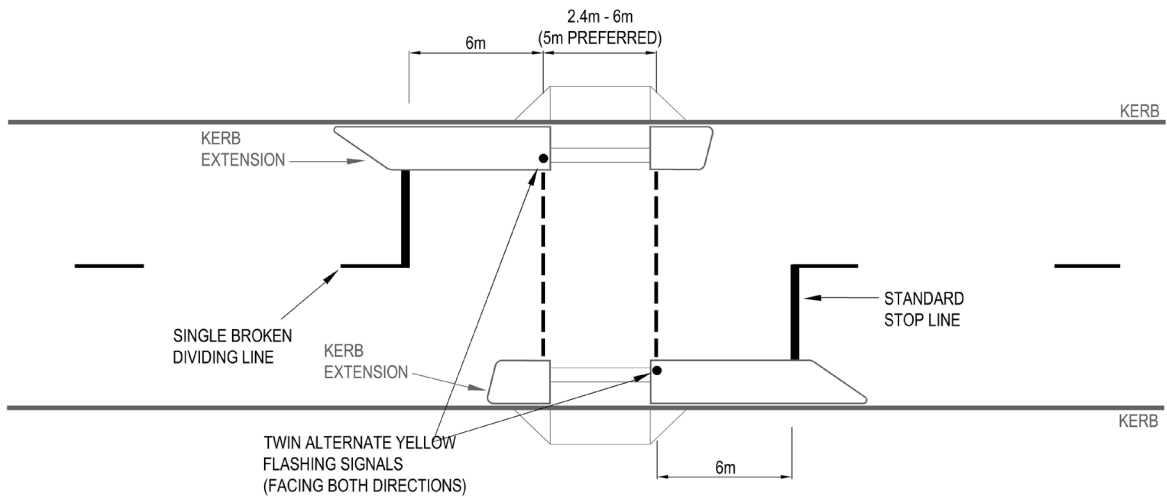

PEDESTRIAN FACILITIES (continued)

3.3.24.4 Wombat and Zebra crossings

References: Section 2.1.2.3(b and c); *DIT Supplement to AS 1742.10*; AS 1742.10; ARR Rule 81

3.3.24.4.1 Wombat crossing

Two-lane two-way road

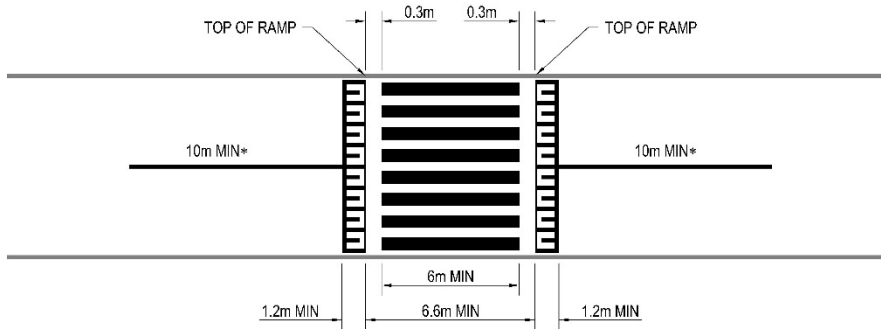

* A SINGLE BARRIER LINE SHOULD BE PROVIDED ON EACH APPROACH IF THE ROAD HAS A DIVIDING LINE.

Divided carriageway

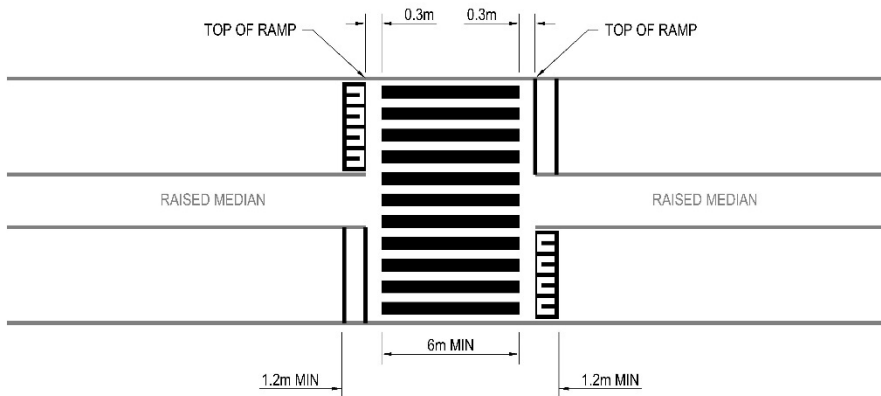

3.3.24.4.2 Zebra crossings

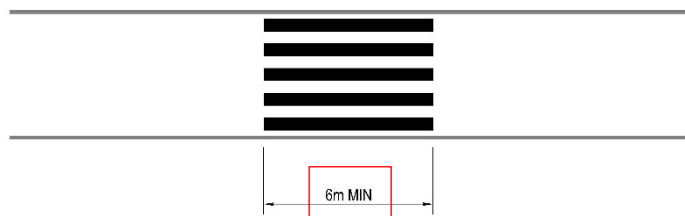

PEDESTRIAN FACILITIES (continued)

3.3.24.5 Pedestrian Actuated crossing

References: AS 1742.10 and Standard Drawings S-4018 sheets 7,8,9.

Undivided roads: Two-lane two-way

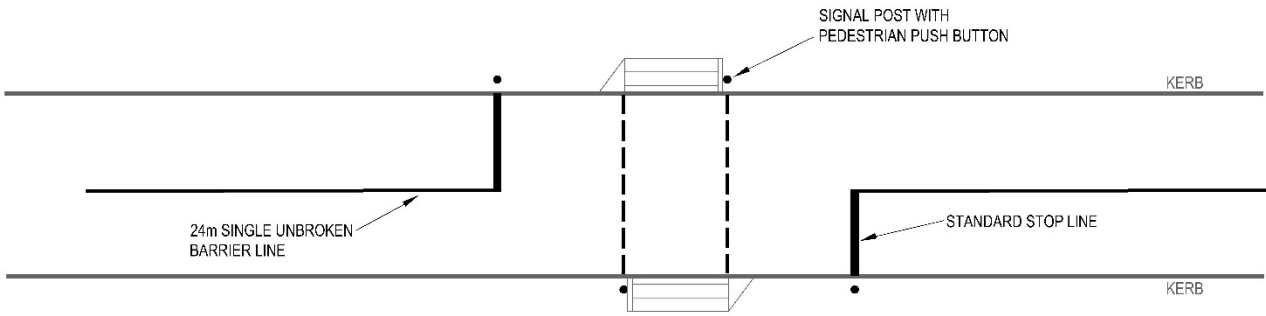

Undivided roads: Four-lane two-way

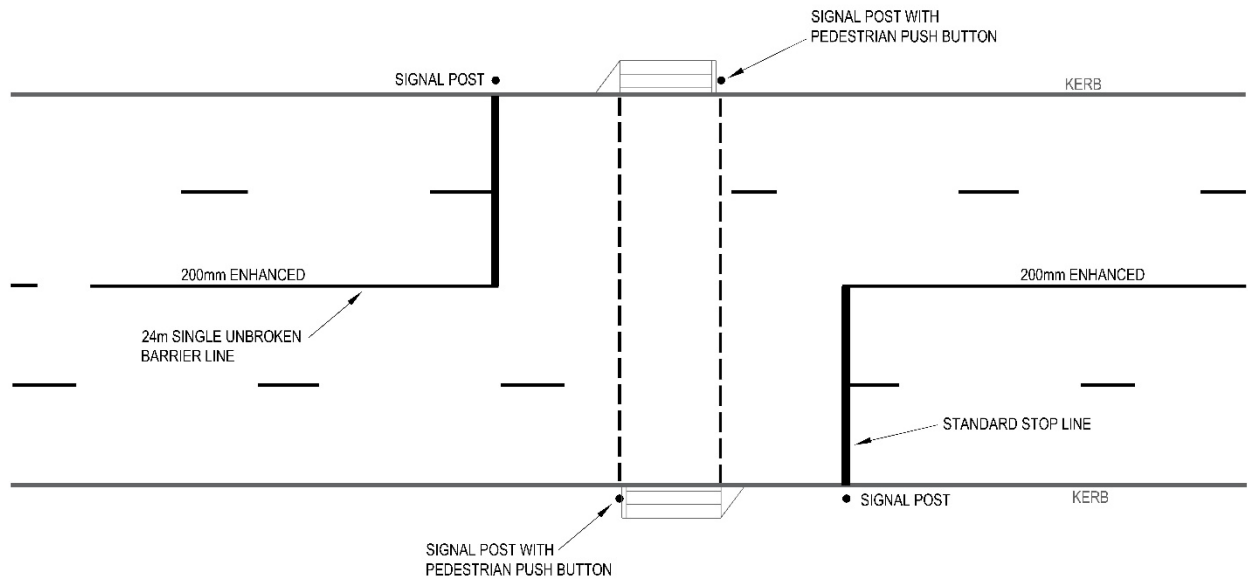

3.3.25 SCHOOL ZONES

References: ARR Rule 23; Speed Limit Guidelines for South Australia

A zigzag marking is used to increase driver awareness of a school zone. It is placed in advance of a School Zone sign, subject to site conditions.

Zigzag pavement markings shall be used at all School Zones.

Typically, the trailing end of the zigzag marking is placed at the school zone sign with the marking commencing 30 m in advance of the sign.

'SCHOOL' pavement messages may be used where visibility to the R3-SA58 School Zone sign is limited by the horizontal or vertical alignment of the road. This message may supplement the W6-SA106 School Zone warning sign(s) in which case the message shall be adjacent the sign, **see 3.3.25.3.**

Other markings, such as speed limits, coloured patches or symbols shall not be used.

The zigzag markings must be as shown in 2.1.11, unless otherwise indicated in the following examples.

3.3.25.1 Zigzag marking lateral position

NOTE: For dimensions of zigzag marking **see 2.1.11**

a) Parking prohibited at all times.

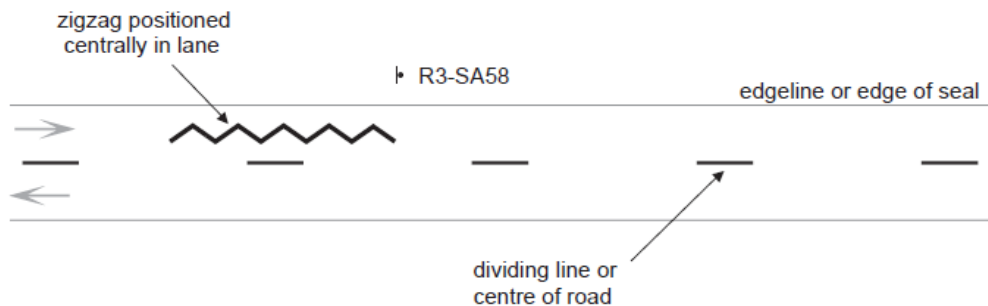

b) Adjacent indented parking lane and full-time bicycle lane.

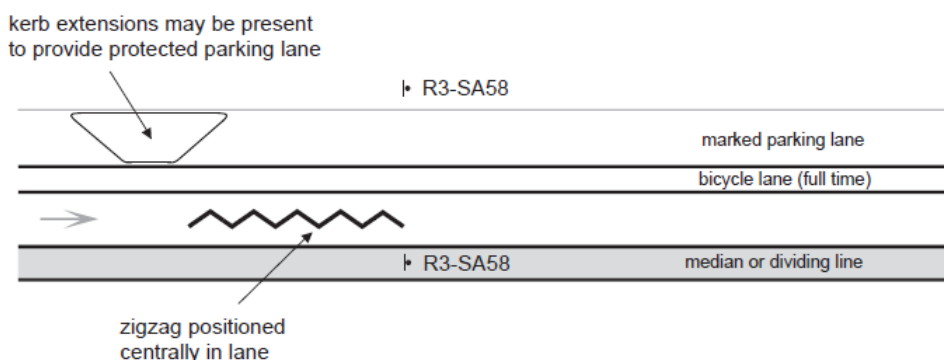

SCHOOL ZONES (continued)

c) Adjacent wide kerbside lane.

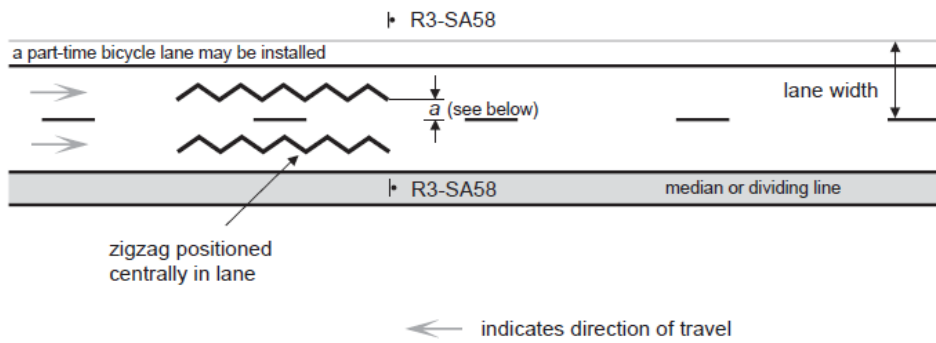

d) Part time parking restriction.

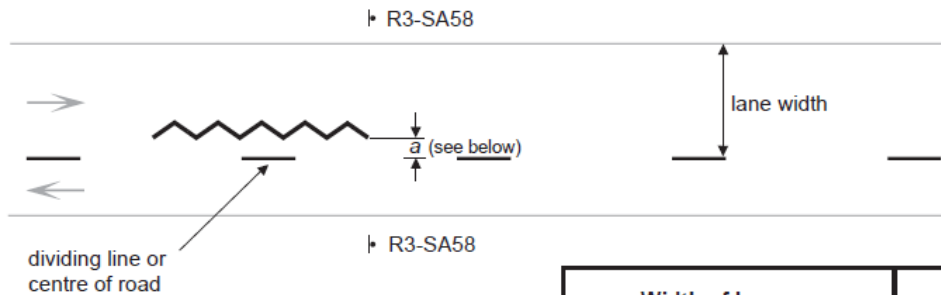

Width of lane	Value of a
less than or equal to 4.0m	0.2m
between 4.0m to 6.0m	0.6m
greater than 6.0m	1.2m

3.3.25.2 Basic school zone

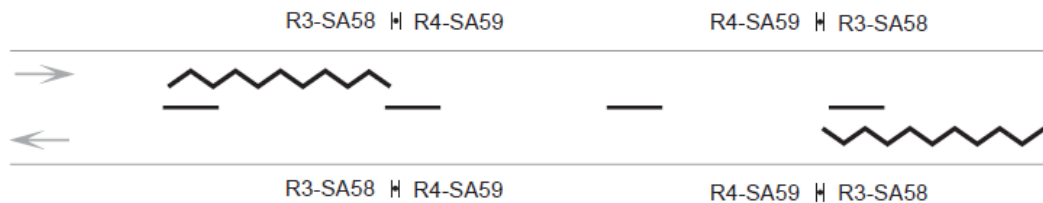

SCHOOL ZONES (continued)

3.3.25.3 Curved alignment

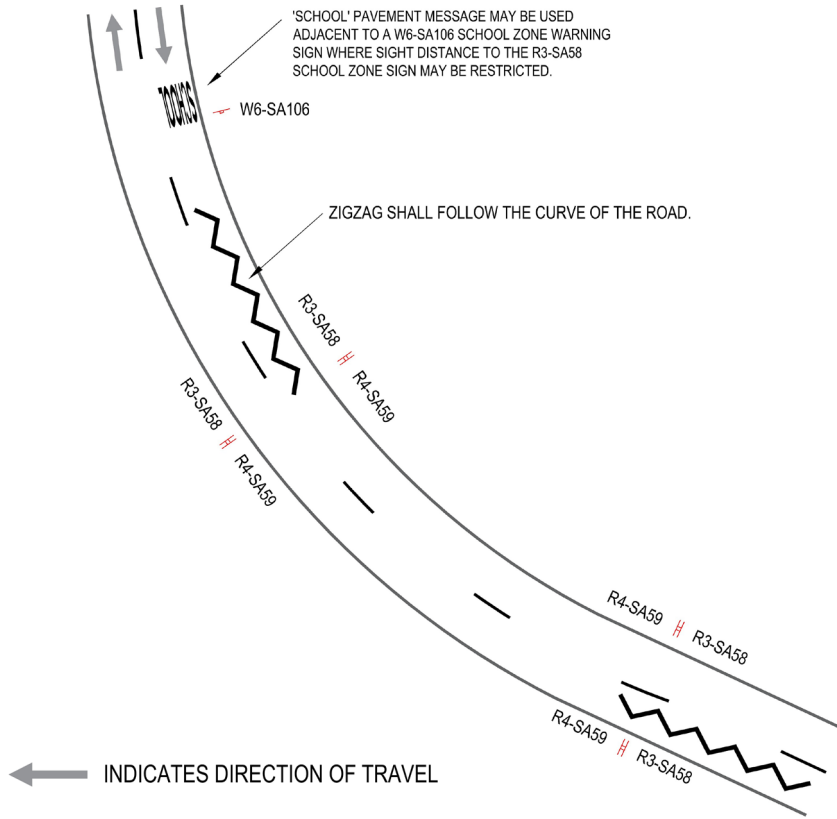

3.3.25.4 At intersections and Emu crossings

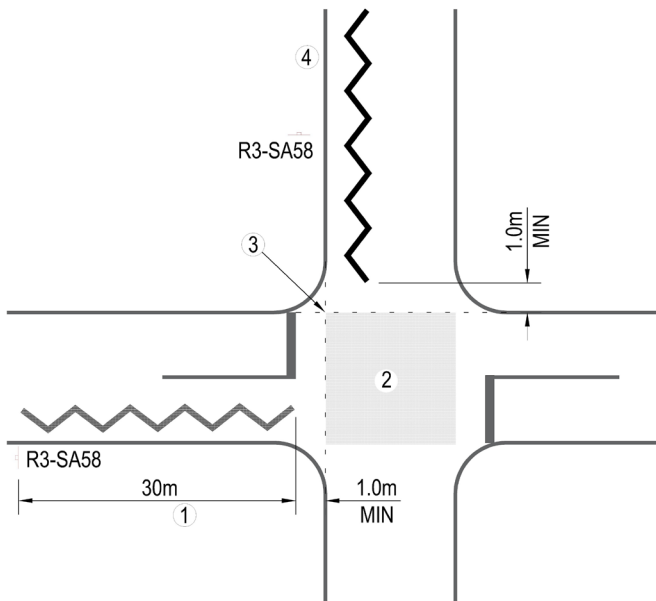

SCHOOL ZONES (continued)

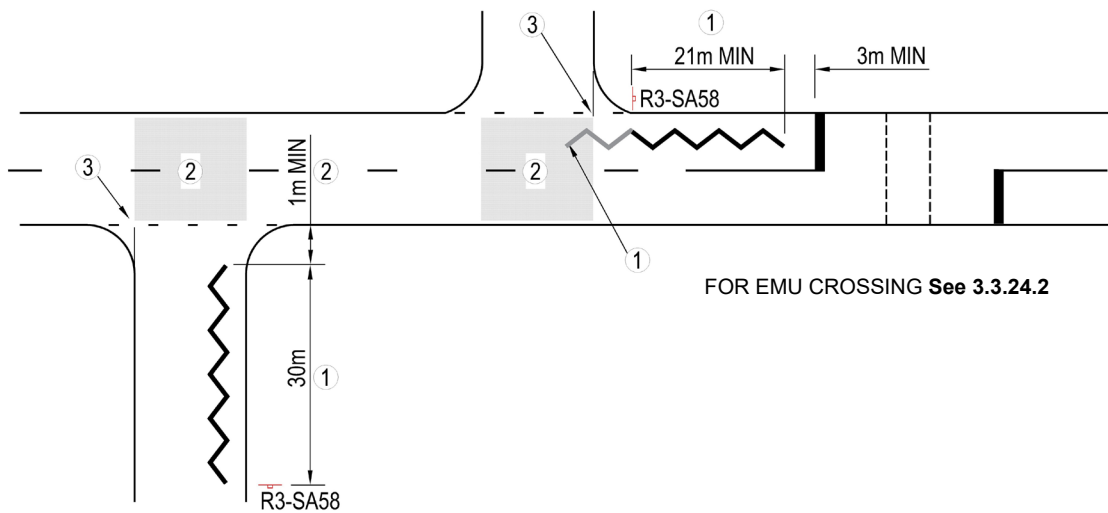

NOTES:

1. Zigzag marking should be 30 m long but may be reduced to a minimum of 21 m.
2. Zigzag markings must not extend into an intersection. It must be clear of the prolongation of the kerb or edge of road by at least 1 m.
3. Prolongation of kerb or edge of road
4. Zigzag marking may retain its length by extending past the School Zone sign i.e. where sign installation may be restricted due to driveways

3.3.26 BUS FACILITIES

Bus facilities on roads include part time Bus Lanes, full time Bus Lanes and Bus Only areas. All three are pavement marked differently. Where distinctive coloured pavement is required, use Signal Red R13.

General requirements:

- For Bus Lane widths on an urban arterial road agreement shall be sought from Public Transport Services, DIT.
- At the start of a Bus Lane where road users are required to diverge to avoid entering the lane, a continuity line transition shall be provided.
- Full time Bus Lanes shall have a continuous lane line.
- Part time Bus Lanes shall have a special purpose broken lane line.
- BUS LANE AHEAD pavement messages placed in advance of the continuity line transition are preferred for both full and part time Bus Lanes.
- BUS LANE pavement messages must be placed at the start of both full and part time Bus Lanes after intersections and at intervals not exceeding 200 m.
- BL pavement messages shall not be used.
- Continuity line transitions lines shall be:
 - Not less than 35 m where traffic is not required to merge with another lane of traffic to avoid entering the Bus Lane.
 - Full merging transition length where traffic is required to merge with another lane.
- Pavement messages need not be in lateral alignment with Bus Lane signs.
- Red pavement colouring in a lane or part of a lane shall only be used with a BUS ONLY pavement message. Red shall not be used for any other purpose.

3.3.26.1 Placing of lane messages

Reference: AS 1742.12

Bus Lane Ahead

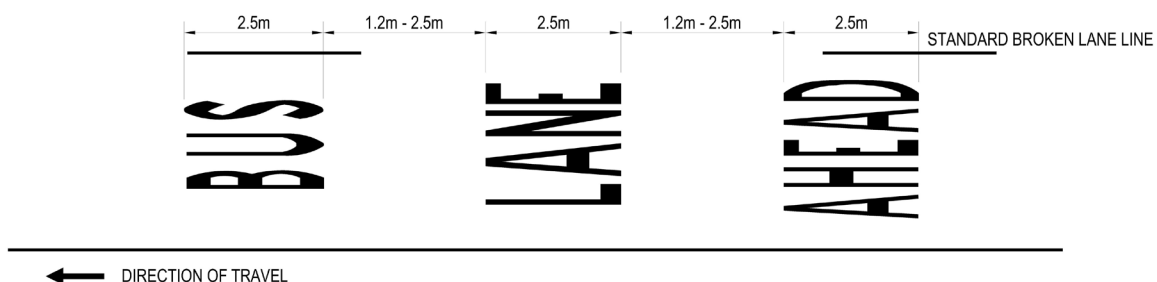

BUS FACILITIES (continued)

Part Time Bus Lane

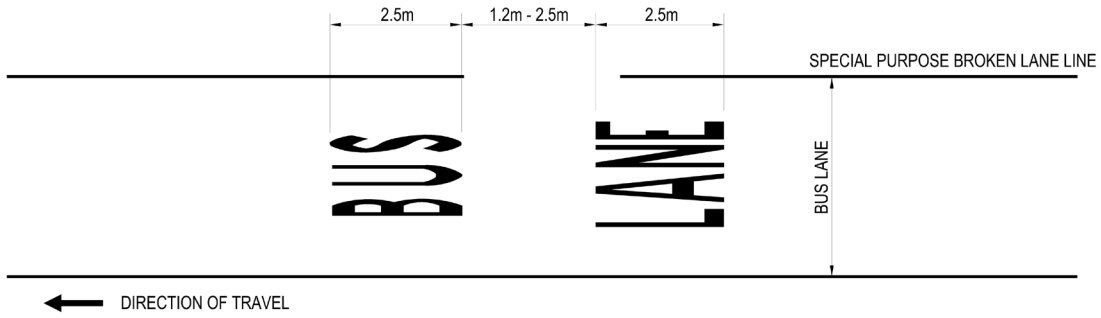

Full Time Bus Lane

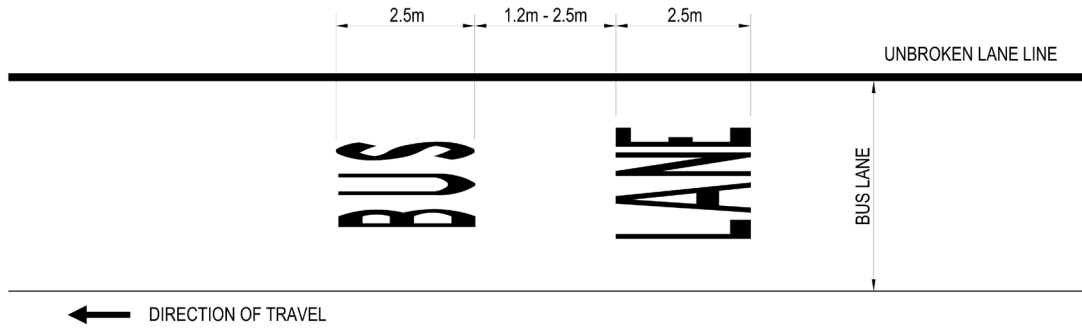

Bus Only

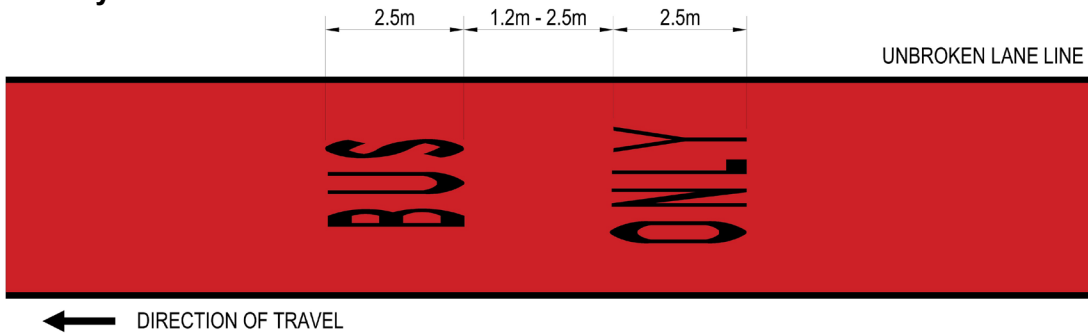

Layout

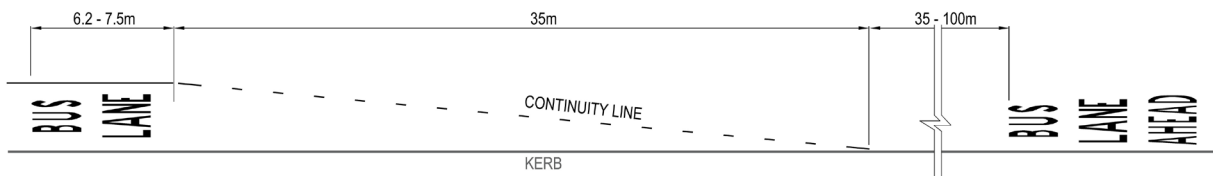

BUS FACILITIES (continued)

3.3.26.2 Full-time / Part-time bus lanes

References: ARR Rules 154, 158, 187; AS 1742.12 Section 6

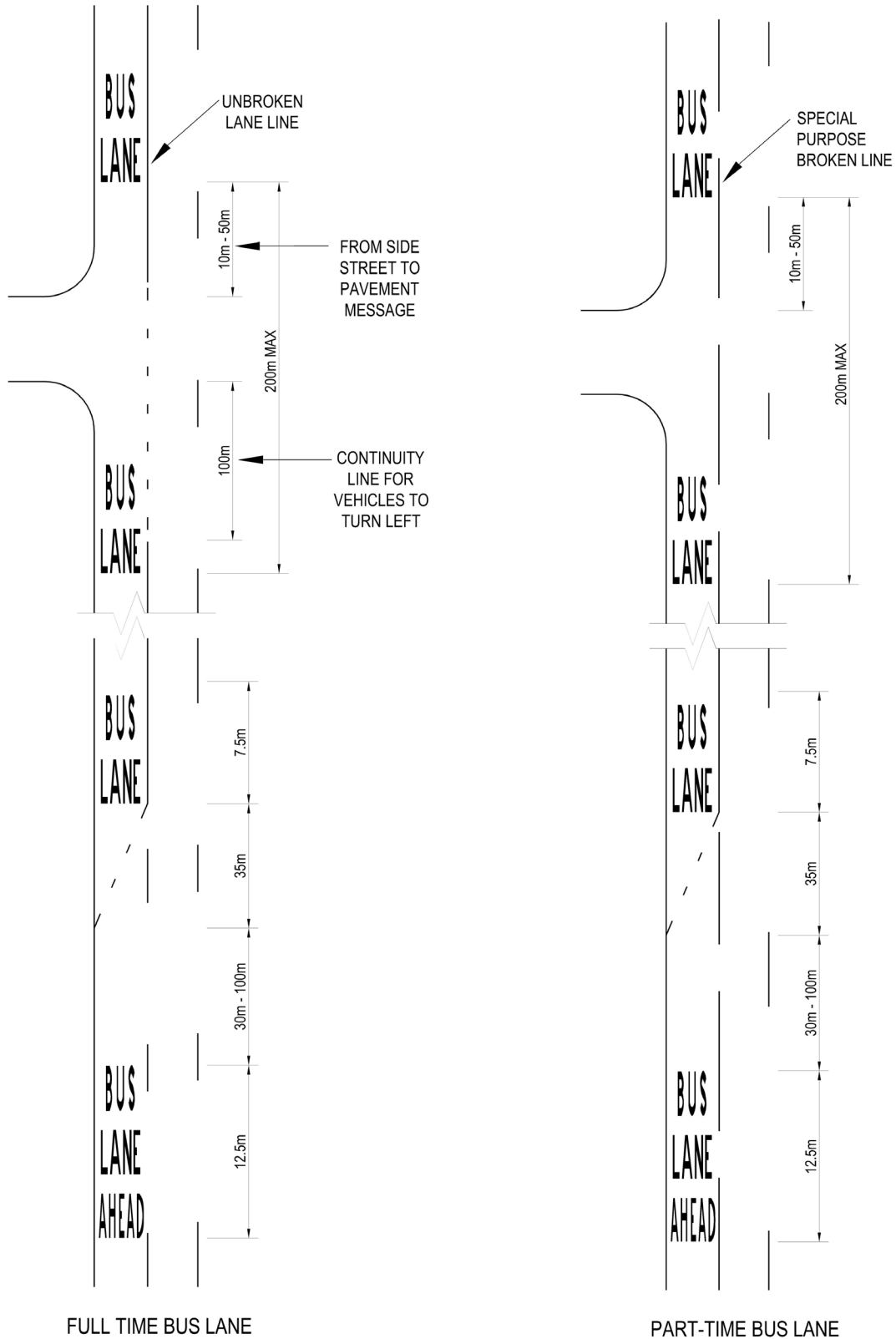

BUS FACILITIES (continued)

3.3.26.3 Parking bays in Bus Lanes

Reference: AS 1742.12

Parking bays should not normally be marked in part-time bus lanes. However, when they are required, they should be marked with “T” and “L” markings.



3.3.26.4 Bus Only

Reference: Road Traffic Act (Road Rules Ancillary and Misc. Provisions), Regulations 2014: Part 2 reg 13

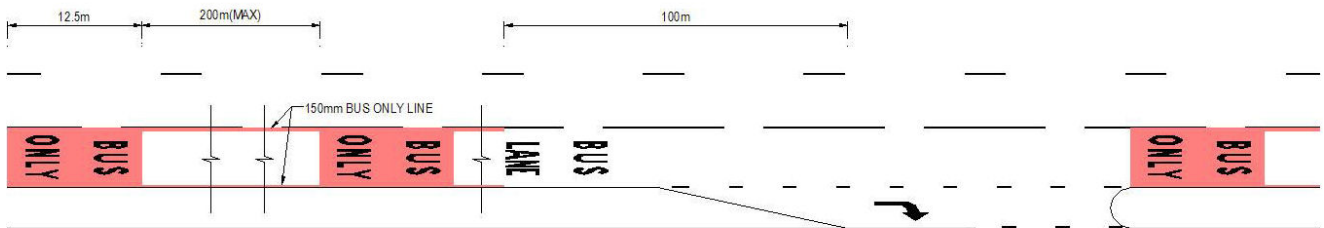
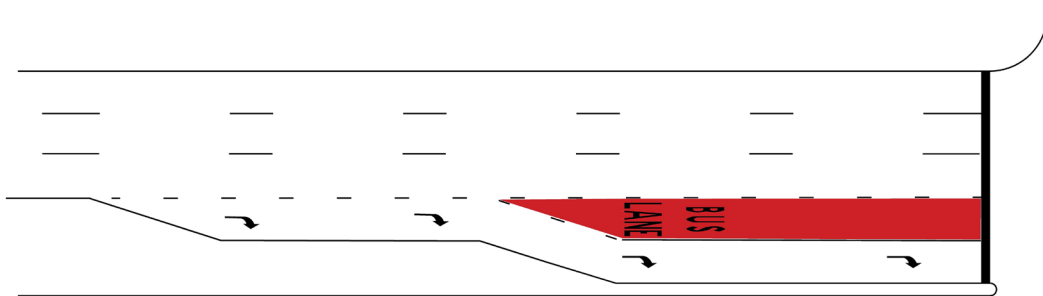

BUS FACILITIES (continued)

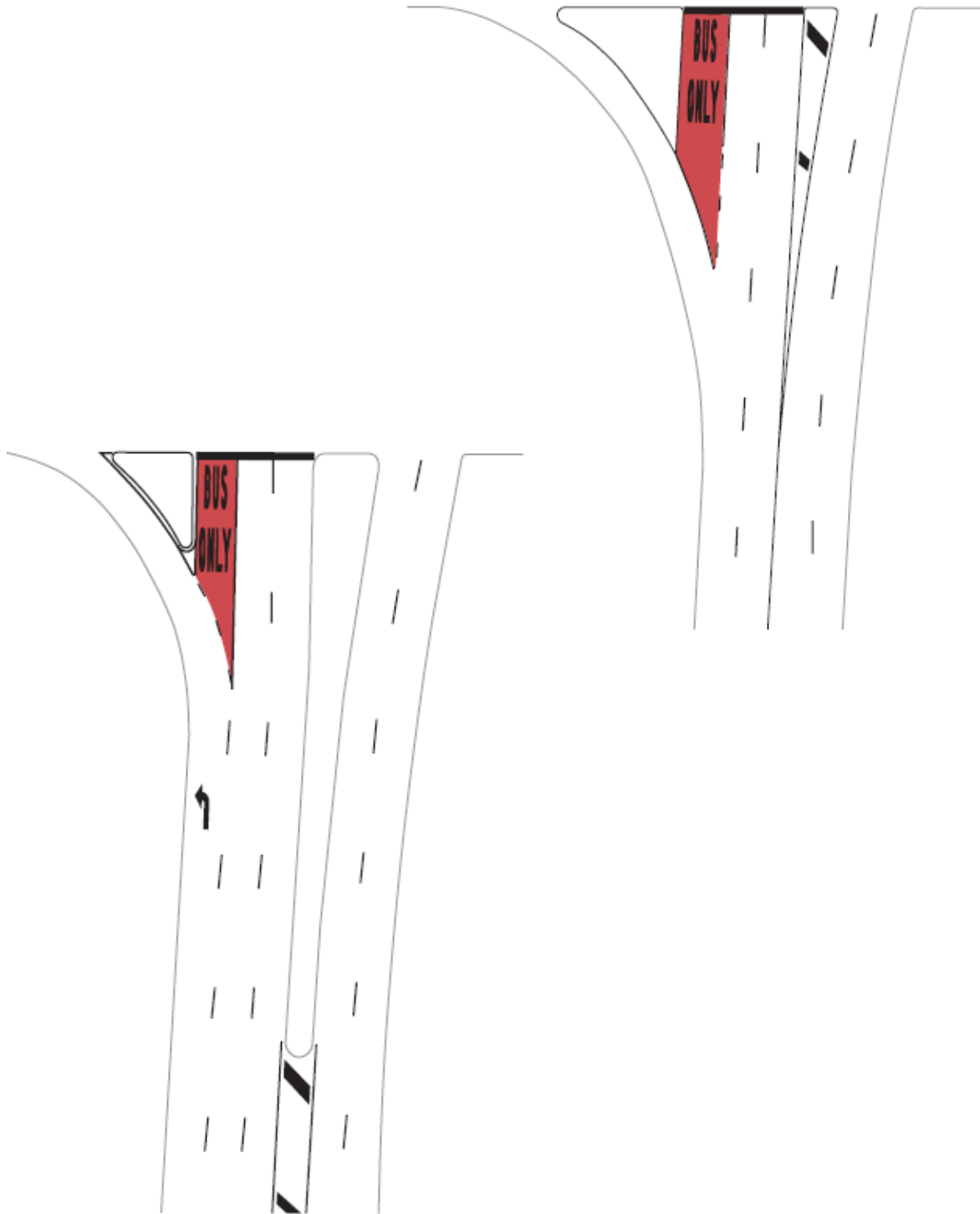

3.3.27 DISTINCTIVE COLOURED PAVEMENT BICYCLE FACILITIES

References: AS 1742.9 Clause 2.3.3; OI 9.3

Distinctive green pavement (Emerald Green G13) can be used in areas of 'potential conflict' e.g. between motor vehicle and bicycle traffic, including those segments of on-road bicycle lane where motor vehicle traffic is legally permitted to cross double continuity lines. Areas of conflict between cyclists and pedestrians may include areas where parallel parking exists with high parking turn-over.

Distinctive coloured pavements may also be applied to:

- bicycle storage areas at signalised intersections
- contra-flow bicycle lanes
- contra-flow bicycle storage areas
- separated bicycle lanes
- bicycle lanes located next to or between motor vehicle lanes where desirable minimum motor vehicle and bicycle lane width requirements are not achieved
- bicycle lanes on a left hand curve where vehicles routinely cut into the bicycle lane or
- bicycle lane located adjacent on-street parallel parking where the likelihood of car 'dooring' may occur
- **turn right into a side road over 3 lanes or more**
- where a bicycle path crosses a slip lane (between the crosswalk lines). Refer *GRD Part 4 Fig A.14*.

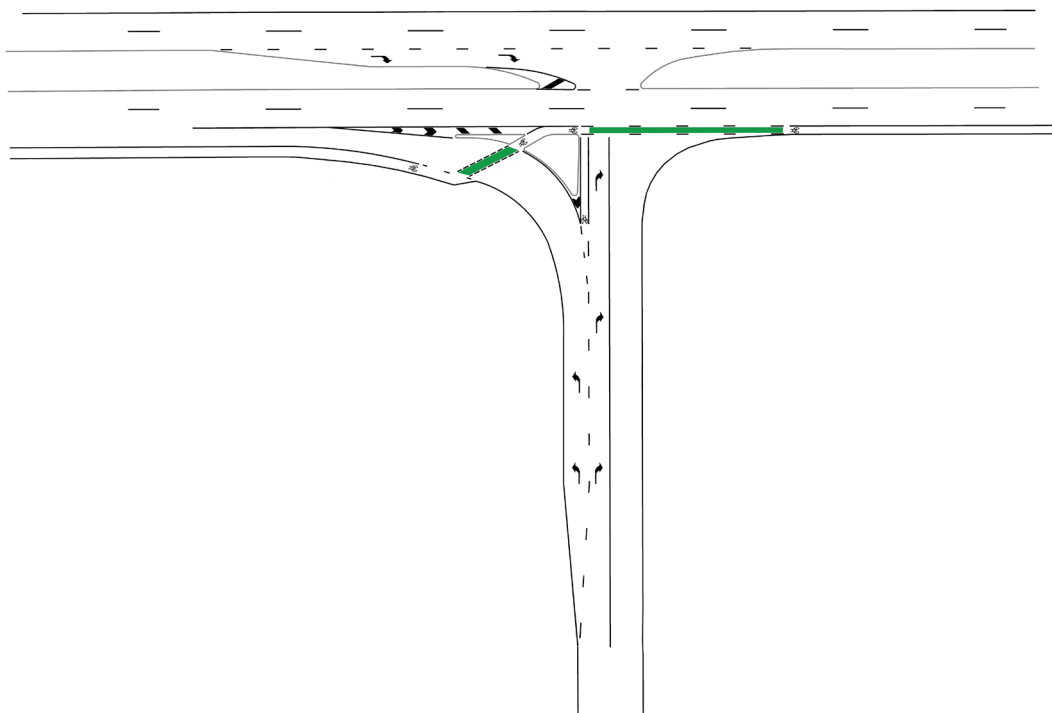

DISTINCTIVE COLOURED PAVEMENT BICYCLE FACILITIES (continued)

3.3.27.1 Left turn acceleration and deceleration lanes

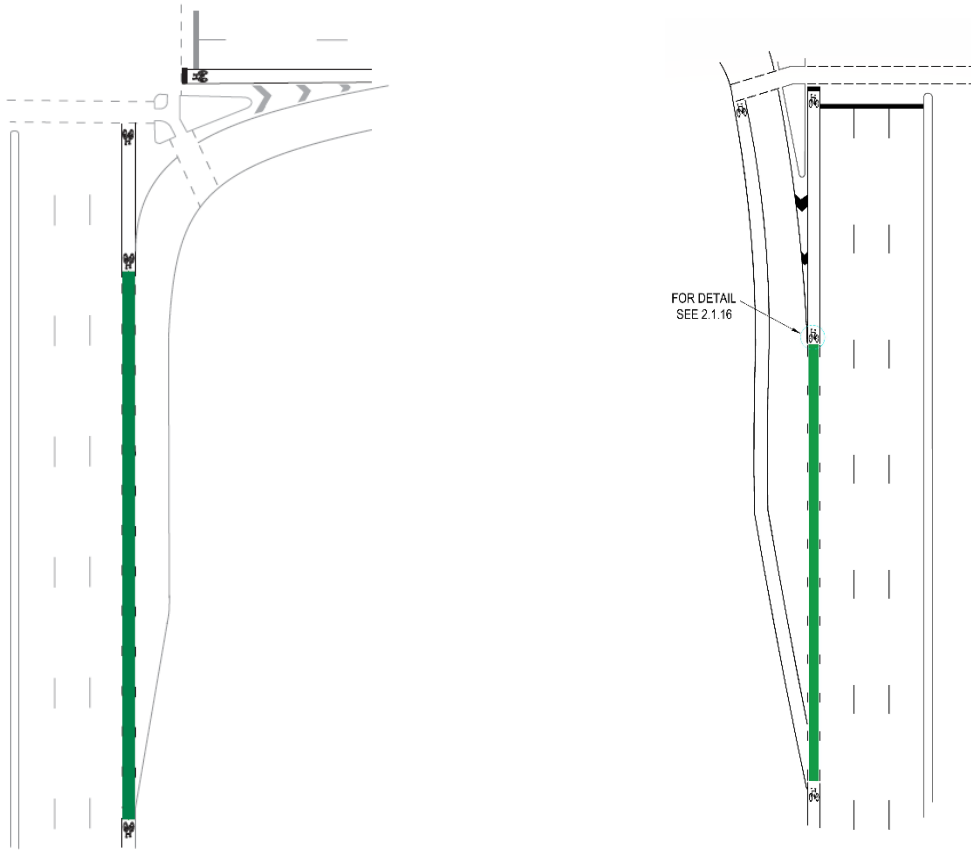

3.3.27.2 High angle left turn lane

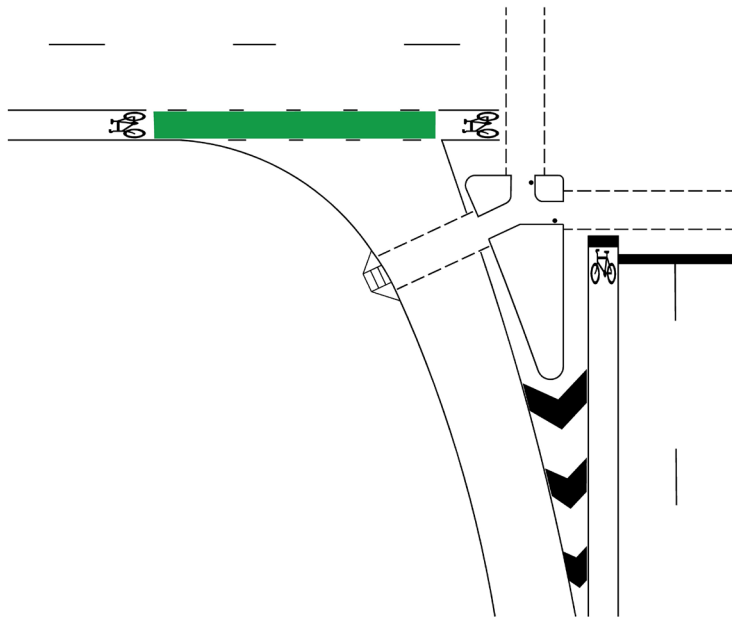

DISTINCTIVE COLOURED PAVEMENT BICYCLE FACILITIES (continued)

3.3.27.3 Minor side road junction

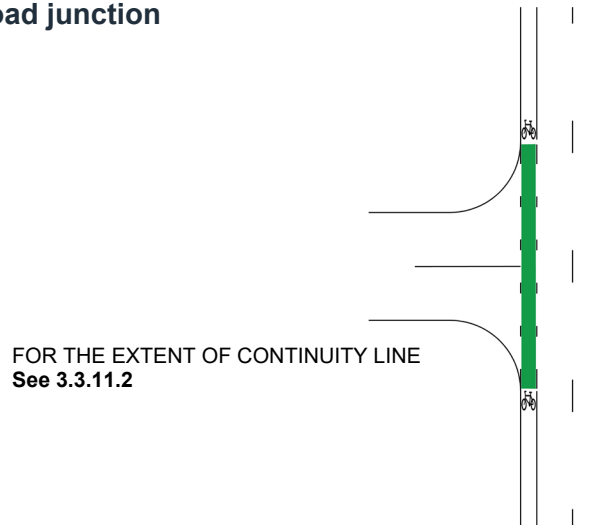

NOTE: On DIT roads, this treatment should only be used at locations with a crash history

3.3.27.4 Bicycle storage area

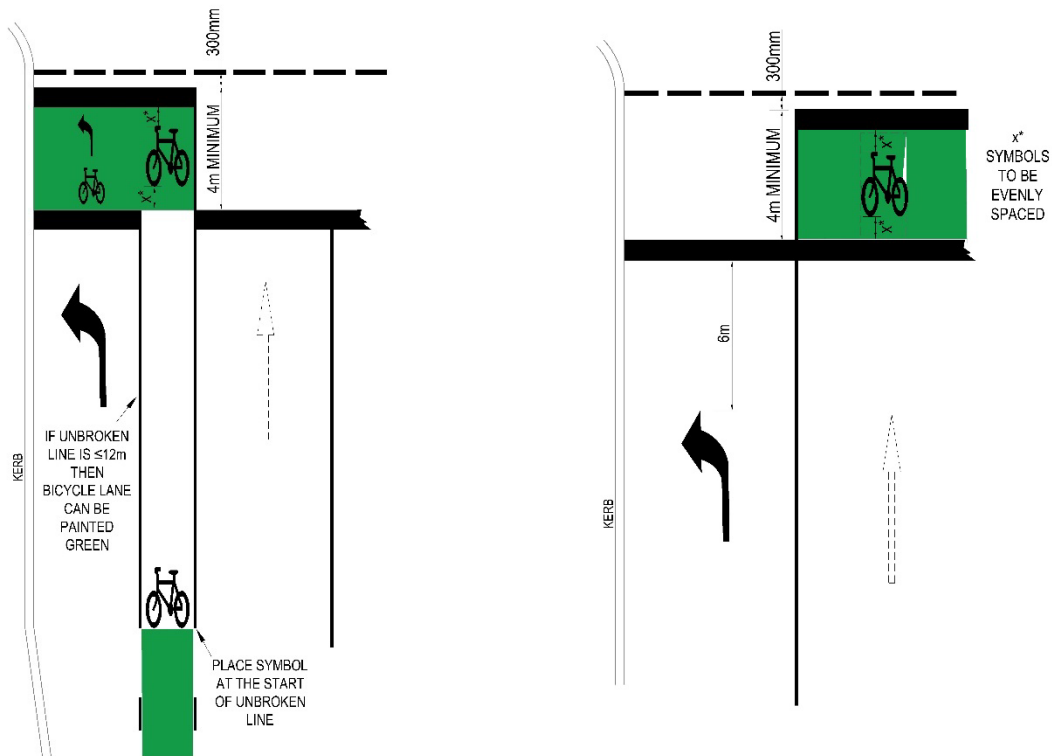

WITH A BICYCLE LANE

WITHOUT A BICYCLE LANE

NOTES:

1. For bicycle logo details see 2.1.8.3.
2. Green coloured pavement surface shall be Emerald Green G13.
3. Bike box must not interfere with phasing

3.3.28 OTHER BICYCLE FACILITIES

3.3.28.1 Indented hook turn

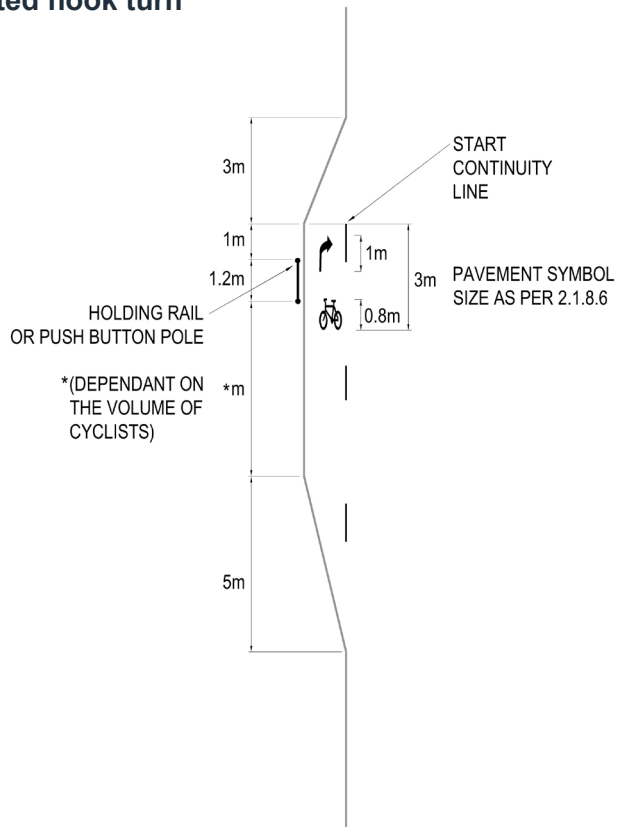

3.3.28.2 Detector loop

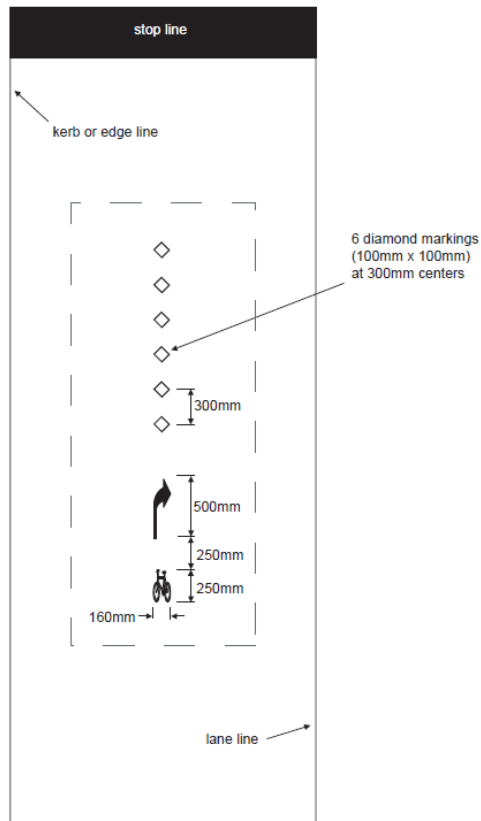

3.4 RURAL TREATMENTS

This section details the pavement marking differences between the general or urban treatments and those in rural areas. In cases other than those listed below, treatments should be the same for both built up urban and rural situations.

3.4.1 DIVIDED RURAL ROADS

Although most of the design details for treatments between intersections in this section relate to undivided roads, the same principles, with the exception of dividing lines, should be applied for divided roads.

3.4.2 MULTI-LANE UNDIVIDED RURAL ROADS

References: GRD Part 3; GRD Part 4A

Multi-lane undivided roads shall not be used in high-speed rural environments with the exception of specific treatments such as overtaking lanes, channelised right turn treatment (CHR) and channelised left turn treatment (CHL).

3.4.3 DIVIDING LINES ON RURAL ROADS

References: ARR Rules 132, 134; AS 1742.2 Section 5

Dividing lines shall be installed in accordance with AS 1742.2. The use of single unbroken barrier lines as dividing lines are generally not recommended in high speed rural environments. Although such lines prohibit certain crossing movements, including U-turns, they do not prohibit entering or leaving the road (**see 3.4.4**).

Any assessment for the need for dividing lines needs to consider the following:

- All rural 'arterial' roads shall be provided with dividing lines and should be augmented with RRPMs.
- All rural 'collector' roads should be provided with dividing lines.
- Local rural roads may be provided with dividing lines. Installing dividing lines on narrow roads may have implications for parking.
- Where provided between major rural intersections dividing lines should be broken, and shall be standard width for 2 lane roads and enhanced for multi lane roads.
- Where provided on minor or local rural roads at intersections, short sections of single unbroken barrier line shall be provided. (**See 3.4.4 and 2.1.5** for details)

3.4.4 BARRIER LINES ON RURAL ROADS

A single unbroken barrier line should be used through rural townships as an alternative to double two-way barrier lines or in high-speed areas where the double barrier lines may reduce lane widths below the desirable minimum. This allows the line to be crossed by traffic entering or leaving the road. Barrier lines on high-speed rural roads shall only consist of double lines, either 'Double One-Way Barriers' or 'Double Two-Way Barriers' to create 'No Overtaking Zones' and shall be restricted to locations with either horizontal or vertical sight restrictions or both and only be determined in accordance with AS 1742.2.

BARRIER LINES ON RURAL ROADS (continued)

The barrier line installed on approaches to rural intersections (**see 2.1.5.1**) shall be single unbroken barrier line, unless the section of road has restricted overtaking sight distance (refer *AS 1742.2 Clause 5.3.3.2*) in which case double barrier line shall be used.

A 10 m single unbroken barrier line should be provided on the side road at the intersection of the main road if the width of the side road is > 12 m between TPs.

Double barrier lines, one-way or two-way, are not generally used in SA to prohibit overtaking at isolated locations except:

- at approaches to intersections. **See 2.1.5 and 2.1.18**
- Railway level crossings in accordance with *AS 1742.7*
- Overtaking lanes in accordance with this document and *OI 2.15*
- Ferry approaches

3.4.5 WIDE CENTRE LINE TREATMENTS

References: AGRD Part 3 Appendix G; Section 2.1.1.1 g for centre line treatments ≤ 1.4 m

For wide centre line treatments, the following requirements for the establishment of no-overtaking zones apply. For all other locations, refer to *AS 1742.2*.

For 110km/h design speed

- Minimum overtaking sight distance 590m
- Barrier line distance 280m
- Maximum length with no Barrier Lines 55m*
- Minimum length of Barrier Lines 165m
- Minimum distance between Barrier Lines 310m

For 120km/h design speed

- Minimum overtaking sight distance 690m
- Barrier line distance 330m
- Maximum length with no Barrier Lines 60m*
- Minimum length of Barrier Lines 180m
- Minimum distance between Barrier Lines 350m

* where a short length of road has substandard overtaking sight distance, barrier lines should not be marked e.g. short sag (floodway) on an otherwise level road.

3.4.6 LANE LINES ON RURAL ROADS

Lane lines i.e. lines dividing lanes of the same direction traffic, must be provided on roads where vehicles are expected to travel in more than one line of traffic.

Lanes should not be marked on a rural road where it would result in lane widths of less than 3.1 m. Restricted access routes may require greater lane widths.

Lane lines are normally standard broken. However, unbroken lane lines may be used between exclusive through and exclusive turn lanes on approaches to intersections.

LANE LINES ON RURAL ROADS (continued)

Lane lines on rural roads should be continued through minor road intersections.

All multi-lane divided rural roads shall be provided with enhanced edge lines and outlines.

Multi lane divided rural road

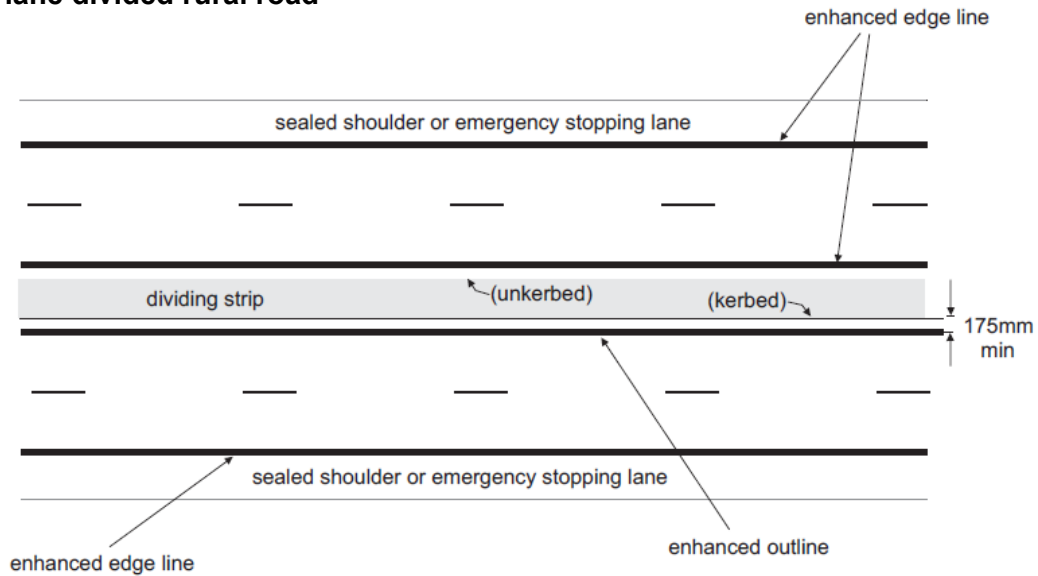

Reflective pavement dots (RPDs) can be installed on lane lines where roads are prone to fog or for lane disciplinary problems. **Also see 3.3.21.6.**

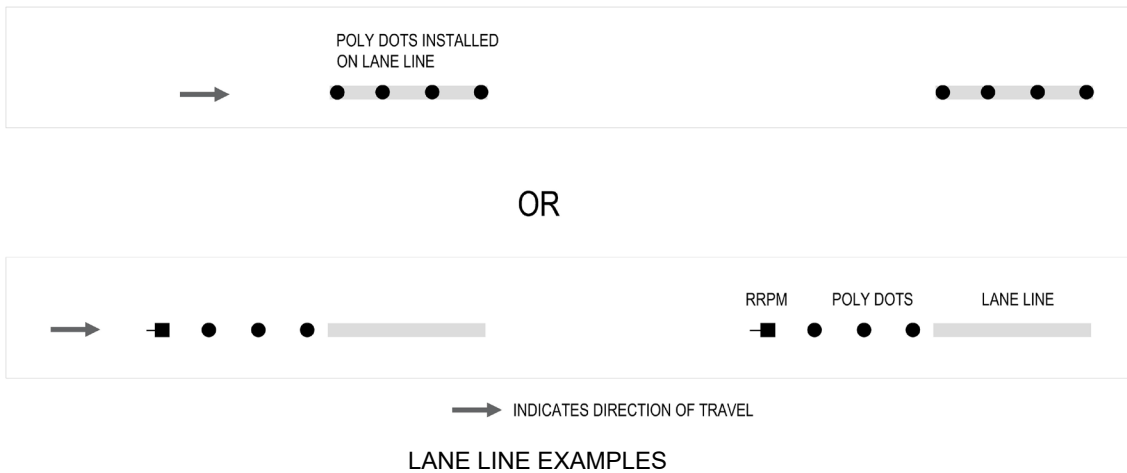

3.4.7 EDGE LINES ON RURAL ROADS

References: AS 1742.2 Section 4; GRD Part 3

Edge lines provide a clear definition of the lane both day and night and discourage traffic from travelling on shoulders.

Practices regarding lane and sealed shoulder widths including the issues relating to pavement depth, should be considered before providing an edge line.

- **3.4.7.1** and **3.4.7.2** show best practice in regard to installing edge lines.
- **3.4.7.3** and **3.4.7.4** indicates a required treatment.

EDGE LINES ON RURAL ROADS (continued)

3.4.7.1 Narrow rural two-lane two-way road (sealed width ≥ 5.5 m, < 6.8 m)

Reference: AS 1742.2 Section 4

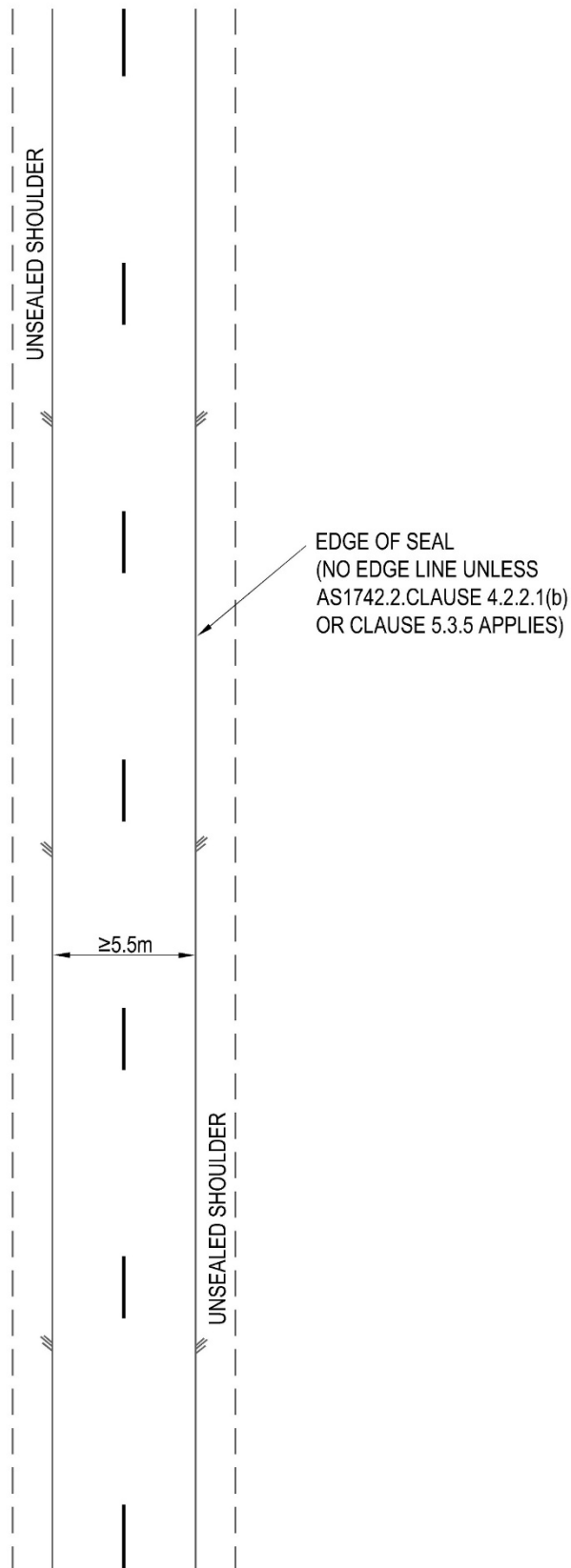

EDGE LINES ON RURAL ROADS (continued)

3.4.7.2 Standard rural two-lane two-way road (sealed width ≥ 6.8 m)

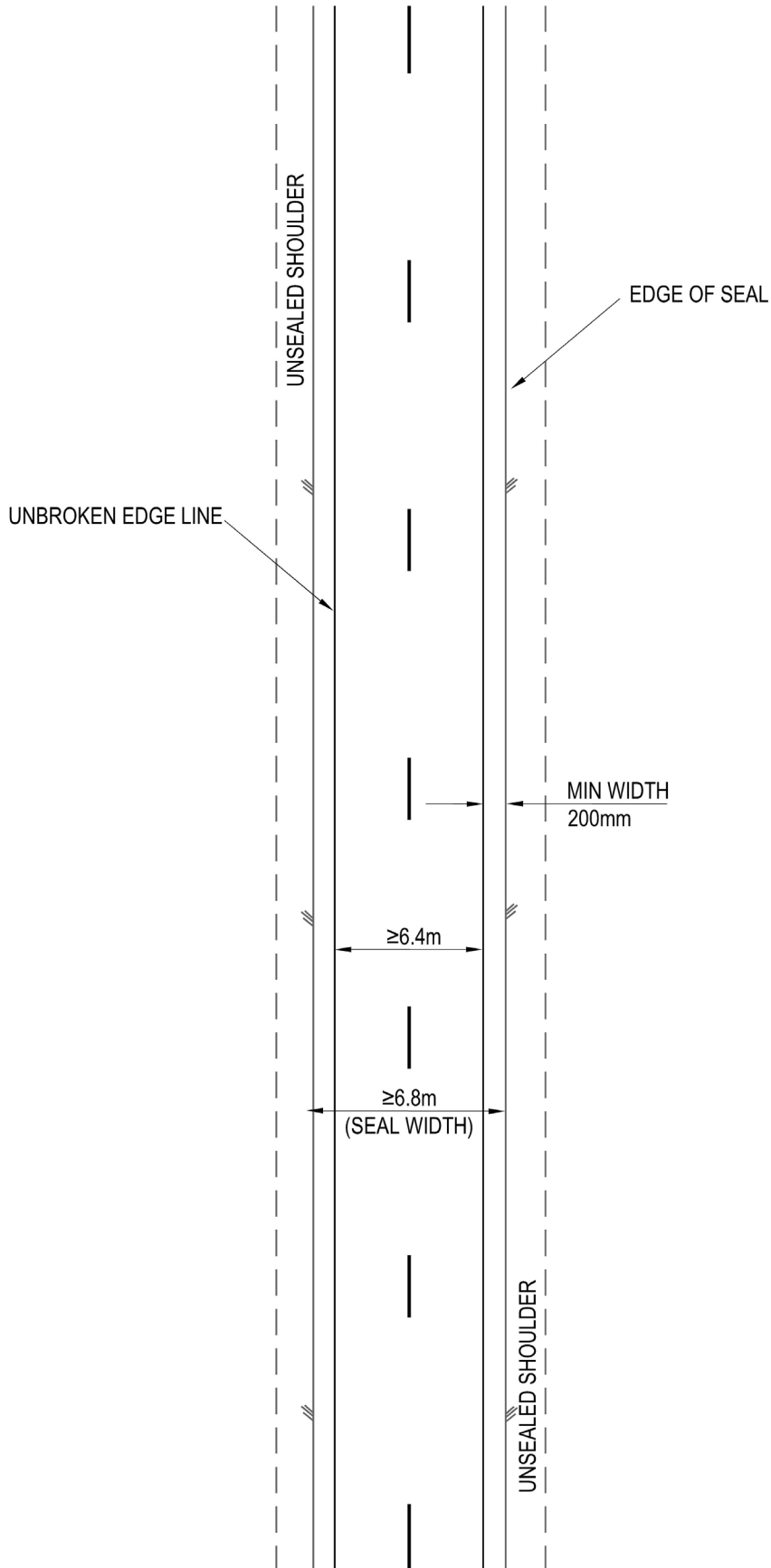

EDGE LINES ON RURAL ROADS (continued)

3.4.7.3 Wide shoulder rural two-lane two-way road (sealed shoulder width ≥ 0.5 m)

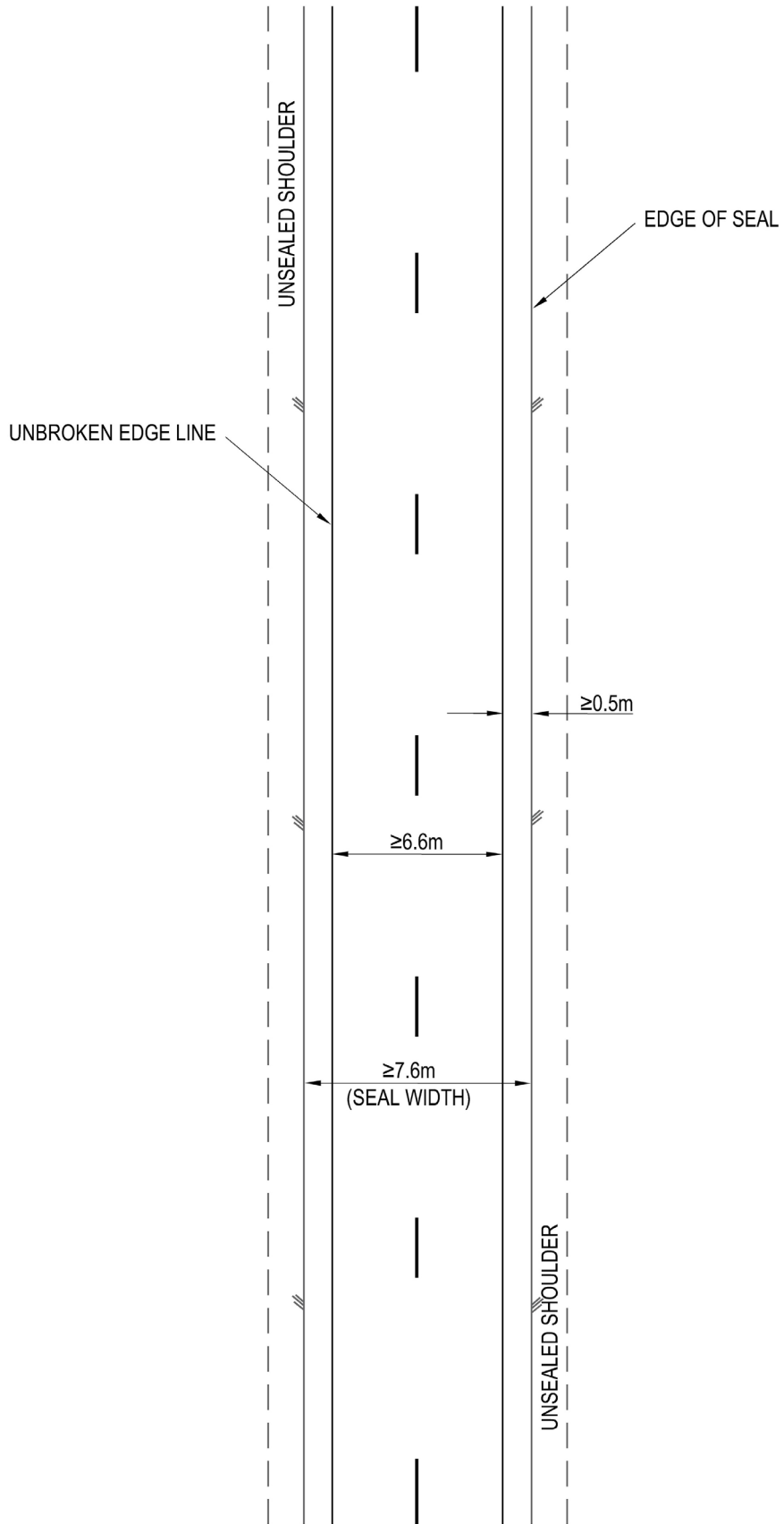

EDGE LINES ON RURAL ROADS (continued)

3.4.7.4 Multi-lane divided road (sealed shoulder width > 0.5 m)

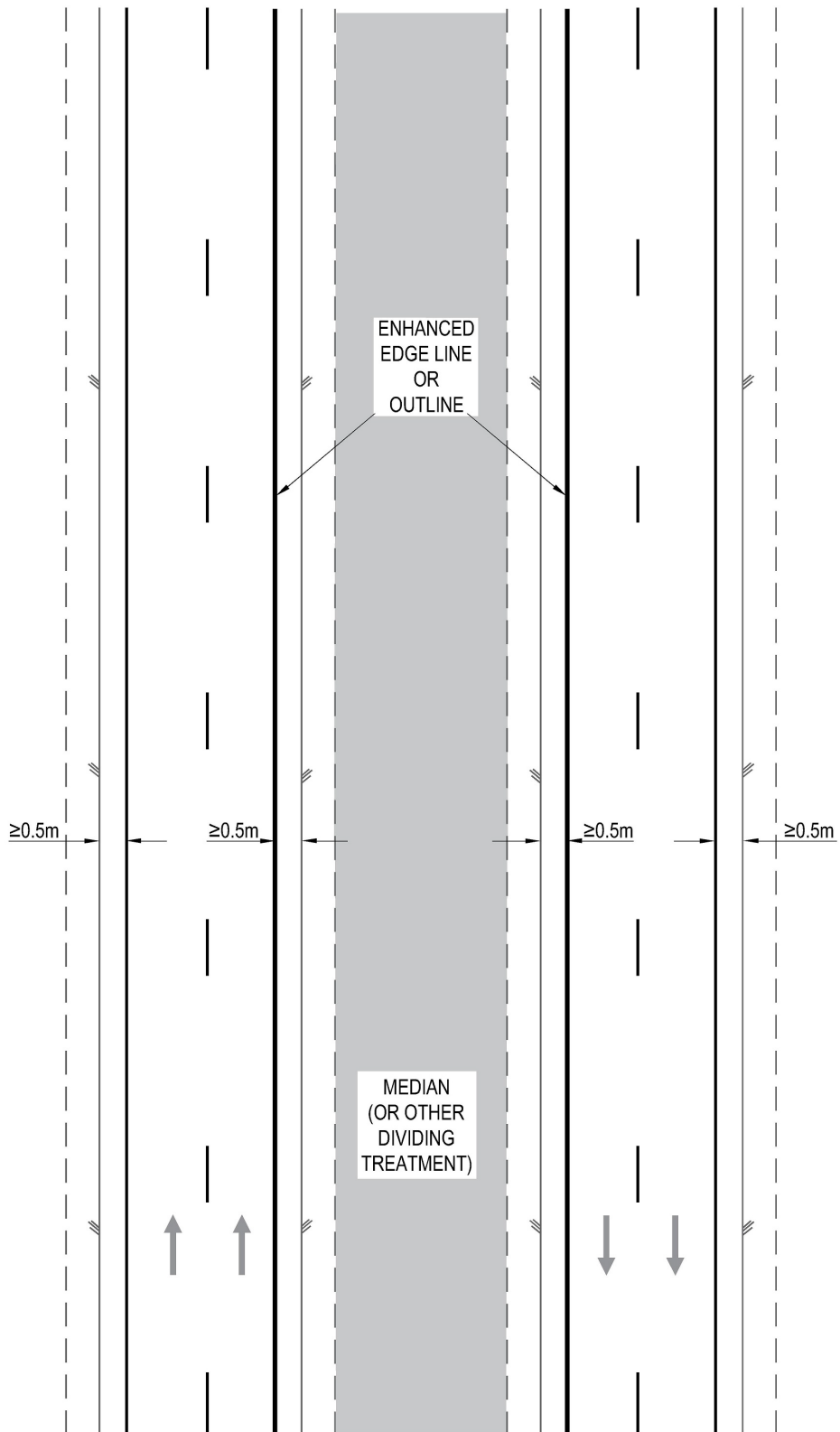

← INDICATES DIRECTION OF TRAVEL

EDGE LINES ON RURAL ROADS (continued)

3.4.7.5 Multi-lane divided road (interchange)

On the following roads the edge line shall be enhanced: **(See 2.1.1.4b)**

- Dukes Highway
- Sturt Highway
- Riddoch Highway
- Augusta Highway
- Pt Wakefield Highway
- Princes Highway
(Murray Bridge to Taillem Bend)
- Expressway

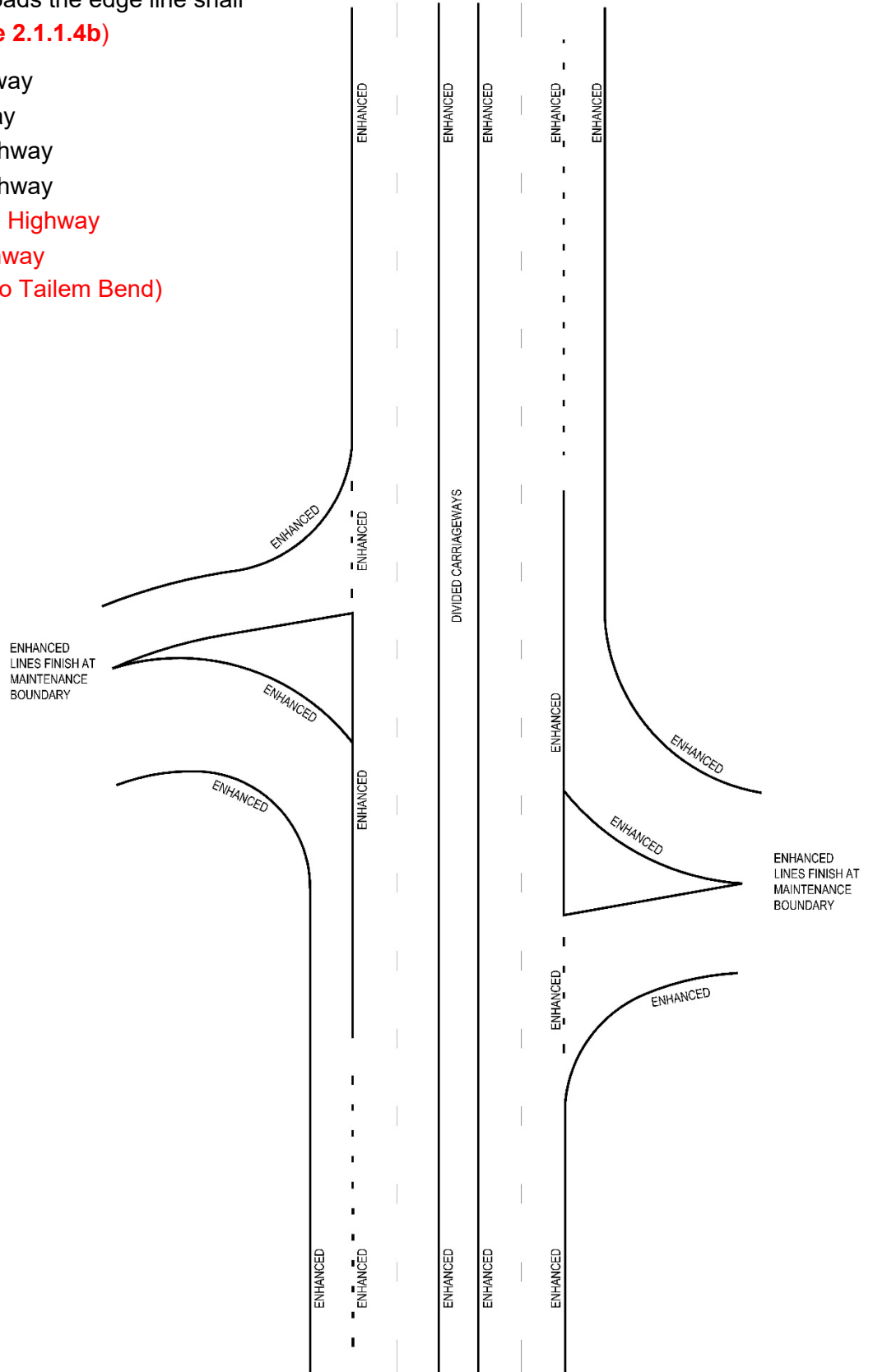

3.4.8 OVERTAKING LANE TREATMENTS

References: AS 1742.2 Section 2; GRD Part 3; OI 2.15

More details in OI 2.15 Overtaking Lanes.

3.4.8.1 Overtaking lane – diverge

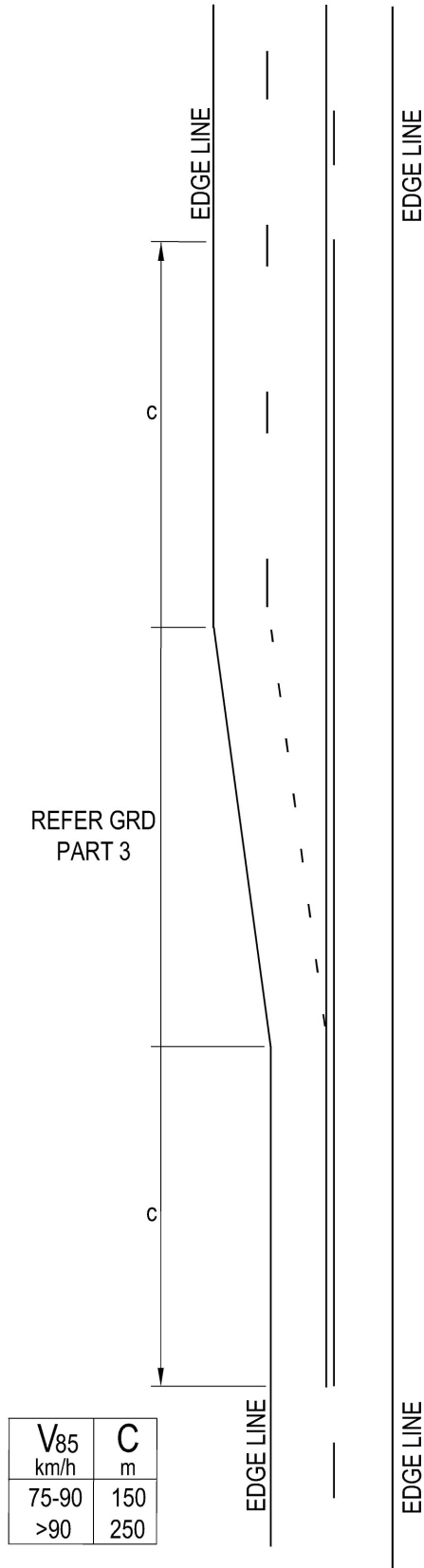

OVERTAKING LANE TREATMENTS (continued)

3.4.8.2 Lane Reduction – merge

Also refer to *OI 2.27* for right lane end merge treatment at end of auxiliary lane at seagull intersection.

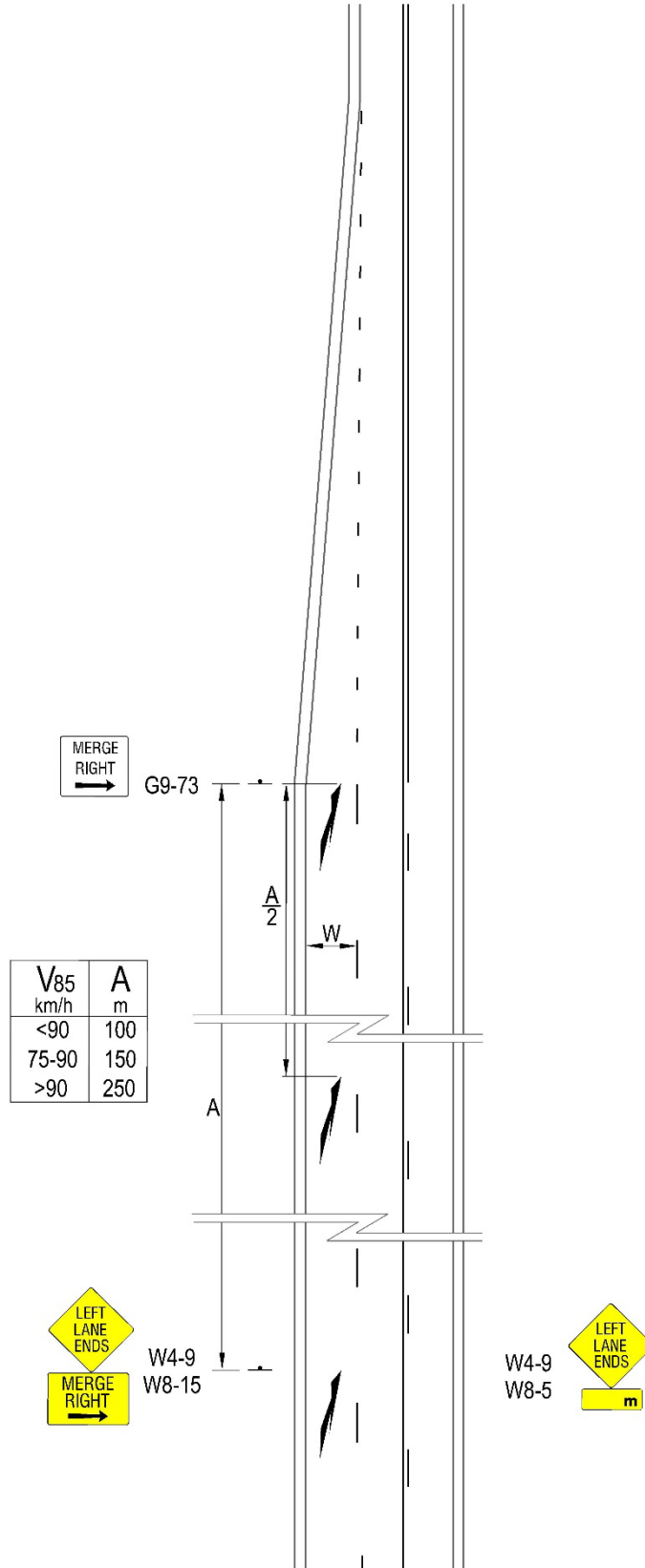

3.4.9 SLOW VEHICLE TURNOUTS

References: ARR Rules 167, 168, 169; AS 1742.2 Section 4; GRD Part 3 Section 9.6; GD 1000

Slow vehicle turnouts are short sections of sealed shoulder or added lane to provide drivers of slow-moving vehicles an area to be overtaken or passed by another vehicle where constraints do not allow provision of a full overtaking or climbing lane. Located on low speed, winding or hilly two-lane two-way roads, which have limited passing opportunities, they consist of a widened unobstructed sealed shoulder and are most effective if used in a series along a section of road.

Turnouts should be located where drivers of slow moving vehicles believe their use will not result in undue delay. Turnouts should not be interspersed with overtaking or climbing lanes.

Drivers should have a clear view of the entire turnout to determine whether it is available for use and to anticipate the movement of any other vehicles which may be exiting. Experience suggests that turnouts which cannot be seen for some distance by approaching drivers are less likely to be used.

No Parking or No Stopping?

If the driver of the slow moving vehicle were to stop in the slow vehicle turnout to allow multiple vehicles to pass and No Stopping signs and/or yellow edge lines were installed, the driver could be committing an offense under *ARR Rule 167* and *ARR Rule 169* respectively. Therefore, **No Stopping signs and yellow edge lines shall not be used.**

No Parking signs shall be installed to allow drivers to stop for short periods (up to 2 minutes - refer *ARR Rule 168*).

SLOW VEHICLE TURNOUTS (continued)

References: GRD Part 3 Section 9.6; DIT Road Design Standard GD 1000 - Slow Vehicle Turnout

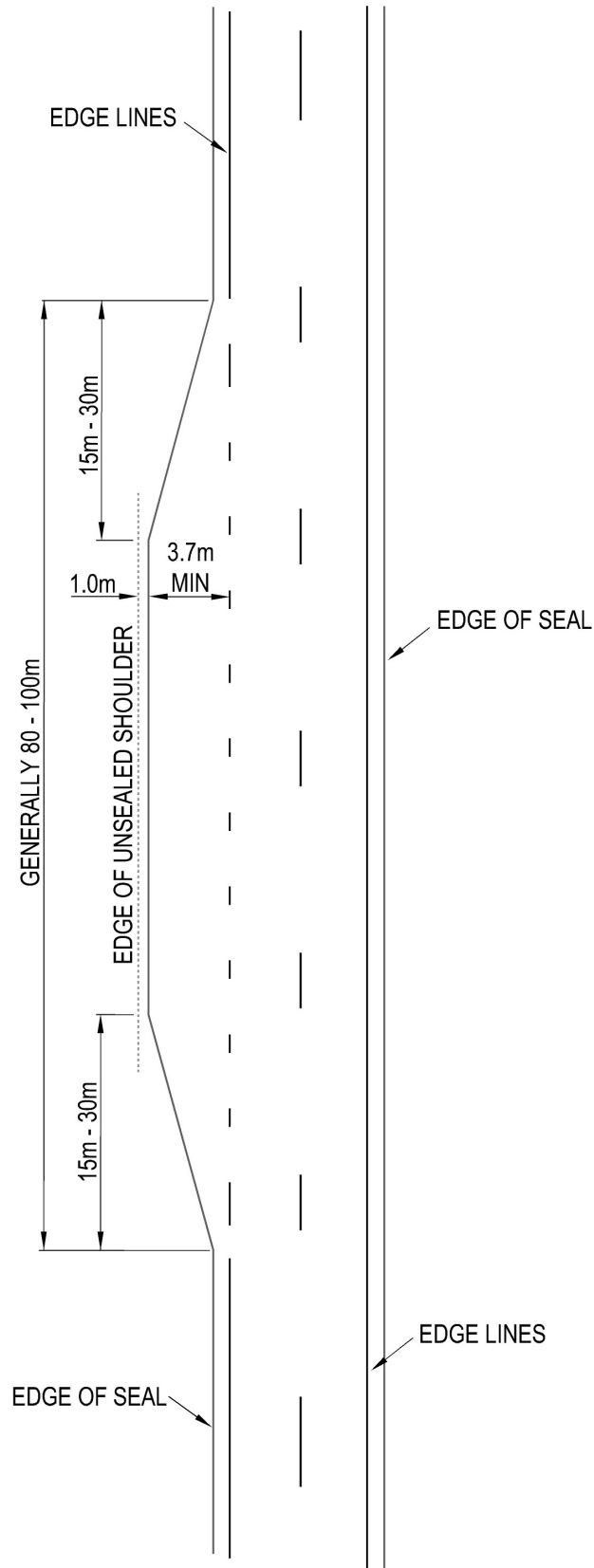

3.4.10 REST AREAS

References: ARR Rules 150 (1B), (3); OI 20.3; *Master Specification RD-GM-D1*
www.dit.sa.gov.au/?a=553233; GRD 4A; GRD 3

Rest areas may be lay-bys, truck (only) parking bays, information bays, and points of interest sites. These may be sealed or unsealed.

3.4.10.1 Roads with edge lines

NOTE: If additional reinforcement is required to prevent right turn access where an acceleration lane is provided, use 'No Entry' (R2-4) signs at rest area exit.

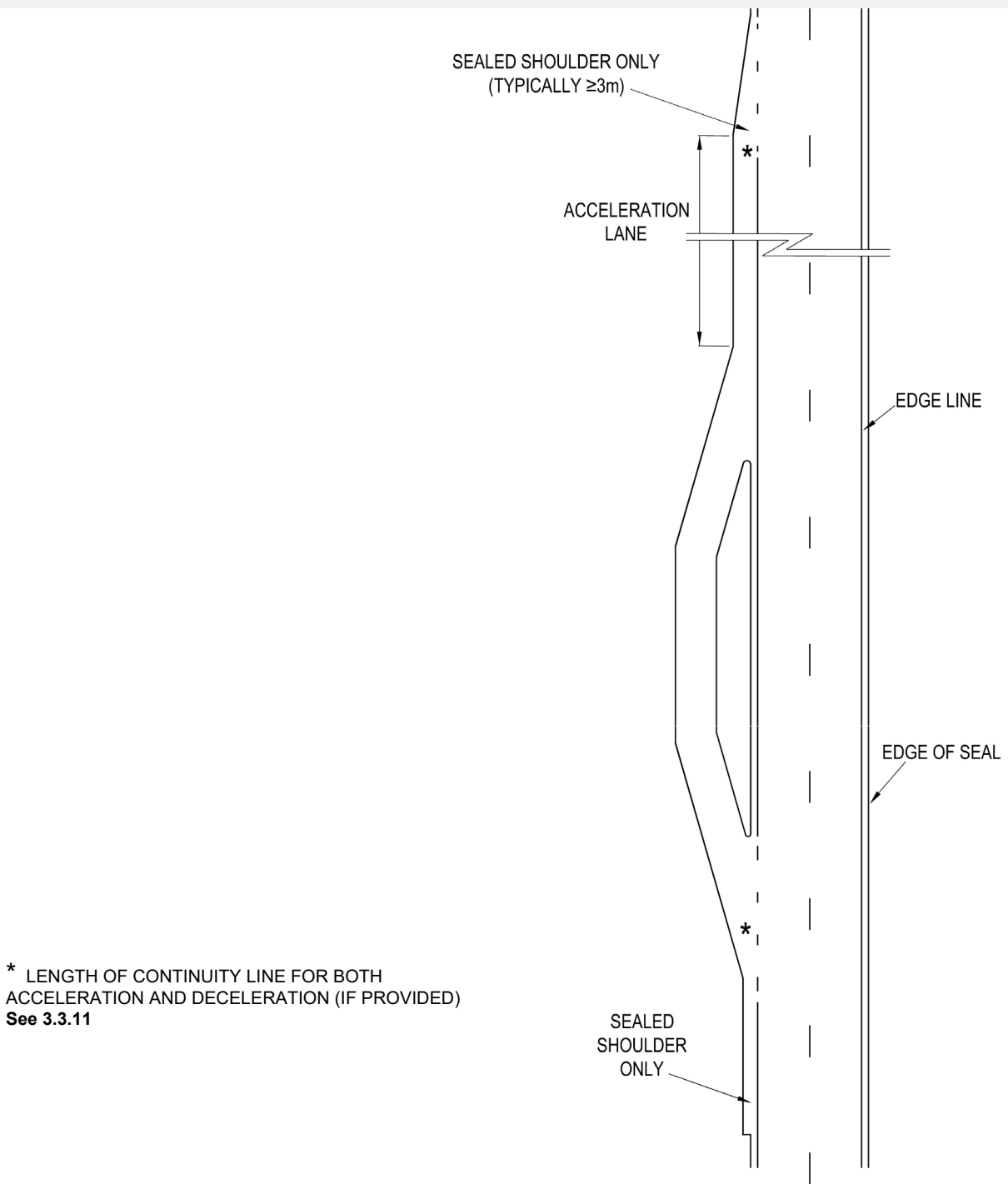

REST AREAS (continued)

3.4.10.2 Roads without edge lines

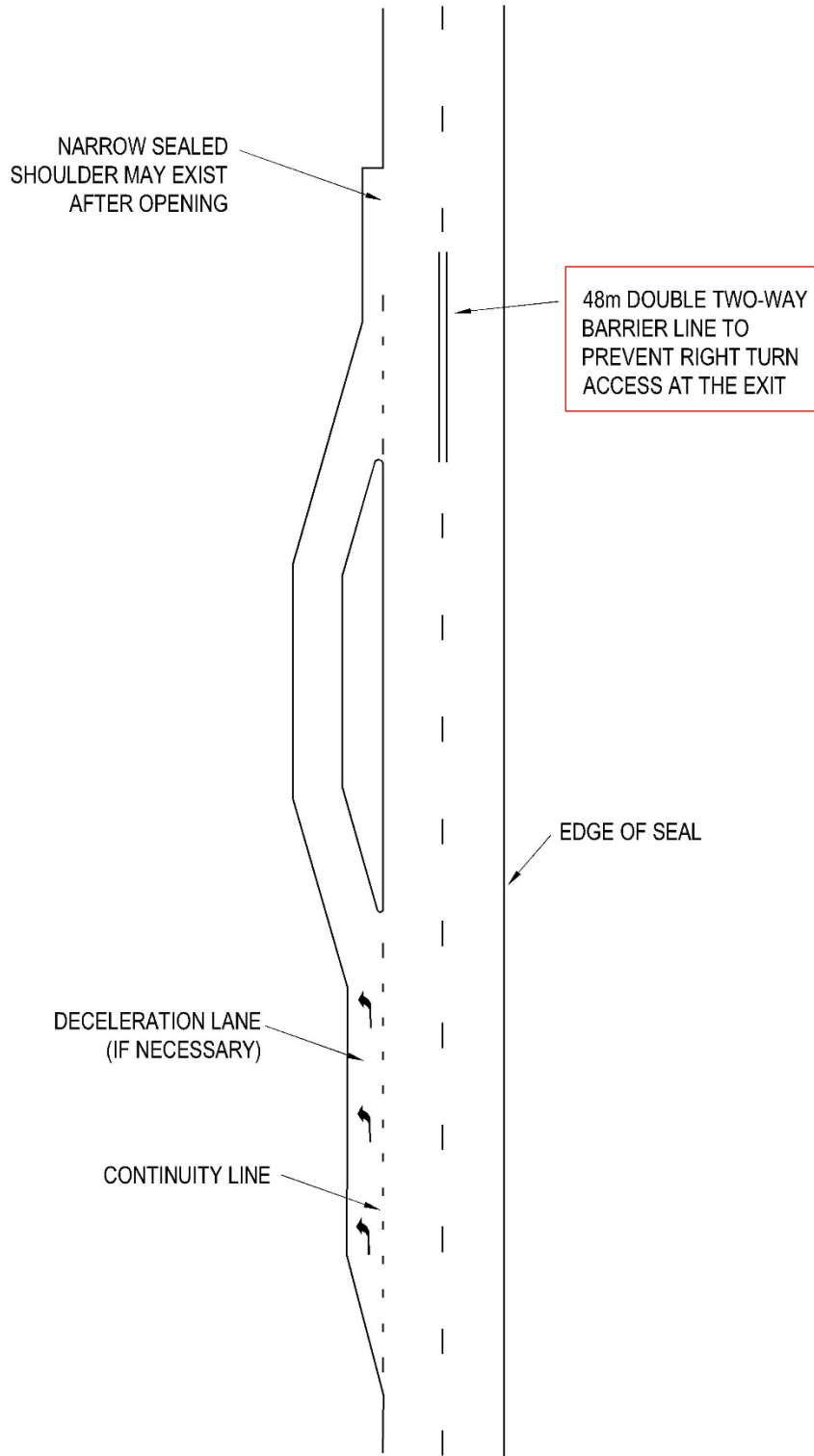

REST AREAS (continued)

3.4.10.3 Full acceleration / deceleration lane

NOTE: If additional reinforcement is required to prevent right turn access where an acceleration lane is provided, use 'No Entry' (R2-4) signs at rest area exit.

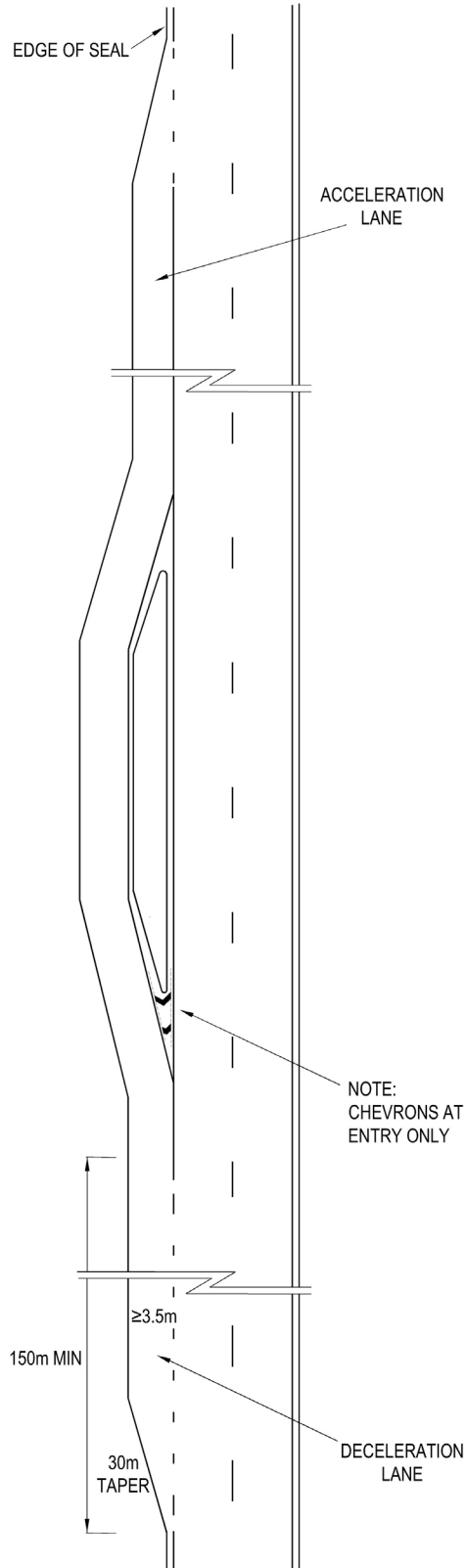

REST AREAS (continued)

3.4.10.4 Sealed shoulders only

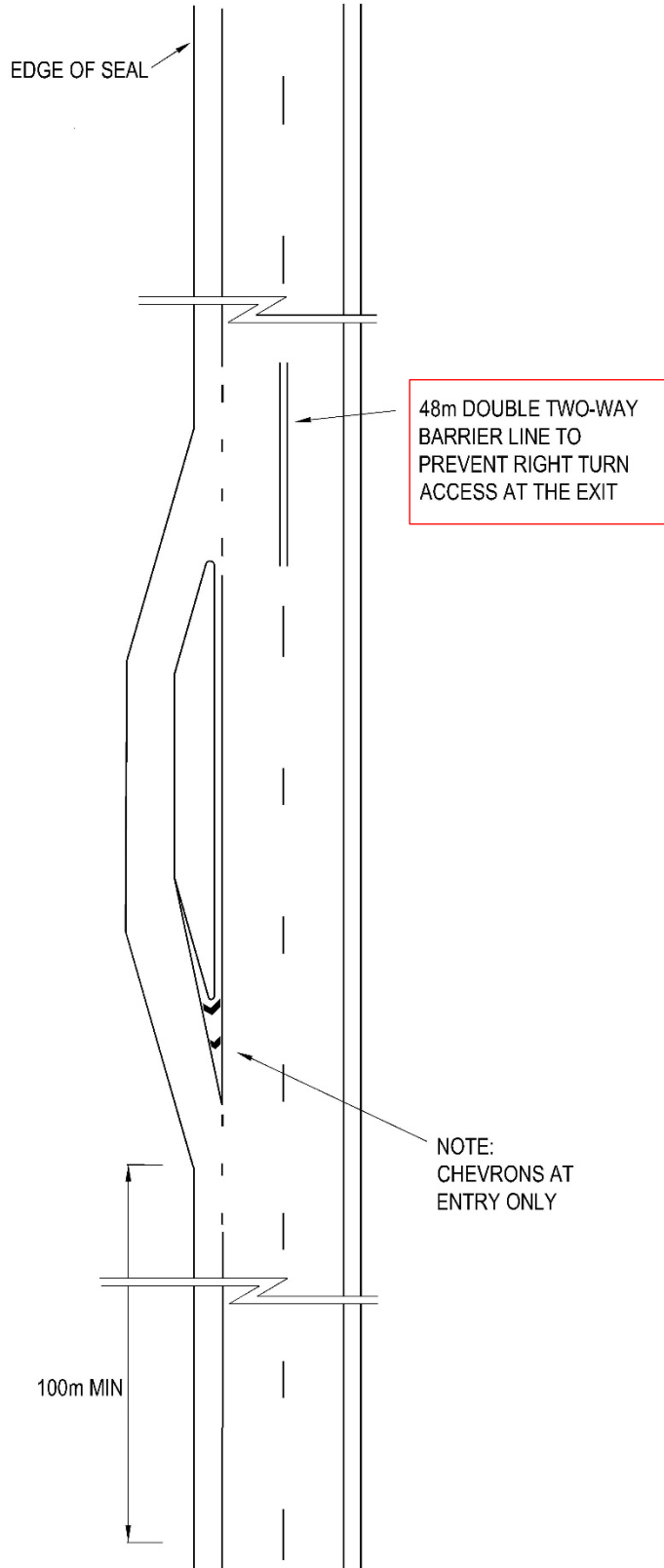

3.4.11 STRUCTURES AND OBSTRUCTIONS

Reference: ARR Rule 192 (1)

Includes narrow bridges and grids etc.

- All bridges and other road narrowings shall be edge lined.
- Barrier lines to be provided only in accordance with no overtaking zone sight distance requirements and only on roads greater than 5.5 m width.
- If the road is provided with an enhanced edge line, the enhanced edge line shall be continued across the narrow bridge to match.
- Special purpose broken lines to be used for dividing lines on floodways and causeways only, **see 3.4.12.**
- Yellow edge lines shall not be used as *ARR 192 (1)* applies.

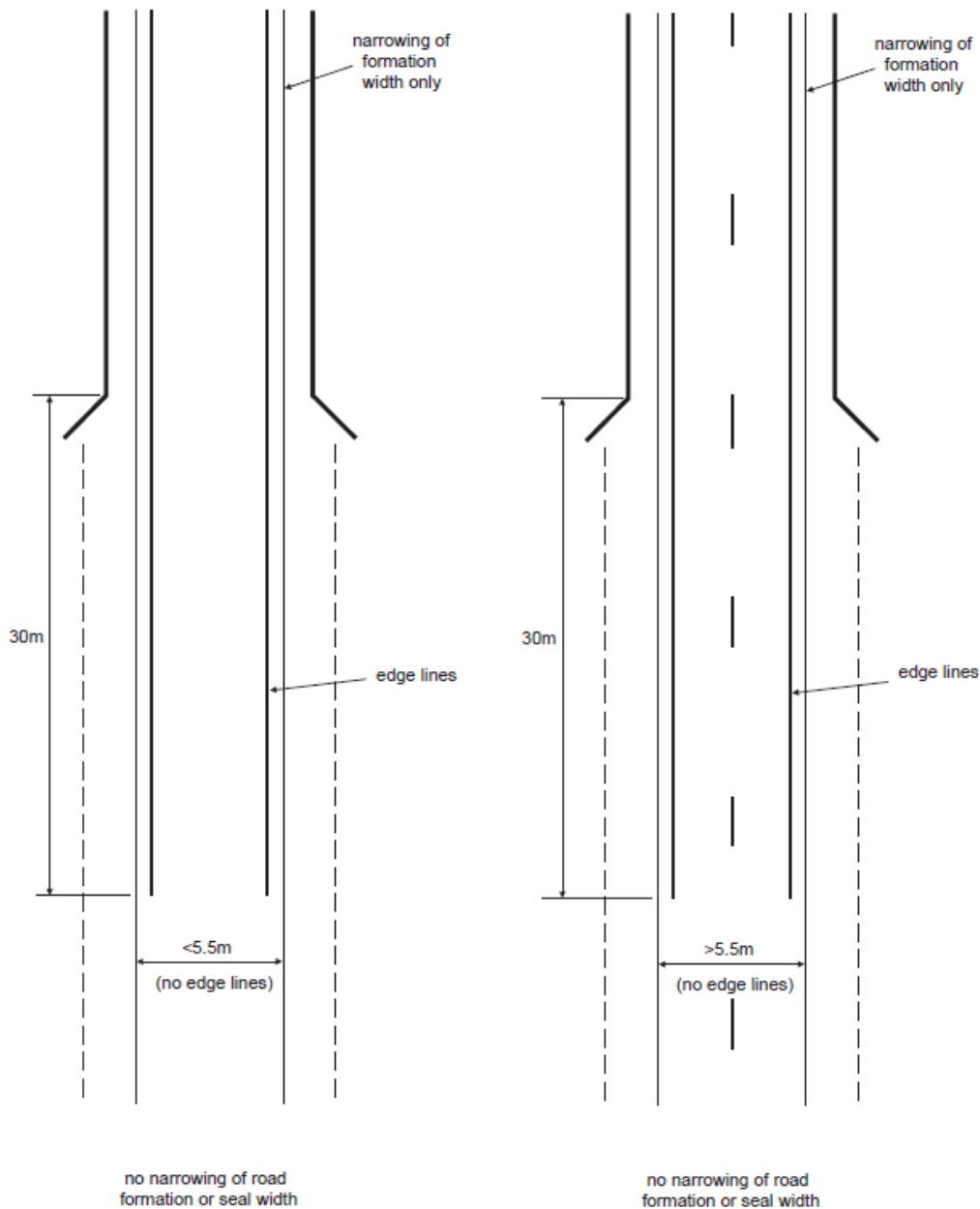

STRUCTURES AND OBSTRUCTIONS (continued)

Grid example

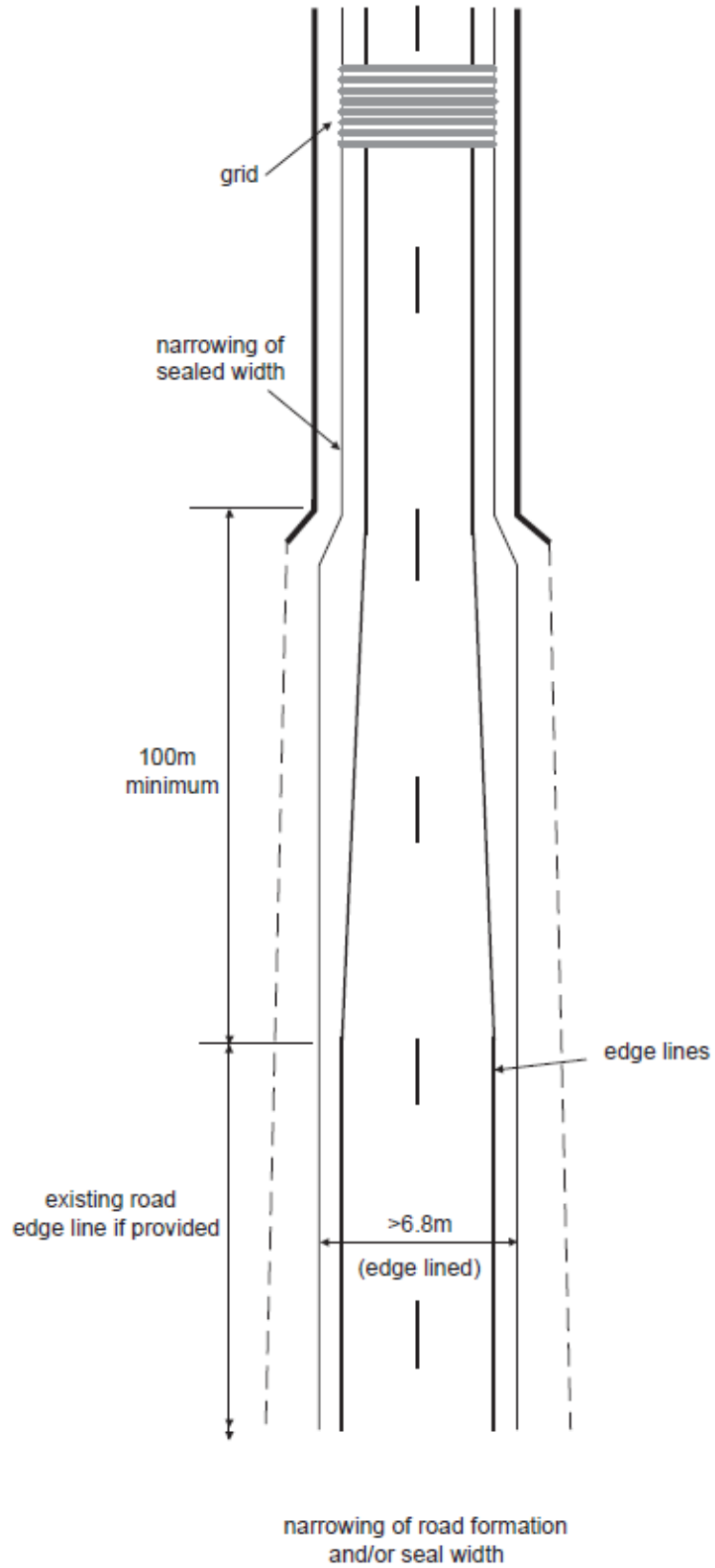

3.4.12 FLOODWAYS AND CAUSEWAYS

Reference: ARR Rule 192 (1)

Floodways and Causeways are sections of road that are subject to flooding. When water is over the road, delineation is reduced because the edge lines and particularly the standard dividing line (3 m line, 9 m gap) are very difficult to see through the water.

It is important not to unreasonably prohibit overtaking or u-turns by providing an unbroken barrier line. To increase delineation qualities of the dividing line while still allowing the line to be crossed, a special purpose broken dividing line (i.e. 9 m line, 3 m gap) shall be used across the section of road regularly subject to flooding.

If the vertical/horizontal sight distances are poor, on approaches to, and through the floodway, an unbroken barrier line shall be used.

Floodway/causeway examples

