

DRAFT PLANNING AND DESIGN CODE

→ STATE
PLANNING
REFORM

PORT AUGUSTA CITY COUNCIL
- Council Specific Code Extract

October 2019



**STATE
PLANNING
COMMISSION**

saplanningcommission.sa.gov.au



Government of South Australia

Department of Planning,
Transport and Infrastructure

Part 1 – Rules of Interpretation

This Part 1 forms part of the Planning and Design Code. It sets out how the Code implements the requirements of section 66 of the Act and instructs the user on how the Code is to be read and applied to development assessed under the *Planning, Development and Infrastructure Act 2016*.

Introduction

This is the Planning and Design Code under the *Planning, Development and Infrastructure Act 2016* (the Act). As provided by section 65 of the Act, the State Planning Commission (the Commission) is responsible for preparing and maintaining the Planning and Design Code as a statutory instrument under the Act. The Planning and Design Code, and any amendments to the Code, as published on the SA planning portal, have been adopted by the Minister.

As provided by section 66 of the Act, the primary purpose of the Planning and Design Code is to set out a comprehensive set of policies, rules and classifications which may be selected and applied in the various parts of the State through the operation of the Planning and Design Code and the SA planning database for the purposes of development assessment and related matters within the State.

The Planning and Design Code also provides for other matters envisaged by the Act, and regulations made under the Act in Parts 5, 6, 7, 8 and 9.

Commencement

The commencement date for the Planning and Design Code was 1 July 2019.

Information about amendments to the Planning and Design Code is set out in Appendix 1.

Preliminary

Library of classification criteria (Deemed-to-Satisfy criteria), policies and rules

In addition to the classification of development, the Planning and Design Code sets out a comprehensive set of policies and rules that may be selected and applied in the various parts of the State for the purposes of the assessment of performance assessed and restricted development.

The policies and rules are collated and organised into Zones, Subzones, Overlays and General Development Policies. Together they form a library of policies (“the Code Library”). The policies that make up the library have no application in their own right, but apply according to the scheme outlined in the following paragraphs.

The policies are applied to development by reference to classes of development, and spatial location.

Zones, Subzones and Overlays are assigned spatial boundaries in the various parts of the State through the operation of the SA planning database.

Classification of development

The Planning and Design Code classifies various classes of development as:

- a) accepted development (see section 104(1) of the Act); and
- b) deemed-to-satisfy development (see section 105(a) of the Act); and
- c) restricted development (see section 108(1)(a) of the Act).

All development is classified firstly by reference to its location and the Zone, Subzone and Overlays that are applicable to the location. Classification tables applicable to each Zone identify Accepted Development, Deemed-to-Satisfy development and Restricted Development.

Accepted Development

The Code classifies development as Accepted Development in an Accepted Development Classification Table relative to a particular Zone.

An Accepted Development Classification Table for each Zone specifies criteria which must be met in order for specified classes of development to be classified as Accepted Development within the Zone. For a development to be Accepted Development all criteria applicable to a class of development must be satisfied.

Deemed-to-Satisfy Development

The Code classifies development as deemed-to-satisfy development in a Deemed-to-Satisfy Development Classification Table relative to a particular Zone.

A Deemed-to-Satisfy Classification Table for each Zone specifies criteria which must be met in order for specified classes of development to be classified as deemed-to-satisfy development within the Zone. For a development to be deemed-to-satisfy development all criteria applicable to a class of development must be satisfied.

A deemed-to-Satisfy development does not require assessment against the policies and rules applicable to performance assessed development, and must be granted a consent subject to the requirements of section 106 of the Act.

Restricted Development

The Code classifies development as restricted development in a Restricted Development Table relative to each Zone. Restricted development is a form of impact assessed development for the purposes of assessment under the Act.

Performance Assessed Development - Application of Policies to Govern Performance assessed development

All development not classified as accepted, deemed-to-satisfy, restricted or impact assessed is to be assessed on its merits against the Planning and Design Code, as contemplated by section 107 of the Act. This is referred to as performance assessed development.

Application of Policies to Classes of Development

The Code applies policies to classes of development through an Applicable Policies for Performance Assessed Development Table relative to each Zone.

An Applicable Policies for Performance Assessed Development Table for each Zone specifies the policies and rules (selected from the Code library) that apply to classes of development within the Zone, including by the application of policies within Subzones and Overlays, together with the relevant General Development Policies. The Applicable Policies for Performance Assessed Development Tables also contain rules for application of the policies under the heading "Applicable Policies" including rules relating to the application of Desired Outcome policies and Designated Performance Features. The policies specified in the Applicable Policies for Performance Assessed Development Table constitute the policies applicable to the class of development within the Zone to the exclusion of all other policies within the Code library, and no other policies are applicable.

Development that does not fall within one of the specified classes of development in an Applicable Policies for Performance Assessed Development Table is designated in the Table as "All Other Development". In respect of all other development, all policies from the Zone and Subzone, and all policies in Overlays that have application to the spatial location of the development, and all General Development Policies, are selected and applied for the purpose of assessment.

Relevant Provisions

For the purposes of section 102 of the Act the relevant authority must assess the development against the applicable policies specified by the Zone Applicable Policies for Performance Assessed Development Table that are relevant to the particular development. For the avoidance of doubt, the relevant authority may determine that one or more applicable policies is not relevant to a particular development.

Policies – Desired Outcomes and Performance Outcomes

Zone, Subzone, Overlay and General Development Policies are comprised of desired outcomes and performance outcomes. These are applicable to performance assessed development and to restricted development.

Desired outcomes are policies designed to aid the interpretation of performance outcomes by setting a general policy agenda for a Zone, Subzone, Overlay or General Development Policies module. Where a relevant authority is uncertain as to whether or how a performance outcome applies to a development, the desired outcome(s) may inform its consideration of the relevance and application of a performance outcome, or in assessing the merits of the development against the applicable performance outcomes collectively.

Performance outcomes are policies designed to facilitate assessment according to specified factors, including land use, site dimensions and land division, built form and character and hazard risk minimisation.

In order to assist a relevant authority to interpret the performance outcomes, in some cases the policy includes a standard outcome which will generally meet the corresponding performance outcome (a *designated performance feature* or DPF). Without derogating from the need to assess development on its merits against all relevant policies, a DPF provides a guide to the relevant authority as to what is generally considered to satisfy the corresponding performance outcome but does not derogate from the discretion to determine that the outcome is met in another way.

Restricted Development

For the purpose of restricted development in all Zones, all policies and rules relative to the spatial location of the development together with all General Development Policies are applicable and may be determined by the Commission to be relevant for the purposes of a particular restricted development pursuant to s110(10) of the Act.

Spatial Information

Spatial boundaries of Zones, Subzones and Overlays in relation to the parts of the State to which the Planning and Design Code applies are accessed through the SA planning database.

The classifications, rules and policies applicable to a particular class of Zone, or to a Subzone or Overlay determined in the manner set out in this Introduction, are applied to the various parts of the State by reference to the correspondingly named Zones, Subzones and Overlays that the SA planning database provides access to.

Hierarchy of Policies/Modification of Provisions

Where there is an inconsistency between provisions in the library of policies, and for the purpose of section 66(3)(b) of the Act, the following rules will apply to the extent of any inconsistency between policies:

the provisions of an Overlay will prevail over all other policies applying in the particular case;

- a) a Subzone policy will prevail over a Zone policy or a General Development Policy; and
- b) a Zone policy will prevail over a General Development Policy.

Procedural Matters – Referrals

The Code also interacts with Schedule 9 of the Planning, Development and Infrastructure (General) Regulations 2017 for the purposes of section 122 of the Act. Schedule 9 prescribes development that, by reference to location, class or other features as specified in each item in the table in clause 3 of Schedule 9, and class as specified by the Code, must be referred to a body prescribed in Schedule 9. For the purposes of the specified items in the table in clause 3 of Schedule 9, the Code contains Referral Tables relative to Overlays, Zones and General Development modules. Referral Tables specify classes of development requiring referral to a prescribed body by the mechanism described in paragraph 6.2.

Referral Tables specify classes of development to which an item in the table in clause 3 of Schedule 9, identified by reference to the prescribed referral body, applies. In addition, Referral Tables identify the purpose of the referral (that being a matter that is considered by the Commission under section 66(2)(e)(ii) of the Act as being appropriate to include in the Code). Development that is within a class specified by the Referral Table, and otherwise within the corresponding item in the table in clause 3 of Schedule 9, must be referred to the prescribed referral body pursuant to s122 of the Act.

Interpretation

Definitions and Other Rules of Interpretation

A term used in the Planning and Design Code may have a meaning specifically assigned to that term by one of the following:

- a) the *Planning, Development and Infrastructure Act 2016* (the Act);
- b) the *Acts Interpretation Act 1915* (South Australia);
- c) the definitions in Parts 7 and 8 of the Planning and Design Code.

In the event a term has been assigned a meaning in more than one of the Code's parts (ie. a Zone, Subzone, Overlay, or General Development Policy), the meaning contained in the part that sits highest in the hierarchy of policies under clause 4 in Part 1 will prevail.

A reference in the Planning and Design Code to an Act includes a reference to any regulations or instrument made under the Act, and where an Act, regulation or instrument has been amended or replaced, if the context permits, includes a reference to the amended or replaced Act, regulations or instrument.

A reference in the Planning and Design Code to a specific resource document or standard, means the latest version of the resource document or standard.

Unless otherwise indicated, a reference in the Planning and Design Code to a Part, section or table is a reference to a Part, section or table of the Code.

Part 2 – Zones and Sub Zones

Commonwealth Facility Zone

Table 1 – Accepted Development Classification

Class of Development The following Classes of Development are classified as Accepted Development subject to meeting the 'Accepted Development Classification Criteria'	Accepted Development Classification Criteria
Building work on railway land	<ol style="list-style-type: none"> 1 Building work is associated with a railway 2 It is situated (or to be situated) on railway land 3 It is required for the conduct or maintenance of railway activities.
Carport Except where any of the following apply: <ul style="list-style-type: none"> • Coastal Areas Overlay • Hazards (Flooding) Overlay • Native Vegetation Overlay • State Significant Native Vegetation Overlay • Sloping Land Overlay • Key Outback and Rural Routes Overlay where an existing access is altered or a new access is created • Water Resources Overlay 	<ol style="list-style-type: none"> 1 The development will not be built, or encroach, on an area that is, or will be, required for a sewerage system or waste control system 2 It is ancillary to a dwelling erected on the site 3 Primary street setback – at least 5.5m from the primary street boundary and as far back as the building line of the building to which it is ancillary 4 Secondary street setback – at least 900mm from the boundary of the allotment (if the land has boundaries on two or more roads) 5 Total floor area - does not exceed 40m² 6 Post height - does not exceed 3m measured from natural ground level (and not including a gable end) 7 Building height - does not exceed 5m 8 If situated on or abutting a boundary (not being a boundary with a primary street or secondary street) – a length not exceeding 10m unless: <ol style="list-style-type: none"> (a) a longer wall or structure exists on the adjacent site and is situated on the same allotment boundary; and (b) the proposed wall or structure will be built along the same length of boundary as the existing adjacent wall or structure to the same or lesser extent 9 If the carport abuts or is situated on the boundary of the allotment (not being a boundary with a primary street or secondary street): <ol style="list-style-type: none"> (a) it will not result in all relevant walls or structures located along the boundary exceeding 45% of the length of the boundary; and (b) it will not be located within 3m of any other wall along the same boundary unless on an adjacent site on that boundary there is an existing wall of a building that would be adjacent to or abut the proposed wall or structure 10 The total roofed area of all existing or proposed buildings on the allotment does not exceed 60% of the area of the allotment

	<p>11 Door opening for vehicle access – does not exceed, in total, 7m in width or 50% of the width of the allotment frontage (whichever lesser)</p> <p>12 Internal dimensions – does not exceed 3.2m in width and 6m in length between all fences, walls and doors</p> <p>13 The carport:</p> <p>(a) is located so that vehicle access:</p> <ol style="list-style-type: none"> i. is provided via a lawfully existing or authorised driveway or access point or an access point for which consent has been granted as part of an application for the division of land; or ii. will use a driveway that: <ol style="list-style-type: none"> A. is not located within 6 metres of an intersection of 2 or more roads or a pedestrian actuated crossing; and B. will not interfere with an item of street furniture (including directional signs, lighting, seating and weather shelters), other infrastructure, or a tree; or iii. if adjacent a kerbed road, will be via a kerb that is designed to allow a vehicle to roll over it; and <p>(b) is located so that the gradient from the place of access on the boundary of the allotment to the finished floor level at the front of the carport when the work is completed is not steeper than 1:4 on average; and</p> <p>(c) The centre of the driveway at the public road boundary is no more than 25 degree deviation from the centre of the front of the covered car parking space for which it provides vehicle access</p>
Demolition	None.
Internal building work	<ol style="list-style-type: none"> 1 There will be no increase in the total floor area of the building 2 There will be no alteration to the external appearance of the building.
<p>Outbuilding (in the form of a garage) Except where any of the following apply:</p> <ul style="list-style-type: none"> • Coastal Areas Overlay • Hazards (Flooding) Overlay • Native Vegetation Overlay • State Significant Native Vegetation Overlay • Sloping Land Overlay • Key Outback and Rural Routes Overlay where an existing access is altered or a new access is created • Water Resources Overlay 	<ol style="list-style-type: none"> 1 The development will not be built, or encroach, on an area that is, or will be, required for a sewerage system or waste control system 2 It is detached from and ancillary to a dwelling erected on the site. 3 Primary street setback – at least 5.5m from the primary street boundary and as far back as the building line of the building to which it is ancillary 4 Secondary street setback – at least 900mm from the boundary of the allotment (if the land has boundaries on two or more roads) 5 Total floor area - does not exceed 40m² 6 Wall height - does not exceed 3m measured from natural ground level (and not including a gable end) 7 Building height - does not exceed 5m 8 If situated on or abutting a boundary (not being a boundary with a primary street or secondary street) – a length not exceeding 10m unless:

	<ul style="list-style-type: none"> (a) a longer wall or structure exists on the adjacent site and is situated on the same allotment boundary; and (b) the proposed wall or structure will be built along the same length of boundary as the existing adjacent wall or structure to the same or lesser extent <p>9 If the outbuilding abuts or is situated on the boundary of the allotment (not being a boundary with a primary street or secondary street):</p> <ul style="list-style-type: none"> (a) it will not result in all relevant walls or structures located along the boundary exceeding 45% of the length of the boundary; and (b) it will not be located within 3m of any other wall along the same boundary unless on an adjacent site on that boundary there is an existing wall of a building that would be adjacent to or abut the proposed wall or structure <p>10 Total roofed area of all existing and proposed buildings on the allotment - does not exceed 60%</p> <p>11 Internal dimensions – exceed 3.2m in width and 6m in length between all walls and doors</p> <p>12 Door opening for vehicle access – does not exceed, in total, 7m in width or 50% of the width of the allotment frontage (whichever lesser)</p> <p>13 The garage:</p> <ul style="list-style-type: none"> (a) is located so that vehicle access: <ul style="list-style-type: none"> i. is provided via a lawfully existing or authorised driveway or access point or an access point for which consent has been granted as part of an application for the division of land; or ii. will use a driveway that: <ul style="list-style-type: none"> A. is not located within 6 metres of an intersection of 2 or more roads or a pedestrian actuated crossing; and B. will not interfere with an item of street furniture (including directional signs, lighting, seating and weather shelters), other infrastructure, or a tree; or iii. if adjacent a kerbed road, will be via a kerb that is designed to allow a vehicle to roll over it; and (b) is located so that the gradient from the place of access on the boundary of the allotment to the finished floor level at the front of the carport when the work is completed is not steeper than 1:4 on average; and (c) The centre of the driveway at the public road boundary is no more than 25 degree deviation from the centre of the front of the covered car parking space for which it provides vehicle access <p>14 If clad in sheet metal—is pre-colour treated or painted in a non-reflective colour.</p>
<p>Outbuilding (not being a garage) Except where any of the following apply:</p>	<p>1 The development will not be built, or encroach, on an area that is, or will be, required for a sewerage system or waste control system</p>

<ul style="list-style-type: none"> • Coastal Areas Overlay • Hazards (Flooding) Overlay • Native Vegetation Overlay • State Significant Native Vegetation Overlay • Sloping Land Overlay • Water Resources Overlay 	<ol style="list-style-type: none"> 2 It is detached from and ancillary to a dwelling erected on the site 3 Primary street setback – at least as far back as the building line of the building to which it is ancillary 4 Secondary street setback – at least 900mm from the boundary of the allotment (if the land has boundaries on two or more roads) 5 Side boundary setbacks – at least 900mm from the boundary of the allotment 6 Total floor area does not exceed 40m² 7 Wall height - does not exceed 3m measured from natural ground level (and not including a gable end) 8 Building height - does not exceed 5m 9 If situated on or abutting a boundary (not being a boundary with a primary street or secondary street) – a length not exceeding 10m unless: <ol style="list-style-type: none"> (a) a longer wall or structure exists on the adjacent site and is situated on the same allotment boundary; and (b) the proposed wall or structure will be built along the same length of boundary as the existing adjacent wall or structure to the same or lesser extent 10 If the outbuilding abuts or is situated on the boundary of the allotment (not being a boundary with a primary street or secondary street): <ol style="list-style-type: none"> (a) it will not result in all relevant walls or structures located along the boundary exceeding 45% of the length of the boundary; and (b) will not be located within 3m of any other wall along the same boundary unless on an adjacent site on that boundary there is an existing wall of a building that would be adjacent to or abut the proposed wall or structure 11 Total roofed area of all existing and proposed buildings on the allotment - does not exceed 60% 12 If clad in sheet metal—is pre-colour treated or painted in a non-reflective colour.
<p>Private bushfire shelters Except where any of the following apply:</p> <ul style="list-style-type: none"> • Coastal Areas Overlay • Hazards (Flooding) Overlay • Native Vegetation Overlay • State Significant Native Vegetation Overlay • Sloping Land Overlay • Water Resources Overlay 	<ol style="list-style-type: none"> 1 The development will not be built, or encroach, on an area that is, or will be, required for a sewerage system or waste control system 2 Primary street setback – at least as far back as the building to which it is ancillary 3 Secondary street setback – at least 900mm from the boundary of the allotment 4 At least 6m from the corner of an allotment which abuts the intersection of two or more roads (other than where a 4m x 4m allotment cut-off is already in place).
<p>Shade sail Except where any of the following apply:</p> <ul style="list-style-type: none"> • Coastal Areas Overlay 	<ol style="list-style-type: none"> 1 The development will not be built, or encroach, on an area that is, or will be, required for a sewerage system or waste control system 2 Shade sail consists of permeable material 3 The total area of the sail - does not exceed 40m²

<ul style="list-style-type: none"> • Hazards (Flooding) Overlay • Native Vegetation Overlay • State Significant Native Vegetation Overlay • Sloping Land Overlay • Water Resources Overlay 	<ol style="list-style-type: none"> 4 No part of the shade sail will be: <ol style="list-style-type: none"> (a) 3m above ground or floor level (depending on where it is situated) at any place within 900mm of a boundary of the allotment (b) 5m above ground or floor level (depending on where it is situated) within any other part of the allotment 5 Primary street setback – at least as far back as the building line of the building to which it is ancillary 6 If any part of the sail will be situated on a boundary of the allotment, the length of sail along a boundary does not exceed 8m 7 In a case where any part of the sail or a supporting structure will be situated on a side boundary of the allotment — the length of the sail and any such supporting structure together with all relevant walls or structures located along the boundary will not exceed 45% of the length of the boundary.
<p>Solar photovoltaic panels (roof mounted)</p>	<ol style="list-style-type: none"> 1 Panels are installed parallel to the roof of a building and with the underside surface of the panel not being more than 100mm above the surface of the roof 2 Panels and associated components do not overhang any part of the roof 3 Does not apply to system with a generating capacity of more than 5MW that is to be connected to the State's power system.
<p>Spa pool Swimming pool Except where any of the following apply:</p> <ul style="list-style-type: none"> • Coastal Areas Overlay • Hazards (Flooding) Overlay • Native Vegetation Overlay • State Significant Native Vegetation Overlay • Sloping Land Overlay • Water Resources Overlay 	<ol style="list-style-type: none"> 1 The development will not be built, or encroach, on an area that is, or will be, required for a sewerage system or waste control system 2 It is ancillary to a dwelling erected on the site 3 Allotment boundary setback – not less than 1m 4 Primary street setback – at least as far back as the building line of the building to which it is ancillary 5 Location of filtration system from a dwelling on an adjoining allotment: <ol style="list-style-type: none"> (a) not less than 5m where the filtration system is located inside a solid structure that will have material impact on the transmission of noise (b) not less than 12m in any other case.
<p>Verandah Except where any of the following apply:</p> <ul style="list-style-type: none"> • Coastal Areas Overlay • Hazards (Flooding) Overlay • Native Vegetation Overlay • State Significant Native Vegetation Overlay • Water Resources Overlay 	<ol style="list-style-type: none"> 1 The development will not be built, or encroach, on an area that is, or will be, required for a sewerage system or waste control system 2 It is ancillary to a dwelling erected on the site 3 Primary street setback – as far back as the building line of the building to which it is ancillary 4 Total floor area - does not exceed 40m² 5 Post height - does not exceed 3m measured from natural ground level 6 Building height - does not exceed 5m 7 Length - does not exceed 10m if any part of the structure abuts or is situated on a boundary of the allotment 8 Total roofed area of all existing and proposed buildings on the allotment - does not exceed 60%.

<p>Water tank (above ground) Except where any of the following apply</p> <ul style="list-style-type: none"> • Coastal Areas Overlay • Hazards (Flooding) Overlay • Native Vegetation Overlay • State Significant Native Vegetation Overlay • Sloping Land Overlay • Water Resources Overlay 	<ol style="list-style-type: none"> 1 The development will not be built, or encroach, on an area that is, or will be, required for a sewerage system or waste control system 2 The tank is part of a roof drainage system 3 Total floor area - not exceeding 15m² 4 The tank is located wholly above ground 5 Tank height – does not exceed 4m above natural ground level 6 Primary street setback – at least as far back as the building line of the building to which it is ancillary 7 In the case of a tank made of metal – the tank is pre-colour treated or painted in a non-reflective colour.
<p>Water tank (underground) Except where any of the following apply:</p> <ul style="list-style-type: none"> • Coastal Areas Overlay • Native Vegetation Overlay • State Significant Native Vegetation Overlay • Sloping Land Overlay • Water Resources Overlay 	<ol style="list-style-type: none"> 1 The development will not be built, or encroach, on an area that is, or will be, required for a sewerage system or waste control system 2 The tank (including any associated pump) is located wholly below the level of the ground.
<p>Protective tree netting structure Except where any of the following apply:</p> <ul style="list-style-type: none"> • Coastal Areas Overlay • State Significant Native Vegetation Overlay • Sloping Land Overlay • Water Resources Overlay 	<ol style="list-style-type: none"> 1 The development will not be built, or encroach, on an area that is, or will be, required for a sewerage system or waste control system 2 No part of the protective tree netting structure will be more than 6m above natural ground level (depending on where it is situated) 3 Netting visible from the outside of the protective tree netting structure is of a low light-reflective nature, and, in the case of a structure that has side netting, the side netting is of a dark colour 4 In the case of a development on a site that is within a Hazards (Bushfire - Outback) Overlay, Hazards (Bushfire – Regional) Overlay, Hazards (Bushfire - General Risk) Overlay, Hazards (Bushfire Medium - Risk) Overlay or Hazards (Bushfire - High Risk) Overlay, the protective tree netting structure provides for access to the site in accordance with the following: <ol style="list-style-type: none"> (a) no part of the protective tree netting structure (including cables and points of attachment of cables (known as "auger" or "anchor" points) will be within 5m of any boundary of the site; or (b) does not prevent access or movement of vehicles of 4m height and 3.5m width (or less) on any access road or track (including fire tracks) on the site 5 No part of the netting canopy of the protective tree netting structure: <ol style="list-style-type: none"> (a) will cover native vegetation; or (b) will be within 5m of a road (including any road reserve)

	<p>6 The points of attachment of any cables will not be located:</p> <ul style="list-style-type: none">(a) outside the boundaries of the site; or(b) within a watercourse (within the meaning of the Natural Resources Management Act 2004) <p>7 In relation to a dwelling located on an allotment adjoining the site on which the protective tree netting structure is located, the protective tree netting structure complies with the following:</p> <ul style="list-style-type: none">(a) if the netting canopy nearest the dwelling on the adjoining allotment is 4m or less above ground level (depending on where it is situated), no part of the netting canopy is within 10m of the dwelling(b) in any other case, no part of the netting canopy is within 15m of the dwelling.
--	--

Table 2 - Deemed-to-Satisfy Development Classification

Class of Development The following Classes of Development are classified as Deemed-to-Satisfy Development subject to meeting the 'Deemed-to-Satisfy Development Classification Criteria'	Deemed-to-Satisfy Development Classification Criteria Provisions referred to are Deemed-to-Satisfy Criteria Where a development comprises more than one Class of Development the relevant criteria will be taken to be the sum of the criteria for each Class of Development.			
	Zone	General Development Policies	Subzone (applies only in the area affected by the Subzone)	Overlay (applies only in the area affected by the Overlay)
None specified				

Table 3 – Applicable Policies for Performance Assessed Development

Class of Development	Applicable Policies			
	Zone	General Development Policies	Subzone (applies only in the area affected by the Subzone)	Overlay (applies only in the area affected by the Overlay)
All Code Assessed Development	All	All	None	Any Relevant Overlays: All

Table 4 –Restricted Development Classification

Class of Development The following Classes of Development are classified as Restricted subject to any 'Exclusions'	Exclusions
None Specified	

Assessment Provisions (AP)

Desired Outcome (DO)

DO 1

A zone accommodating nationally significant aviation and defence related activities.

[**NOTE:** Land in the zone is subject to Commonwealth laws where development may occur without the need for an approval under the *Planning, Development and Infrastructure Act 2016*. In circumstance where a class of development is proposed that is subject to State planning laws, the development is subject to assessment against the Planning and Design Code]

Performance Outcomes and Deemed to Satisfy / Designated Performance Outcome Criteria

Land Use

PO 1.1

Commonwealth aviation and defence related development and complementary activities.

DTS/DPF 1.1

None are applicable.

Procedural Matters (PM)

Notification
None specified.
Placement of Notices – Exemptions for Performance Assessed Development
None specified.
Placement of Notices – Exemptions for Restricted Development
None specified.

Community Facilities Zone

Table 1 – Accepted Development Classification

Class of Development The following Classes of Development are classified as Accepted Development subject to meeting the 'Accepted Development Classification Criteria'	Accepted Development Classification Criteria
Building work on railway land	4 Building work is associated with a railway 5 It is situated (or to be situated) on railway land 6 It is required for the conduct or maintenance of railway activities.
Internal building work Except where any of the following apply: <ul style="list-style-type: none"> • Historic Area Overlay • Local Heritage Place identified in the Local Heritage Place Overlay • State Heritage Area Overlay • State Heritage Place identified in the State Heritage Place Overlay 	3 There will be no increase in the total floor area of the building 4 There will be no alteration to the external appearance of the building.
Private bushfire shelters Except where any of the following apply: <ul style="list-style-type: none"> • Character Preservation District Overlay • Coastal Areas Overlay • Hazards (Acid Sulfate Soils) Overlay • Hazards (Flooding) Overlay • Character Area Overlay • Historic Area Overlay • Local Heritage Place Overlay • State Heritage Area Overlay • State Heritage Place Overlay 	5 The development will not be built, or encroach, on an area that is, or will be, required for a sewerage system or waste control system 6 Primary street setback – at least as far back as the building to which it is ancillary 7 Secondary street setback – at least 900mm from the boundary of the allotment 8 At least 6m from the corner of an allotment which abuts the intersection of two or more roads (other than where a 4m x 4m allotment cut-off is already in place).

<ul style="list-style-type: none"> • Native Vegetation Overlay • State Significant Native Vegetation Overlay • Ramsar Wetlands Overlay • River Murray Flood Plain Overlay • Sloping Land Overlay • Water Resources Overlay 	
<p>Shade sail Except where any of the following apply:</p> <ul style="list-style-type: none"> • Character Preservation District Overlay • Coastal Areas Overlay • Hazards (Acid Sulfate Soils) Overlay • Character Area Overlay • Historic Area Overlay • Local Heritage Place Overlay • State Heritage Area Overlay • State Heritage Place Overlay • Native Vegetation Overlay • State Significant Native Vegetation Overlay • Ramsar Wetlands Overlay • River Murray Flood Plain Overlay • Sloping Land Overlay • Water Resources Overlay 	<p>8 The development will not be built, or encroach, on an area that is, or will be, required for a sewerage system or waste control system</p> <p>9 Shade sail consists of permeable material</p> <p>10 The total area of the sail - does not exceed 40m²</p> <p>11 No part of the shade sail will be:</p> <p>(a) 3m above ground or floor level (depending on where it is situated) at any place within 900mm of a boundary of the allotment</p> <p>(b) 5m above ground or floor level (depending on where it is situated) within any other part of the allotment</p> <p>12 Primary street setback – at least as far back as the building line of the building to which it is ancillary</p> <p>13 If any part of the sail will be situated on a boundary of the allotment, the length of sail along a boundary does not exceed 8m</p> <p>14 In a case where any part of the sail or a supporting structure will be situated on a side boundary of the allotment — the length of the sail and any such supporting structure together with all relevant walls or structures located along the boundary will not exceed 45% of the length of the boundary.</p>
<p>Solar photovoltaic panels (roof mounted) Except where any of the following apply:</p> <ul style="list-style-type: none"> • Historic Area Overlay • Local Heritage Place identified in the Local Heritage Place Overlay • State Heritage Area Overlay • State Heritage Place identified in the State Heritage Place Overlay 	<p>4 Panels are installed parallel to the roof of a building and with the underside surface of the panel not being more than 100mm above the surface of the roof</p> <p>5 Panels and associated components do not overhang any part of the roof</p> <p>6 Does not apply to system with a generating capacity of more than 5MW that is to be connected to the State's power system.</p>

<p>Spa pool Swimming pool Except where any of the following apply:</p> <ul style="list-style-type: none"> • Character Preservation District Overlay • Coastal Areas Overlay • Hazards (Acid Sulfate Soils) Overlay • Hazards (Flooding) Overlay • Character Area Overlay • Historic Area Overlay • Local Heritage Place Overlay • State Heritage Area Overlay • State Heritage Place Overlay • Native Vegetation Overlay • State Significant Native Vegetation Overlay • Ramsar Wetlands Overlay • River Murray Flood Plain Overlay • Sloping Land Overlay • Water Resources Overlay 	<ol style="list-style-type: none"> 6 The development will not be built, or encroach, on an area that is, or will be, required for a sewerage system or waste control system 7 It is ancillary to a building erected on the site 8 Allotment boundary setback – not less than 1m 9 Primary street setback – at least as far back as the building line of the building to which it is ancillary 10 Location of filtration system from a building on an adjoining allotment: <ol style="list-style-type: none"> (a) not less than 5m where the filtration system is located inside a solid structure that will have material impact on the transmission of noise (b) not less than 12m in any other case.
<p>Water tank (above ground)</p> <ul style="list-style-type: none"> • Character Preservation District Overlay • Coastal Areas Overlay • Hazards (Flooding) Overlay • Character Area Overlay • Historic Area Overlay • Local Heritage Place Overlay • State Heritage Area Overlay • State Heritage Place Overlay • Native Vegetation Overlay • State Significant Native Vegetation Overlay • Ramsar Wetlands Overlay • River Murray Flood Plain Overlay • Sloping Land Overlay • Water Resources Overlay 	<ol style="list-style-type: none"> 8 The development will not be built, or encroach, on an area that is, or will be, required for a sewerage system or waste control system 9 The tank is part of a roof drainage system 10 Total floor area - not exceeding 15m² 11 The tank is located wholly above ground 12 Tank height – does not exceed 4m above natural ground level 13 Primary street setback – at least as far back as the building line of the building to which it is ancillary 14 In the case of a tank made of metal – the tank is pre-colour treated or painted in a non-reflective colour.

Water tank (underground)

Except where any of the following apply:

- Character Preservation District Overlay
- Coastal Areas Overlay
- Hazards (Acid Sulfate Soils) Overlay
- Native Vegetation Overlay
- State Significant Native Vegetation Overlay
- Ramsar Wetlands Overlay
- Sloping Land Overlay
- Water Resources Overlay

- 3 The development will not be built, or encroach, on an area that is, or will be, required for a sewerage system or waste control system
- 4 The tank (including any associated pump) is located wholly below the level of the ground.

Table 2 – Deemed-to-Satisfy Development Classification

Class of Development The following Classes of Development are classified as Deemed-to-Satisfy Development subject to meeting the 'Deemed-to-Satisfy Development Classification Criteria'	Deemed-to-Satisfy Development Classification Criteria Provisions referred to are Deemed-to-Satisfy Criteria Where a development comprises more than one Class of Development the relevant criteria will be taken to be the sum of the criteria for each Class of Development.			
	Zone	General Development Policies	Subzone (applies only in the area affected by the Subzone)	Overlay (applies only in the area affected by the Overlay)
Advertisement Except where any of the following apply: <ul style="list-style-type: none"> • Advertising Near Signalised Intersections Overlay • Character Area Overlay • Character Preservation District Overlay • Coastal Areas Overlay • Hazards (Flooding) Overlay • Historic Area Overlay • Local Heritage Place Overlay • Mt Lofty Ranges Catchment (Area 2) Overlay • Native Vegetation Overlay 	None	Clearance from Overhead Powerlines: DTS 1.1 Advertisements [Appearance]: DTS 1.1, 1.3, 1.4 Advertisements [Proliferation of Advertisements]: DTS 2.1, 2.2 Advertisements [Advertising Content]: DTS 3.1 Advertisements [Amenity Content]: DTS 4.1 Advertising [Safety]: DTS 5.1, 5.2, 5.3, 5.4, 5.5	None	Airport Building Heights (Aircraft Landing Area): DTS 1.1 Airport Building Heights (Regulated): DTS 1.1, 1.2 Building Near Airfields: DTS 1.1, 1.2 Defence Aviation Area: DTS 1.1, 1.3 Hazards (Acid Sulfate Soils): DTS 1.1 Future Road Widening: DTS 1.1 Key Outback and Rural Routes: 8.1 Major Urban Transport Routes: 8.1 Native Vegetation: DTS 1.1

Class of Development

The following Classes of Development are classified as Deemed-to-Satisfy Development subject to meeting the 'Deemed-to-Satisfy Development Classification Criteria'

- Non-stop Corridor Overlay
- Ramsar Wetlands Overlay
- River Murray Flood Plain Overlay
- Sloping Land Overlay
- State Heritage Area Overlay
- State Heritage Place Overlay
- State Significant Native Vegetation Overlay

Deemed-to-Satisfy Development Classification Criteria

Provisions referred to are Deemed-to-Satisfy Criteria
 Where a development comprises more than one Class of Development the relevant criteria will be taken to be the sum of the criteria for each Class of Development.

Zone	General Development Policies	Subzone (applies only in the area affected by the Subzone)	Overlay (applies only in the area affected by the Overlay)
-------------	-------------------------------------	--	--

Urban Transport Routes: 8.1

Table 3 – Applicable Policies for Performance Assessed Development

Class of Development	Applicable Policies			
	Zone	General Development Policies	Subzone (applies only in the area affected by the Subzone)	Overlay (applies only in the area affected by the Overlay)
Advertisement	None	Clearance from Overhead Powerlines: PO 1.1 Advertisements [Appearance]: PO 1.1, 1.3, 1.4 Advertisements [Proliferation of Advertisements]: PO 2.1, 2.2 Advertisements [Advertising Content]: PO 3.1 Advertisements [Amenity Content]: PO 4.1 Advertising [Safety]: PO 5.1, 5.2, 5.3, 5.4, 5.5	None	Advertising Near Signalised Intersections: All Airport Building Heights (Aircraft Landing Area): All Airport Building Heights (Regulated): All Building Near Airfields: All Character Area: All Character Preservation District: All Coastal Areas: All Defence Aviation Area: All Future Road Widening: All Hazards (Acid Sulfate Soils): All Hazards (Flooding): All Historic Area: All Key Outback and Rural Routes: All Local Heritage Place: All

Class of Development	Applicable Policies			
	Zone	General Development Policies	Subzone (applies only in the area affected by the Subzone)	Overlay (applies only in the area affected by the Overlay)
				Major Urban Transport Routes: All Mt Lofty Ranges Catchment (Area 2): All Native Vegetation: All Non-stop Corridor: All Ramsar Wetlands: All River Murray Flood Plain: All Sloping Land: All State Heritage Area: All State Heritage Place: All State Significant Native Vegetation: All Urban Transport Routes: All
Demolition of a State or Local Heritage Place	None	None	None	Local Heritage Place: All State Heritage Place: All
Demolition within the Historic Area Overlay or	All	None	None	Historic Area: All State Heritage Area: All

Class of Development	Applicable Policies			
	Zone	General Development Policies	Subzone (applies only in the area affected by the Subzone)	Overlay (applies only in the area affected by the Overlay)
State Heritage Area Overlay				
Tree Damaging Activity	None	None	None	Regulated Trees: All
All other Code Assessed Development	All	All	None	Any Relevant Overlay: All

The following policies are applicable to the assessment of the identified Class of Development. Policies referred to are Performance Outcome policies, and any associated Designated Performance Features. Relevant Desired Outcomes are not listed, but automatically apply in relation to a Performance Assessed Development.

Where a development comprises more than one Class of Development the relevant policies will be taken to be the sum of the applicable policies for each Class of Development.

Table 4 –Restricted Development Classification

Class of Development The following Classes of Development are classified as Restricted subject to any 'Exclusions'	Exclusions
None Specified	

Assessment Provisions

Desired Outcomes (DO)

DO 1

Provision of a range of public and private community, educational, recreational and health care facilities.

Performance Outcomes and Deemed to Satisfy / Designated Performance Outcome Criteria

Land Use and Intensity

PO 1.1

Development is associated with or ancillary to the provision of community, educational, recreational and / or health care services.

DTS/DPF 1.1

Development comprises one or more of the following land uses:

- Consulting room
- Educational establishment
- Indoor recreation facility
- Office
- Place of worship
- Pre-school
- Recreation area
- Shop

PO 1.2

Integration and coordination of adjoining land uses to enhance accessibility and efficiency in service delivery.

DTS/DPF 1.2

None are applicable.

PO 1.3

Development avoids inhibiting or prejudicing future delivery of community, educational, recreational or health care services.

DTS/DPF 1.3

None are applicable.

Built Form and Character

PO 2.1

A range of low to medium rise buildings, with the highest intensity of built form at the centre of the zone and lower scale at the peripheral zone interface.

DTS/DPF 2.1

Building height does not exceed a maximum height specified in the *Building Height Technical and Numeric Variations Overlay*.

Interface Height

PO 3.1

Buildings mitigate visual impacts of building massing on residential development within a neighbourhood zone.

DTS/DPF 3.1

Buildings constructed within a building envelope provided by a 45 degree plane measured from a height of 3 metres above natural ground level at the allotment boundary of a residential allotment within a neighbourhood zone as shown in the following diagram (except where this boundary is a southern boundary in which case DTS/DPF 3.2 will apply, or where this boundary is the primary street boundary):

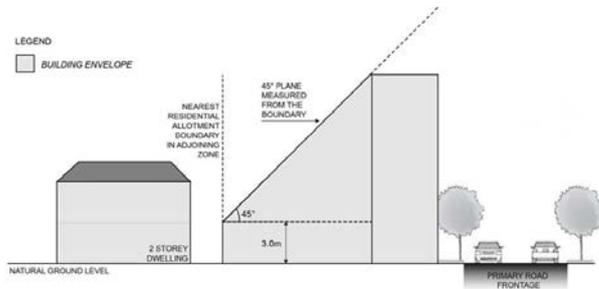

PO 3.2

Buildings mitigate overshadowing of residential development within a neighbourhood zone.

DTS/DPF 3.2

Buildings on sites with a southern boundary adjoining a residential allotment within a neighbourhood zone are constructed within a building envelope provided by a 30 degree plane grading north measured from a height of 3m above natural ground level at the southern boundary, as shown in the following diagram:

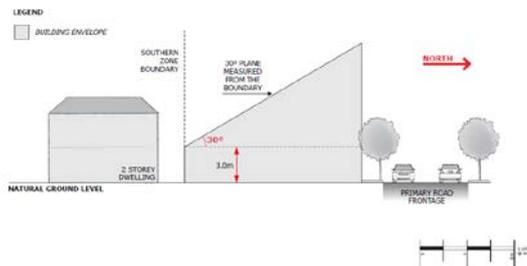

Procedural Matters (PM)

Notification of Performance assessed development

All classes of development are excluded from notification except where it involves any of the following:

- the site of the development is adjacent land to land in a different zone
- development identified as "all other code assessed development" in Community Facilities Zone Table 3

Conservation Zone

Table 1 – Accepted Development Classification

Class of Development The following Classes of Development are classified as Accepted Development subject to meeting the 'Accepted Development Classification Criteria'	Accepted Development Classification Criteria
Building work on railway land	7 Building work is associated with a railway 8 It is situated (or to be situated) on railway land 9 It is required for the conduct or maintenance of railway activities.
Internal building work Except where any of the following apply: <ul style="list-style-type: none"> • A Historic Shipwreck identified in the Historic Shipwrecks Overlay • State Heritage Area Overlay • A State Heritage Place identified in the State Heritage Place Overlay 	1 There will be no increase in the total floor area of the building 2 There will be no alteration to the external appearance of the building.
Private bushfire shelters Except where any of the following apply: <ul style="list-style-type: none"> • Coastal Areas Overlay • Hazards (Acid Sulfate Soils) Overlay • Hazards (Flooding) General Overlay • Historic Area Overlay 	1 The development will not be built, or encroach, on an area that is, or will be, required for a sewerage system or waste control system 2 Primary street setback – at least as far back as the building to which it is ancillary 3 Secondary street setback – at least 900mm from the boundary of the allotment 4 At least 6m from the corner of an allotment which abuts the intersection of two or more roads (other than where a 4m x 4m allotment cut-off is already in place).

- Historic Shipwrecks Overlay
- Local Heritage Place Overlay
- Native Vegetation Overlay
- Ramsar Wetlands Overlay
- River Murray Flood Plain Overlay
- Significant Landscape Protection Overlay
- Sloping Land Overlay
- State Heritage Area Overlay
- State Heritage Place Overlay
- State Significant Native Vegetation Overlay
- Water Resources Overlay

Shade sail

Except where any of the following apply:

- Coastal Areas Overlay
- Hazards (Acid Sulfate Soils) Overlay
- Hazards (Flooding) General Overlay
- Historic Area Overlay
- Historic Shipwrecks Overlay
- Local Heritage Place Overlay
- Native Vegetation Overlay
- Ramsar Wetlands Overlay
- River Murray Flood Plain Overlay
- Significant Landscape Protection Overlay

- 1 The development will not be built, or encroach, on an area that is, or will be, required for a sewerage system or waste control system
- 2 Shade sail consists of permeable material
- 3 The total area of the sail - does not exceed 40m²
- 4 No part of the shade sail will be:
 - (a) 3m above ground or floor level (depending on where it is situated) at any place within 900mm of a boundary of the allotment
 - (b) 5m above ground or floor level (depending on where it is situated) within any other part of the allotment
- 5 Primary street setback – at least as far back as the building line of the building to which it is ancillary
- 6 If any part of the sail will be situated on a boundary of the allotment, the length of sail along a boundary does not exceed 8m
- 7 In a case where any part of the sail or a supporting structure will be situated on a side boundary of the allotment — the length of the sail and any such supporting structure together with all

<ul style="list-style-type: none"> • Sloping Land Overlay • State Heritage Area Overlay • State Heritage Place Overlay • State Significant Native Vegetation Overlay • Water Resources Overlay 	<p>relevant walls or structures located along the boundary will not exceed 45% of the length of the boundary.</p>
<p>Solar photovoltaic panels (roof mounted) Except where any of the following apply:</p> <ul style="list-style-type: none"> • Historic Area Overlay • A Local Heritage Place identified in the Local Heritage Place Overlay • State Heritage Area Overlay • A State Heritage Place identified in the State Heritage Place Overlay 	<ol style="list-style-type: none"> 7 Panels are installed parallel to the roof of a building and with the underside surface of the panel not being more than 100mm above the surface of the roof 8 Panels and associated components do not overhang any part of the roof 9 Does not apply to system with a generating capacity of more than 5MW that is to be connected to the State's power system.
<p>Water tank (above ground) Except where any of the following apply:</p> <ul style="list-style-type: none"> • Character Preservation District Overlay • Coastal Areas Overlay • Hazards (Flooding) Overlay • Historic Area Overlay • Historic Shipwrecks Overlay • Local Heritage Place Overlay • Native Vegetation Overlay • Ramsar Wetlands Overlay • River Murray Flood Plain Overlay • Significant Landscape Protection Overlay 	<ol style="list-style-type: none"> 15 The development will not be built, or encroach, on an area that is, or will be, required for a sewerage system or waste control system 16 The tank is part of a roof drainage system 17 Total floor area - not exceeding 15m² 18 The tank is located wholly above ground 19 Tank height – does not exceed 4m above natural ground level 20 Primary street setback – at least as far back as the building line of the building to which it is ancillary 21 In the case of a tank made of metal – the tank is pre-colour treated or painted in a non-reflective colour.

- Sloping Land Overlay
- State Heritage Area Overlay
- State Heritage Place Overlay
- State Significant Native Vegetation Overlay
- Water Resources Overlay

Water tank (underground)

Except where any of the following apply:

- Character Preservation District Overlay
- Coastal Areas Overlay
- Hazards (Acid Sulfate Soils) Overlay
- Historic Shipwrecks Overlay
- Native Vegetation Overlay
- Ramsar Wetlands Overlay
- Sloping Land Overlay
- State Significant Native Vegetation Overlay
- Water Resources Overlay

- 5 The development will not be built, or encroach, on an area that is, or will be, required for a sewerage system or waste control system
- 6 The tank (including any associated pump) is located wholly below the level of the ground.

Table 2 - Deemed-to-Satisfy Development Classification

Development Type The following Classes of Development are classified as Deemed-to-Satisfy Development subject to meeting the 'Deemed-to-Satisfy Development Classification Criteria'	Relevant Requirements Provisions referred to are Deemed-to-Satisfy Criteria Where a development comprises more than one Class of Development the relevant criteria will be taken to be the sum of the criteria for each Class of Development.			
	Zone	General Development Policies	Subzone (applies only in the area affected by the Subzone)	Overlay (applies only in the area affected by the Overlay)
Advertisement Except where any of the following apply: <ul style="list-style-type: none"> Advertising Near Signalised Intersections Overlay Character Preservation District Overlay Coastal Areas Overlay Hazards (Flooding) General Overlay Historic Area Overlay Local Heritage Place Overlay Non-stop Corridor Overlay Ramsar Wetlands Overlay River Murray Flood Plain Overlay Significant Landscape Protection Overlay Sloping Land Overlay State Heritage Area Overlay State Heritage Place Overlay Water Resources Overlay 	[Advertisement]: DTS 6.1, 6.2	Clearance from Overhead Powerlines: DTS 1.1 Advertisements [Appearance]: DTS 1.1, 1.3, 1.4 Advertisements [Proliferation of Advertisements]: DTS 2.1, 2.2 Advertisements [Advertising Content]: DTS 3.1 Advertisements [Amenity Content]: DTS 4.1 Advertisements [Safety]: DTS 5.1, 5.2, 5.3, 5.4, 5.5	None	Airport Building Heights (Aircraft Landing Area): DTS 1.1 Airport Building Heights (Regulated): DTS 1.1, 1.2 Building Near Airfields: DTS 1.1 Defence Aviation Area: DTS 1.1, 1.3 Hazards (Acid Sulfate Soils): DTS 1.1 Historic Shipwrecks: DTS 1.1 Key Outback and Rural Route Overlay: DTS 8.1, 10.1 Major Transport Routes: DTS 8.1, DTS 10.1 Native Vegetation: DTS 1.1, 1.2 State Significant Native Vegetation: DTS 1.1 Urban Transport Routes: DTS 8.1, 10.1

Table 3 – Applicable Policies for Performance Assessed Development

Development Type	Applicable Policies The following policies are applicable to the assessment of the identified Class of Development. Policies referred to are Performance Outcome policies, and any associated Designated Performance Features. Relevant Desired Outcomes are not listed, but automatically apply in relation to a Performance Assessed Development. Where a development comprises more than one Class of Development the relevant policies will be taken to be the sum of the applicable policies for each Class of Development.			
	Zone	General Development Policies	Subzone (applies only in the area affected by the Subzone)	Overlay (applies only in the area affected by the Overlay)
Advertisement	[Advertisement]: PO 6.1, 6.2	Advertisements [Appearance]: PO 1.1, 1.3, 1.4, 1.5 Advertisements [Proliferation of Advertisements]: PO 2.1, 2.2 Advertisements [Advertising Content]: PO 3.1 Advertisements [Amenity Content]: PO 4.1	None	Advertising Near Signalised Intersections: All Airport Building Heights (Aircraft Landing Area): PO 1.1 Airport Building Heights (Regulated): PO 1.1, 1.2

		<p>Advertisements [Safety]: PO 5.1, 5.2, 5.3, 5.4, 5.5</p> <p>Clearance from Overhead Powerlines: PO 1.1</p>		<p>Building Near Airfields: PO 1.1</p> <p>Character Preservation District: All</p> <p>Coastal Areas: All</p> <p>Defence Aviation Area: PO 1.1, 1.3</p> <p>Hazards (Acid Sulfate Soils): PO 1.1</p> <p>Hazards (Flooding) General: All</p> <p>Historic Area: All</p> <p>Historic Shipwrecks: PO 1.1</p> <p>Key Outback and Rural Route: PO 8.1, 10.1</p> <p>Local Heritage Place: All</p> <p>Major Transport Routes: PO 8.1, DTS 10.1</p> <p>Native Vegetation: PO 1.1, 1.2</p> <p>Non-stop Corridor: All</p> <p>Ramsar Wetlands: All</p> <p>River Murray Flood Plain: All</p> <p>Significant Landscape Protection: All</p> <p>Sloping Land: All</p> <p>State Heritage Area: All</p> <p>State Heritage Place: All</p> <p>State Significant Native Vegetation: PO 1.1</p> <p>Urban Transport Routes: PO 8.1, 10.1</p> <p>Water Resources: All</p>
<p>Agricultural building</p> <p>Except where any of the following apply:</p> <ul style="list-style-type: none"> • Dwelling Subzone • Small Scale Settlement Subzone • Visitor Experience Subzone 	<p>[Land Use] PO 1.1, 1.3</p> <p>[Environmental Protection]: PO 3.1</p> <p>[Built Form and Character]: PO 4.1, 4.2, 4.4</p> <p>[Access and Car Parking]: PO 5.1, 5.2, 5.6</p>	<p>Clearance from Overhead Powerlines: PO 1.1</p> <p>Infrastructure and Renewable Energy Facilities [Wastewater Services]: PO 12.2</p> <p>Interface between Land Uses [Activities Generating Noise or Vibration]: PO 4.1</p> <p>Transport, Access and Parking [Movement Systems]: PO 1.4</p> <p>Transport, Access and Parking [Vehicle Access]: PO 3.1</p>	<p>Visitor Experience Subzone: All</p> <p>Dwelling Subzone: All</p> <p>Small-scale settlement Subzone: All</p> <p>Aquaculture and Recreation Subzone: All</p>	<p>Airport Building Heights (Aircraft Landing Area): All</p> <p>Airport Building Heights (Regulated): All</p> <p>Building Near Airfields: PO 1.1</p> <p>Character Preservation District: All</p> <p>Coastal Areas: All</p> <p>Defence Aviation Area: PO 1.1, 1.3</p> <p>Hazards (Acid Sulfate Soils): All</p> <p>Hazards (Bushfire - General Risk): PO 1.1, 2.1, 2.2</p> <p>Hazards (Bushfire - High Risk): PO 2.1, 3.1, 3.2</p> <p>Hazards (Bushfire - Medium Risk): PO 1.1, 2.1, 2.2</p> <p>Hazards (Bushfire - Regional): PO 1.1, 2.1, 2.2</p> <p>Hazards (Flooding): PO 2.1, 2.2, 2.3, 2.4, 3.1, 3.2, 4.1, 4.2</p> <p>Historic Area: All</p> <p>Historic Shipwrecks: All</p> <p>Key Outback and Rural Routes: All</p> <p>Key Railway Crossings: All</p> <p>Local Heritage Place: All</p> <p>Major Urban Transport Routes: All</p>

				<p>Marine Parks (Managed Use): All</p> <p>Marine Parks (Restricted Use): All</p> <p>Mt Lofty Ranges Catchment (Area 1): All</p> <p>Mt Lofty Ranges Catchment (Area 2): All</p> <p>Native Vegetation: All</p> <p>Ramsar Wetlands: All</p> <p>River Murray Flood Plain: All</p> <p>Significant Landscape Protection: All</p> <p>Sloping Land: All</p> <p>State Heritage Area: All</p> <p>State Heritage Place: All</p> <p>State Significant Native Vegetation: All</p> <p>Water Protection Area: All</p> <p>Water Resources: All</p>
Demolition of a State or Local Heritage Place	None	None	None	<p>Local Heritage Place: All</p> <p>State Heritage Place: All</p>
Demolition within an Historic Areas Overlay area or State Heritage Area	None	None	None	<p>Historic Area: All</p> <p>State Heritage Area: All</p>
<p>Dwelling</p> <p>Where any of the following apply:</p> <ul style="list-style-type: none"> Dwelling Subzone Small Scale Settlement Subzone 	<p>[Land use]: PO 1.1</p> <p>[Built Form and Character]: PO 4.1, 4.2, 4.4</p> <p>[Hazard Risk Minimisation]: PO 8.1</p>	<p>Clearance from Overhead Powerlines: PO 1.1</p> <p>Design in Rural Areas [All Development - On-site Waste Treatment Systems]: PO 6.1</p> <p>Design in Rural Areas [All Residential Development – External Appearance]: PO 10.1, 10.2</p> <p>Design in Rural Areas [All Residential Development - Outlook and Amenity] PO 11.1</p> <p>Design in Rural Areas [All Residential Development - Access and Servicing]: PO 12.1</p> <p>Design in Rural Areas [Residential Development – 3 Building Levels or Less – External Appearance]: PO 14.1, 14.2, 14.3</p> <p>Design in Rural Areas [Residential Development – 3 Building Levels or Less – Car Parking, Access and Manoeuvrability]: PO 18.3, 18.4, 18.5</p> <p>Design in Rural Areas [Design of Transportable Dwellings]: PO 20.1</p> <p>Infrastructure and Renewable Energy Facilities [Water Supply]: PO 11.2</p> <p>Infrastructure and Renewable Energy Facilities [Wastewater Services]: PO 12.1, 12.2</p> <p>Infrastructure and Renewable Energy Facilities [Water Supply]: PO 11.1</p> <p>Infrastructure and Renewable Energy Facilities [Wastewater Services]: PO 12.1, 12.2</p> <p>Interface Between Land Uses [Interface Between Rural Activities]: PO 9.6. 9.7</p>	<p>Dwelling Subzone: All</p> <p>Small-scale settlement Subzone: All</p>	<p>Airport Building Heights (Aircraft Landing Area): All</p> <p>Airport Building Heights (Regulated): All</p> <p>Building Near Airfields: All</p> <p>Coastal Areas: All</p> <p>Defence Aviation Area: All</p> <p>Hazards (Acid Sulfate Soils): All</p> <p>Hazards (Bushfire - General Risk): All</p> <p>Hazards (Bushfire - High Risk): All</p> <p>Hazards (Bushfire - Medium Risk): All</p> <p>Hazards (Bushfire – Outback): All</p> <p>Hazards (Bushfire - Regional): All</p> <p>Hazards (Bushfire – Urban Interface): All</p> <p>Hazards (Flooding): All</p> <p>Historic Area: All</p> <p>Historic Shipwrecks: All</p> <p>Key Outback and Rural Routes: All</p> <p>Key Railway Crossings: All</p> <p>Local Heritage Place: All</p> <p>Major Urban Transport Routes: All</p> <p>Marine Parks (Managed Use): All</p>

		<p>Interface Between Land Uses [Interface with Mines and Quarries (Rural and Remote Areas): PO 10.1</p> <p>Site Contamination: PO 1.1</p> <p>Transport, Access and Parking [Vehicle Access]: PO 3.1, 3.5, 3.6</p>		<p>Marine Parks (Restricted Use): All</p> <p>Mt Lofty Ranges Catchment (Area 1): All</p> <p>Mt Lofty Ranges Catchment (Area 2): All</p> <p>Murray Darling Basin: All</p> <p>Native Vegetation: All</p> <p>Noise and Air Emissions: All</p> <p>Non-stop Corridor: All</p> <p>Prescribed Water Resources Area: All</p> <p>Prescribed Watercourses: All</p> <p>Prescribed Wells Area: All</p> <p>Ramsar Wetlands: All</p> <p>Resource Extraction Protection Area: All</p> <p>River Murray Flood Plain: All</p> <p>River Murray Tributaries Area: All</p> <p>Significant Landscape Protection: All</p> <p>Sloping Land: All</p> <p>State Heritage Area: All</p> <p>State Heritage Place: All</p> <p>State Significant Native Vegetation: All</p> <p>Strategic Infrastructure (Gas Pipelines): PO 2.1</p> <p>Urban Transport Routes: All</p> <p>Water Protection Area: All</p> <p>Water Resources: All</p>
Dwelling addition	<p>[Built Form and Character]: PO 4.1, 4.2, 4.4</p> <p>[Hazard Risk Minimisation]: PO 8.1</p>	<p>Clearance from Overhead Powerlines: PO 1.1</p> <p>Design in Rural Areas [All Development - On-site Waste Treatment Systems]: PO 6.1</p> <p>Design in Rural Areas [All Residential Development – External Appearance]: PO 10.1</p>	<p>Visitor Experience Subzone: All</p> <p>Dwelling Subzone: All</p> <p>Small-scale settlement Subzone: All</p> <p>Aquaculture and Recreation Subzone: All</p>	<p>Airport Building Heights (Aircraft Landing Area): All</p> <p>Airport Building Heights (Regulated): All</p> <p>Building Near Airfields: PO 1.3</p> <p>Character Preservation District: PO 3.1, 3.2, 3.3, 3.4, 4.1</p> <p>Coastal Areas [Hazard Risk Minimisation] [Environment Protection]: All</p> <p>Defence Aviation Area: PO 1.1</p> <p>Hazards (Acid Sulfate Soils): All</p> <p>Hazards (Bushfire - High Risk): All</p> <p>Hazards (Bushfire - Medium Risk): All</p> <p>Hazards (Bushfire - General Risk): All</p>

				<p>Hazards (Bushfire – Urban Interface): All</p> <p>Hazards (Bushfire – Outback): All</p> <p>Hazards (Bushfire - Regional): All</p> <p>Hazards (Flooding): PO 3.1, 3.2, 3.3, 3.4, 4.1, 5.1, 5.2</p> <p>Historic Area: PO 2.1, 2.2</p> <p>Historic Shipwrecks: All</p> <p>Local Heritage Place: All</p> <p>Marine Parks (Managed Use): All</p> <p>Marine Parks (Restricted Use): All</p> <p>Mt Lofty Ranges Catchment (Area 1): All</p> <p>Mt Lofty Ranges Catchment (Area 2): All</p> <p>Native Vegetation: All</p> <p>Noise and Air Emissions: All</p> <p>Ramsar Wetlands: All</p> <p>Resource Extraction Protection Area: All</p> <p>River Murray Flood Plain: All</p> <p>Significant Landscape Protection: All</p> <p>Sloping Land: All</p> <p>State Heritage Area: All</p> <p>State Heritage Place: All</p> <p>State Significant Native Vegetation: All</p> <p>Water Resources: All</p>
<p>Farming</p> <p>Except where any of the following apply:</p> <ul style="list-style-type: none"> • Dwelling Subzone • Small Scale Settlement Subzone • Visitor Experience Subzone 	<p>[Land Use]: PO 1.1, 1.3</p> <p>[Environmental Protection]: PO 3.1</p>	None	None	<p>Character Preservation District: All</p> <p>Coastal Areas Overlay: All</p> <p>Historic Area: All</p> <p>Historic Shipwrecks: All</p> <p>Local Heritage Place: All</p> <p>Marine Parks (Managed Use): All</p> <p>Marine Parks (Restricted Use): All</p> <p>Mt Lofty Ranges Catchment (Area 1): All</p> <p>Mt Lofty Ranges Catchment (Area 2): All</p> <p>Native Vegetation: All</p> <p>Ramsar Wetlands: All</p> <p>River Murray Flood Plain: All</p> <p>Significant Landscape Protection: All</p> <p>Sloping Land: All</p> <p>State Heritage Area: All</p> <p>State Heritage Place: All</p> <p>State Significant Native Vegetation: All</p> <p>Water Protection Area: All</p> <p>Water Resources: All</p>
Land division	<p>[Land Division]: PO 2.1</p> <p>[Environmental Protection]: PO 3.1</p>	Land Division in Rural Areas: All	<p>Visitor Experience Subzone: All</p> <p>Dwelling Subzone: All</p>	<p>Character Preservation District: All</p> <p>Coastal Areas: PO 1.1, 1.2, 1.3</p> <p>Environment and Food Production Area: All</p>

			<p>Small-scale settlement Subzone: All</p> <p>Aquaculture and Recreation Subzone: All</p>	<p>Hazards (Bushfire - General Risk) [Land Division]: All</p> <p>Hazards (Bushfire - High Risk) [Land Division]: All</p> <p>Hazards (Bushfire - Medium Risk) [Land Division]: All</p> <p>Hazards (Bushfire - Regional) [Land Division]: All</p> <p>Hazards (Bushfire – Urban Interface) [Land Division]: All</p> <p>Hazards (Flooding) [Land Division]: All</p> <p>Historic Area: PO 4.1</p> <p>Key Outback and Rural Routes: All</p> <p>Local Heritage Place: PO 4.1</p> <p>Major Urban Transport Routes: All</p> <p>Marine Parks (Managed Use): All</p> <p>Marine Parks (Restricted Use): All</p> <p>Mt Lofty Ranges Catchment (Area 1): PO 5.1, 5.2</p> <p>Mt Lofty Ranges Catchment (Area 2): 5.1, 5.2</p> <p>Native Vegetation: 2.1</p> <p>Non-stop Corridor: All</p> <p>Ramsar Wetlands: 2.1</p> <p>Regulated Trees: 3.1</p> <p>Resource Extraction Protection Area: All</p> <p>River Murray Flood Plain: PO 2.1, 2.2</p> <p>River Murray Tributaries Area: 2.1, 2.2</p> <p>Sloping Land: All</p> <p>State Heritage Area: PO 4.1</p> <p>State Heritage Place: PO 4.1</p> <p>State Significant Native Vegetation: PO 2.1</p> <p>Strategic Infrastructure (Gas Pipelines): PO 1.1</p> <p>Traffic Generating Development: All</p> <p>Urban Transport Routes: All</p> <p>Water Resources: All</p>
<p>Tourist accommodation</p> <p>Where any of the following apply:</p> <ul style="list-style-type: none"> • Visitor Experience Subzone • In an area proclaimed under the <i>National Parks and Wildlife Act 1972</i> and is contemplated by the relevant ‘management plan’ prepared in accordance with that Act. 	<p>[Land Use]: PO 1.1, 1.2</p> <p>[Environmental Protection]: PO 3.1</p> <p>[Built Form and Character]: PO 4.1, 4.2, 4.4</p> <p>[Access and Car Parking]: PO 5.1, 5.2, 5.3</p>	<p>Design in Rural Areas [All Development – External Appearance]: PO 1.4, 1.5</p> <p>Design in Rural Areas [All Development – Landscaping]: PO 3.1</p> <p>Design in Rural Areas [All Development – Water Sensitive Design]: PO 5.1</p> <p>Design in Rural Areas [All Development – On-site Waste Treatment Systems]: DTS 6.1</p> <p>Design in Rural Areas [All Development – Vehicle Parking Areas]: PO 7.4, 7.5</p>	<p>Visitor Experience Subzone: All</p>	<p>Airport Building Heights (Aircraft Landing Area): All</p> <p>Airport Building Heights (Regulated): All</p> <p>Building Near Airfields: All</p> <p>Coastal Areas: All</p> <p>Defence Aviation Area: All</p> <p>Hazards (Acid Sulfate Soils): All</p>

<ul style="list-style-type: none"> In an area proclaimed under the <i>Wilderness Protection Act 1992</i> and is contemplated by the relevant 'plan of management' prepared in accordance with that Act. 		<p>Design in Rural Areas [All Development – Earthworks]: PO 8.1</p> <p>Infrastructure and Renewable Energy Facilities [Water Supply]: PO 11.1</p> <p>Infrastructure and Renewable Energy Facilities [Wastewater Services]: PO 12.1</p> <p>Interface between Land Uses [Interface with Rural Activities]: PO 9.1, 9.2, 9.3, 9.4, 9.5</p> <p>Interface between Land Uses [Interface with Mines and Quarries (Rural and Remote Areas)]: PO 10.1</p> <p>Site Contamination: All</p> <p>Tourism Development: All</p> <p>Transport, Access and Parking [Movement Systems]: PO 1.4</p> <p>Transport, Access and Parking [Vehicle Access]: PO 3.1, 3.3, 3.5</p> <p>Transport, Access and Parking [Vehicle Parking Rates]: PO 5.1</p> <p>Transport, Access and Parking [Vehicle Parking Areas]: PO 6.1, 6.6</p>	<p>Hazards (Bushfire - General Risk): All</p> <p>Hazards (Bushfire - High Risk): All</p> <p>Hazards (Bushfire - Medium Risk): All</p> <p>Hazards (Bushfire – Outback): All</p> <p>Hazards (Bushfire - Regional): All</p> <p>Hazards (Bushfire – Urban Interface): All</p> <p>Hazards (Flooding): All</p> <p>Historic Area: All</p> <p>Historic Shipwrecks: All</p> <p>Key Outback and Rural Routes: All</p> <p>Key Railway Crossings: All</p> <p>Local Heritage Place: All</p> <p>Major Urban Transport Routes: All</p> <p>Marine Parks (Managed Use): All</p> <p>Marine Parks (Restricted Use): All</p> <p>Mt Lofty Ranges Catchment (Area 1): All</p> <p>Mt Lofty Ranges Catchment (Area 2): All</p> <p>Murray Darling Basin: All</p> <p>Native Vegetation: All</p> <p>Noise and Air Emissions: All</p> <p>Non-stop Corridor: All</p> <p>Prescribed Water Resources Area: All</p> <p>Prescribed Watercourses: All</p> <p>Prescribed Wells Area: All</p> <p>Ramsar Wetlands: All</p> <p>Resource Extraction Protection Area: All</p> <p>River Murray Flood Plain: All</p> <p>River Murray Tributaries Area: All</p> <p>Significant Landscape Protection: All</p> <p>Sloping Land: All</p> <p>State Heritage Area: All</p> <p>State Heritage Place: All</p> <p>State Significant Native Vegetation: All</p> <p>Strategic Infrastructure (Gas Pipelines): PO 2.1</p> <p>Urban Transport Routes: All</p>
--	--	--	--

				Water Protection Area: All Water Resources: All
Tree damaging activity	None	None	None	Regulated Tree: All
All other Code Assessed Development	All	All	Any Relevant Subzone: All	Any Relevant Overlay: All

Table 4 –Restricted Development Classification

Class of Development The following Classes of Development are classified as Restricted subject to any 'Exclusions'	Exclusions
Dwelling	Detached dwelling in the Dwelling Subzone where it will not result in more than one dwelling per allotment. In the Small-scale Settlement Subzone .
Land division	Where Conservation Zone DTS / DPF 2.1 is met. In the Visitor Experience Subzone to create an allotment with an area of 5ha or more for existing tourist accommodation. In the Small Scale Settlement Subzone .
Tourist Accommodation	In the Visitor Experience Subzone . In an area proclaimed under the <i>National Parks and Wildlife Act 1972</i> and is contemplated by the relevant 'management plan' prepared in accordance with that Act. In an area proclaimed under the <i>Wilderness Protection Act 1992</i> and is contemplated by the relevant 'plan of management' prepared in accordance with that Act.

Assessment Provisions (AP)

Desired Outcome (DO)

DO 1

The conservation and enhancement of the natural environment and natural ecological processes for their historic, scientific, landscape, faunal habitat, biodiversity and cultural values and provision of opportunities for the public to experience these through low-impact recreational and tourism development.

Performance Outcomes and Deemed to Satisfy / Designated Performance Outcome Criteria

Land Use

PO 1.1

Small-scale, low-impact land uses that provide for the conservation and protection of the area, while allowing the public to experience these important environmental assets.

DTS/DPF 1.1

Development comprises one or more of the following land uses:

- Advertisement
- Camp ground
- Farming
- Public amenity
- Renewable energy facility

PO 1.2

Development primarily in the form of:

- (a) directional, identification and/or interpretative advertisements and/or advertising hoardings for conservation management and tourist information purposes;
- (b) scientific monitoring structures or facilities;
- (c) small-scale facility associated with the interpretation and appreciation of natural and cultural heritage such as public amenities, camping grounds, remote shelters or huts; or
- (d) structures for conservation management purposes.

DTS 1.2

None are applicable.

PO 1.3

Farming activities occur on already cleared land and outside of areas containing native vegetation, coastal dunes and wetlands of national importance.

DTS 1.3

None are applicable.

Land Division

PO 2.1

Land division supports the management or improvement of the natural environment and does not result in any additional allotments, nor allotments with frontage or access to the coast.

DTS/DPF 2.1

Land division that does not create any additional allotments, nor any additional allotments with frontage or direct access to the coast and is for the:

- (a) creation of a public road or a public reserve; or
- (b) minor adjustment of allotment boundaries to remove an anomaly in existing boundaries with respect to the location of existing buildings or structures

Environmental Protection

PO 3.1

Development avoids important nesting or breeding areas or areas that are important for the movement/migration patterns of fauna.

DTS 3.1

None are applicable.

Built Form and Character

PO 4.1

Development sited and designed unobtrusively to minimise the visual impact on the natural environment by:

- (a) using low reflective materials and finishes that blend with, and colours that complement, the surrounding landscape;
- (b) being located below hilltops and ridgelines; and
- (c) being screened by existing vegetation.

DTS 4.1

None are applicable.

PO 4.2

Development sited and designed to minimise impacts on the natural environment by:

- (a) containing construction and built form within a tightly defined site boundary; and
- (b) minimising the extent of earthworks.

DTS 4.2

None are applicable.

PO 4.3

Recreation or visitor facilities located in publicly accessible areas in proximity to recreation trails to minimise impact on the natural environment.

DTS 4.3

None are applicable.

PO 4.4

Development does not obscure existing public views to landscape, river or seascape features and is not visibly prominent from key public vantage points, including public roads or car parking areas.

DTS 4.4

None are applicable.

Access and Car Parking

PO 5.1

Vehicle access points are limited to minimise impact on the natural environment.

DTS/DPF 5.1

No more than one vehicle access point is provided to a site, landmark or lookout.

PO 5.2

Roads and vehicle access ways are located to minimise vegetation clearance and are constructed of permeable materials.

DTS 5.2

None are applicable.

PO 5.3

Roads are of a width and route to encourage low speeds and to minimise impact on the natural environment.

DTS 5.3

None are applicable.

PO 5.4

Recreational trails and access ways located to direct the public away from sensitive areas to minimise impact on the natural environment.

DTS 5.4

None are applicable.

PO 5.5

Recreational trails are raised or surfaced with permeable materials to minimise impact on the natural environment.

DTS/DPF 5.5

Pedestrian access ways/Recreational trails are raised or constructed of permeable materials.

PO 5.6

Car parking areas designed to minimise impact on the natural environment.

DTS/DPF 5.6

Car parking areas:

- (a) are constructed of permeable material; and
- (b) are located on already legally cleared land; and
- (c) are consolidated in one location.

Advertisement

PO 6.1

Advertisements limited to those needed for direction, identification and/or interpretation of environmental or cultural values and recreational and tourism facilities.

DTS/DPF 6.1

Advertisements are for one or more of the following:

- (a) direction;
- (b) identification and interpretation of environmental values; or
- (c) identification of recreational and tourism facilities.

PO 6.2

Advertisements limited in number and size to minimise impact on the visual and natural environment.

DTS/DPF 6.2

Total combined area of advertisement(s) is not greater than 2m² on any one site.

Landscaping

PO 7.1

Screening and planting is provided to buildings and structures and comprises locally indigenous species to enhance the natural environment.

DTS 7.1

None are applicable.

Hazard Risk Minimisation

PO 8.1

Habitable buildings designed and sited to manage the risks of natural hazards on personal and public safety and property.

DTS 8.1

None are applicable.

Concept Plans

PO 9.1

Development is compatible with the outcomes sought by any relevant Concept Plan contained within the *Concept Plans Technical and Numeric Variation Overlay*

DTS 9.1

None are applicable

Procedural Matters (PM)

Notification

All classes of performance assessed development is excluded from notification except where they involve any of the following:

- (a) the site of the development is adjacent to land in a different zone
- (b) development identified as "all other code assessed development" in Conservation Zone Table 3.

Placement of Notices – Exemptions for Performance Assessed Development

None specified.

Placement of Notices – Exemptions for Restricted Development

None specified.

Coastal Waters and Offshore Islands Zone

Table 1 – Accepted Development Classification

Class of Development The following Classes of Development are classified as Accepted Development subject to meeting the 'Accepted Development Classification Criteria'	Accepted Development Classification Criteria
Building work on railway land	1 Building work is associated with a railway 2 It is situated (or to be situated) on railway land 3 It is required for the conduct or maintenance of railway activities.
Carport Except where any of the following apply: <ul style="list-style-type: none"> • Coastal Areas Overlay • Hazards (Acid Sulfate Soils) Overlay • Hazards (Flooding) Overlay • Historic Area Overlay • Historic Shipwrecks Overlay • Local Heritage Place Overlay • State Heritage Place Overlay • Native Vegetation Overlay 	14 The development will not be built, or encroach, on an area that is, or will be, required for a sewerage system or waste control system 15 It is ancillary to a dwelling erected on the site 16 Primary street setback – at least 5.5m from the primary street boundary and as far back as the building line of the building to which it is ancillary 17 Secondary street setback – at least 900mm from the boundary of the allotment (if the land has boundaries on two or more roads) 18 Total floor area - does not exceed 40m ² 19 Post height - does not exceed 3m measured from natural ground level (and not including a gable end) 20 Building height - does not exceed 5m 21 If situated on or abutting a boundary (not being a boundary with a primary street or secondary street) – a length not exceeding 10m unless: <ul style="list-style-type: none"> (a) a longer wall or structure exists on the adjacent site and is situated on the same allotment boundary; and (b) the proposed wall or structure will be built along the same length of boundary as the existing adjacent wall or structure to the same or lesser extent

<ul style="list-style-type: none"> • State Significant Native Vegetation Overlay • Ramsar Wetlands Overlay • River Murray Flood Plain Overlay • Sloping Land Overlay • Key Outback and Rural Routes Overlay where an existing access is altered or a new access is created • Major Urban Transport Routes Overlay where an existing access is altered or a new access is created • Non-stop Corridor Overlay where an existing access is altered or a new access is created • Urban Transport Routes Overlay where an existing access is altered or a new access is created • Water Resources Overlay 	<p>22 If the carport abuts or is situated on the boundary of the allotment (not being a boundary with a primary street or secondary street):</p> <p>(a) it will not result in all relevant walls or structures located along the boundary exceeding 45% of the length of the boundary; and</p> <p>(b) it will not be located within 3m of any other wall along the same boundary unless on an adjacent site on that boundary there is an existing wall of a building that would be adjacent to or abut the proposed wall or structure</p> <p>23 The total roofed area of all existing or proposed buildings on the allotment does not exceed 70% of the area of the allotment</p> <p>24 Door opening for vehicle access – does not exceed, in total, 7m in width or 50% of the width of the allotment frontage (whichever lesser)</p> <p>25 Internal dimensions – does not exceed 3.2m in width and 6m in length between all fences, walls and doors</p> <p>26 The carport:</p> <p>(a) is located so that vehicle access:</p> <ul style="list-style-type: none"> i. is provided via a lawfully existing or authorised driveway or access point or an access point for which consent has been granted as part of an application for the division of land; or ii. will use a driveway that: <ul style="list-style-type: none"> A. is not located within 6 metres of an intersection of 2 or more roads or a pedestrian actuated crossing; and B. will not interfere with an item of street furniture (including directional signs, lighting, seating and weather shelters), other infrastructure, or a tree; or iii. if adjacent a kerbed road, will be via a kerb that is designed to allow a vehicle to roll over it; and <p>(b) is located so that the gradient from the place of access on the boundary of the allotment to the finished floor level at the front of the carport when the work is completed is not steeper than 1:4 on average; and</p> <p>(c) the centre of the driveway at the public road boundary is no more than 25 degree deviation from the centre of the front of the covered car parking space for which it provides vehicle access.</p>
<p>Internal building work</p>	<p>1 There will be no increase in the total floor area of the building</p>

Except where any of the following apply:

- ~~Historic Area Overlay~~
- A Local Heritage Place identified in the Local Heritage Place Overlay
- A Historic Shipwreck identified in the Historic Shipwrecks Overlay
- A Local Heritage Place identified in the Local Heritage Place Overlay
- A State Heritage Place identified in the State Heritage Place Overlay

2 There will be no alteration to the external appearance of the building.

Outbuilding (in the form of a garage)

Except where any of the following apply:

- Coastal Areas Overlay
- Hazards (Acid Sulfate Soils) Overlay
- Hazards (Flooding) Overlay
- Historic Area Overlay
- Historic Shipwrecks Overlay
- Local Heritage Place Overlay
- State Heritage Place Overlay
- Native Vegetation Overlay
- State Significant Native Vegetation Overlay
- Ramsar Wetlands Overlay
- River Murray Flood Plain Overlay
- Sloping Land Overlay
- Key Outback and Rural Routes Overlay where an existing access is altered or a new access is created

- 15 The development will not be built, or encroach, on an area that is, or will be, required for a sewerage system or waste control system
- 16 It is detached from and ancillary to a dwelling erected on the site.
- 17 Primary street setback – at least 5.5m from the primary street boundary and as far back as the building line of the building to which it is ancillary
- 18 Secondary street setback – at least 900mm from the boundary of the allotment (if the land has boundaries on two or more roads)
- 19 Total floor area - does not exceed 40m²
- 20 Wall height - does not exceed 3m measured from natural ground level (and not including a gable end)
- 21 Building height - does not exceed 5m
- 22 If situated on or abutting a boundary (not being a boundary with a primary street or secondary street) – a length not exceeding 10m unless:
 - (a) a longer wall or structure exists on the adjacent site and is situated on the same allotment boundary; and
 - (b) the proposed wall or structure will be built along the same length of boundary as the existing adjacent wall or structure to the same or lesser extent
- 23 If the outbuilding abuts or is situated on the boundary of the allotment (not being a boundary with a primary street or secondary street):
 - (a) it will not result in all relevant walls or structures located along the boundary exceeding 45% of the length of the boundary; and

<ul style="list-style-type: none"> • Major Urban Transport Routes Overlay where an existing access is altered or a new access is created • Non-stop Corridor Overlay where an existing access is altered or a new access is created • Urban Transport Routes Overlay where an existing access is altered or a new access is created • Water Resources Overlay 	<p>(b) it will not be located within 3m of any other wall along the same boundary unless on an adjacent site on that boundary there is an existing wall of a building that would be adjacent to or abut the proposed wall or structure</p> <p>24 Total roofed area of all existing and proposed buildings on the allotment - does not exceed 60%</p> <p>25 Internal dimensions – exceed 3.2m in width and 6m in length between all walls and doors</p> <p>26 Door opening for vehicle access – does not exceed, in total, 7m in width or 50% of the width of the allotment frontage (whichever lesser)</p> <p>27 The garage:</p> <p>(a) is located so that vehicle access:</p> <ul style="list-style-type: none"> i. is provided via a lawfully existing or authorised driveway or access point or an access point for which consent has been granted as part of an application for the division of land; or ii. will use a driveway that: <ul style="list-style-type: none"> A. is not located within 6 metres of an intersection of 2 or more roads or a pedestrian actuated crossing; and B. will not interfere with an item of street furniture (including directional signs, lighting, seating and weather shelters), other infrastructure, or a tree; or iii. if adjacent a kerbed road, will be via a kerb that is designed to allow a vehicle to roll over it; and <p>(b) is located so that the gradient from the place of access on the boundary of the allotment to the finished floor level at the front of the carport when the work is completed is not steeper than 1:4 on average; and</p> <p>(c) the centre of the driveway at the public road boundary is no more than 25 degree deviation from the centre of the front of the covered car parking space for which it provides vehicle access</p> <p>28 If clad in sheet metal—is pre-colour treated or painted in a non-reflective colour.</p>
<p>Outbuilding (not being a garage)</p> <p>Except where any of the following apply:</p> <ul style="list-style-type: none"> • Coastal Areas Overlay 	<p>13 The development will not be built, or encroach, on an area that is, or will be, required for a sewerage system or waste control system</p> <p>14 It is detached from and ancillary to a dwelling erected on the site</p> <p>15 Primary street setback – at least as far back as the building line of the building to which it is ancillary</p>

<ul style="list-style-type: none"> • Hazards (Acid Sulfate Soils) Overlay • Hazards (Flooding) Overlay • Historic Area Overlay • Historic Shipwrecks Overlay • Local Heritage Place Overlay • State Heritage Place Overlay • Native Vegetation Overlay • State Significant Native Vegetation Overlay • Ramsar Wetlands Overlay • River Murray Flood Plain Overlay • Sloping Land Overlay • Water Resources Overlay 	<p>16 Secondary street setback – at least 900mm from the boundary of the allotment (if the land has boundaries on two or more roads)</p> <p>17 Side boundary setbacks – at least 900mm from the boundary of the allotment</p> <p>18 Total floor area does not exceed 40m²</p> <p>19 Wall height - does not exceed 3m measured from natural ground level (and not including a gable end)</p> <p>20 Building height - does not exceed 5m</p> <p>21 If situated on or abutting a boundary (not being a boundary with a primary street or secondary street) – a length not exceeding 10m unless:</p> <p style="padding-left: 20px;">(a) a longer wall or structure exists on the adjacent site and is situated on the same allotment boundary; and</p> <p style="padding-left: 20px;">(b) the proposed wall or structure will be built along the same length of boundary as the existing adjacent wall or structure to the same or lesser extent</p> <p>22 If the outbuilding abuts or is situated on the boundary of the allotment (not being a boundary with a primary street or secondary street):</p> <p style="padding-left: 20px;">(a) it will not result in all relevant walls or structures located along the boundary exceeding 45% of the length of the boundary; and</p> <p style="padding-left: 20px;">(b) will not be located within 3m of any other wall along the same boundary unless on an adjacent site on that boundary there is an existing wall of a building that would be adjacent to or abut the proposed wall or structure</p> <p>23 Total roofed area of all existing and proposed buildings on the allotment - does not exceed 60%</p> <p>24 If clad in sheet metal—is pre-colour treated or painted in a non-reflective colour.</p>
<p>Private bushfire shelters</p> <p>Except where any of the following apply:</p> <ul style="list-style-type: none"> • Coastal Areas Overlay • Hazards (Acid Sulfate Soils) Overlay • Hazards (Flooding) Overlay • Historic Area Overlay 	<p>1 The development will not be built, or encroach, on an area that is, or will be, required for a sewerage system or waste control system</p> <p>2 Primary street setback – at least as far back as the building to which it is ancillary</p> <p>3 Secondary street setback – at least 900mm from the boundary of the allotment</p> <p>4 At least 6m from the corner of an allotment which abuts the intersection of two or more roads (other than where a 4m x 4m allotment cut-off is already in place).</p>

<ul style="list-style-type: none"> • Historic Shipwrecks Overlay • Local Heritage Place Overlay • State Heritage Place Overlay • Native Vegetation Overlay • State Significant Native Vegetation Overlay • Ramsar Wetlands Overlay • River Murray Flood Plain Overlay • Sloping Land Overlay • Water Resources Overlay 	
<p>Protective tree netting structure</p> <p>Except where any of the following apply:</p> <ul style="list-style-type: none"> • Coastal Areas Overlay • Hazards (Acid Sulfate Soils) Overlay • Historic Area Overlay • Local Heritage Place Overlay • State Heritage Place Overlay • State Significant Native Vegetation Overlay • Ramsar Wetlands Overlay • River Murray Flood Plain Overlay • Sloping Land Overlay • Water Protection Area Overlay • Water Resources Overlay 	<ol style="list-style-type: none"> 1 The development will not be built, or encroach, on an area that is, or will be, required for a sewerage system or waste control system 2 No part of the protective tree netting structure will be more than 6m above natural ground level (depending on where it is situated) 3 Netting visible from the outside of the protective tree netting structure is of a low light-reflective nature, and, in the case of a structure that has side netting, the side netting is of a dark colour 4 In the case of a development on a site that is within a Hazards (Bushfire Protection) Overlay, the protective tree netting structure provides for access to the site in accordance with the following: <ol style="list-style-type: none"> (a) no part of the protective tree netting structure (including cables and points of attachment of cables (known as "auger" or "anchor" points) will be within 5m of any boundary of the site; or (b) does not prevent access or movement of vehicles of 4m height and 3.5m width (or less) on any access road or track (including fire tracks) on the site 5 No part of the netting canopy of the protective tree netting structure: <ol style="list-style-type: none"> (a) will cover native vegetation; or (b) will be within 5m of a road (including any road reserve) 6 The points of attachment of any cables will not be located: <ol style="list-style-type: none"> (a) outside the boundaries of the site; or

	<p>(b) within a watercourse (within the meaning of the <i>Natural Resources Management Act 2004</i>)</p> <p>7 In relation to a dwelling located on an allotment adjoining the site on which the protective tree netting structure is located, the protective tree netting structure complies with the following:</p> <p>(a) if the netting canopy nearest the dwelling on the adjoining allotment is 4m or less above ground level (depending on where it is situated), no part of the netting canopy is within 10m of the dwelling</p> <p>(b) in any other case, no part of the netting canopy is within 15m of the dwelling.</p>
<p>Shade sail</p> <p>Except where any of the following apply:</p> <ul style="list-style-type: none"> • Coastal Areas Overlay • Hazards (Acid Sulfate Soils) Overlay • Historic Area Overlay • Historic Shipwrecks Overlay • Local Heritage Place Overlay • State Heritage Place Overlay • Native Vegetation Overlay • State Significant Native Vegetation Overlay • Ramsar Wetlands Overlay • River Murray Flood Plain Overlay • Sloping Land Overlay • Water Resources Overlay 	<p>1 The development will not be built, or encroach, on an area that is, or will be, required for a sewerage system or waste control system</p> <p>2 Shade sail consists of permeable material</p> <p>3 The total area of the sail - does not exceed 40m²</p> <p>4 No part of the shade sail will be:</p> <p>(a) 3m above ground or floor level (depending on where it is situated) at any place within 900mm of a boundary of the allotment</p> <p>(b) 5m above ground or floor level (depending on where it is situated) within any other part of the allotment</p> <p>5 Primary street setback – at least as far back as the building line of the building to which it is ancillary</p> <p>6 If any part of the sail will be situated on a boundary of the allotment, the length of sail along a boundary does not exceed 8m</p> <p>7 In a case where any part of the sail or a supporting structure will be situated on a side boundary of the allotment – the length of the sail and any such supporting structure together with all relevant walls or structures located along the boundary will not exceed 45% of the length of the boundary.</p>
<p>Solar photovoltaic panels (roof mounted)</p>	<p>1 Panels are installed parallel to the roof of a building and with the underside surface of the panel not being more than 100mm above the surface of the roof</p>

<p>Except where any of the following apply:</p> <ul style="list-style-type: none"> • Historic Area Overlay • A Local Heritage Place identified in the Local Heritage Place Overlay • A State Heritage Place identified in the State Heritage Place Overlay 	<p>2 Panels and associated components do not overhang any part of the roof</p> <p>3 Does not apply to system with a generating capacity of more than 5MW that is to be connected to the State's power system.</p>
<p>Spa pool</p> <p>Swimming pool</p> <p>Except where any of the following apply:</p> <ul style="list-style-type: none"> • Coastal Areas Overlay • Hazards (Acid Sulfate Soils) Overlay • Hazards (Flooding) Overlay • Historic Area Overlay • Historic Shipwrecks Overlay • Local Heritage Place Overlay • State Heritage Place Overlay • Native Vegetation Overlay • State Significant Native Vegetation Overlay • Ramsar Wetlands Overlay • River Murray Flood Plain Overlay • Sloping Land Overlay • Water Resources Overlay 	<p>11 The development will not be built, or encroach, on an area that is, or will be, required for a sewerage system or waste control system</p> <p>12 It is ancillary to a dwelling erected on the site</p> <p>13 Allotment boundary setback – not less than 1m</p> <p>14 Primary street setback – at least as far back as the building line of the building to which it is ancillary</p> <p>15 Location of filtration system from a dwelling on an adjoining allotment:</p> <p>(a) not less than 5m where the filtration system is located inside a solid structure that will have material impact on the transmission of noise</p> <p>(b) not less than 12m in any other case.</p>
<p>Verandah</p> <p>Except where any of the following apply:</p>	<p>1 The development will not be built, or encroach, on an area that is, or will be, required for a sewerage system or waste control system</p> <p>2 It is ancillary to a dwelling erected on the site</p>

<ul style="list-style-type: none"> • Coastal Areas Overlay • Hazards (Acid Sulfate Soils) Overlay • Hazards (Flooding) Overlay • Historic Area Overlay • Historic Shipwrecks Overlay • Local Heritage Place Overlay • State Heritage Place Overlay • Native Vegetation Overlay • State Significant Native Vegetation Overlay • Ramsar Wetlands Overlay • River Murray Flood Plain Overlay • Water Resources Overlay 	<ol style="list-style-type: none"> 3 Primary street setback –as far back as the building line of the building to which it is ancillary 4 Total floor area - does not exceed 40m² 5 Post height - does not exceed 3m measured from natural ground level 6 Building height - does not exceed 5m 7 Verandah length - does not exceed 8m if any part of the structure abuts or is situated on a boundary of the allotment 8 Total roofed area of all existing and proposed buildings on the allotment - does not exceed 60%.
<p>Water tank (above ground)</p> <p>Except where any of the following apply:</p> <ul style="list-style-type: none"> • Coastal Areas Overlay • Hazards (Flooding) Overlay • Historic Area Overlay • Historic Shipwrecks Overlay • Local Heritage Place Overlay • State Heritage Place Overlay • Native Vegetation Overlay • State Significant Native Vegetation Overlay • Ramsar Wetlands Overlay • River Murray Flood Plain Overlay • Sloping Land Overlay 	<ol style="list-style-type: none"> 1 The development will not be built, or encroach, on an area that is, or will be, required for a sewerage system or waste control system 2 The development would not be contrary to the regulations prescribed for the purposes of section 86 of the <i>Electricity Act 1996</i> 3 The tank is part of a roof drainage system 4 Total floor area - not exceeding 15m² 5 The tank is located wholly above ground 6 Tank height – does not exceed 4m above natural ground level 7 Primary street setback – at least as far back as the building line of the building to which it is ancillary 8 In the case of a tank made of metal – the tank is pre-colour treated or painted in a non-reflective colour.

<ul style="list-style-type: none"> • Water Resources Overlay 	
<p>Water tank (underground)</p> <p>Except where any of the following apply:</p> <ul style="list-style-type: none"> • Coastal Areas Overlay • Hazards (Acid Sulfate Soils) Overlay • Historic Shipwrecks Overlay • Native Vegetation Overlay • State Significant Native Vegetation Overlay • Ramsar Wetlands Overlay • Sloping Land Overlay • Water Resources Overlay 	<ol style="list-style-type: none"> 1 The development will not be built, or encroach, on an area that is, or will be, required for a sewerage system or waste control system 9 The tank (including any associated pump) is located wholly below the level of the ground.

Table 2 – Deemed-to-Satisfy Development Classification

Class of Development The following Classes of Development are classified as Deemed-to-Satisfy Development subject to meeting the 'Deemed-to-Satisfy Development Classification Criteria'	Deemed-to-Satisfy Development Classification Criteria Provisions referred to are Deemed-to-Satisfy Criteria Where a development comprises more than one Class of Development the relevant criteria will be taken to be the sum of the criteria for each Class of Development.			
	Zone	General Development Policies	Subzone (applies only in the area affected by the Subzone)	Overlay (applies only in the area affected by the Overlay)
None Specified				

Table 3 – Applicable Policies for Performance Assessed Development

Class of Development	Applicable Policies			
	Zone	General Development Policies	Subzone (applies only in the area affected by the Subzone)	Overlay (applies only in the area affected by the Overlay)
Advertisement	[Land Use]: PO 1.1	Advertisements [Appearance]: PO 1.1, 1.3, 1.4, 1.5 Advertisements [Proliferation of Advertisements]: PO 2.1, 2.2 Advertisements [Advertising Content]: PO 3.1 Advertisements [Amenity Content]: PO 4.1 Advertisements [Safety]: PO 5.1, 5.2, 5.3, 5.4, 5.5 Clearance from Overhead Powerlines: PO 1.1	None	Airport Building Heights (Aircraft Landing Area): PO 1.1 Airport Building Heights (Regulated): PO 1.1, 1.2 Building Near Airfields: PO 1.1 Coastal Areas: All Defence Aviation Area: PO 1.1, 1.3 Hazards (Acid Sulfate Soils): PO 1.1 Hazards (Flooding) General: All Historic Area: All Historic Shipwrecks: PO 1.1 Key Outback and Rural Routes: PO 8.1, 10.1 Local Heritage Place: All Major Transport Routes: PO 8.1, DTS 10.1

Class of Development

Applicable Policies

The following policies are applicable to the assessment of the identified Class of Development. Policies referred to are Performance Outcome policies, and any associated Designated Performance Features. Relevant Desired Outcomes are not listed, but automatically apply in relation to a Performance Assessed Development.
 Where a development comprises more than one Class of Development the relevant policies will be taken to be the sum of the applicable policies for each Class of Development.

Zone	General Development Policies	Subzone (applies only in the area affected by the Subzone)	Overlay (applies only in the area affected by the Overlay)
-------------	-------------------------------------	--	--

				Marine Parks (Managed Use): All Marine Parks (Restricted Use): All Native Vegetation: PO 1.1, 1.2 Non-stop Corridor: All Ramsar Wetlands: All River Murray Flood Plain: All Sloping Land: All State Heritage Place: All State Significant Native Vegetation: All Urban Transport Routes: PO 8.1, 10.1 Water Resources: All
--	--	--	--	--

Aquaculture	[Land Use]: PO 1.1 [Environmental Protection]: All	Aquaculture: All	None	Airport Building Heights (Aircraft Landing Area): PO 1.1
--------------------	---	------------------	------	--

Class of Development

Applicable Policies

The following policies are applicable to the assessment of the identified Class of Development. Policies referred to are Performance Outcome policies, and any associated Designated Performance Features. Relevant Desired Outcomes are not listed, but automatically apply in relation to a Performance Assessed Development.
Where a development comprises more than one Class of Development the relevant policies will be taken to be the sum of the applicable policies for each Class of Development.

Zone	General Development Policies	Subzone (applies only in the area affected by the Subzone)	Overlay (applies only in the area affected by the Overlay)
-------------	-------------------------------------	--	--

	[Built Form and Character]: All		Airport Building Heights (Regulated): PO 1.1, 1.2 Building Near Airfields: PO 1.1 Coastal Areas: All Defence Aviation Area: PO 1.1, 1.3 Hazards (Acid Sulfate Soils): All Hazards (Bushfire – General Risk): PO 1.1 Hazards (Bushfire – High Risk): PO 1.1, 2.1, 6.1, 6.2 Hazards (Bushfire – Medium Risk): PO 1.1, 2.1, 5.1, 5.2
--	---------------------------------	--	--

Class of Development

Applicable Policies

The following policies are applicable to the assessment of the identified Class of Development. Policies referred to are Performance Outcome policies, and any associated Designated Performance Features. Relevant Desired Outcomes are not listed, but automatically apply in relation to a Performance Assessed Development.
Where a development comprises more than one Class of Development the relevant policies will be taken to be the sum of the applicable policies for each Class of Development.

Zone

General Development Policies

Subzone
(applies only in the area affected by the Subzone)

Overlay
(applies only in the area affected by the Overlay)

- Hazards (Bushfire – Outback): PO 2.1, 2.2
- Hazards (Bushfire – Regional): PO 1.1, 2.1, 5.1, 5.2
- Hazards (Flooding): All
- Historic Area: All
- Historic Shipwrecks: All
- Key Outback and Rural Routes: All
- Local Heritage Place: All
- Major Transport Routes: All
- Marine Parks (Managed Use): All
- Marine Parks (Restricted Use): All

Class of Development

Applicable Policies

The following policies are applicable to the assessment of the identified Class of Development. Policies referred to are Performance Outcome policies, and any associated Designated Performance Features. Relevant Desired Outcomes are not listed, but automatically apply in relation to a Performance Assessed Development.
Where a development comprises more than one Class of Development the relevant policies will be taken to be the sum of the applicable policies for each Class of Development.

Zone

General Development Policies

Subzone
(applies only in the area affected by the Subzone)

Overlay
(applies only in the area affected by the Overlay)

- Murray Darling Basin: All
- Native Vegetation: All
- Noise and Air Emissions: All
- Non-stop Corridor: All
- Prescribed Water Resources Area: All
- Prescribed Watercourses: All
- Prescribed Wells Area: All
- Ramsar Wetlands: All
- River Murray Flood Plain: All
- Sloping Land: All
- State Heritage Place: All

Class of Development	Applicable Policies			
	Zone	General Development Policies	Subzone (applies only in the area affected by the Subzone)	Overlay (applies only in the area affected by the Overlay)
				State Significant Native Vegetation: All Traffic Generating Development: All Urban Transport Routes: All Water Protection Area: All Water Resources: All
Agricultural Building	[Land Use] PO 1.1, 1.3 [Environmental Protection]: PO 3.1	Clearance from Overhead Powerlines: PO 1.1 Infrastructure and Renewable Energy Facilities [Wastewater Services]: PO 12.2		Airport Building Heights (Aircraft Landing Area): All Airport Building Heights (Regulated): All Building Near Airfields: PO 1.1

Class of Development

Applicable Policies

The following policies are applicable to the assessment of the identified Class of Development. Policies referred to are Performance Outcome policies, and any associated Designated Performance Features. Relevant Desired Outcomes are not listed, but automatically apply in relation to a Performance Assessed Development.
 Where a development comprises more than one Class of Development the relevant policies will be taken to be the sum of the applicable policies for each Class of Development.

Zone	General Development Policies	Subzone (applies only in the area affected by the Subzone)	Overlay (applies only in the area affected by the Overlay)
-------------	-------------------------------------	--	--

	[Built Form and Character]: PO 4.1, 4.2, 4.4 [Access and Car Parking]: PO 5.1, 5.2, 5.6	Interface between Land Uses [Activities Generating Noise or Vibration]: PO 4.1 Transport, Access and Parking [Movement Systems]: PO 1.4 Transport, Access and Parking [Vehicle Access]: PO 3.1	Coastal Areas: All Defence Aviation Area: PO 1.1, 1.3 Hazards (Acid Sulfate Soils): All Hazards (Bushfire - General Risk): PO 1.1, 2.1, 2.2 Hazards (Bushfire - High Risk): PO 2.1, 3.1, 3.2 Hazards (Bushfire - Medium Risk): PO 1.1, 2.1, 2.2 Hazards (Bushfire - Regional): PO 1.1, 2.1, 2.2 Hazards (Flooding): PO 2.1, 2.2, 2.3, 2.4, 3.1, 3.2, 4.1, 4.2
--	--	--	--

Class of Development

Applicable Policies

The following policies are applicable to the assessment of the identified Class of Development. Policies referred to are Performance Outcome policies, and any associated Designated Performance Features. Relevant Desired Outcomes are not listed, but automatically apply in relation to a Performance Assessed Development.
Where a development comprises more than one Class of Development the relevant policies will be taken to be the sum of the applicable policies for each Class of Development.

Zone

General Development Policies

Subzone
(applies only in the area affected by the Subzone)

Overlay
(applies only in the area affected by the Overlay)

- Historic Area: All
- Historic Shipwrecks: All
- Key Outback and Rural Routes: All
- Local Heritage Place: All
- Major Urban Transport Routes: All
- Marine Parks (Managed Use): All
- Marine Parks (Restricted Use): All
- Native Vegetation: All
- Non-stop Corridor: All
- Ramsar Wetlands: All
- River Murray Flood Plain: All

Class of Development	Applicable Policies			
	Zone	General Development Policies	Subzone (applies only in the area affected by the Subzone)	Overlay (applies only in the area affected by the Overlay)
				Sloping Land: All State Heritage Place: All State Significant Native Vegetation: All Urban Transport Routes: All Water Resources: All
Boat Berth	[Land Use] PO 1.1, 1.3 [Environmental Protection]: All	Marinas and On-Water Structures: All	None	Coastal Areas: All Hazards (Acid Sulfate Soils): All Historic Area: All Historic Shipwrecks: All

Class of Development

Applicable Policies

The following policies are applicable to the assessment of the identified Class of Development. Policies referred to are Performance Outcome policies, and any associated Designated Performance Features. Relevant Desired Outcomes are not listed, but automatically apply in relation to a Performance Assessed Development.
Where a development comprises more than one Class of Development the relevant policies will be taken to be the sum of the applicable policies for each Class of Development.

Zone

General Development Policies

Subzone
(applies only in the area affected by the Subzone)

Overlay
(applies only in the area affected by the Overlay)

- Local Heritage Place: All
- Marine Parks (Managed Use): All
- Marine Parks (Restricted Use): All
- Native Vegetation: All
- Ramsar Wetlands: All
- River Murray Flood Plain: All
- State Heritage Place: All
- State Significant Native Vegetation: All
- Water Resources: All

Class of Development

Applicable Policies

The following policies are applicable to the assessment of the identified Class of Development. Policies referred to are Performance Outcome policies, and any associated Designated Performance Features. Relevant Desired Outcomes are not listed, but automatically apply in relation to a Performance Assessed Development.
 Where a development comprises more than one Class of Development the relevant policies will be taken to be the sum of the applicable policies for each Class of Development.

Zone	General Development Policies	Subzone (applies only in the area affected by the Subzone)	Overlay (applies only in the area affected by the Overlay)
-------------	-------------------------------------	--	--

Demolition of a State or Local Heritage Place	None	None	None	Local Heritage Place: All State Heritage Place: All
Demolition within an Historic Areas Overlay area or State Heritage Area	None	None	None	Historic Area: All State Heritage Area: All
Farming	[Land Use]: PO 1.1 [Development on off-shore islands]: PO 2.2 [Environment Protection]: All	Interface between Land Uses [General Land Use Compatibility]: PO 1.2	None	Coastal Areas: All Historic Area: All Local Heritage Place: All Murray Darling Basin Native Vegetation

Class of Development	Applicable Policies The following policies are applicable to the assessment of the identified Class of Development. Policies referred to are Performance Outcome policies, and any associated Designated Performance Features. Relevant Desired Outcomes are not listed, but automatically apply in relation to a Performance Assessed Development. Where a development comprises more than one Class of Development the relevant policies will be taken to be the sum of the applicable policies for each Class of Development.			
	Zone	General Development Policies	Subzone (applies only in the area affected by the Subzone)	Overlay (applies only in the area affected by the Overlay)
				Noise and Air Emissions Non-stop Corridor Prescribed Water Resources Area Prescribed Watercourses Prescribed Wells Area Ramsar Wetlands Regulated Trees Resource Extraction Protection Area River Murray Flood Plain Sloping Land State Heritage Place

Class of Development	Applicable Policies			
	Zone	General Development Policies	Subzone (applies only in the area affected by the Subzone)	Overlay (applies only in the area affected by the Overlay)
				State Significant Native Vegetation Strategic Infrastructure Gas Pipelines Traffic Generating Development Urban Transport Routes Water Protection Area Water Resources
Jetty	[Land Use] PO 1.1, 1.3 [Environmental Protection]: All	Marinas and On-Water Structures: All	None	Coastal Areas: All Hazards (Acid Sulfate Soils): All Historic Area: All

Class of Development

Applicable Policies

The following policies are applicable to the assessment of the identified Class of Development. Policies referred to are Performance Outcome policies, and any associated Designated Performance Features. Relevant Desired Outcomes are not listed, but automatically apply in relation to a Performance Assessed Development.
Where a development comprises more than one Class of Development the relevant policies will be taken to be the sum of the applicable policies for each Class of Development.

Zone

General Development Policies

Subzone
(applies only in the area affected by the Subzone)

Overlay
(applies only in the area affected by the Overlay)

- Historic Shipwrecks: All
- Local Heritage Place: All
- Marine Parks (Managed Use): All
- Marine Parks (Restricted Use): All
- Native Vegetation: All
- Ramsar Wetlands: All
- River Murray Flood Plain: All
- State Heritage Place: All
- State Significant Native Vegetation: All
- Water Resources: All

Class of Development

Applicable Policies

The following policies are applicable to the assessment of the identified Class of Development. Policies referred to are Performance Outcome policies, and any associated Designated Performance Features. Relevant Desired Outcomes are not listed, but automatically apply in relation to a Performance Assessed Development.
Where a development comprises more than one Class of Development the relevant policies will be taken to be the sum of the applicable policies for each Class of Development.

Zone	General Development Policies	Subzone (applies only in the area affected by the Subzone)	Overlay (applies only in the area affected by the Overlay)
-------------	-------------------------------------	--	--

Solar farm	All	Clearance from Overhead Powerlines: PO 1.1 Infrastructure and Renewable Energy Facilities [General]: PO 1.1 Infrastructure and Renewable Energy Facilities [Visual Amenity]: PO 2.1, 2.2, 2.3 Infrastructure and Renewable Energy Facilities [Rehabilitation]: PO 3.1 Infrastructure and Renewable Energy Facilities [Hazard Management]: PO 4.1, 4.2, 4.3 Infrastructure and Renewable Energy Facilities [Electricity Infrastructure and Battery Storage Facilities]: PO 5.1	None	Airport Building Heights (Aircraft Landing Area): All Airport Building Heights (Regulated): All Building Near Airfields: All Coastal Areas: All Defence Aviation Area: All Hazards (Acid Sulfate Soils): All Hazards (Bushfire - High Risk): All Hazards (Bushfire - Medium Risk): All Hazards (Bushfire - General Risk): All
-------------------	-----	--	------	---

Class of Development

Applicable Policies

The following policies are applicable to the assessment of the identified Class of Development. Policies referred to are Performance Outcome policies, and any associated Designated Performance Features. Relevant Desired Outcomes are not listed, but automatically apply in relation to a Performance Assessed Development.
 Where a development comprises more than one Class of Development the relevant policies will be taken to be the sum of the applicable policies for each Class of Development.

Zone	General Development Policies	Subzone (applies only in the area affected by the Subzone)	Overlay (applies only in the area affected by the Overlay)
-------------	-------------------------------------	--	--

		Infrastructure and Renewable Energy Facilities [Renewable Energy Facilities]: PO 7.1 Infrastructure and Renewable Energy Facilities [Renewable Energy Facilities (Solar Power)]: PO 9.1, 9.2, 9.3, 9.4, Infrastructure and Renewable Energy Facilities [Temporary Facilities]: PO 13.1, 13.2 Design in Rural Areas [All Non-Residential Development – Wash-down and Waste Loading and Unloading]: PO 31.1 Interface Between Land Uses [General land use compatibility]: PO 1.2		Hazards (Bushfire - Urban Interface): All Hazards (Bushfire - Outback): All Hazards (Bushfire - Regional): All Hazards (Flooding): All Historic Area: All: All Historic Shipwrecks: All: All Key Outback and Rural Routes: All Local Heritage Place: All Major Transport Routes: All Marine Parks (Managed Use): All Marine Parks (Restricted Use): All
--	--	--	--	---

Class of Development

Applicable Policies

The following policies are applicable to the assessment of the identified Class of Development. Policies referred to are Performance Outcome policies, and any associated Designated Performance Features. Relevant Desired Outcomes are not listed, but automatically apply in relation to a Performance Assessed Development.
 Where a development comprises more than one Class of Development the relevant policies will be taken to be the sum of the applicable policies for each Class of Development.

Zone	General Development Policies	Subzone (applies only in the area affected by the Subzone)	Overlay (applies only in the area affected by the Overlay)
-------------	-------------------------------------	--	--

		Interface Between Land Uses [Activities Generating Noise or Vibration]: PO 4.1 Interface Between Land Uses [Solar Reflectivity / Glare]: PO 7.1 Transport, Access and Parking [Movement Systems]: PO 1.1, 1.4 Transport, Access and Parking [Sightlines]: PO 2.1 Transport, Access and Parking [Vehicle Access]: PO 3.1, 3.3, 3.4, 3.8, 3.9 Transport, Access and Parking [Vehicle Parking Areas]: PO 6.1, 6.2, 6.6		Native Vegetation: All Non-stop Corridor: All Ramsar Wetlands: All Resource Extraction Protection Area: All River Murray Flood Plain: All Sloping Land: All State Heritage Place: All State Significant Native Vegetation: All Traffic Generating Development: All
--	--	--	--	--

Class of Development	Applicable Policies			
	Zone	General Development Policies	Subzone (applies only in the area affected by the Subzone)	Overlay (applies only in the area affected by the Overlay)
				Urban Transport Routes: All Water Protection Area: All Water Resources: All
Wind farm	All	Clearance from Overhead Powerlines: PO 1.1 Infrastructure and Renewable Energy Facilities [General]: PO 1.1 Infrastructure and Renewable Energy Facilities [Visual Amenity]: PO 2.1, 2.2, 2.3 Infrastructure and Renewable Energy Facilities [Rehabilitation]: PO 3.1	None	Airport Building Heights (Aircraft Landing Area): All Airport Building Heights (Regulated): All Building Near Airfields: All Coastal Areas: All Defence Aviation Area: All Hazards (Acid Sulfate Soils): All

Class of Development

Applicable Policies

The following policies are applicable to the assessment of the identified Class of Development. Policies referred to are Performance Outcome policies, and any associated Designated Performance Features. Relevant Desired Outcomes are not listed, but automatically apply in relation to a Performance Assessed Development.
 Where a development comprises more than one Class of Development the relevant policies will be taken to be the sum of the applicable policies for each Class of Development.

Zone	General Development Policies	Subzone (applies only in the area affected by the Subzone)	Overlay (applies only in the area affected by the Overlay)
-------------	-------------------------------------	--	--

		<p>Infrastructure and Renewable Energy Facilities [Hazard Management]: PO 4.1, 4.2, 4.3</p> <p>Infrastructure and Renewable Energy Facilities [Electricity Infrastructure and Battery Storage Facilities]: PO 5.1</p> <p>Infrastructure and Renewable Energy Facilities [Renewable Energy Facilities]: PO 7.1</p> <p>Infrastructure and Renewable Energy Facilities [Renewable Energy Facilities (Wind Farm)]: PO 8.1, 8.2, 8.3, 8.4, 8.5</p>	<p>Hazards (Bushfire - High Risk): All</p> <p>Hazards (Bushfire - Medium Risk): All</p> <p>Hazards (Bushfire - General Risk): All</p> <p>Hazards (Bushfire - Urban Interface): All</p> <p>Hazards (Bushfire - Outback): All</p> <p>Hazards (Bushfire - Regional): All</p> <p>Hazards (Flooding): All</p> <p>Historic Area: All: All</p> <p>Historic Shipwrecks: All: All</p>
--	--	---	--

Class of Development

Applicable Policies

The following policies are applicable to the assessment of the identified Class of Development. Policies referred to are Performance Outcome policies, and any associated Designated Performance Features. Relevant Desired Outcomes are not listed, but automatically apply in relation to a Performance Assessed Development.
 Where a development comprises more than one Class of Development the relevant policies will be taken to be the sum of the applicable policies for each Class of Development.

Zone	General Development Policies	Subzone (applies only in the area affected by the Subzone)	Overlay (applies only in the area affected by the Overlay)
-------------	-------------------------------------	--	--

		<p>Infrastructure and Renewable Energy Facilities [Temporary Facilities]: PO 13.1, 13.2</p> <p>Design in Rural Areas [All Non-Residential Development – Wash-down and Waste Loading and Unloading]: PO 31.1</p> <p>Interface Between Land Uses [General land use compatibility]: PO 1.2</p> <p>Interface Between Land Uses [Overshadowing]: PO 3.4</p> <p>Interface Between Land Uses [Activities Generating Noise or Vibration]: PO 4.1</p>		<p>Key Outback and Rural Routes: All</p> <p>Local Heritage Place: All</p> <p>Major Transport Routes: All</p> <p>Marine Parks (Managed Use): All</p> <p>Marine Parks (Restricted Use): All</p> <p>Native Vegetation: All</p> <p>Non-stop Corridor: All</p> <p>Ramsar Wetlands: All</p> <p>Resource Extraction Protection Area: All</p> <p>River Murray Flood Plain: All</p> <p>Sloping Land: All</p>
--	--	--	--	---

Class of Development

Applicable Policies

The following policies are applicable to the assessment of the identified Class of Development. Policies referred to are Performance Outcome policies, and any associated Designated Performance Features. Relevant Desired Outcomes are not listed, but automatically apply in relation to a Performance Assessed Development.
 Where a development comprises more than one Class of Development the relevant policies will be taken to be the sum of the applicable policies for each Class of Development.

Zone	General Development Policies	Subzone (applies only in the area affected by the Subzone)	Overlay (applies only in the area affected by the Overlay)
-------------	-------------------------------------	--	--

		Interface Between Land Uses [Solar Reflectivity / Glare]: PO 7.1 Transport, Access and Parking [Movement Systems]: PO 1.1, 1.4 Transport, Access and Parking [Sightlines]: PO 2.1 Transport, Access and Parking [Vehicle Access]: PO 3.1, 3.3, 3.4, 3.8, 3.9 Transport, Access and Parking [Vehicle Parking Areas]: PO 6.1, 6.2, 6.6	State Heritage Place: All State Significant Native Vegetation: All Traffic Generating Development: All Urban Transport Routes: All Water Protection Area: All Water Resources: All
--	--	--	---

Class of Development	Applicable Policies			
	Zone	General Development Policies	Subzone (applies only in the area affected by the Subzone)	Overlay (applies only in the area affected by the Overlay)
Telecommunications Facility	All	Clearance from Overhead Powerlines: PO 1.1 Infrastructure and Renewable Energy Facilities [General]: PO 1.1 Infrastructure and Renewable Energy Facilities [Visual Amenity]: PO 2.1, 2.2, 2.3 Infrastructure and Renewable Energy Facilities [Rehabilitation]: PO 3.1 Infrastructure and Renewable Energy Facilities [Hazard Management]: PO 4.1, 4.2, 4.3 Infrastructure and Renewable Energy Facilities [Electricity Infrastructure and Battery Storage Facilities]: PO 5.1	None	Airport Building Heights (Aircraft Landing Area): All Airport Building Heights (Regulated): All Building Near Airfields: All Coastal Areas: All Defence Aviation Area: All Hazards (Acid Sulfate Soils): All Hazards (Bushfire - High Risk): All Hazards (Bushfire - Medium Risk): All Hazards (Bushfire - General Risk): All

The following policies are applicable to the assessment of the identified Class of Development. Policies referred to are Performance Outcome policies, and any associated Designated Performance Features. Relevant Desired Outcomes are not listed, but automatically apply in relation to a Performance Assessed Development.

Where a development comprises more than one Class of Development the relevant policies will be taken to be the sum of the applicable policies for each Class of Development.

Class of Development

Applicable Policies

The following policies are applicable to the assessment of the identified Class of Development. Policies referred to are Performance Outcome policies, and any associated Designated Performance Features. Relevant Desired Outcomes are not listed, but automatically apply in relation to a Performance Assessed Development.
 Where a development comprises more than one Class of Development the relevant policies will be taken to be the sum of the applicable policies for each Class of Development.

Zone	General Development Policies	Subzone (applies only in the area affected by the Subzone)	Overlay (applies only in the area affected by the Overlay)
-------------	-------------------------------------	--	--

		Infrastructure and Renewable Energy Facilities [Telecommunication Facilities]: PO 6.1, 6.2 Infrastructure and Renewable Energy Facilities [Temporary Facilities]: PO 13.1, 13.2 Design in Rural Areas [All Non-Residential Development – Wash-down and Waste Loading and Unloading]: PO 31.1 Interface Between Land Uses [General land use compatibility]: PO 1.2 Interface Between Land Uses [Overshadowing]: PO 3.4 Interface Between Land Uses [Solar Reflectivity / Glare]: PO 7.1		Hazards (Bushfire - Urban Interface): All Hazards (Bushfire - Outback): All Hazards (Bushfire - Regional): All Hazards (Flooding): All Historic Area: All: All Historic Shipwrecks: All: All Key Outback and Rural Routes: All Local Heritage Place: All Major Transport Routes: All Marine Parks (Managed Use): All Marine Parks (Restricted Use): All
--	--	---	--	---

Class of Development	Applicable Policies The following policies are applicable to the assessment of the identified Class of Development. Policies referred to are Performance Outcome policies, and any associated Designated Performance Features. Relevant Desired Outcomes are not listed, but automatically apply in relation to a Performance Assessed Development. Where a development comprises more than one Class of Development the relevant policies will be taken to be the sum of the applicable policies for each Class of Development.			
	Zone	General Development Policies	Subzone (applies only in the area affected by the Subzone)	Overlay (applies only in the area affected by the Overlay)
		Transport, Access and Parking [Movement Systems]: PO 1.1, 1.4 Transport, Access and Parking [Sightlines]: PO 2.1 Transport, Access and Parking [Vehicle Access]: PO 3.1, 3.3, 3.4, 3.8 Transport, Access and Parking [Vehicle Parking Areas]: PO 6.1, 6.2, 6.6		Native Vegetation: All Non-stop Corridor: All Ramsar Wetlands: All Resource Extraction Protection Area: All River Murray Flood Plain: All Sloping Land: All State Heritage Place: All State Significant Native Vegetation: All Traffic Generating Development: All

Class of Development

Applicable Policies

The following policies are applicable to the assessment of the identified Class of Development. Policies referred to are Performance Outcome policies, and any associated Designated Performance Features. Relevant Desired Outcomes are not listed, but automatically apply in relation to a Performance Assessed Development.
Where a development comprises more than one Class of Development the relevant policies will be taken to be the sum of the applicable policies for each Class of Development.

Zone	General Development Policies	Subzone (applies only in the area affected by the Subzone)	Overlay (applies only in the area affected by the Overlay)
-------------	-------------------------------------	--	--

			Urban Transport Routes: All Water Protection Area: All Water Resources: All
--	--	--	---

All other Code Assessed Development	All	All	None	Any Relevant Overlay: All
--	-----	-----	------	---------------------------

Table 4 –Restricted Development Classification

Class of Development	
The following Classes of Development are classified as Restricted	
None Specified	

Assessment Provisions (AP)

Desired Outcome (DO)

DO 1

Protection and enhancement of the natural marine and coastal environment and recognition of it as an important ecological, commercial, tourism and recreational resource and passage for safe watercraft navigation.

DO 2

Limited, low impact development on offshore islands that supports the protection and enhancement of natural ecological processes, scenic amenity and heritage, cultural, scientific and educational values.

Performance Outcomes and Deemed to Satisfy / Designated Performance Outcome Criteria

Land Use

PO 1.1

Small-scale, low impact development for the purpose of conservation, navigation, science, recreation, tourism or aquaculture.

DTS/DPF 1.1

Development comprises one or more of the following land uses:

- a) Advertisement;
- b) Agricultural building;
- c) Aquaculture;
- d) Boat berth;
- e) Camp grounds;
- f) Dwelling alterations or additions;
- g) Farming;
- h) Jetty;
- i) Navigation structures, boat berth, pier, pontoon or similar structure;
- j) Public amenities; or
- k) Renewable energy facility.

Development on off-shore islands

PO 2.1

Islands that are isolated from the mainland are not developed for residential development until the appropriate level of infrastructure, hazard protection and environmental management is in place.

DTS/DPF 2.1

None are applicable.

PO 2.2

Farming activities on offshore islands occur on already cleared land and outside of areas containing native vegetation, coastal dunes and wetlands.

DTS/DPF 2.2

None are applicable.

PO 2.3

Small scale tourist accommodation on offshore islands such as caravan and camping grounds, huts and cabins.

DTS/DPF 2.3

None are applicable.

PO 2.4

Renewable energy facilities and ancillary development where do not impact on the scenic quality of the coast and islands.

DTS/DPF 2.4

None are applicable.

PO 2.5

Small-scale ground mounted solar power facilities on islands that service existing approved development on the same land.

DTS/DPF 2.5

Solar power facilities:

- (a) do not generate more than 30KW;
- (b) generate power which is to be used wholly in association an approved land use;
- (c) are setback at least 10m from adjoining allotments in other ownership; and
- (d) are not located within 100m of a dwelling in other ownership.

Environmental Protection

PO 3.1

Development undertaken in a manner which minimises the potential for harm to the marine and coastal environment.

DTS/DPF 3.1

None are applicable.

PO 3.2

Development minimises the potential for harmful effects of turbidity, sedimentation, pollution, shading and effects on water flows of the marine environment both inside and outside of the zone.

DTS/DPF 3.2

None are applicable.

PO 3.3

Development avoids important nesting or breeding areas or areas that are important for the movement/migration patterns of fauna.

DTS/DPF 3.3

None are applicable.

PO 3.4

Development avoids delicate or environmentally-sensitive coastal areas and key habitat areas within and adjacent offshore islands, such as sand dunes, cliff tops, estuaries, wetlands, mangroves and samphire areas.

DTS/DPF 3.4

None are applicable.

PO 3.5

Offshore development sited to minimise potential impacts on and to protect the integrity of reserves under the National Parks and Wildlife Act 1972 and the Marine Parks Act 2007.

DTS/DPF 3.5

Offshore development is located not less than 1000m from the boundary of any reserve under the National Parks and Wildlife Act 1972, unless a lesser distance is agreed with the Minister responsible for that Act.

Built Form and Character

PO 4.1

Development on offshore islands sited and designed unobtrusively to minimise the visual impact on the natural environment by:

- (a) using low reflective materials and finishes that blend with, and colours that complement, the surrounding landscape;
- (b) being located below hilltops and ridgelines; and
- (c) being screened by existing vegetation.

DTS/DPF 4.1

None are applicable.

Land Division

PO 5.1

Land division on offshore islands that supports the management or improvement of the natural environment and does not result in additional allotments with frontage or access to the coast.

DTS/DPF 5.1

Land division on offshore islands that does not create any additional allotments, nor any additional allotments with frontage or direct access to the coast and is for the:

- (a) creation of a public road or a public reserve; or
- (b) minor adjustment of allotment boundaries to remove an anomaly in existing boundaries with respect to the location of existing buildings or structures.

Procedural Matters (PM)

Notification of Performance assessed development

All classes of performance assessed development are excluded from notification except

- (a) Telecommunications Facility
- (b) Renewable Energy Facility
- (c) Development identified as "all other code assessed development" in Coastal Waters Zone Table 3.

Deferred Urban Zone

Table 1 – Accepted Development Classification

Class of Development The following Classes of Development are classified as Accepted Development subject to meeting the 'Accepted Development Classification Criteria'	Accepted Development Classification Criteria
Building work on railway land	10 Building work is associated with a railway <ol style="list-style-type: none"> 1 It is situated (or to be situated) on railway land 2 It is required for the conduct or maintenance of railway activities.
Carport Except where any of the following apply: <ul style="list-style-type: none"> • Character Preservation District Overlay • Coastal Areas Overlay • Hazards (Flooding) Overlay • Historic Area Overlay • Historic Shipwrecks Overlay • Local Heritage Place Overlay • State Heritage Place Overlay • Native Vegetation Overlay • State Significant Native Vegetation Overlay • Ramsar Wetlands Overlay • River Murray Flood Plain Overlay • Sloping Land Overlay • Future Road Widening Overlay where an existing access is altered or a new access is created • Key Railway Crossings Overlay where an 	<ol style="list-style-type: none"> 1 The development will not be built, or encroach, on an area that is, or will be, required for a sewerage system or waste control system 2 It is ancillary to a dwelling erected on the site 3 Primary street setback – at least 5.5m from the primary street boundary and as far back as the building line of the building to which it is ancillary 4 Secondary street setback – at least 900mm from the boundary of the allotment (if the land has boundaries on two or more roads) 5 Total floor area - does not exceed 40m² 6 Post height - does not exceed 3m measured from natural ground level (and not including a gable end) 7 Building height - does not exceed 5m 8 If situated on or abutting a boundary (not being a boundary with a primary street or secondary street) – a length not exceeding 10m unless: <ol style="list-style-type: none"> (a) a longer wall or structure exists on the adjacent site and is situated on the same allotment boundary; and (b) the proposed wall or structure will be built along the same length of boundary as the existing adjacent wall or structure to the same or lesser extent 9 If the carport abuts or is situated on the boundary of the allotment (not being a boundary with a primary street or secondary street): <ol style="list-style-type: none"> (a) it will not result in all relevant walls or structures located along the boundary exceeding 45% of the length of the boundary; and (b) it will not be located within 3m of any other wall along the same boundary unless on an adjacent site on that

<p>existing access is altered or a new access is created</p> <ul style="list-style-type: none"> • Major Urban Transport Routes Overlay where an existing access is altered or a new access is created • Non-stop Corridor Overlay where an existing access is altered or a new access is created • Urban Transport Routes Overlay where an existing access is altered or a new access is created • Water Resources Overlay 	<p style="text-align: center;">boundary there is an existing wall of a building that would be adjacent to or abut the proposed wall or structure</p> <p>10 The total roofed area of all existing or proposed buildings on the allotment does not exceed 60% of the area of the allotment</p> <p>11 Door opening for vehicle access – does not exceed, in total, 7m in width or 50% of the width of the allotment frontage (whichever lesser)</p> <p>12 Internal dimensions – does not exceed 3.2m in width and 6m in length between all fences, walls and doors</p> <p>13 The carport:</p> <p style="margin-left: 20px;">(a) is located so that vehicle access:</p> <p style="margin-left: 40px;">i. is provided via a lawfully existing or authorised driveway or access point or an access point for which consent has been granted as part of an application for the division of land; or</p> <p style="margin-left: 40px;">ii. will use a driveway that:</p> <p style="margin-left: 60px;">A. is not located within 6 metres of an intersection of 2 or more roads or a pedestrian actuated crossing; and</p> <p style="margin-left: 60px;">B. will not interfere with an item of street furniture (including directional signs, lighting, seating and weather shelters), other infrastructure, or a tree; or</p> <p style="margin-left: 40px;">iii. if adjacent a kerbed road, will be via a kerb that is designed to allow a vehicle to roll over it; and</p> <p style="margin-left: 20px;">(b) is located so that the gradient from the place of access on the boundary of the allotment to the finished floor level at the front of the carport when the work is completed is not steeper than 1:4 on average; and</p> <p style="margin-left: 20px;">(c) The centre of the driveway at the public road boundary is no more than 25 degree deviation from the centre of the front of the covered car parking space for which it provides vehicle access</p>
<p>Internal building work</p> <p>Except where any of the following apply:</p> <ul style="list-style-type: none"> • A Historic Shipwreck identified in the Historic Shipwrecks Overlay • A Local Heritage Place identified in the Local Heritage Place Overlay • A State Heritage Place identified in the State Heritage Place Overlay 	<p>5 There will be no increase in the total floor area of the building</p> <p>6 There will be no alteration to the external appearance of the building.</p>

Outbuilding (in the form of a garage)

Except where any of the following apply:

- Character Preservation District Overlay
- Coastal Areas Overlay
- Hazards (Flooding) Overlay
- Historic Area Overlay
- Historic Shipwrecks Overlay
- Local Heritage Place Overlay
- State Heritage Place Overlay
- Native Vegetation Overlay
- State Significant Native Vegetation Overlay
- Ramsar Wetlands Overlay
- River Murray Flood Plain Overlay
- Sloping Land Overlay
- Future Road Widening Overlay where an existing access is altered or a new access is created
- Key Railway Crossings Overlay where an existing access is altered or a new access is created
- Major Urban Transport Routes Overlay where an existing access is altered or a new access is created
- Non-stop Corridor Overlay where an existing access is altered or a new access is created
- Urban Transport Routes Overlay where an existing access is altered or a new access is created
- Water Resources Overlay

- 29 The development will not be built, or encroach, on an area that is, or will be, required for a sewerage system or waste control system
- 30 It is detached from and ancillary to a dwelling erected on the site.
- 31 Primary street setback – at least 5.5m from the primary street boundary and as far back as the building line of the building to which it is ancillary
- 32 Secondary street setback – at least 900mm from the boundary of the allotment (if the land has boundaries on two or more roads)
- 33 Total floor area - does not exceed 40m²
- 34 Wall height - does not exceed 3m measured from natural ground level (and not including a gable end)
- 35 Building height - does not exceed 5m
- 36 If situated on or abutting a boundary (not being a boundary with a primary street or secondary street) – a length not exceeding 10m unless:
 - (a) a longer wall or structure exists on the adjacent site and is situated on the same allotment boundary; and
 - (b) the proposed wall or structure will be built along the same length of boundary as the existing adjacent wall or structure to the same or lesser extent
- 37 If the outbuilding abuts or is situated on the boundary of the allotment (not being a boundary with a primary street or secondary street):
 - (a) it will not result in all relevant walls or structures located along the boundary exceeding 45% of the length of the boundary; and
 - (b) it will not be located within 3m of any other wall along the same boundary unless on an adjacent site on that boundary there is an existing wall of a building that would be adjacent to or abut the proposed wall or structure
- 38 Total roofed area of all existing and proposed buildings on the allotment - does not exceed 60%
- 39 Internal dimensions – exceed 3.2m in width and 6m in length between all walls and doors
- 40 Door opening for vehicle access – does not exceed, in total, 7m in width or 50% of the width of the allotment frontage (whichever lesser)
- 41 The garage:
 - (a) is located so that vehicle access:
 - i. is provided via a lawfully existing or authorised driveway or access point or an access point for which consent has been granted as part of an application for the division of land; or

	<ul style="list-style-type: none"> ii. will use a driveway that: <ul style="list-style-type: none"> A. is not located within 6 metres of an intersection of 2 or more roads or a pedestrian actuated crossing; and B. will not interfere with an item of street furniture (including directional signs, lighting, seating and weather shelters), other infrastructure, or a tree; or iii. if adjacent a kerbed road, will be via a kerb that is designed to allow a vehicle to roll over it; and <p>(b) is located so that the gradient from the place of access on the boundary of the allotment to the finished floor level at the front of the carport when the work is completed is not steeper than 1:4 on average; and</p> <p>(c) The centre of the driveway at the public road boundary is no more than 25 degree deviation from the centre of the front of the covered car parking space for which it provides vehicle access</p> <p>42 If clad in sheet metal—is pre-colour treated or painted in a non-reflective colour.</p>
<p>Outbuilding (not being a garage)</p> <p>Except where any of the following apply:</p> <ul style="list-style-type: none"> • Character Preservation District Overlay • Coastal Areas Overlay • Hazards (Flooding) Overlay • Historic Area Overlay • Historic Shipwrecks Overlay • Local Heritage Place Overlay • State Heritage Place Overlay • Native Vegetation Overlay • State Significant Native Vegetation Overlay • Ramsar Wetlands Overlay • River Murray Flood Plain Overlay • Sloping Land Overlay • Water Resources Overlay 	<p>25 The development will not be built, or encroach, on an area that is, or will be, required for a sewerage system or waste control system</p> <p>26 It is detached from and ancillary to a dwelling erected on the site</p> <p>27 Primary street setback – at least as far back as the building line of the building to which it is ancillary</p> <p>28 Secondary street setback – at least 900mm from the boundary of the allotment (if the land has boundaries on two or more roads)</p> <p>29 Side boundary setbacks – at least 900mm from the boundary of the allotment</p> <p>30 Total floor area does not exceed 40m²</p> <p>31 Wall height - does not exceed 3m measured from natural ground level (and not including a gable end)</p> <p>32 Building height - does not exceed 5m</p> <p>33 If situated on or abutting a boundary (not being a boundary with a primary street or secondary street) – a length not exceeding 10m unless:</p> <ul style="list-style-type: none"> (a) a longer wall or structure exists on the adjacent site and is situated on the same allotment boundary; and (b) the proposed wall or structure will be built along the same length of boundary as the existing adjacent wall or structure to the same or lesser extent

	<p>34 If the outbuilding abuts or is situated on the boundary of the allotment (not being a boundary with a primary street or secondary street):</p> <p>(a) it will not result in all relevant walls or structures located along the boundary exceeding 45% of the length of the boundary; and</p> <p>(b) will not be located within 3m of any other wall along the same boundary unless on an adjacent site on that boundary there is an existing wall of a building that would be adjacent to or abut the proposed wall or structure</p> <p>35 Total roofed area of all existing and proposed buildings on the allotment - does not exceed 60%</p> <p>36 If clad in sheet metal—is pre-colour treated or painted in a non-reflective colour.</p>
<p>Private bushfire shelters</p> <p>Except where any of the following apply:</p> <ul style="list-style-type: none"> • Character Preservation District Overlay • Coastal Areas Overlay • Hazards (Flooding) Overlay • Historic Area Overlay • Historic Shipwrecks Overlay • Local Heritage Place Overlay • State Heritage Place Overlay • Native Vegetation Overlay • State Significant Native Vegetation Overlay • Ramsar Wetlands Overlay • River Murray Flood Plain Overlay • Sloping Land Overlay • Water Resources Overlay 	<p>9 The development will not be built, or encroach, on an area that is, or will be, required for a sewerage system or waste control system</p> <p>10 Primary street setback – at least as far back as the building to which it is ancillary</p> <p>11 Secondary street setback – at least 900mm from the boundary of the allotment</p> <p>12 At least 6m from the corner of an allotment which abuts the intersection of two or more roads (other than where a 4m x 4m allotment cut-off is already in place).</p>
<p>Shade sail</p> <p>Except where any of the following apply:</p> <ul style="list-style-type: none"> • Character Preservation District Overlay • Coastal Areas Overlay • Historic Area Overlay • Historic Shipwrecks Overlay 	<p>15 The development will not be built, or encroach, on an area that is, or will be, required for a sewerage system or waste control system</p> <p>16 Shade sail consists of permeable material</p> <p>17 The total area of the sail - does not exceed 40m²</p> <p>18 No part of the shade sail will be:</p> <p>(a) 3m above ground or floor level (depending on where it is situated) at any place within 900mm of a boundary of the allotment</p>

<ul style="list-style-type: none"> • Local Heritage Place Overlay • State Heritage Place Overlay • Native Vegetation Overlay • State Significant Native Vegetation Overlay • Ramsar Wetlands Overlay • River Murray Flood Plain Overlay • Sloping Land Overlay • Water Resources Overlay 	<p>(b) 5m above ground or floor level (depending on where it is situated) within any other part of the allotment</p> <p>19 Primary street setback – at least as far back as the building line of the building to which it is ancillary</p> <p>20 If any part of the sail will be situated on a boundary of the allotment, the length of sail along a boundary does not exceed 8m</p> <p>21 In a case where any part of the sail or a supporting structure will be situated on a side boundary of the allotment — the length of the sail and any such supporting structure together with all relevant walls or structures located along the boundary will not exceed 45% of the length of the boundary.</p>
<p>Solar photovoltaic panels (roof mounted)</p> <p>Except where any of the following apply:</p> <ul style="list-style-type: none"> • Historic Area Overlay • A Local Heritage Place identified in the Local Heritage Place Overlay • A State Heritage Place identified in the State Heritage Place Overlay 	<p>10 Panels are installed parallel to the roof of a building and with the underside surface of the panel not being more than 100mm above the surface of the roof</p> <p>11 Panels and associated components do not overhang any part of the roof</p> <p>12 Does not apply to system with a generating capacity of more than 5MW that is to be connected to the State's power system.</p>
<p>Spa pool</p> <p>Swimming pool</p> <p>Except where any of the following apply:</p> <ul style="list-style-type: none"> • Character Preservation District Overlay • Coastal Areas Overlay • Hazards (Flooding) Overlay • Historic Area Overlay • Local Heritage Place Overlay • State Heritage Place Overlay • Historic Shipwrecks Overlay • Native Vegetation Overlay • State Significant Native Vegetation Overlay • Ramsar Wetlands Overlay • River Murray Flood Plain Overlay 	<p>16 The development will not be built, or encroach, on an area that is, or will be, required for a sewerage system or waste control system</p> <p>17 It is ancillary to a dwelling erected on the site</p> <p>18 Allotment boundary setback – not less than 1m</p> <p>19 Primary street setback – at least as far back as the building line of the building to which it is ancillary</p> <p>20 Location of filtration system from a dwelling on an adjoining allotment:</p> <p>(a) not less than 5m where the filtration system is located inside a solid structure that will have material impact on the transmission of noise</p> <p>(b) not less than 12m in any other case.</p>

<ul style="list-style-type: none"> • Significant Landscape Protection Overlay • Sloping Land Overlay • Water Resources Overlay. 	
<p>Verandah</p> <p>Except where any of the following apply:</p> <ul style="list-style-type: none"> • Character Preservation District Overlay • Coastal Areas Overlay • Hazards (Flooding) Overlay • Historic Area Overlay • Historic Shipwrecks Overlay • Local Heritage Place Overlay • State Heritage Place Overlay • Native Vegetation Overlay • State Significant Native Vegetation Overlay • Ramsar Wetlands Overlay • River Murray Flood Plain Overlay • Water Resources Overlay 	<p>9 The development will not be built, or encroach, on an area that is, or will be, required for a sewerage system or waste control system</p> <p>10 It is ancillary to a dwelling erected on the site</p> <p>11 Primary street setback – as far back as the building line of the building to which it is ancillary</p> <p>12 Total floor area - does not exceed 40m²</p> <p>13 Post height - does not exceed 3m measured from natural ground level</p> <p>14 Building height - does not exceed 5m</p> <p>15 Length - does not exceed 10m if any part of the structure abuts or is situated on a boundary of the allotment</p> <p>16 Total roofed area of all existing and proposed buildings on the allotment - does not exceed 60%.</p>
<p>Water tank (above ground)</p> <p>Except where any of the following apply:</p> <ul style="list-style-type: none"> • Character Preservation District Overlay • Coastal Areas Overlay • Hazards (Flooding) Overlay • Historic Area Overlay • Historic Shipwrecks Overlay • Local Heritage Place Overlay • State Heritage Place Overlay • Native Vegetation Overlay 	<p>22 The development will not be built, or encroach, on an area that is, or will be, required for a sewerage system or waste control system</p> <p>23 The tank is part of a roof drainage system</p> <p>24 Total floor area - not exceeding 15m²</p> <p>25 The tank is located wholly above ground</p> <p>26 Tank height – does not exceed 4m above natural ground level</p> <p>27 Primary street setback – at least as far back as the building line of the building to which it is ancillary</p> <p>28 In the case of a tank made of metal – the tank is pre-colour treated or painted in a non-reflective colour.</p>

<ul style="list-style-type: none"> • State Significant Native Vegetation Overlay • Ramsar Wetlands Overlay • River Murray Flood Plain Overlay • Sloping Land Overlay • Water Resources Overlay 	
<p>Water tank (underground) Except where any of the following apply:</p> <ul style="list-style-type: none"> • Character Preservation District Overlay • Coastal Areas Overlay • Historic Shipwrecks Overlay • Native Vegetation Overlay • State Significant Native Vegetation Overlay • Ramsar Wetlands Overlay • Sloping Land Overlay • Water Resources Overlay 	<p>7 The development will not be built, or encroach, on an area that is, or will be, required for a sewerage system or waste control system</p> <p>8 The tank (including any associated pump) is located wholly below the level of the ground.</p>
<p>Protective tree netting structure Except where any of the following apply:</p> <ul style="list-style-type: none"> • Coastal Areas Overlay • Historic Area Overlay • Local Heritage Place Overlay • State Heritage Place Overlay • State Significant Native Vegetation Overlay • Ramsar Wetlands Overlay • River Murray Flood Plain Overlay • Sloping Land Overlay • Water Protection Area Overlay 	<p>8 The development will not be built, or encroach, on an area that is, or will be, required for a sewerage system or waste control system</p> <p>9 No part of the protective tree netting structure will be more than 6m above natural ground level (depending on where it is situated)</p> <p>10 Netting visible from the outside of the protective tree netting structure is of a low light-reflective nature, and, in the case of a structure that has side netting, the side netting is of a dark colour</p> <p>11 In the case of a development on a site that is within a Hazards (Bushfire - Outback) Overlay, Hazards (Bushfire – Regional) Overlay, Hazards (Bushfire - General Risk) Overlay, Hazards (Bushfire Medium - Risk) Overlay or Hazards (Bushfire - High Risk) Overlay, the protective tree netting structure provides for access to the site in accordance with the following:</p> <p>(c) no part of the protective tree netting structure (including cables and points of attachment of cables (known as "auger" or "anchor" points) will be within 5m of any boundary of the site; or</p>

<ul style="list-style-type: none"> Water Resources Overlay 	<p>(d) does not prevent access or movement of vehicles of 4m height and 3.5m width (or less) on any access road or track (including fire tracks) on the site</p> <p>12 No part of the netting canopy of the protective tree netting structure:</p> <p>(c) will cover native vegetation; or</p> <p>(d) will be within 5m of a road (including any road reserve)</p> <p>13 The points of attachment of any cables will not be located:</p> <p>(c) outside the boundaries of the site; or</p> <p>(d) within a watercourse (within the meaning of the Natural Resources Management Act 2004)</p> <p>14 In relation to a dwelling located on an allotment adjoining the site on which the protective tree netting structure is located, the protective tree netting structure complies with the following:</p> <p>(c) if the netting canopy nearest the dwelling on the adjoining allotment is 4m or less above ground level (depending on where it is situated), no part of the netting canopy is within 10m of the dwelling</p> <p>(d) in any other case, no part of the netting canopy is within 15m of the dwelling.</p>
---	---

Table 2 – Deemed-to-Satisfy Development Classification

<p>The following Classes of Development are classified as Deemed-to-Satisfy Development subject to meeting the 'Deemed-to-Satisfy Development Classification Criteria'</p>	<p>Deemed-to-Satisfy Development Classification Criteria</p>			
	<p>Provisions referred to are Deemed-to-Satisfy Criteria Where a development comprises more than one Class of Development the relevant criteria will be taken to be the sum of the criteria for each Class of Development.</p>			
			<p>(applies only in the area affected by the Subzone)</p>	<p>(applies only in the area affected by the Overlay)</p>
<p>Agricultural building Except where any of the following apply:</p>	<p>None</p>	<p>Clearance from Overhead Powerlines: DTS 1.1 Infrastructure and Renewable Energy Facilities [Wastewater Services]: DTS 12.2</p>	<p>None</p>	<p>Airport Building Heights (Aircraft Landing Area): DTS 1.1, 1.2 Airport Building Heights (Regulated): DTS 1.1, 1.2</p>

Deemed-to-Satisfy Development Classification Criteria				
The following Classes of Development are classified as Deemed-to-Satisfy Development subject to meeting the 'Deemed-to-Satisfy Development Classification Criteria'	Provisions referred to are Deemed-to-Satisfy Criteria Where a development comprises more than one Class of Development the relevant criteria will be taken to be the sum of the criteria for each Class of Development.			
			(applies only in the area affected by the Subzone)	(applies only in the area affected by the Overlay)
<ul style="list-style-type: none"> • Character Preservation District Overlay • Coastal Areas Overlay • Hazards (Flooding) Overlay • Historic Area Overlay • Historic Shipwrecks Overlay • Local Heritage Place Overlay • Major Urban Transport Routes Overlay • Ramsar Wetlands Overlay • River Murray Flood Plain Overlay • Sloping Land Overlay • State Heritage Place Overlay • Water Resources Overlay 		<p>Interface between Land Uses [Activities Generating Noise or Vibration]: DTS 4.1</p> <p>Transport, Access and Parking [Movement Systems]: DTS 1.4</p> <p>Transport, Access and Parking [Vehicle Access]: DTS 3.1</p>		<p>Building Near Airfields: DTS 1.1, 1.2</p> <p>Defence Aviation Area: DTS 1.1, 1.3</p> <p>Future Road Widening: DTS 1.1</p> <p>Hazards (Acid Sulfate Soils): DTS 1.1</p> <p>Key Outback and Rural Routes: All</p> <p>Major Urban Transport Routes: All</p> <p>Mt Lofty Ranges Catchment (Area 2): DTS 3.4</p> <p>Native Vegetation: DTS 1.1, 1.2</p> <p>State Significant Native Vegetation: DTS 1.1</p> <p>Urban Transport Routes: All</p>
<p>Land division</p> <ul style="list-style-type: none"> • Character Preservation District Overlay 	[Land Division]: DTS 3.1	None	None	Native Vegetation: DTS 2.1

<p>The following Classes of Development are classified as Deemed-to-Satisfy Development subject to meeting the 'Deemed-to-Satisfy Development Classification Criteria'</p>	<p>Deemed-to-Satisfy Development Classification Criteria</p> <p>Provisions referred to are Deemed-to-Satisfy Criteria Where a development comprises more than one Class of Development the relevant criteria will be taken to be the sum of the criteria for each Class of Development.</p>			
			<p>(applies only in the area affected by the Subzone)</p>	<p>(applies only in the area affected by the Overlay)</p>
<ul style="list-style-type: none"> • Coastal Areas Overlay • Environment and Food Production Area Overlay • Local Heritage Place Overlay • Ramsar Wetlands Overlay • River Murray Flood Plain Overlay • State Heritage Place Overlay • State Significant Native Vegetation Overlay 				

Table 3 – Applicable Policies for Performance Assessed Development

	<p>The following policies are applicable to the assessment of the identified Class of Development. Policies referred to are Performance Outcome policies, and any associated Designated Performance Features. Relevant Desired Outcomes are not listed, but automatically apply in relation to a Performance Assessed Development. Where a development comprises more than one Class of Development the relevant policies will be taken to be the sum of the applicable policies for each Class of Development.</p>			
			(applies only in the area affected by the Subzone)	(applies only in the area affected by the Overlay)
Demolition of a State or Local Heritage Place	None	None	N/A	Local Heritage Place: All State Heritage Place: All
Demolition within an Historic Area: All or State Heritage Area: All	None	None	N/A	Historic Area: All State Heritage Area: All
Tree damaging activity	None	None	N/A	Regulated Tree: All
All other Code Assessed Development	All	All	N/A	All

Table 4 –Restricted Development Classification

<p>The following Classes of Development are classified as Restricted</p>	
<p>Dwelling that results in more than one dwelling on an allotment</p>	<p>N/A</p>
<p>Land division</p>	<p>Land division that does not create additional allotments other than for the purpose of providing public infrastructure</p>

Assessment Provisions

Desired Outcome (DO)

DO 1

To safeguard land for future urban growth.

Performance Outcomes and Deemed to Satisfy / Designated Performance Outcome Criteria

Land Use and Intensity

PO 1.1

Development that is incompatible, prejudicial or detrimental to the orderly and efficient servicing and conversion of the land for future urban growth does not occur.

DTS/DPF 1.1

None are applicable.

Built Form and Character

PO 2.1

Development maintains an open character.

DTS/DPF 2.1

None are applicable

PO 2.2

Buildings limited to those that:

- (a) are ancillary to and necessary to support existing land use activities on the same allotment;
- (b) are for the purposes of public infrastructure.

DTS/DPF 2.2

None are applicable

Land Division

PO 3.1

Land division limited to that which:

- (a) corrects anomalies in the placement of allotment boundaries with respect to the location of existing buildings or structures; or
- (b) enables the provision of public infrastructure.

DTS/DPF 3.1

Land division is for:

- (a) the alteration of allotment boundaries, where no additional allotments are created; or
- (b) the purpose of providing public infrastructure.

Concept Plans

PO 4.1

Development is compatible with the outcomes sought by any relevant Concept Plan contained within the *Concept Plans Technical and Numeric Variation Overlay*.

DTS 4.1

None are applicable.

Procedural Matters

Notification

All classes of performance assessed development are excluded from notification except where they involve any of the following:

- (a) the site of the development is adjacent land to land in a different zone

(b) development identified as "all other code assessed development" in Deferred Urban Zone Table 3

Placement of Notices – Exemptions for Performance Assessed Development

None specified.

Placement of Notices – Exemptions for Restricted Development

None specified.

Employment Zone

Table 1 – Accepted Development Classification

Class of Development The following Classes of Development are classified as Accepted Development subject to meeting the 'Accepted Development Classification Criteria'	Accepted Development Classification Criteria
Building work on railway land	<ol style="list-style-type: none"> 1 Building work is associated with a railway 2 It is situated (or to be situated) on railway land 3 It is required for the conduct or maintenance of railway activities.
Internal building work Except where any of the following apply: <ul style="list-style-type: none"> • A Local Heritage Place identified in the Local Heritage Place Overlay • State Heritage Area Overlay • A State Heritage Place identified in the State Heritage Place Overlay 	<ol style="list-style-type: none"> 1 There will be no increase in the total floor area of the building 2 There will be no alteration to the external appearance of the building.
Shade sail Except where any of the following apply: <ul style="list-style-type: none"> • Character Preservation District Overlay • Coastal Areas Overlay • Character Area Overlay • Historic Area Overlay • Local Heritage Place Overlay • State Heritage Area Overlay • State Heritage Place Overlay • Native Vegetation Overlay • State Significant Native Vegetation Overlay • River Murray Flood Plain Overlay • Sloping Land Overlay • Water Resources Overlay 	<ol style="list-style-type: none"> 1 The development will not be built, or encroach, on an area that is, or will be, required for a sewerage system or waste control system 2 Shade sail consists of permeable material 3 The total area of the sail - does not exceed 40m² 4 No part of the shade sail will be: <ol style="list-style-type: none"> (a) 3m above ground or floor level (depending on where it is situated) at any place within 900mm of a boundary of the allotment (b) 5m above ground or floor level (depending on where it is situated) within any other part of the allotment 5 Primary street setback – at least as far back as the building line of the building to which it is ancillary 6 If any part of the sail will be situated on a boundary of the allotment, the length of sail along a boundary does not exceed 8m 7 In a case where any part of the sail or a supporting structure will be situated on a side boundary of the allotment – the length of the sail and any such supporting structure together with all relevant walls or structures located along the boundary will not exceed 45% of the length of the boundary.

<p>Solar photovoltaic panels (roof mounted) Except where any of the following apply:</p> <ul style="list-style-type: none"> • Historic Area Overlay • A Local Heritage Place identified in the Local Heritage Place Overlay • State Heritage Area Overlay • A State Heritage Place identified in the State Heritage Place Overlay 	<ol style="list-style-type: none"> 1 Panels are installed parallel to the roof of a building and with the underside surface of the panel not being more than 100mm above the surface of the roof 2 Panels and associated components do not overhang any part of the roof 3 Does not apply to system with a generating capacity of more than 5MW that is to be connected to the State's power system.
<p>Water tank (above ground) Except where any of the following apply:</p> <ul style="list-style-type: none"> • Character Preservation District Overlay • Coastal Areas Overlay • Hazards (Flooding) Overlay • Character Area Overlay • Historic Area Overlay • Local Heritage Place Overlay • State Heritage Area Overlay • State Heritage Place Overlay • Native Vegetation Overlay • State Significant Native Vegetation Overlay • River Murray Flood Plain Overlay • Sloping Land Overlay • Water Resources Overlay 	<ol style="list-style-type: none"> 1 The development will not be built, or encroach, on an area that is, or will be, required for a sewerage system or waste control system 2 The tank is part of a roof drainage system 3 Total floor area - not exceeding 15m² 4 The tank is located wholly above ground 5 Tank height – does not exceed 4m above natural ground level 6 Primary street setback – at least as far back as the building line of the building to which it is ancillary 7 In the case of a tank made of metal – the tank is pre-colour treated or painted in a non-reflective colour.
<p>Water tank (underground) Except where any of the following apply:</p> <ul style="list-style-type: none"> • Character Preservation District Overlay • Coastal Areas Overlay • Native Vegetation Overlay • State Significant Native Vegetation Overlay • Sloping Land Overlay • Water Resources Overlay 	<ol style="list-style-type: none"> 1 The development will not be built, or encroach, on an area that is, or will be, required for a sewerage system or waste control system 2 The tank (including any associated pump) is located wholly below the level of the ground.

Table 2 – Deemed-to-Satisfy Development Classification

Class of Development	Deemed-to-Satisfy Development Classification Criteria			
	Zone	General Development Policies	Subzone	Overlay
<p>The following Classes of Development are classified as Deemed-to-Satisfy Development subject to meeting the 'Deemed-to-Satisfy Development Classification Criteria'</p>	<p>Provisions referred to are Deemed-to-Satisfy Criteria</p> <p>Where a development comprises more than one Class of Development the relevant criteria will be taken to be the sum of the criteria for each Class of Development.</p>			
<p>Advertisement</p> <p>Except where any of the following apply:</p> <ul style="list-style-type: none"> Advertising Near Signalised Intersections Overlay Character Area Overlay Character Preservation District Overlay Coastal Areas Overlay Hazards (Flooding) Overlay Historic Area Overlay Local Heritage Place Overlay Marine Parks (Managed Use) Overlay Murray Darling Basin Overlay Non-stop Corridor Overlay River Murray Flood Plain Overlay River Murray Tributaries Area Overlay Sloping Land Overlay State Heritage Area Overlay State Heritage Place Overlay Water Protection Area Overlay Water Resources Overlay 	<p>[Advertisements]: DTS 7.1</p>	<p>Advertisements [Appearance]: DTS 1.1, 1.3, 1.4</p> <p>Advertisements [Proliferation of Advertisements]: DTS 2.1, 2.2</p> <p>Advertisements [Advertising Content]: DTS 3.1</p> <p>Advertisements [Amenity Content]: DTS 4.1</p> <p>Advertising [Safety]: DTS 5.1, 5.2, 5.3, 5.4, 5.5</p> <p>Clearance from Overhead Powerlines: DTS 1.1</p>	<p>None</p>	<p>Airport Building Heights (Aircraft Landing Area): DTS 1.1</p> <p>Airport Building Heights (Regulated): DTS 1.1, 1.2</p> <p>Building Near Airfields: DTS 1.1, 1.2</p> <p>Defence Aviation Area: DTS 1.1, 1.3</p> <p>Future Road Widening: DTS 1.1</p> <p>Key Outback and Rural Routes: DTS 8.1, 10.1</p> <p>Key Railway Crossings: DTS 1.1</p> <p>Major Transport Routes: DTS 8.1, 10.1</p> <p>Native Vegetation: DTS 1.1, 1.2</p> <p>State Significant Native Vegetation: DTS 1.1</p> <p>Urban Transport Routes: DTS 8.1, 10.1</p>
<p>Consulting room</p> <p>Except where any of the following apply:</p> <ul style="list-style-type: none"> Character Area Overlay Character Preservation District Overlay Coastal Areas Overlay Concept Plans Technical and Numeric Variation Overlay Future Road Widening Overlay Hazards (Bushfire - General Risk) Overlay Hazards (Bushfire - High Risk) Overlay 	<p>[Land Use and Intensity]: DTS 1.2</p> <p>[Built Form and Character]: DTS 3.3, 3.4, 3.5</p> <p>[Interface Height]: DTS 4.1, 4.2</p> <p>[Landscaping]: DTS 5.1, 5.2</p>	<p>Design in Urban Areas [Car Parking Appearance]: DTS 6.4, 6.5</p> <p>Interface Between Land Uses [Hours of Operation]: DTS 2.1</p> <p>Interface Between Land Uses [Overshadowing]: DTS 3.1, 3.2</p> <p>Infrastructure and Renewable Energy Facilities [Water Supply]: DTS 11.1</p> <p>Infrastructure and Renewable Energy Facilities [Wastewater Services]: DTS 12.1, 12.2</p>	<p>None</p>	<p>Airport Building Heights (Aircraft Landing Area): DTS 1.1</p> <p>Airport Building Heights (Regulated): DTS 1.1, 1.2</p> <p>Building Near Airfields: DTS 1.1, 1.2</p> <p>Defence Aviation Area: DTS 1.1, 1.3</p> <p>Future Road Widening: DTS 1.1</p> <p>Key Outback and Rural Routes: DTS 8.1, 10.1</p> <p>Key Railway Crossings: DTS 1.1</p>

Class of Development The following Classes of Development are classified as Deemed-to-Satisfy Development subject to meeting the 'Deemed-to-Satisfy Development Classification Criteria'	Deemed-to-Satisfy Development Classification Criteria Provisions referred to are Deemed-to-Satisfy Criteria Where a development comprises more than one Class of Development the relevant criteria will be taken to be the sum of the criteria for each Class of Development.			
	Zone	General Development Policies	Subzone (applies only in the area affected by the Subzone)	Overlay (applies only in the area affected by the Overlay)
<ul style="list-style-type: none"> • Hazards (Bushfire - Medium Risk) Overlay • Hazards (Bushfire - Regional) Overlay • Hazards (Bushfire - Urban Interface) Overlay • Hazards (Flooding) Overlay • Historic Area Overlay • Local Heritage Place Overlay • Marine Parks (Managed Use) Overlay • Murray Darling Basin Overlay • Non-stop Corridor Overlay • Prescribed Water Resources Area Overlay • Prescribed Watercourses Overlay • Prescribed Wells Area Overlay • River Murray Flood Plain Overlay • River Murray Tributaries Area Overlay • Sloping Land Overlay • State Heritage Area Overlay • State Heritage Place Overlay • Traffic Generating Development Overlay • Water Protection Area Overlay • Water Resources Overlay 		Transport, Access and Parking [Movement Systems]: DTS 1.4 Transport, Access and Parking [Vehicle Access]: DTS 3.1, 3.5, 3.6 Transport, Access and Parking [Vehicle Parking Rates]: DTS 5.1		Major Transport Routes: DTS 8.1, 10.1 Native Vegetation: DTS 1.1, 1.2 State Significant Native Vegetation: DTS 1.1 Urban Transport Routes: DTS 8.1, 10.1 Strategic Infrastructure Gas Pipelines: DTS 2.1
Office Except where any of the following apply: <ul style="list-style-type: none"> • Character Area Overlay • Character Preservation District Overlay • Coastal Areas Overlay • Future Road Widening Overlay • Hazards (Bushfire - General Risk) Overlay • Hazards (Bushfire - High Risk) Overlay 	[Land Use and Intensity]: DTS 1.2 [Built Form and Character]: DTS 3.3, 3.4, 3.5 [Interface Height]: DTS 4.1, 4.2 [Landscaping]: DTS 5.1, 5.2	Design in Urban Areas [Car Parking Appearance]: DTS 6.4, 6.5 Interface Between Land Uses [Hours of Operation]: DTS 2.1 Interface Between Land Uses [Overshadowing]: DTS 3.1, 3.2 Infrastructure and Renewable Energy Facilities [Water Supply]: DTS 11.1 Infrastructure and Renewable Energy Facilities [Wastewater Services]: DTS 12.1, 12.2	None	Airport Building Heights (Aircraft Landing Area): DTS 1.1 Airport Building Heights (Regulated): DTS 1.1, 1.2 Building Near Airfields: DTS 1.1, 1.2 Defence Aviation Area: DTS 1.1, 1.3 Future Road Widening: DTS 1.1 Key Outback and Rural Routes: DTS 8.1, 10.1 Key Railway Crossings: DTS 1.1

Class of Development The following Classes of Development are classified as Deemed-to-Satisfy Development subject to meeting the 'Deemed-to-Satisfy Development Classification Criteria'	Deemed-to-Satisfy Development Classification Criteria Provisions referred to are Deemed-to-Satisfy Criteria Where a development comprises more than one Class of Development the relevant criteria will be taken to be the sum of the criteria for each Class of Development.			
	Zone	General Development Policies	Subzone (applies only in the area affected by the Subzone)	Overlay (applies only in the area affected by the Overlay)
<ul style="list-style-type: none"> • Hazards (Bushfire - Medium Risk) Overlay • Hazards (Bushfire - Regional) Overlay • Hazards (Bushfire - Urban Interface) Overlay • Hazards (Flooding) Overlay • Historic Area Overlay • Local Heritage Place Overlay • Marine Parks (Managed Use) Overlay • Murray Darling Basin Overlay • Non-stop Corridor Overlay • Prescribed Water Resources Area Overlay • Prescribed Watercourses Overlay • Prescribed Wells Area Overlay • River Murray Flood Plain Overlay • River Murray Tributaries Area Overlay • Sloping Land Overlay • State Heritage Area Overlay • State Heritage Place Overlay • Traffic Generating Development Overlay • Water Protection Area Overlay • Water Resources Overlay 		Transport, Access and Parking [Movement Systems]: DTS 1.4 Transport, Access and Parking [Vehicle Access]: DTS 3.1, 3.5, 3.6 Transport, Access and Parking [Vehicle Parking Rates]: DTS 5.1		Major Transport Routes: DTS 8.1, 10.1 Native Vegetation: DTS 1.1, 1.2 State Significant Native Vegetation: DTS 1.1 Urban Transport Routes: DTS 8.1, 10.1 Strategic Infrastructure Gas Pipelines: DTS 2.1

Table 3 – Applicable Policies for Performance Assessed Development

Class of Development	Applicable Policies			
	Zone	General Development Policies	Subzone (applies only in the area affected by the Subzone)	Overlay (applies only in the area affected by the Overlay)
Advertisement	[Advertisements]: PO 7.1	Advertisements [Appearance]: PO 1.1, 1.3, 1.4 Advertisements [Proliferation of Advertisements]: PO 2.1, 2.2 Advertisements [Advertising Content]: PO 3.1 Advertisements [Amenity Content]: PO 4.1 Advertising [Safety]: PO 5.1, 5.2, 5.3, 5.4, 5.5 Clearance from Overhead Powerlines: PO 1.1	None	Advertising Near Signalised Intersections : All Airport Building Heights (Aircraft Landing Area): PO 1.1 Airport Building Heights (Regulated): PO 1.1, 1.2 Building Near Airfields: PO 1.1, 1.2 Character Area : All Character Preservation District : All Coastal Areas : All Defence Aviation Area: PO 1.1, 1.3 Future Road Widening: PO 1.1 Hazards (Flooding) : All Historic Area : All Key Outback and Rural Routes: PO 8.1, 10.1 Key Railway Crossings: PO 1.1 Local Heritage Place : All Major Transport Routes: PO 8.1, 10.1 Marine Parks (Managed Use) : All Murray Darling Basin : All Native Vegetation: PO 1.1, 1.2 Non-stop Corridor : All River Murray Flood Plain : All River Murray Tributaries Area : All Sloping Land : All State Heritage Area : All State Heritage Place : All State Significant Native Vegetation: PO 1.1 Urban Transport Routes: PO 8.1, 10.1 Water Protection Area : All Water Resources : All

Class of Development	Applicable Policies			
	Zone	General Development Policies	Subzone (applies only in the area affected by the Subzone)	Overlay (applies only in the area affected by the Overlay)
Bulky goods outlet	<p>The following policies are applicable to the assessment of the identified Class of Development.</p> <p>Policies referred to are Performance Outcome policies, and any associated Designated Performance Features. Relevant Desired Outcomes are not listed, but automatically apply in relation to a Performance Assessed Development.</p> <p>Where a development comprises more than one Class of Development the relevant policies will be taken to be the sum of the applicable policies for each Class of Development.</p>			
	<p>[Land Use and Intensity]: PO 1.1, 1.2</p> <p>[Built Form and Character]: DTS 3.1, 3.2, 3.3, 3.4, 3.5</p> <p>[Interface Height]: DTS 4.1, 4.2</p> <p>[Landscaping]: DTS 5.2, 5.3</p> <p>[Concept Plans]: PO 8.1</p>	<p>Clearance from Overhead Powerlines: PO 1.1</p> <p>Design in Rural Areas [On-site Waste Treatment Systems]: PO 6.1</p> <p>Design in Urban Areas [All development – External appearance]: PO 1.4, 1.5</p> <p>Design in Urban Areas [All development – Water Sensitive Urban Design]: PO 5.1</p> <p>Design in Urban Areas [Car Parking Appearance]: PO 6.2</p> <p>Design in Urban Areas [All Non-Residential Development – Water Sensitive Design]: PO 42.1</p> <p>Infrastructure and Renewable Energy Facilities [Water Supply]: PO 11.1</p> <p>Infrastructure and Renewable Energy Facilities [Wastewater Services]: PO 12.1, 12.2</p> <p>Interface Between Land Uses [General Land Use Compatibility]: PO 1.2</p> <p>Interface Between Land Uses [Hours of Operation]: PO 2.1</p> <p>Interface Between Land Uses [Activities Generating Noise or Vibration]: PO 4.2</p> <p>Interface Between Land Uses [Light Spill]: PO 6.1, 6.2</p> <p>Transport, Access and Parking [Movement Systems]: PO 1.1, 1.2, 1.3, 1.4</p> <p>Transport, Access and Parking [Sightlines]: PO 2.1, 2.2</p> <p>Transport, Access and Parking [Vehicle Access]: PO 3.1, 3.3, 3.4, 3.5, 3.7, 3.8, 3.9</p> <p>Transport, Access and Parking [Vehicle Parking Rates]: PO 5.1</p> <p>Transport, Access and Parking [Vehicle Parking Areas]: PO 6.1, 6.2, 6.5, 6.6</p>	None	<p>Airport Building Heights (Aircraft Landing Area): PO 1.1</p> <p>Airport Building Heights (Regulated): PO 1.1, 1.2</p> <p>Building Near Airfields: PO 1.1, 1.2</p> <p>Character Preservation District: All</p> <p>Coastal Areas: All</p> <p>Defence Aviation Area: PO 1.1, 1.3</p> <p>Future Road Widening: All</p> <p>Hazards (Bushfire - High Risk): All</p> <p>Hazards (Bushfire - Medium Risk): All</p> <p>Hazards (Bushfire - General Risk): All</p> <p>Hazards (Bushfire - Urban Interface): All</p> <p>Hazards (Bushfire - Regional): All</p> <p>Hazards (Flooding): All</p> <p>Historic Area: All</p> <p>Key Outback and Rural Routes: All</p> <p>Key Railway Crossings: PO 1.1</p> <p>Local Heritage Place: All</p> <p>Major Transport Routes: All</p> <p>Marine Parks (Managed Use): All</p> <p>Murray Darling Basin: All</p> <p>Native Vegetation: PO 1.1, 1.2</p> <p>Non-stop Corridor: All</p> <p>Prescribed Water Resources Area: All</p> <p>Prescribed Watercourses: All</p> <p>Prescribed Wells Area: All</p> <p>River Murray Flood Plain: All</p> <p>River Murray Tributaries Area: All</p> <p>Sloping Land: All</p> <p>State Heritage Area: All</p> <p>State Heritage Place: All</p>

Class of Development	Applicable Policies			
	Zone	General Development Policies	Subzone (applies only in the area affected by the Subzone)	Overlay (applies only in the area affected by the Overlay)
				<p>State Significant Native Vegetation: PO 1.1</p> <p>Strategic Infrastructure Gas Pipelines: All</p> <p>Traffic Generating Development: All</p> <p>Urban Transport Routes: All</p> <p>Water Protection Area: All</p> <p>Water Resources: All</p>
Consulting room	<p>[Land Use and Intensity]: PO 1.1, 1.2</p> <p>[Built Form and Character]: DTS 3.1, 3.2, 3.3, 3.4, 3.5</p> <p>[Interface Height]: DTS 4.1, 4.2</p> <p>[Landscaping]: DTS 5.2, 5.3</p> <p>[Concept Plans]: PO 8.1</p>	<p>Clearance from Overhead Powerlines: PO 1.1</p> <p>Design in Rural Areas [On-site Waste Treatment Systems]: PO 6.1</p> <p>Design in Urban Areas [All development – External appearance]: PO 1.4, 1.5</p> <p>Design in Urban Areas [All development – Water Sensitive Urban Design]: PO 5.1</p> <p>Design in Urban Areas [Car Parking Appearance]: PO 6.2</p> <p>Design in Urban Areas [All Non-Residential Development – Water Sensitive Design]: PO 42.1</p> <p>Infrastructure and Renewable Energy Facilities [Water Supply]: PO 11.1</p> <p>Infrastructure and Renewable Energy Facilities [Wastewater Services]: PO 12.1, 12.2</p> <p>Interface Between Land Uses [General Land Use Compatibility]: PO 1.2</p> <p>Interface Between Land Uses [Hours of Operation]: PO 2.1</p> <p>Interface Between Land Uses [Activities Generating Noise or Vibration]: PO 4.2</p> <p>Interface Between Land Uses [Light Spill]: PO 6.1, 6.2</p> <p>Transport, Access and Parking [Movement Systems]: PO 1.1, 1.2, 1.3, 1.4</p> <p>Transport, Access and Parking [Sightlines]: PO 2.1, 2.2</p> <p>Transport, Access and Parking [Vehicle Access]: PO 3.1, 3.3, 3.4, 3.5, 3.7, 3.8, 3.9</p>	None	<p>Airport Building Heights (Aircraft Landing Area): PO 1.1</p> <p>Airport Building Heights (Regulated): PO 1.1, 1.2</p> <p>Building Near Airfields: PO 1.1, 1.2</p> <p>Character Preservation District: All</p> <p>Coastal Areas: All</p> <p>Defence Aviation Area: PO 1.1, 1.2, 1.3</p> <p>Future Road Widening: All</p> <p>Hazards (Bushfire - High Risk): All</p> <p>Hazards (Bushfire - Medium Risk): All</p> <p>Hazards (Bushfire - General Risk): All</p> <p>Hazards (Bushfire - Urban Interface): All</p> <p>Hazards (Bushfire - Regional): All</p> <p>Hazards (Flooding): All</p> <p>Historic Area: All</p> <p>Key Outback and Rural Routes: All</p> <p>Key Railway Crossings: PO 1.1</p> <p>Local Heritage Place: All</p> <p>Major Transport Routes: All</p> <p>Marine Parks (Managed Use): All</p> <p>Murray Darling Basin: All</p> <p>Native Vegetation: PO 1.1, 1.2</p> <p>Non-stop Corridor: All</p>

Class of Development	Applicable Policies			
	Zone	General Development Policies	Subzone (applies only in the area affected by the Subzone)	Overlay (applies only in the area affected by the Overlay)
		<p>Transport, Access and Parking [Vehicle Parking Rates]: PO 5.1</p> <p>Transport, Access and Parking [Vehicle Parking Areas]: PO 6.1, 6.2, 6.5, 6.6</p>		<p>Prescribed Water Resources Area: All</p> <p>Prescribed Watercourses: All</p> <p>Prescribed Wells Area: All</p> <p>River Murray Flood Plain: All</p> <p>River Murray Tributaries Area: All</p> <p>Sloping Land: All</p> <p>State Heritage Area: All</p> <p>State Heritage Place: All</p> <p>State Significant Native Vegetation: PO 1.1</p> <p>Strategic Infrastructure Gas Pipelines: All</p> <p>Traffic Generating Development: All</p> <p>Urban Transport Routes: All</p> <p>Water Protection Area: All</p> <p>Water Resources: All</p>
Demolition of a State or Local Heritage Place	None	None	None	<p>Local Heritage Place: All</p> <p>State Heritage Place: All</p>
Demolition within an Historic Area Overlay or State Heritage Area Overlay	None	None	None	<p>Historic Area: All</p> <p>State Heritage Area: All</p>
General industry	<p>[Land Use and Intensity]: PO 1.1</p> <p>[Built Form and Character]: DTS 3.1, 3.2, 3.3, 3.4, 3.5</p> <p>[Interface Height]: DTS 4.1, 4.2</p> <p>[Landscaping]: DTS 5.1, 5.2, 5.3</p> <p>[Concept Plans]: PO 8.1</p>	<p>Clearance from Overhead Powerlines: PO 1.1</p> <p>Design in Rural Areas [On-site Waste Treatment Systems]: PO 6.1</p> <p>Design in Urban Areas [All development – External appearance]: PO 1.4, 1.5</p> <p>Design in Urban Areas [All development – Water Sensitive Urban Design]: PO 5.1</p> <p>Design in Urban Areas [Car Parking Appearance]: PO 6.2</p> <p>Design in Urban Areas [All Non-Residential Development – Water Sensitive Design]: PO 42.1</p> <p>Infrastructure and Renewable Energy Facilities [Water Supply]: PO 11.1</p> <p>Infrastructure and Renewable Energy Facilities [Wastewater Services]: PO 12.1, 12.2</p>	None	<p>Airport Building Heights (Aircraft Landing Area): PO 1.1</p> <p>Airport Building Heights (Regulated): PO 1.1, 1.2</p> <p>Building Near Airfields: PO 1.1, 1.2</p> <p>Character Preservation District: All</p> <p>Coastal Areas: All</p> <p>Defence Aviation Area: PO 1.1, 1.2, 1.3</p> <p>Future Road Widening: All</p> <p>Hazards (Bushfire - High Risk): All</p> <p>Hazards (Bushfire - Medium Risk): All</p> <p>Hazards (Bushfire - General Risk): All</p>

Class of Development	Applicable Policies			
	Zone	General Development Policies	Subzone (applies only in the area affected by the Subzone)	Overlay (applies only in the area affected by the Overlay)
		<p>Interface Between Land Uses [General Land Use Compatibility]: PO 1.2</p> <p>Interface Between Land Uses [Hours of Operation]: PO 2.1</p> <p>Interface Between Land Uses [Activities Generating Noise or Vibration]: PO 4.1, 4.2, 4.5</p> <p>Interface Between Land Uses [Air Quality]: PO 5.1, 5.2</p> <p>Interface Between Land Uses [Light Spill]: PO 6.1, 6.2</p> <p>Transport, Access and Parking [Movement Systems]: PO 1.1, 1.2, 1.3, 1.4</p> <p>Transport, Access and Parking [Sightlines]: PO 2.1, 2.2</p> <p>Transport, Access and Parking [Vehicle Access]: PO 3.1, 3.3, 3.4, 3.5, 3.7, 3.8, 3.9</p> <p>Transport, Access and Parking [Vehicle Parking Rates]: PO 5.1</p> <p>Transport, Access and Parking [Vehicle Parking Areas]: PO 6.1, 6.2, 6.5, 6.6</p>		<p>Hazards (Bushfire - Urban Interface): All</p> <p>Hazards (Bushfire - Regional): All</p> <p>Hazards (Flooding): All</p> <p>Historic Area: All</p> <p>Key Outback and Rural Routes: All</p> <p>Key Railway Crossings: PO 1.1</p> <p>Local Heritage Place: All</p> <p>Major Transport Routes: All</p> <p>Marine Parks (Managed Use): All</p> <p>Murray Darling Basin: All</p> <p>Native Vegetation: PO 1.1, 1.2</p> <p>Non-stop Corridor: All</p> <p>Prescribed Water Resources Area: All</p> <p>Prescribed Watercourses: All</p> <p>Prescribed Wells Area: All</p> <p>River Murray Flood Plain: All</p> <p>River Murray Tributaries Area: All</p> <p>Sloping Land: All</p> <p>State Heritage Area: All</p> <p>State Heritage Place: All</p> <p>State Significant Native Vegetation: PO 1.1</p> <p>Strategic Infrastructure Gas Pipelines: All</p> <p>Traffic Generating Development: All</p> <p>Urban Transport Routes: All</p> <p>Water Protection Area: All</p> <p>Water Resources: All</p>
Light industry	<p>[Land Use and Intensity]: PO 1.1, 1.2</p> <p>[Built Form and Character]: DTS 3.1, 3.2, 3.3, 3.4, 3.5</p>	<p>Clearance from Overhead Powerlines: PO 1.1</p> <p>Design in Rural Areas [On-site Waste Treatment Systems]: PO 6.1</p> <p>Design in Urban Areas [All development – External appearance]: PO 1.4, 1.5</p>	None.	<p>Airport Building Heights (Aircraft Landing Area): PO 1.1</p> <p>Airport Building Heights (Regulated): PO 1.1, 1.2</p> <p>Building Near Airfields: PO 1.1, 1.2</p> <p>Character Preservation District: All</p>

Class of Development	Applicable Policies			
	Zone	General Development Policies	Subzone (applies only in the area affected by the Subzone)	Overlay (applies only in the area affected by the Overlay)
	<p>The following policies are applicable to the assessment of the identified Class of Development.</p> <p>Policies referred to are Performance Outcome policies, and any associated Designated Performance Features. Relevant Desired Outcomes are not listed, but automatically apply in relation to a Performance Assessed Development.</p> <p>Where a development comprises more than one Class of Development the relevant policies will be taken to be the sum of the applicable policies for each Class of Development.</p>			
	<p>[Interface Height]: DTS 4.1, 4.2</p> <p>[Landscaping]: DTS 5.1, 5.2, 5.3</p> <p>[Concept Plans]: PO 8.1</p>	<p>Design in Urban Areas [All development – Water Sensitive Urban Design]: PO 5.1</p> <p>Design in Urban Areas [Car Parking Appearance]: PO 6.2</p> <p>Design in Urban Areas [All Non-Residential Development – Water Sensitive Design]: PO 42.1</p> <p>Infrastructure and Renewable Energy Facilities [Water Supply]: PO 11.1</p> <p>Infrastructure and Renewable Energy Facilities [Wastewater Services]: PO 12.1, 12.2</p> <p>Interface Between Land Uses [General Land Use Compatibility]: PO 1.2</p> <p>Interface Between Land Uses [Hours of Operation]: PO 2.1</p> <p>Interface Between Land Uses [Activities Generating Noise or Vibration]: PO 4.1, 4.2, 4.5</p> <p>Interface Between Land Uses [Air Quality]: PO 5.1, 5.2</p> <p>Interface Between Land Uses [Light Spill]: PO 6.1, 6.2</p> <p>Transport, Access and Parking [Movement Systems]: PO 1.1, 1.2, 1.3, 1.4</p> <p>Transport, Access and Parking [Sightlines]: PO 2.1, 2.2</p> <p>Transport, Access and Parking [Vehicle Access]: PO 3.1, 3.3, 3.4, 3.5, 3.7, 3.8, 3.9</p> <p>Transport, Access and Parking [Vehicle Parking Rates]: PO 5.1</p> <p>Transport, Access and Parking [Vehicle Parking Areas]: PO 6.1, 6.2, 6.5, 6.6</p>		<p>Coastal Areas: All</p> <p>Defence Aviation Area: PO 1.1, 1.2, 1.3</p> <p>Future Road Widening: All</p> <p>Hazards (Bushfire - High Risk): All</p> <p>Hazards (Bushfire - Medium Risk): All</p> <p>Hazards (Bushfire - General Risk): All</p> <p>Hazards (Bushfire - Urban Interface): All</p> <p>Hazards (Bushfire - Regional): All</p> <p>Hazards (Flooding): All</p> <p>Historic Area: All</p> <p>Key Outback and Rural Routes: All</p> <p>Key Railway Crossings: PO 1.1</p> <p>Local Heritage Place: All</p> <p>Major Transport Routes: All</p> <p>Marine Parks (Managed Use): All</p> <p>Murray Darling Basin: All</p> <p>Native Vegetation: PO 1.1, 1.2</p> <p>Non-stop Corridor: All</p> <p>Prescribed Water Resources Area: All</p> <p>Prescribed Watercourses: All</p> <p>Prescribed Wells Area: All</p> <p>River Murray Flood Plain: All</p> <p>River Murray Tributaries Area: All</p> <p>Sloping Land: All</p> <p>State Heritage Area: All</p> <p>State Heritage Place: All</p> <p>State Significant Native Vegetation: PO 1.1</p> <p>Strategic Infrastructure Gas Pipelines: All</p> <p>Traffic Generating Development: All</p> <p>Urban Transport Routes: All</p> <p>Water Protection Area: All</p>

Class of Development	Applicable Policies			
	Zone	General Development Policies	Subzone (applies only in the area affected by the Subzone)	Overlay (applies only in the area affected by the Overlay)
				Water Resources: All
Motor repair station	<p>[Land Use and Intensity]: PO 1.1</p> <p>[Built Form and Character]: DTS 3.1, 3.2, 3.3, 3.4, 3.5</p> <p>[Interface Height]: DTS 4.1, 4.2</p> <p>[Landscaping]: DTS 5.1, 5.2, 5.3</p> <p>[Concept Plans]: PO 8.1</p>	<p>Clearance from Overhead Powerlines: PO 1.1</p> <p>Design in Rural Areas [On-site Waste Treatment Systems]: PO 6.1</p> <p>Design in Urban Areas [All development – External appearance]: PO 1.4, 1.5</p> <p>Design in Urban Areas [All development – Water Sensitive Urban Design]: PO 5.1</p> <p>Design in Urban Areas [Car Parking Appearance]: PO 6.2</p> <p>Design in Urban Areas [All Non-Residential Development – Water Sensitive Design]: PO 42.1</p> <p>Infrastructure and Renewable Energy Facilities [Water Supply]: PO 11.1</p> <p>Infrastructure and Renewable Energy Facilities [Wastewater Services]: PO 12.1, 12.2</p> <p>Interface Between Land Uses [General Land Use Compatibility]: PO 1.2</p> <p>Interface Between Land Uses [Hours of Operation]: PO 2.1</p> <p>Interface Between Land Uses [Activities Generating Noise or Vibration]: PO 4.1, 4.2, 4.5</p> <p>Interface Between Land Uses [Air Quality]: PO 5.1</p> <p>Interface Between Land Uses [Light Spill]: PO 6.1, 6.2</p> <p>Transport, Access and Parking [Movement Systems]: PO 1.1, 1.2, 1.3, 1.4</p> <p>Transport, Access and Parking [Sightlines]: PO 2.1, 2.2</p> <p>Transport, Access and Parking [Vehicle Access]: PO 3.1, 3.3, 3.4, 3.5, 3.7, 3.8, 3.9</p> <p>Transport, Access and Parking [Vehicle Parking Rates]: PO 5.1</p> <p>Transport, Access and Parking [Vehicle Parking Areas]: PO 6.1, 6.2, 6.5, 6.6</p>	None.	<p>Airport Building Heights (Aircraft Landing Area): PO 1.1</p> <p>Airport Building Heights (Regulated): PO 1.1, 1.2</p> <p>Building Near Airfields: PO 1.1, 1.2</p> <p>Character Preservation District: All</p> <p>Coastal Areas: All</p> <p>Defence Aviation Area: PO 1.1, 1.2, 1.3</p> <p>Future Road Widening: All</p> <p>Hazards (Bushfire - High Risk): All</p> <p>Hazards (Bushfire - Medium Risk): All</p> <p>Hazards (Bushfire - General Risk): All</p> <p>Hazards (Bushfire - Urban Interface): All</p> <p>Hazards (Bushfire - Regional): All</p> <p>Hazards (Flooding): All</p> <p>Historic Area: All</p> <p>Key Outback and Rural Routes: All</p> <p>Key Railway Crossings: PO 1.1</p> <p>Local Heritage Place: All</p> <p>Major Transport Routes: All</p> <p>Marine Parks (Managed Use): All</p> <p>Murray Darling Basin: All</p> <p>Native Vegetation: PO 1.1, 1.2</p> <p>Non-stop Corridor: All</p> <p>Prescribed Water Resources Area: All</p> <p>Prescribed Watercourses: All</p> <p>Prescribed Wells Area: All</p> <p>River Murray Flood Plain: All</p> <p>River Murray Tributaries Area: All</p> <p>Sloping Land: All</p>

Class of Development	Applicable Policies			
	Zone	General Development Policies	Subzone (applies only in the area affected by the Subzone)	Overlay (applies only in the area affected by the Overlay)
				State Heritage Area: All State Heritage Place: All State Significant Native Vegetation: PO 1.1 Strategic Infrastructure Gas Pipelines: All Traffic Generating Development: All Urban Transport Routes: All Water Protection Area: All Water Resources: All
Office	[Land Use and Intensity]: PO 1.1, 1.2 [Built Form and Character]: DTS 3.1, 3.2, 3.3, 3.4, 3.5 [Interface Height]: DTS 4.1, 4.2 [Landscaping]: DTS 5.2, 5.3 [Concept Plans]: PO 8.1	Clearance from Overhead Powerlines: PO 1.1 Design in Rural Areas [On-site Waste Treatment Systems]: PO 6.1 Design in Urban Areas [All development – External appearance]: PO 1.4, 1.5 Design in Urban Areas [All development – Water Sensitive Urban Design]: PO 5.1 Design in Urban Areas [Car Parking Appearance]: PO 6.2 Design in Urban Areas [All Non-Residential Development – Water Sensitive Design]: PO 42.1 Infrastructure and Renewable Energy Facilities [Water Supply]: PO 11.1 Infrastructure and Renewable Energy Facilities [Wastewater Services]: PO 12.1, 12.2 Interface Between Land Uses [General Land Use Compatibility]: PO 1.2 Interface Between Land Uses [Hours of Operation]: PO 2.1 Interface Between Land Uses [Activities Generating Noise or Vibration]: PO 4.2 Interface Between Land Uses [Light Spill]: PO 6.1, 6.2 Transport, Access and Parking [Movement Systems]: PO 1.1, 1.2, 1.3, 1.4 Transport, Access and Parking [Sightlines]: PO 2.1, 2.2	None	Airport Building Heights (Aircraft Landing Area): PO 1.1 Airport Building Heights (Regulated): PO 1.1, 1.2 Building Near Airfields: PO 1.1, 1.2 Character Preservation District: All Coastal Areas: All Defence Aviation Area: PO 1.1, 1.2, 1.3 Future Road Widening: All Hazards (Bushfire - High Risk): All Hazards (Bushfire - Medium Risk): All Hazards (Bushfire - General Risk): All Hazards (Bushfire - Urban Interface): All Hazards (Bushfire - Regional): All Hazards (Flooding): All Historic Area: All Key Outback and Rural Routes: All Key Railway Crossings: PO 1.1 Local Heritage Place: All Major Transport Routes: All Marine Parks (Managed Use): All Murray Darling Basin: All Native Vegetation: PO 1.1, 1.2

Class of Development	Applicable Policies			
	Zone	General Development Policies	Subzone (applies only in the area affected by the Subzone)	Overlay (applies only in the area affected by the Overlay)
		<p>Transport, Access and Parking [Vehicle Access]: PO 3.1, 3.3, 3.4, 3.5, 3.7, 3.8, 3.9</p> <p>Transport, Access and Parking [Vehicle Parking Rates]: PO 5.1</p> <p>Transport, Access and Parking [Vehicle Parking Areas]: PO 6.1, 6.2, 6.5, 6.6</p>		<p>Non-stop Corridor: All</p> <p>Prescribed Water Resources Area: All</p> <p>Prescribed Watercourses: All</p> <p>Prescribed Wells Area: All</p> <p>River Murray Flood Plain: All</p> <p>River Murray Tributaries Area: All</p> <p>Sloping Land: All</p> <p>State Heritage Area: All</p> <p>State Heritage Place: All</p> <p>State Significant Native Vegetation: PO 1.1</p> <p>Strategic Infrastructure Gas Pipelines: All</p> <p>Traffic Generating Development: All</p> <p>Urban Transport Routes: All</p> <p>Water Protection Area: All</p> <p>Water Resources: All</p>
Personal or domestic services establishment	<p>[Land Use and Intensity]: PO 1.1, 1.2</p> <p>[Built Form and Character]: DTS 3.1, 3.2, 3.3, 3.4, 3.5</p> <p>[Interface Height]: DTS 4.1, 4.2</p> <p>[Landscaping]: DTS 5.2, 5.3</p> <p>[Concept Plans]: PO 8.1</p>	<p>Clearance from Overhead Powerlines: PO 1.1</p> <p>Design in Rural Areas [On-site Waste Treatment Systems]: PO 6.1</p> <p>Design in Urban Areas [All development – External appearance]: PO 1.4, 1.5</p> <p>Design in Urban Areas [All development – Water Sensitive Urban Design]: PO 5.1</p> <p>Design in Urban Areas [Car Parking Appearance]: PO 6.2</p> <p>Design in Urban Areas [All Non-Residential Development – Water Sensitive Design]: PO 42.1</p> <p>Infrastructure and Renewable Energy Facilities [Water Supply]: PO 11.1</p> <p>Infrastructure and Renewable Energy Facilities [Wastewater Services]: PO 12.1, 12.2</p> <p>Interface Between Land Uses [General Land Use Compatibility]: PO 1.2</p> <p>Interface Between Land Uses [Hours of Operation]: PO 2.1</p>	None	<p>Airport Building Heights (Aircraft Landing Area): PO 1.1</p> <p>Airport Building Heights (Regulated): PO 1.1, 1.2</p> <p>Building Near Airfields: PO 1.1, 1.2</p> <p>Character Preservation District: All</p> <p>Coastal Areas: All</p> <p>Defence Aviation Area: PO 1.1, 1.2, 1.3</p> <p>Future Road Widening: All</p> <p>Hazards (Bushfire - High Risk): All</p> <p>Hazards (Bushfire - Medium Risk): All</p> <p>Hazards (Bushfire - General Risk): All</p> <p>Hazards (Bushfire - Urban Interface): All</p> <p>Hazards (Bushfire - Regional): All</p> <p>Hazards (Flooding): All</p>

Class of Development	Applicable Policies			
	Zone	General Development Policies	Subzone (applies only in the area affected by the Subzone)	Overlay (applies only in the area affected by the Overlay)
		<p>Interface Between Land Uses [Activities Generating Noise or Vibration]: PO 4.1, 4.2, 4.5</p> <p>Interface Between Land Uses [Light Spill]: PO 6.1, 6.2</p> <p>Transport, Access and Parking [Movement Systems]: PO 1.1, 1.2, 1.3, 1.4</p> <p>Transport, Access and Parking [Sightlines]: PO 2.1, 2.2</p> <p>Transport, Access and Parking [Vehicle Access]: PO 3.1, 3.3, 3.4, 3.5, 3.7, 3.8, 3.9</p> <p>Transport, Access and Parking [Vehicle Parking Rates]: PO 5.1</p> <p>Transport, Access and Parking [Vehicle Parking Areas]: PO 6.1, 6.2, 6.5, 6.6</p>		<p>Historic Area: All</p> <p>Key Outback and Rural Routes: All</p> <p>Key Railway Crossings: PO 1.1</p> <p>Local Heritage Place: All</p> <p>Major Transport Routes: All</p> <p>Marine Parks (Managed Use): All</p> <p>Murray Darling Basin: All</p> <p>Native Vegetation: PO 1.1, 1.2</p> <p>Non-stop Corridor: All</p> <p>Prescribed Water Resources Area: All</p> <p>Prescribed Watercourses: All</p> <p>Prescribed Wells Area: All</p> <p>River Murray Flood Plain: All</p> <p>River Murray Tributaries Area: All</p> <p>Sloping Land: All</p> <p>State Heritage Area: All</p> <p>State Heritage Place: All</p> <p>State Significant Native Vegetation: PO 1.1</p> <p>Strategic Infrastructure Gas Pipelines: All</p> <p>Traffic Generating Development: All</p> <p>Urban Transport Routes: All</p> <p>Water Protection Area: All</p> <p>Water Resources: All</p>
Retail fuel outlet	<p>[Land Use and Intensity]: PO 1.1, 1.2</p> <p>[Built Form and Character]: DTS 3.1, 3.2, 3.3, 3.4, 3.5</p> <p>[Interface Height]: DTS 4.1, 4.2</p> <p>[Landscaping]: DTS 5.2, 5.3</p> <p>[Concept Plans]: PO 8.1</p>	<p>Clearance from Overhead Powerlines: PO 1.1</p> <p>Design in Rural Areas [On-site Waste Treatment Systems]: PO 6.1</p> <p>Design in Urban Areas [All development – External appearance]: PO 1.4, 1.5</p> <p>Design in Urban Areas [All development – Water Sensitive Urban Design]: PO 5.1</p> <p>Design in Urban Areas [Car Parking Appearance]: PO 6.2</p>	None	<p>Airport Building Heights (Aircraft Landing Area): PO 1.1</p> <p>Airport Building Heights (Regulated): PO 1.1, 1.2</p> <p>Building Near Airfields: PO 1.1, 1.2</p> <p>Character Preservation District: All</p> <p>Coastal Areas: All</p> <p>Defence Aviation Area: PO 1.1, 1.2, 1.3</p> <p>Future Road Widening: All</p>

Class of Development	Applicable Policies			
	Zone	General Development Policies	Subzone (applies only in the area affected by the Subzone)	Overlay (applies only in the area affected by the Overlay)
		<p>The following policies are applicable to the assessment of the identified Class of Development.</p> <p>Policies referred to are Performance Outcome policies, and any associated Designated Performance Features. Relevant Desired Outcomes are not listed, but automatically apply in relation to a Performance Assessed Development.</p> <p>Where a development comprises more than one Class of Development the relevant policies will be taken to be the sum of the applicable policies for each Class of Development.</p>		
		<p>Design in Urban Areas [All Non-Residential Development – Water Sensitive Design]: PO 42.1</p> <p>Infrastructure and Renewable Energy Facilities [Water Supply]: PO 11.1</p> <p>Infrastructure and Renewable Energy Facilities [Wastewater Services]: PO 12.1, 12.2</p> <p>Interface Between Land Uses [General Land Use Compatibility]: PO 1.2</p> <p>Interface Between Land Uses [Hours of Operation]: PO 2.1</p> <p>Interface Between Land Uses [Activities Generating Noise or Vibration]: PO 4.1, 4.2, 4.5</p> <p>Interface Between Land Uses [Air Quality]: PO 5.1, 5.2</p> <p>Interface Between Land Uses [Light Spill]: PO 6.1, 6.2</p> <p>Transport, Access and Parking [Movement Systems]: PO 1.1, 1.2, 1.3, 1.4</p> <p>Transport, Access and Parking [Sightlines]: PO 2.1, 2.2</p> <p>Transport, Access and Parking [Vehicle Access]: PO 3.1, 3.3, 3.4, 3.5, 3.7, 3.8, 3.9</p> <p>Transport, Access and Parking [Vehicle Parking Rates]: PO 5.1</p> <p>Transport, Access and Parking [Vehicle Parking Areas]: PO 6.1, 6.2, 6.5, 6.6</p>		<p>Hazards (Bushfire - High Risk): All</p> <p>Hazards (Bushfire - Medium Risk): All</p> <p>Hazards (Bushfire - General Risk): All</p> <p>Hazards (Bushfire - Urban Interface): All</p> <p>Hazards (Bushfire - Regional): All</p> <p>Hazards (Flooding): All</p> <p>Historic Area: All</p> <p>Key Outback and Rural Routes: All</p> <p>Key Railway Crossings: PO 1.1</p> <p>Local Heritage Place: All</p> <p>Major Transport Routes: All</p> <p>Marine Parks (Managed Use): All</p> <p>Murray Darling Basin: All</p> <p>Native Vegetation: PO 1.1, 1.2</p> <p>Non-stop Corridor: All</p> <p>Prescribed Water Resources Area: All</p> <p>Prescribed Watercourses: All</p> <p>Prescribed Wells Area: All</p> <p>River Murray Flood Plain: All</p> <p>River Murray Tributaries Area: All</p> <p>Sloping Land: All</p> <p>State Heritage Area: All</p> <p>State Heritage Place: All</p> <p>State Significant Native Vegetation: PO 1.1</p> <p>Strategic Infrastructure Gas Pipelines: All</p> <p>Traffic Generating Development: All</p> <p>Urban Transport Routes: All</p> <p>Water Protection Area: All</p> <p>Water Resources: All</p>

Class of Development	Applicable Policies			
	Zone	General Development Policies	Subzone (applies only in the area affected by the Subzone)	Overlay (applies only in the area affected by the Overlay)
	<p>The following policies are applicable to the assessment of the identified Class of Development.</p> <p>Policies referred to are Performance Outcome policies, and any associated Designated Performance Features. Relevant Desired Outcomes are not listed, but automatically apply in relation to a Performance Assessed Development.</p> <p>Where a development comprises more than one Class of Development the relevant policies will be taken to be the sum of the applicable policies for each Class of Development.</p>			
Service trade premises	<p>[Land Use and Intensity]: PO 1.1, 1.2</p> <p>[Built Form and Character]: DTS 3.1, 3.2, 3.3, 3.4, 3.5</p> <p>[Interface Height]: DTS 4.1, 4.2</p> <p>[Landscaping]: DTS 5.2, 5.3</p> <p>[Concept Plans]: PO 8.1</p>	<p>Clearance from Overhead Powerlines: PO 1.1</p> <p>Design in Rural Areas [On-site Waste Treatment Systems]: PO 6.1</p> <p>Design in Urban Areas [All development – External appearance]: PO 1.4, 1.5</p> <p>Design in Urban Areas [All development – Water Sensitive Urban Design]: PO 5.1</p> <p>Design in Urban Areas [Car Parking Appearance]: PO 6.2</p> <p>Design in Urban Areas [All Non-Residential Development – Water Sensitive Design]: PO 42.1</p> <p>Infrastructure and Renewable Energy Facilities [Water Supply]: PO 11.1</p> <p>Infrastructure and Renewable Energy Facilities [Wastewater Services]: PO 12.1, 12.2</p> <p>Interface Between Land Uses [General Land Use Compatibility]: PO 1.2</p> <p>Interface Between Land Uses [Hours of Operation]: PO 2.1</p> <p>Interface Between Land Uses [Activities Generating Noise or Vibration]: PO 4.1, 4.2, 4.5</p> <p>Interface Between Land Uses [Air Quality]: PO 5.1, 5.2</p> <p>Interface Between Land Uses [Light Spill]: PO 6.1, 6.2</p> <p>Transport, Access and Parking [Movement Systems]: PO 1.1, 1.2, 1.3, 1.4</p> <p>Transport, Access and Parking [Sightlines]: PO 2.1, 2.2</p> <p>Transport, Access and Parking [Vehicle Access]: PO 3.1, 3.3, 3.4, 3.5, 3.7, 3.8, 3.9</p> <p>Transport, Access and Parking [Vehicle Parking Rates]: PO 5.1</p> <p>Transport, Access and Parking [Vehicle Parking Areas]: PO 6.1, 6.2, 6.5, 6.6</p>	None	<p>Airport Building Heights (Aircraft Landing Area): PO 1.1</p> <p>Airport Building Heights (Regulated): PO 1.1, 1.2</p> <p>Building Near Airfields: PO 1.1, 1.2</p> <p>Character Preservation District: All</p> <p>Coastal Areas: All</p> <p>Defence Aviation Area: PO 1.1, 1.2, 1.3</p> <p>Future Road Widening: All</p> <p>Hazards (Bushfire - High Risk): All</p> <p>Hazards (Bushfire - Medium Risk): All</p> <p>Hazards (Bushfire - General Risk): All</p> <p>Hazards (Bushfire - Urban Interface): All</p> <p>Hazards (Bushfire - Regional): All</p> <p>Hazards (Flooding): All</p> <p>Historic Area: All</p> <p>Key Outback and Rural Routes: All</p> <p>Key Railway Crossings: PO 1.1</p> <p>Local Heritage Place: All</p> <p>Major Transport Routes: All</p> <p>Marine Parks (Managed Use): All</p> <p>Murray Darling Basin: All</p> <p>Native Vegetation: PO 1.1, 1.2</p> <p>Non-stop Corridor: All</p> <p>Prescribed Water Resources Area: All</p> <p>Prescribed Watercourses: All</p> <p>Prescribed Wells Area: All</p> <p>River Murray Flood Plain: All</p> <p>River Murray Tributaries Area: All</p> <p>Sloping Land: All</p> <p>State Heritage Area: All</p> <p>State Heritage Place: All</p>

Class of Development	Applicable Policies			
	Zone	General Development Policies	Subzone (applies only in the area affected by the Subzone)	Overlay (applies only in the area affected by the Overlay)
				<p>State Significant Native Vegetation: PO 1.1</p> <p>Strategic Infrastructure Gas Pipelines: All</p> <p>Traffic Generating Development: All</p> <p>Urban Transport Routes: All</p> <p>Water Protection Area: All</p> <p>Water Resources: All</p>
<p>Shop</p> <p>Except where any of the following apply:</p> <ul style="list-style-type: none"> The gross leasable floor area is more than 1000m² other than a bulky goods outlet or it is ancillary to an industry 	<p>[Land Use and Intensity]: PO 1.1, 1.2</p> <p>[Built Form and Character]: DTS 3.1, 3.2, 3.3, 3.4, 3.5</p> <p>[Interface Height]: DTS 4.1, 4.2</p> <p>[Landscaping]: DTS 5.2, 5.3</p> <p>[Concept Plans]: PO 8.1</p>	<p>Clearance from Overhead Powerlines: PO 1.1</p> <p>Design in Rural Areas [On-site Waste Treatment Systems]: PO 6.1</p> <p>Design in Urban Areas [All development – External appearance]: PO 1.4, 1.5</p> <p>Design in Urban Areas [All development – Water Sensitive Urban Design]: PO 5.1</p> <p>Design in Urban Areas [Car Parking Appearance]: PO 6.2</p> <p>Design in Urban Areas [All Non-Residential Development – Water Sensitive Design]: PO 42.1</p> <p>Infrastructure and Renewable Energy Facilities [Water Supply]: PO 11.1</p> <p>Infrastructure and Renewable Energy Facilities [Wastewater Services]: PO 12.1, 12.2</p> <p>Interface Between Land Uses [General Land Use Compatibility]: PO 1.2</p> <p>Interface Between Land Uses [Hours of Operation]: PO 2.1</p> <p>Interface Between Land Uses [Activities Generating Noise or Vibration]: PO 4.1, 4.2, 4.5</p> <p>Interface Between Land Uses [Air Quality]: PO 5.1, 5.2</p> <p>Interface Between Land Uses [Light Spill]: PO 6.1, 6.2</p> <p>Transport, Access and Parking [Movement Systems]: PO 1.1, 1.2, 1.3, 1.4</p> <p>Transport, Access and Parking [Sightlines]: PO 2.1, 2.2</p>	None	<p>Airport Building Heights (Aircraft Landing Area): PO 1.1</p> <p>Airport Building Heights (Regulated): PO 1.1, 1.2</p> <p>Building Near Airfields: PO 1.1, 1.2</p> <p>Character Preservation District: All</p> <p>Coastal Areas: All</p> <p>Defence Aviation Area: PO 1.1, 1.2, 1.3</p> <p>Future Road Widening: All</p> <p>Hazards (Bushfire - High Risk): All</p> <p>Hazards (Bushfire - Medium Risk): All</p> <p>Hazards (Bushfire - General Risk): All</p> <p>Hazards (Bushfire - Urban Interface): All</p> <p>Hazards (Bushfire - Regional): All</p> <p>Hazards (Flooding): All</p> <p>Historic Area: All</p> <p>Key Outback and Rural Routes: All</p> <p>Key Railway Crossings: PO 1.1</p> <p>Local Heritage Place: All</p> <p>Major Transport Routes: All</p> <p>Marine Parks (Managed Use): All</p> <p>Murray Darling Basin: All</p> <p>Native Vegetation: PO 1.1, 1.2</p> <p>Non-stop Corridor: All</p>

Class of Development	Applicable Policies			
	Zone	General Development Policies	Subzone (applies only in the area affected by the Subzone)	Overlay (applies only in the area affected by the Overlay)
		<p>Transport, Access and Parking [Vehicle Access]: PO 3.1, 3.3, 3.4, 3.5, 3.7, 3.8, 3.9</p> <p>Transport, Access and Parking [Vehicle Parking Rates]: PO 5.1</p> <p>Transport, Access and Parking [Vehicle Parking Areas]: PO 6.1, 6.2, 6.5, 6.6</p>		<p>Prescribed Water Resources Area: All</p> <p>Prescribed Watercourses: All</p> <p>Prescribed Wells Area: All</p> <p>River Murray Flood Plain: All</p> <p>River Murray Tributaries Area: All</p> <p>Sloping Land: All</p> <p>State Heritage Area: All</p> <p>State Heritage Place: All</p> <p>State Significant Native Vegetation: PO 1.1</p> <p>Strategic Infrastructure Gas Pipelines: All</p> <p>Traffic Generating Development: All</p> <p>Urban Transport Routes: All</p> <p>Water Protection Area: All</p> <p>Water Resources: All</p>
Store	<p>[Land Use and Intensity]: PO 1.1, 1.2</p> <p>[Built Form and Character]: DTS 3.1, 3.2, 3.3, 3.4, 3.5</p> <p>[Interface Height]: DTS 4.1, 4.2</p> <p>[Landscaping]: DTS 5.2, 5.3</p> <p>[Concept Plans]: PO 8.1</p>	<p>Clearance from Overhead Powerlines: PO 1.1</p> <p>Design in Rural Areas [On-site Waste Treatment Systems]: PO 6.1</p> <p>Design in Urban Areas [All development – External appearance]: PO 1.4, 1.5</p> <p>Design in Urban Areas [All development – Water Sensitive Urban Design]: PO 5.1</p> <p>Design in Urban Areas [Car Parking Appearance]: PO 6.2</p> <p>Design in Urban Areas [All Non-Residential Development – Water Sensitive Design]: PO 42.1</p> <p>Infrastructure and Renewable Energy Facilities [Water Supply]: PO 11.1</p> <p>Infrastructure and Renewable Energy Facilities [Wastewater Services]: PO 12.1, 12.2</p> <p>Interface Between Land Uses [General Land Use Compatibility]: PO 1.2</p> <p>Interface Between Land Uses [Hours of Operation]: PO 2.1</p>	None	<p>Airport Building Heights (Aircraft Landing Area): PO 1.1</p> <p>Airport Building Heights (Regulated): PO 1.1, 1.2</p> <p>Building Near Airfields: PO 1.1, 1.2</p> <p>Character Preservation District: All</p> <p>Coastal Areas: All</p> <p>Defence Aviation Area: PO 1.1, 1.2, 1.3</p> <p>Future Road Widening: All</p> <p>Hazards (Bushfire - High Risk): All</p> <p>Hazards (Bushfire - Medium Risk): All</p> <p>Hazards (Bushfire - General Risk): All</p> <p>Hazards (Bushfire - Urban Interface): All</p> <p>Hazards (Bushfire - Regional): All</p> <p>Hazards (Flooding): All</p> <p>Historic Area: All</p>

Class of Development	Applicable Policies			
	Zone	General Development Policies	Subzone (applies only in the area affected by the Subzone)	Overlay (applies only in the area affected by the Overlay)
		<p>Interface Between Land Uses [Activities Generating Noise or Vibration]: PO 4.1, 4.2, 4.5</p> <p>Interface Between Land Uses [Light Spill]: PO 6.1, 6.2</p> <p>Transport, Access and Parking [Movement Systems]: PO 1.1, 1.2, 1.3, 1.4</p> <p>Transport, Access and Parking [Sightlines]: PO 2.1, 2.2</p> <p>Transport, Access and Parking [Vehicle Access]: PO 3.1, 3.3, 3.4, 3.5, 3.7, 3.8, 3.9</p> <p>Transport, Access and Parking [Vehicle Parking Rates]: PO 5.1</p> <p>Transport, Access and Parking [Vehicle Parking Areas]: PO 6.1, 6.2, 6.5, 6.6</p>		<p>Key Outback and Rural Routes: All</p> <p>Key Railway Crossings: PO 1.1</p> <p>Local Heritage Place: All</p> <p>Major Transport Routes: All</p> <p>Marine Parks (Managed Use): All</p> <p>Murray Darling Basin: All</p> <p>Native Vegetation: PO 1.1, 1.2</p> <p>Non-stop Corridor: All</p> <p>Prescribed Water Resources Area: All</p> <p>Prescribed Watercourses: All</p> <p>Prescribed Wells Area: All</p> <p>River Murray Flood Plain: All</p> <p>River Murray Tributaries Area: All</p> <p>Sloping Land: All</p> <p>State Heritage Area: All</p> <p>State Heritage Place: All</p> <p>State Significant Native Vegetation: PO 1.1</p> <p>Strategic Infrastructure Gas Pipelines: All</p> <p>Traffic Generating Development: All</p> <p>Urban Transport Routes: All</p> <p>Water Protection Area: All</p> <p>Water Resources: All</p>
Telecommunications facility	[Land Use and Intensity]: PO 1.1	<p>Infrastructure and Renewable Energy Facilities [Telecommunication Facilities]: PO 6.1, 6.2</p>	None	<p>Advertising Near Signalised Intersections : All</p> <p>Airport Building Heights (Aircraft Landing Area): PO 1.1</p> <p>Airport Building Heights (Regulated): PO 1.1, 1.2</p> <p>Building Near Airfields: PO 1.1, 1.2</p> <p>Character Area : All</p> <p>Character Preservation District : All</p> <p>Coastal Areas : All</p> <p>Defence Aviation Area: PO 1.1, 1.3</p>

Class of Development	Applicable Policies			
	Zone	General Development Policies	Subzone (applies only in the area affected by the Subzone)	Overlay (applies only in the area affected by the Overlay)
				<p>Future Road Widening: PO 1.1</p> <p>Hazards (Flooding) : All</p> <p>Historic Area : All</p> <p>Key Outback and Rural Routes: PO 8.1, 10.1</p> <p>Key Railway Crossings: PO 1.1</p> <p>Local Heritage Place : All</p> <p>Major Transport Routes: PO 8.1, 10.1</p> <p>Marine Parks (Managed Use) : All</p> <p>Murray Darling Basin : All</p> <p>Native Vegetation: PO 1.1, 1.2</p> <p>Non-stop Corridor : All</p> <p>River Murray Flood Plain : All</p> <p>River Murray Tributaries Area : All</p> <p>Sloping Land : All</p> <p>State Heritage Area : All</p> <p>State Heritage Place : All</p> <p>State Significant Native Vegetation: PO 1.1</p> <p>Urban Transport Routes: PO 8.1, 10.1</p> <p>Water Protection Area : All</p> <p>Water Resources : All</p>
Tree damaging activity	None	None	None	Regulated Tree: All
Warehouse	<p>[Land Use and Intensity]: PO 1.1, 1.2</p> <p>[Built Form and Character]: DTS 3.1, 3.2, 3.3, 3.4, 3.5</p> <p>[Interface Height]: DTS 4.1, 4.2</p> <p>[Landscaping]: DTS 5.2, 5.3</p> <p>[Concept Plans]: PO 8.1</p>	<p>Clearance from Overhead Powerlines: PO 1.1</p> <p>Design in Rural Areas [On-site Waste Treatment Systems]: PO 6.1</p> <p>Design in Urban Areas [All development – External appearance]: PO 1.4, 1.5</p> <p>Design in Urban Areas [All development – Water Sensitive Urban Design]: PO 5.1</p> <p>Design in Urban Areas [Car Parking Appearance]: PO 6.2</p> <p>Design in Urban Areas [All Non-Residential Development – Water Sensitive Design]: PO 42.1</p>	None	<p>Airport Building Heights (Aircraft Landing Area): PO 1.1</p> <p>Airport Building Heights (Regulated): PO 1.1, 1.2</p> <p>Building Near Airfields: PO 1.1, 1.2</p> <p>Character Preservation District: All</p> <p>Coastal Areas: All</p> <p>Defence Aviation Area: PO 1.1, 1.2, 1.3</p> <p>Future Road Widening: All</p> <p>Hazards (Bushfire - High Risk): All</p>

Class of Development	Applicable Policies			
	Zone	General Development Policies	Subzone (applies only in the area affected by the Subzone)	Overlay (applies only in the area affected by the Overlay)
		<p>Infrastructure and Renewable Energy Facilities [Water Supply]: PO 11.1</p> <p>Infrastructure and Renewable Energy Facilities [Wastewater Services]: PO 12.1, 12.2</p> <p>Interface Between Land Uses [General Land Use Compatibility]: PO 1.2</p> <p>Interface Between Land Uses [Hours of Operation]: PO 2.1</p> <p>Interface Between Land Uses [Activities Generating Noise or Vibration]: PO 4.1, 4.2, 4.5</p> <p>Interface Between Land Uses [Light Spill]: PO 6.1, 6.2</p> <p>Transport, Access and Parking [Movement Systems]: PO 1.1, 1.2, 1.3, 1.4</p> <p>Transport, Access and Parking [Sightlines]: PO 2.1, 2.2</p> <p>Transport, Access and Parking [Vehicle Access]: PO 3.1, 3.3, 3.4, 3.5, 3.7, 3.8, 3.9</p> <p>Transport, Access and Parking [Vehicle Parking Rates]: PO 5.1</p> <p>Transport, Access and Parking [Vehicle Parking Areas]: PO 6.1, 6.2, 6.5, 6.6</p>		<p>Hazards (Bushfire - Medium Risk): All</p> <p>Hazards (Bushfire - General Risk): All</p> <p>Hazards (Bushfire - Urban Interface): All</p> <p>Hazards (Bushfire - Regional): All</p> <p>Hazards (Flooding): All</p> <p>Historic Area: All</p> <p>Key Outback and Rural Routes: All</p> <p>Key Railway Crossings: PO 1.1</p> <p>Local Heritage Place: All</p> <p>Major Transport Routes: All</p> <p>Marine Parks (Managed Use): All</p> <p>Murray Darling Basin: All</p> <p>Native Vegetation: PO 1.1, 1.2</p> <p>Non-stop Corridor: All</p> <p>Prescribed Water Resources Area: All</p> <p>Prescribed Watercourses: All</p> <p>Prescribed Wells Area: All</p> <p>River Murray Flood Plain: All</p> <p>River Murray Tributaries Area: All</p> <p>Sloping Land: All</p> <p>State Heritage Area: All</p> <p>State Heritage Place: All</p> <p>State Significant Native Vegetation: PO 1.1</p> <p>Strategic Infrastructure Gas Pipelines: All</p> <p>Traffic Generating Development: All</p> <p>Urban Transport Routes: All</p> <p>Water Protection Area: All</p> <p>Water Resources: All</p>
All other Code Assessed Development	All	All	None	Any Relevant Overlay: All

Table 4 – Restricted Development Classification

Class of Development The following Classes of Development are classified as Restricted subject to any 'Exclusions'	Exclusions
Industry	Special Industry
Shop	Where: <ul style="list-style-type: none"> (a) the gross leasable floor area is no more than 1000m²: or (b) it is a bulky goods outlet; or (c) it is ancillary to an industry on the same allotment.

Assessment Provisions (AP)

Desired Outcomes (DO)

DO 1

A comprehensive range of industrial, logistical, warehousing, storage, research and training land uses together with compatible business activities generating wealth and employment for the State.

DO 2

Employment generating uses are arranged to:

- (a) support the efficient movement of goods and materials on land in the vicinity of major transport infrastructure such as ports and intermodal freight facilities;
- (b) maintain access to waterfront areas for uses that benefit from direct water access including harbour facilities, port related industry and warehousing, ship building and related support industries;
- (c) create new and enhance existing business clusters;
- (d) support opportunities for the convenient co-location of rural related industries and allied businesses that may detract from scenic rural landscapes; and
- (e) be compatible with its location and setting to manage adverse impacts on the amenity of land in adjacent zones.

DO 3

Development achieves a pleasant visual amenity when viewed from adjacent arterial roads, adjoining zones and entrance ways to cities, towns and settlements.

Performance Outcomes and Deemed to Satisfy / Designated Performance Outcome Criteria

Land Use and Intensity

PO 1.1

Development primarily for a range of higher impacting land uses including general industry, warehouse, transport distribution and the like supplemented by other compatible development so as not to unduly impede the use of land in other ownership in the zone for employment generating land uses, particularly those parts of the zone unaffected by an interface with another zone that would be sensitive impact generating uses.

DTS/DPF 1.1

Development comprises one or more of the following land uses:

- Automotive collision repair
- Electricity substation
- Fuel depot
- General industry
- Light Industry
- Motor repair station
- Public service depot
- Retail fuel outlet
- Service trade premises
- Shop
- Store
- Telecommunications facility
- Training facility
- Warehouse

PO 1.2

Development adjacent land in another zone used for or primarily accommodating residential development incorporates a range of low impact non-residential uses to mitigate adverse amenity and safety impacts on the adjoining zone.

DTS/DPF 1.2

Development involving any of the following uses on a site adjacent land in another zone used for or expected to be primarily used for residential purposes:

- Bulky goods outlet
- Consulting room
- Indoor recreation facility
- Light industry
- Office
- Research facility
- Service trade premises
- Store
- Training facility.

PO 1.3

Shops, other than a bulky goods outlet and shops not ancillary to an industry, primarily cater to the surrounding workforce to enhance the amenity of the zone for those workers.

DTS/DPF 1.3

Shop:

- (a) with a gross leasable floor area up to 500m²;
- (b) in the form of a bulky goods outlet; or
- (c) ancillary to and located on the same allotment as an industry.

PO 1.4

Residential development is subordinate and necessary to support the efficient management, security and/or operational aspects of a non-residential land use.

DTS/DPF 1.4

None are applicable.

Site Dimensions and Land Division

PO 2.1

Land division creating allotments of a size and shape suitable for a range of industrial, transport, warehouse and other similar or complementary land uses that support employment generation.

DTS/DPF 2.1

Allotments have:

- (a) an area of 2500m² or more; and
- (b) a frontage width of 30m or more.

Built Form and Character

PO 3.1

Development that achieves distinctive building, landscape and streetscape design to achieve high visual and environmental amenity particularly along arterial roads, zone boundaries and public open spaces.

DTS/DPF 3.1

None are applicable.

PO 3.2

Building facades facing a boundary of a zone primarily intended to accommodate sensitive receivers, public road, or public open space incorporate design elements to add visual interest by considering the following:

- (a) a variety of building finishes and avoid elevations that consist solely of metal cladding;
- (b) using materials with a low reflectivity; and
- (c) techniques to add visual interest and reduce large expanses of blank walls including modulation and incorporation of offices and showrooms along elevations visible to a public road.

DTS/DPF 3.2

None are applicable.

PO 3.3

Buildings set back from the primary street boundary to contribute to a consistent streetscape.

DTS/DPF 3.3

Buildings are no closer to the primary street frontage than:

- (a) the average of existing buildings on adjoining sites with the same primary street frontage and, if there is only one such building, the setback of that building; or
- (b) where no building exists on an adjoining site.
 - i. 8m or more for buildings up to 6m high;
 - ii. not less than 10m for buildings greater than 6m high.

PO 3.4

Buildings setback from secondary street boundaries to accommodate the provision of landscaping between buildings and the road to enhance the appearance of land and buildings when viewed from the street.

DTS/DPF 3.4

Buildings setback 4m or more from a secondary street boundary.

PO 3.5

Buildings are sited to accommodate vehicle access to the rear of a site for deliveries, maintenance and emergency purposes.

DTS/DPF 3.5

Buildings setback 3m or more from at least one side boundary, unless an alternative means for vehicular access to the rear of the site is available.

Interface Height

PO 4.1

Buildings mitigate visual impacts of building massing on residential development within a neighbourhood zone.

DTS/DPF 4.1

Buildings constructed within a building envelope provided by a 45 degree plane measured from a height of 3 metres above natural ground level at the allotment boundary of a residential allotment within a neighbourhood zone as shown in the following diagram (except where this boundary is a southern boundary in which case DTS/DPF 4.2 will apply, or where this boundary is the primary street boundary):

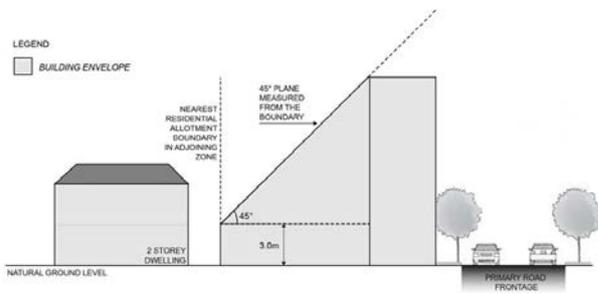

PO 4.2

Buildings mitigate overshadowing of residential development within a neighbourhood zone.

DTS/DPF 4.2

Buildings on sites with a southern boundary adjoining a residential allotment within a neighbourhood zone are constructed within a building envelope provided by a 30 degree plane grading north measured from a height of 3m above natural ground level at the southern boundary, as shown in the following diagram:

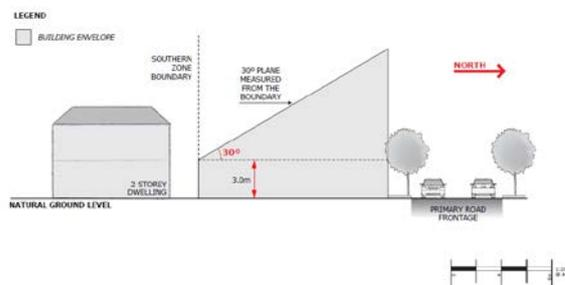

Landscaping

PO 5.1

Landscaping provided along public roads and thoroughfares and zone boundaries to enhance the visual appearance of development and soften the impact of larger buildings when viewed from public spaces and adjacent land outside the zone.

DTS/DPF 5.1

Other than to accommodate a lawfully existing or authorised driveway or access point or an access point for which consent has been granted as part of an application for the division of land, a landscaped area is provided within the development site (excluding any land required for road widening purposes):

- (a) where a building is setback less than 3m from the street boundary - within the area remaining between a relevant building and the street boundary; or
- (b) in accordance with the following:

Minimum width	Description
5m	Along any boundary with a Highway, Freeway or Expressway.
5m	Along any boundary on the perimeter of the zone not fronting a public road or thoroughfare, except where the adjacent zone is one of the following: <ul style="list-style-type: none"> (a) → Employment (Bulk Handling) Zone; (b) → Suburban Employment Zone; (c) → Resource Extraction Zone.
3m	Along any boundary on the perimeter of the zone that fronts a public road or thoroughfare.
3m	Along an arterial or main road frontage within the zone (and not on the perimeter of the zone)

PO 5.2

Development incorporates areas for landscaping to enhance the overall amenity of the site and locality.

DTS/DPF 5.2

Landscape areas comprise:

- (a) not less than 10 percent of the site; and
- (b) a dimension of at least 1.5m.

PO 5.3

Landscape areas incorporate a range of plant species of varying heights at maturity, including tree species with a canopy above clear stems, to complement the scale of relevant buildings.

DTS/DPF 5.3

None are applicable.

Fencing

PO 6.1

Fencing exceeding 2.1m in height integrated and designed to complement the appearance of land and buildings and does not form a dominant visual feature from adjacent streets to enhance the character of employment areas.

DTS/DPF /DPF 6.1

Fencing exceeding 2.1m in height:

- (a) located behind a façade of an associated building located on the same site; or
- (b) located behind a landscaped area along relevant street frontages; or
- (c) consists of visually permeable materials with landscaping behind.

Advertisements

PO 7.1

Freestanding advertisements do not create a visually dominant element within the locality.

DTS/DPF /DPF 7.1

Freestanding advertisements:

- (a) do not exceed 6m in height; and
- (b) do not have a sign face exceeding 8m² per side.

Procedural Matters (PM)

Notification

All classes of performance assessed development are excluded from notification except where they involve any of the following:

- (a) the site of the development is adjacent land to land in a different zone
- (b) development identified as "all other code assessed development" in Employment Zone Table 3
- (c) dwelling
- (d) pre-school
- (e) bulky goods outlet
- (f) shop exceeding 500m² other than where associated with an industry on the same allotment
- (g) tourist accommodation.

Placement of Notices – Exemptions for Performance Assessed Development

None specified.

Placement of Notices – Exemptions for Restricted Development

None specified.

Infrastructure Zone

Table 1 – Accepted Development Classification

Class of Development The following Classes of Development are classified as Accepted Development subject to meeting the 'Accepted Development Classification Criteria'	Accepted Development Classification Criteria
Building work on railway land	1 Building work is associated with a railway 2 It is situated (or to be situated) on railway land 3 It is required for the conduct or maintenance of railway activities.
Carport Except where any of the following apply: <ul style="list-style-type: none"> • Character Preservation District Overlay • Coastal Areas Overlay • Hazards (Flooding) Overlay • Historic Area Overlay • Historic Shipwrecks Overlay • Local Heritage Place Overlay • State Heritage Place Overlay • Native Vegetation Overlay • State Significant Native Vegetation Overlay • Ramsar Wetlands Overlay • River Murray Flood Plain Overlay • Sloping Land Overlay • Key Railway Crossings Overlay where an existing access is altered or a new access is created • Key Outback and Rural Routes Overlay where an 	1 The development will not be built, or encroach, on an area that is, or will be, required for a sewerage system or waste control system 2 It is ancillary to an office erected on the site 3 Primary street setback – at least 5.5m from the primary street boundary and as far back as the building line of the building to which it is ancillary 4 Secondary street setback – at least 900mm from the boundary of the allotment (if the land has boundaries on two or more roads) 5 Total floor area - does not exceed 40m ² 6 Post height - does not exceed 3m measured from natural ground level (and not including a gable end) 7 Building height - does not exceed 5m 8 If situated on or abutting a boundary (not being a boundary with a primary street or secondary street) – a length not exceeding 10m unless: <ul style="list-style-type: none"> (a) a longer wall or structure exists on the adjacent site and is situated on the same allotment boundary; and (b) the proposed wall or structure will be built along the same length of boundary as the existing adjacent wall or structure to the same or lesser extent 9 If the carport abuts or is situated on the boundary of the allotment (not being a boundary with a primary street or secondary street): <ul style="list-style-type: none"> (a) it will not result in all relevant walls or structures located along the boundary exceeding 45% of the length of the boundary; and (b) it will not be located within 3m of any other wall along the same boundary unless on an adjacent site on that

<p>existing access is altered or a new access is created</p> <ul style="list-style-type: none"> Major Urban Transport Routes Overlay where an existing access is altered or a new access is created Urban Transport Routes Overlay where an existing access is altered or a new access is created Water Resources Overlay 	<p>boundary there is an existing wall of a building that would be adjacent to or abut the proposed wall or structure</p> <p>10 The total roofed area of all existing or proposed buildings on the allotment does not exceed 60% of the area of the allotment</p> <p>11 Door opening for vehicle access – does not exceed, in total, 7m in width or 50% of the width of the allotment frontage (whichever lesser)</p> <p>12 Internal dimensions – does not exceed 3.2m in width and 6m in length between all fences, walls and doors</p> <p>13 The carport:</p> <p>(a) is located so that vehicle access:</p> <p>i. is provided via a lawfully existing or authorised driveway or access point or an access point for which consent has been granted as part of an application for the division of land; or</p> <p>ii. will use a driveway that:</p> <p>A. is not located within 6 metres of an intersection of 2 or more roads or a pedestrian actuated crossing; and</p> <p>B. will not interfere with an item of street furniture (including directional signs, lighting, seating and weather shelters), other infrastructure, or a tree; or</p> <p>iii. if adjacent a kerbed road, will be via a kerb that is designed to allow a vehicle to roll over it; and</p> <p>(b) is located so that the gradient from the place of access on the boundary of the allotment to the finished floor level at the front of the carport when the work is completed is not steeper than 1:4 on average; and</p> <p>The centre of the driveway at the public road boundary is no more than 25 degree deviation from the centre of the front of the covered car parking space for which it provides vehicle access</p>
<p>Internal building work</p> <p>Except where any of the following apply:</p> <ul style="list-style-type: none"> A Local Heritage Place identified in the Local Heritage Place Overlay A State Heritage Place identified in the State Heritage Place Overlay 	<p>1 There will be no increase in the total floor area of the building</p> <p>2 There will be no alteration to the external appearance of the building.</p>
<p>Solar photovoltaic panels (roof mounted)</p> <p>Except where any of the following apply:</p>	<p>1 Panels are installed parallel to the roof of a building and with the underside surface of the panel not being more than 100mm above the surface of the roof</p>

<ul style="list-style-type: none"> • A Local Heritage Place identified in the Local Heritage Place Overlay • A State Heritage Place identified in the State Heritage Place Overlay 	<ol style="list-style-type: none"> 2 Panels and associated components do not overhang any part of the roof 3 Does not apply to system with a generating capacity of more than 5MW that is to be connected to the State's power system.
<p>Water tank (above ground) Except where any of the following apply:</p> <ul style="list-style-type: none"> • Character Preservation District Overlay • Coastal Areas Overlay • Hazards (Flooding) Overlay • Local Heritage Place Overlay • State Heritage Place Overlay • Native Vegetation Overlay • State Significant Native Vegetation Overlay • River Murray Flood Plain Overlay • Sloping Land Overlay 	<ol style="list-style-type: none"> 1 The development will not be built, or encroach, on an area that is, or will be, required for a sewerage system or waste control system 2 The tank is part of a roof drainage system 3 Total floor area - not exceeding 15m² 4 The tank is located wholly above ground 5 Tank height – does not exceed 4m above natural ground level 6 Primary street setback – at least as far back as the building line of the building to which it is ancillary 7 In the case of a tank made of metal – the tank is pre-colour treated or painted in a non-reflective colour.
<p>Water tank (underground) Except where any of the following apply:</p> <ul style="list-style-type: none"> • Character Preservation District Overlay • Coastal Areas Overlay • Native Vegetation Overlay • State Significant Native Vegetation Overlay • Sloping Land Overlay 	<ol style="list-style-type: none"> 1 The development will not be built, or encroach, on an area that is, or will be, required for a sewerage system or waste control system 2 The tank (including any associated pump) is located wholly below the level of the ground.

Table 2 – Deemed-to-Satisfy Development Classification

The following Classes of Development are classified as Deemed-to-Satisfy Development subject to meeting the 'Deemed-to-Satisfy Development Classification Criteria'	Deemed-to-Satisfy Development Classification Criteria			
	Provisions referred to are Deemed-to-Satisfy Criteria Where a development comprises more than one Class of Development the relevant criteria will be taken to be the sum of the criteria for each Class of Development.			
None Specified			(applies only in the area affected by the Subzone)	(applies only in the area affected by the Overlay)

Table 3 – Applicable Policies for Performance Assessed Development

	<p>The following policies are applicable to the assessment of the identified Class of Development. Policies referred to are Performance Outcome policies, and any associated Designated Performance Features. Relevant Desired Outcomes are not listed, but automatically apply in relation to a Performance Assessed Development.</p> <p>Where a development comprises more than one Class of Development the relevant policies will be taken to be the sum of the applicable policies for each Class of Development.</p>			
			(applies only in the area affected by the Subzone)	(applies only in the area affected by the Overlay)
Demolition of a State or Local Heritage Place	None	None	None	Local Heritage Place: All State Heritage Place: All
Office	[Land Use and Intensity]: PO 1.1, 1.2, 1.3	<p>Clearance from Overhead Powerlines: PO 1.1</p> <p>Design in Rural Areas [On-site Waste Treatment Systems]: PO 6.1</p> <p>Design in Urban Areas [All development – External appearance]: PO 1.4, 1.5</p> <p>Design in Urban Areas [All development – Water Sensitive Urban Design]: PO 5.1</p> <p>Design in Urban Areas [Car Parking Appearance]: PO 6.2</p>	None	<p>Airport Building Heights (Aircraft Landing Area): PO 1.1</p> <p>Airport Building Heights (Regulated): PO 1.1, 1.2</p> <p>Building Near Airfields: PO 1.1, 1.2</p> <p>Character Preservation District: All</p> <p>Coastal Areas: All</p> <p>Defence Aviation Area: PO 1.1, 1.3</p> <p>Hazards (Bushfire - General Risk): All</p>

The following policies are applicable to the assessment of the identified Class of Development. Policies referred to are Performance Outcome policies, and any associated Designated Performance Features. Relevant Desired Outcomes are not listed, but automatically apply in relation to a Performance Assessed Development.

Where a development comprises more than one Class of Development the relevant policies will be taken to be the sum of the applicable policies for each Class of Development.

			(applies only in the area affected by the Subzone)	(applies only in the area affected by the Overlay)
		<p>Design in Urban Areas [All Non-Residential Development – Water Sensitive Design]: PO 42.1</p> <p>Infrastructure and Renewable Energy Facilities [Water Supply]: PO 11.1</p> <p>Infrastructure and Renewable Energy Facilities [Wastewater Services]: PO 12.1, 12.2</p> <p>Interface Between Land Uses [General Land Use Compatibility]: PO 1.2</p> <p>Interface Between Land Uses [Hours of Operation]: PO 2.1</p> <p>Interface Between Land Uses [Activities Generating Noise or Vibration]: PO 4.2</p>		<p>Hazards (Bushfire - High Risk): All</p> <p>Hazards (Bushfire - Medium Risk): All</p> <p>Hazards (Bushfire - Regional): All</p> <p>Hazards (Flooding): All</p> <p>Historic Shipwrecks: All</p> <p>Key Outback and Rural Routes: All</p> <p>Key Railway Crossings: PO 1.1</p> <p>Local Heritage Place: All</p> <p>Mt Lofty Ranges Catchment (Area 1): All</p> <p>Mt Lofty Ranges Catchment (Area 2): All</p> <p>Murray Darling Basin: All</p>

The following policies are applicable to the assessment of the identified Class of Development. Policies referred to are Performance Outcome policies, and any associated Designated Performance Features. Relevant Desired Outcomes are not listed, but automatically apply in relation to a Performance Assessed Development.

Where a development comprises more than one Class of Development the relevant policies will be taken to be the sum of the applicable policies for each Class of Development.

			(applies only in the area affected by the Subzone)	(applies only in the area affected by the Overlay)
		<p>Interface Between Land Uses [Light Spill]: PO 6.1, 6.2</p> <p>Transport, Access and Parking [Movement Systems]: PO 1.1, 1.2, 1.3, 1.4</p> <p>Transport, Access and Parking [Sightlines]: PO 2.1, 2.2</p> <p>Transport, Access and Parking [Vehicle Access]: PO 3.1, 3.3, 3.4, 3.5, 3.7, 3.8, 3.9</p> <p>Transport, Access and Parking [Vehicle Parking Rates]: PO 5.1</p> <p>Transport, Access and Parking [Vehicle Parking Areas]: PO 6.1, 6.2, 6.5, 6.6</p>		<p>Native Vegetation: PO 1.1, 1.2</p> <p>Prescribed Water Resources Area: All</p> <p>Prescribed Wells Area: All</p> <p>River Murray Flood Plain: All</p> <p>Sloping Land: All</p> <p>State Heritage Place: All</p> <p>State Significant Native Vegetation: PO 1.1</p> <p>Strategic Infrastructure Gas Pipelines: All</p> <p>Traffic Generating Development: All</p> <p>Urban Transport Routes: All</p>

The following policies are applicable to the assessment of the identified Class of Development. Policies referred to are Performance Outcome policies, and any associated Designated Performance Features. Relevant Desired Outcomes are not listed, but automatically apply in relation to a Performance Assessed Development.

Where a development comprises more than one Class of Development the relevant policies will be taken to be the sum of the applicable policies for each Class of Development.

			(applies only in the area affected by the Subzone)	(applies only in the area affected by the Overlay)
				Water Protection Area: All Water Resources: All
Tree damaging activity	None	None	None	Regulated Tree: All
All other Code Assessed Development	All	All	None	Any Relevant Overlay: All

Table 4 –Restricted Development Classification

Class of Development The following Classes of Development are classified as Restricted subject to any 'Exclusions'	Exclusions
None Specified	

Assessment Provisions

Desired Outcome (DO)

DO 1

The protection, provision, maintenance and expansion of infrastructure services and facilities that support orderly development and vehicular movements.

DO 2

Infrastructure services and facilities that manage environmental impacts.

Performance Outcomes and Deemed to Satisfy / Designated Performance Outcome Criteria

Land Use and Intensity

PO 1.1

Utility and infrastructure facilities and other services that support the orderly development of land and assist in manage impacts on the environment and community.

DTS/DPF 1.1

Development comprises one or more of the following land uses:

- Electricity substation
- Landfill, including gas extraction plant and equipment
- Water treatment and supply
- Stormwater retention / detention basin
- Sewerage treatment facility
- Public service depot
- Waste transfer depot.

PO 1.2

Development does not hinder the ongoing operation of existing utility and other infrastructure services or jeopardise the expansion of those services to support economic activity and manage impacts on the environment and community.

DTS/DPF 1.2

None are applicable.

PO 1.3

Development ancillary to utility and other infrastructure services including offices, workshops and the like are undertaken to enhance on-going operations and maintenance aspects of those services.

DTS/DPF 1.3

None are applicable.

PO 1.4

Security fencing is located behind landscaping to enhance the appearance of development from adjacent areas, roads and thoroughfares.

DTS/DPF 1.4

None are applicable.

Fencing

PO 2.1

Fencing exceeding 2.1m in height integrated and designed to complement the appearance of land and buildings and does not form a dominant visual feature from adjacent areas, roads and thoroughfares.

DTS/DPF /DPF 2.1

Fencing exceeding 2.1m in height:

- (b) located behind a façade of an associated building located on the same site; or
- (c) located behind a landscaped area along relevant street frontages; or

(d) consists of visually permeable materials with landscaping behind.

Procedural Matters (PM)

Notification

All classes of performance assessed development are excluded from notification except where they involve any of the following:

- (a) the site of the development is adjacent land to land in a different zone
- (b) development identified as "all other code assessed development" in Infrastructure Zone Table 3.

Placement of Notices – Exemptions for Performance Assessed Development

None specified.

Placement of Notices – Exemptions for Restricted Development

None specified.

Infrastructure (Airfield) Zone

Table 1 – Accepted Development Classification

Class of Development The following Classes of Development are classified as Accepted Development subject to meeting the 'Accepted Development Classification Criteria'	Accepted Development Classification Criteria
<p>Carport Except where any of the following apply: Except where any of the following apply:</p> <ul style="list-style-type: none"> • Coastal Areas Overlay • Hazards (Flooding) Overlay • State Heritage Place Overlay • Native Vegetation Overlay • State Significant Native Vegetation Overlay • Sloping Land Overlay • Key Outback and Rural Routes Overlay where an existing access is altered or a new access is created • Major Urban Transport Routes Overlay where an existing access is altered or a new access is created • Urban Transport Routes Overlay where an existing access is altered or a new access is created • Water Resources Overlay 	<ol style="list-style-type: none"> 1 The development will not be built, or encroach, on an area that is, or will be, required for a sewerage system or waste control system 2 It is ancillary to a dwelling erected on the site 3 Primary street setback – at least 5.5m from the primary street boundary and as far back as the building line of the building to which it is ancillary 4 Secondary street setback – at least 900mm from the boundary of the allotment (if the land has boundaries on two or more roads) 5 Total floor area - does not exceed 40m² 6 Post height - does not exceed 3m measured from natural ground level (and not including a gable end) 7 Building height - does not exceed 5m 8 If situated on or abutting a boundary (not being a boundary with a primary street or secondary street) – a length not exceeding 10m unless: <ol style="list-style-type: none"> (a) a longer wall or structure exists on the adjacent site and is situated on the same allotment boundary; and (b) the proposed wall or structure will be built along the same length of boundary as the existing adjacent wall or structure to the same or lesser extent 9 If the carport abuts or is situated on the boundary of the allotment (not being a boundary with a primary street or secondary street): <ol style="list-style-type: none"> (a) it will not result in all relevant walls or structures located along the boundary exceeding 45% of the length of the boundary; and (b) it will not be located within 3m of any other wall along the same boundary unless on an adjacent site on that boundary there is an existing wall of a building that would be adjacent to or abut the proposed wall or structure 10 The total roofed area of all existing or proposed buildings on the allotment does not exceed 60% of the area of the allotment 11 Door opening for vehicle access – does not exceed, in total, 7m in width or 50% of the width of the allotment frontage (whichever lesser)

	<p>12 Internal dimensions – does not exceed 3.2m in width and 6m in length between all fences, walls and doors</p> <p>13 The carport:</p> <p>(a) is located so that vehicle access:</p> <ol style="list-style-type: none"> i. is provided via a lawfully existing or authorised driveway or access point or an access point for which consent has been granted as part of an application for the division of land; or ii. will use a driveway that: <ol style="list-style-type: none"> A. is not located within 6 metres of an intersection of 2 or more roads or a pedestrian actuated crossing; and B. will not interfere with an item of street furniture (including directional signs, lighting, seating and weather shelters), other infrastructure, or a tree; or iii. if adjacent a kerbed road, will be via a kerb that is designed to allow a vehicle to roll over it; and <p>(b) is located so that the gradient from the place of access on the boundary of the allotment to the finished floor level at the front of the carport when the work is completed is not steeper than 1:4 on average; and</p> <p>(c) The centre of the driveway at the public road boundary is no more than 25 degree deviation from the centre of the front of the covered car parking space for which it provides vehicle access</p>
<p>Internal building work Except where any of the following apply:</p> <ul style="list-style-type: none"> • A State Heritage Place identified in the State Heritage Place Overlay 	<ol style="list-style-type: none"> 1 There will be no increase in the total floor area of the building 2 There will be no alteration to the external appearance of the building.
<p>Outbuilding (in the form of a garage) Except where any of the following apply:</p> <ul style="list-style-type: none"> • Coastal Areas Overlay • Hazards (Flooding) Overlay • State Heritage Place Overlay • Native Vegetation Overlay • State Significant Native Vegetation Overlay • Sloping Land Overlay • Key Outback and Rural Routes Overlay where an existing access 	<ol style="list-style-type: none"> 1 The development will not be built, or encroach, on an area that is, or will be, required for a sewerage system or waste control system 2 It is detached from and ancillary to a dwelling erected on the site. 3 Primary street setback – at least 5.5m from the primary street boundary and as far back as the building line of the building to which it is ancillary 4 Secondary street setback – at least 900mm from the boundary of the allotment (if the land has boundaries on two or more roads) 5 Total floor area - does not exceed 40m² 6 Wall height - does not exceed 3m measured from natural ground level (and not including a gable end) 7 Building height - does not exceed 5m 8 If situated on or abutting a boundary (not being a boundary with a primary street or secondary street) – a length not exceeding 10m unless:

<p>is altered or a new access is created</p> <ul style="list-style-type: none"> • Major Urban Transport Routes Overlay where an existing access is altered or a new access is created • Urban Transport Routes Overlay where an existing access is altered or a new access is created • Water Resources Overlay 	<ul style="list-style-type: none"> (a) a longer wall or structure exists on the adjacent site and is situated on the same allotment boundary; and (b) the proposed wall or structure will be built along the same length of boundary as the existing adjacent wall or structure to the same or lesser extent <p>9 If the outbuilding abuts or is situated on the boundary of the allotment (not being a boundary with a primary street or secondary street):</p> <ul style="list-style-type: none"> (a) it will not result in all relevant walls or structures located along the boundary exceeding 45% of the length of the boundary; and (b) it will not be located within 3m of any other wall along the same boundary unless on an adjacent site on that boundary there is an existing wall of a building that would be adjacent to or abut the proposed wall or structure <p>10 Total roofed area of all existing and proposed buildings on the allotment - does not exceed 60%</p> <p>11 Internal dimensions – exceed 3.2m in width and 6m in length between all walls and doors</p> <p>12 Door opening for vehicle access – does not exceed, in total, 7m in width or 50% of the width of the allotment frontage (whichever lesser)</p> <p>13 The garage:</p> <ul style="list-style-type: none"> (a) is located so that vehicle access: <ul style="list-style-type: none"> i. is provided via a lawfully existing or authorised driveway or access point or an access point for which consent has been granted as part of an application for the division of land; or ii. will use a driveway that: <ul style="list-style-type: none"> A. is not located within 6 metres of an intersection of 2 or more roads or a pedestrian actuated crossing; and B. will not interfere with an item of street furniture (including directional signs, lighting, seating and weather shelters), other infrastructure, or a tree; or iii. if adjacent a kerbed road, will be via a kerb that is designed to allow a vehicle to roll over it; and (b) is located so that the gradient from the place of access on the boundary of the allotment to the finished floor level at the front of the carport when the work is completed is not steeper than 1:4 on average; and (c) The centre of the driveway at the public road boundary is no more than 25 degree deviation from the centre of the front of the covered car parking space for which it provides vehicle access <p>14 If clad in sheet metal—is pre-colour treated or painted in a non-reflective colour.</p>
<p>Outbuilding (not being a garage) Except where any of the following apply:</p> <ul style="list-style-type: none"> • Hazards (Flooding) Overlay 	<ul style="list-style-type: none"> 1 The development will not be built, or encroach, on an area that is, or will be, required for a sewerage system or waste control system 2 It is detached from and ancillary to a dwelling erected on the site

<ul style="list-style-type: none"> • State Heritage Place Overlay • Native Vegetation Overlay • State Significant Native Vegetation Overlay • Sloping Land Overlay • Water Resources Overlay 	<ol style="list-style-type: none"> 3 Primary street setback – at least as far back as the building line of the building to which it is ancillary 4 Secondary street setback – at least 900mm from the boundary of the allotment (if the land has boundaries on two or more roads) 5 Side boundary setbacks – at least 900mm from the boundary of the allotment 6 Total floor area does not exceed 40m² 7 Wall height - does not exceed 3m measured from natural ground level (and not including a gable end) 8 Building height - does not exceed 5m 9 If situated on or abutting a boundary (not being a boundary with a primary street or secondary street) – a length not exceeding 10m unless: <ol style="list-style-type: none"> (a) a longer wall or structure exists on the adjacent site and is situated on the same allotment boundary; and (b) the proposed wall or structure will be built along the same length of boundary as the existing adjacent wall or structure to the same or lesser extent 10 If the outbuilding abuts or is situated on the boundary of the allotment (not being a boundary with a primary street or secondary street): <ol style="list-style-type: none"> (a) it will not result in all relevant walls or structures located along the boundary exceeding 45% of the length of the boundary; and (b) will not be located within 3m of any other wall along the same boundary unless on an adjacent site on that boundary there is an existing wall of a building that would be adjacent to or abut the proposed wall or structure 11 Total roofed area of all existing and proposed buildings on the allotment - does not exceed 60% 12 If clad in sheet metal—is pre-colour treated or painted in a non-reflective colour.
<p>Private bushfire shelters Except where any of the following apply:</p> <ul style="list-style-type: none"> • Coastal Areas Overlay • Hazards (Flooding) Overlay • State Heritage Place Overlay • Native Vegetation Overlay • State Significant Native Vegetation Overlay • Sloping Land Overlay • Water Resources Overlay 	<ol style="list-style-type: none"> 1 The development will not be built, or encroach, on an area that is, or will be, required for a sewerage system or waste control system 2 Primary street setback – at least as far back as the building to which it is ancillary 3 Secondary street setback – at least 900mm from the boundary of the allotment 4 At least 6m from the corner of an allotment which abuts the intersection of two or more roads (other than where a 4m x 4m allotment cut-off is already in place).
<p>Shade sail Except where any of the following apply:</p>	<ol style="list-style-type: none"> 1 The development will not be built, or encroach, on an area that is, or will be, required for a sewerage system or waste control system 2 Shade sail consists of permeable material

<ul style="list-style-type: none"> • Coastal Areas Overlay • State Heritage Place Overlay • Native Vegetation Overlay • State Significant Native Vegetation Overlay • Sloping Land Overlay • Water Resources Overlay 	<ol style="list-style-type: none"> 3 The total area of the sail - does not exceed 40m² 4 No part of the shade sail will be: <ol style="list-style-type: none"> (a) 3m above ground or floor level (depending on where it is situated) at any place within 900mm of a boundary of the allotment (b) 5m above ground or floor level (depending on where it is situated) within any other part of the allotment 5 Primary street setback – at least as far back as the building line of the building to which it is ancillary 6 If any part of the sail will be situated on a boundary of the allotment, the length of sail along a boundary does not exceed 8m 7 In a case where any part of the sail or a supporting structure will be situated on a side boundary of the allotment — the length of the sail and any such supporting structure together with all relevant walls or structures located along the boundary will not exceed 45% of the length of the boundary.
<p>Solar photovoltaic panels (roof mounted) Except where any of the following apply:</p> <ul style="list-style-type: none"> • A State Heritage Place identified in the State Heritage Place Overlay 	<ol style="list-style-type: none"> 1 Panels are installed parallel to the roof of a building and with the underside surface of the panel not being more than 100mm above the surface of the roof 2 Panels and associated components do not overhang any part of the roof 3 Does not apply to system with a generating capacity of more than 5MW that is to be connected to the State's power system.
<p>Spa pool Swimming pool Except where any of the following apply:</p> <ul style="list-style-type: none"> • Coastal Areas Overlay • Hazards (Flooding) Overlay • State Heritage Place Overlay • Native Vegetation Overlay • State Significant Native Vegetation Overlay • Sloping Land Overlay • Water Resources Overlay 	<ol style="list-style-type: none"> 1 The development will not be built, or encroach, on an area that is, or will be, required for a sewerage system or waste control system 2 It is ancillary to a dwelling erected on the site 3 Allotment boundary setback – not less than 1m 4 Primary street setback – at least as far back as the building line of the building to which it is ancillary 5 Location of filtration system from a dwelling on an adjoining allotment: <ol style="list-style-type: none"> (a) not less than 5m where the filtration system is located inside a solid structure that will have material impact on the transmission of noise (b) not less than 12m in any other case.
<p>Verandah Except where any of the following apply:</p> <ul style="list-style-type: none"> • Coastal Areas Overlay • Hazards (Flooding) Overlay • State Heritage Place Overlay • Native Vegetation Overlay 	<ol style="list-style-type: none"> 1 The development will not be built, or encroach, on an area that is, or will be, required for a sewerage system or waste control system 2 It is ancillary to a dwelling erected on the site 3 Primary street setback – as far back as the building line of the building to which it is ancillary 4 Total floor area - does not exceed 40m² 5 Post height - does not exceed 3m measured from natural ground level

<ul style="list-style-type: none"> • State Significant Native Vegetation Overlay • Water Resources Overlay 	<ol style="list-style-type: none"> 6 Building height - does not exceed 5m 7 Length - does not exceed 10m if any part of the structure abuts or is situated on a boundary of the allotment 8 Total roofed area of all existing and proposed buildings on the allotment - does not exceed 60%.
<p>Water tank (above ground) Except where any of the following apply:</p> <ul style="list-style-type: none"> • Coastal Areas Overlay • Hazards (Flooding) Overlay • State Heritage Place Overlay • Native Vegetation Overlay • State Significant Native Vegetation Overlay • Sloping Land Overlay • Water Resources Overlay 	<ol style="list-style-type: none"> 1 The development will not be built, or encroach, on an area that is, or will be, required for a sewerage system or waste control system 2 The tank is part of a roof drainage system 3 Total floor area - not exceeding 15m² 4 The tank is located wholly above ground 5 Tank height – does not exceed 4m above natural ground level 6 Primary street setback – at least as far back as the building line of the building to which it is ancillary 7 In the case of a tank made of metal – the tank is pre-colour treated or painted in a non-reflective colour.
<p>Water tank (underground) Except where any of the following apply:</p> <ul style="list-style-type: none"> • Coastal Areas Overlay • Native Vegetation Overlay • State Significant Native Vegetation Overlay • Sloping Land Overlay • Water Resources Overlay 	<ol style="list-style-type: none"> 1 The development will not be built, or encroach, on an area that is, or will be, required for a sewerage system or waste control system 2 The tank (including any associated pump) is located wholly below the level of the ground.

Table 2 - Deemed-to-Satisfy Development Classification

Class of Development The following Classes of Development are classified as Deemed-to-Satisfy Development subject to meeting the 'Deemed-to-Satisfy Development Classification Criteria'	Deemed-to-Satisfy Development Classification Criteria Provisions referred to are Deemed-to-Satisfy Criteria Where a development comprises more than one Class of Development the relevant criteria will be taken to be the sum of the criteria for each Class of Development.			
	Zone	General Development Policies	Subzone (applies only in the area affected by the Subzone)	Overlay (applies only in the area affected by the Overlay)
Advertisement Except where any of the following apply: <ul style="list-style-type: none"> • Coastal Areas Overlay • Hazards (Flooding) Overlay • Sloping Land Overlay • State Heritage Place Overlay • Water Protection Area Overlay • Water Resource Overlay 	[Advertisements]: DTS 5.1	Advertisements [Appearance]: DTS 1.1, 1.3, 1.4 Advertisements [Proliferation of Advertisements]: DTS 2.1, 2.2 Advertisements [Advertising Content]: DTS 3.1 Advertisements [Amenity Content]: DTS 4.1 Advertising [Safety]: DTS 5.1, 5.2, 5.3, 5.4, 5.5 Clearance from Overhead Powerlines: DTS 1.1	None	Airport Building Heights (Aircraft Landing Area): DTS 1.1 Airport Building Heights (Regulated): DTS 1.1, 1.2 Building Near Airfields: DTS 1.1, 1.2 Hazards (Acid Sulfate Soils): DTS 1.1 Key Outback and Rural Routes: DTS 8.1, 10.1 Major Transport Routes: DTS 8.1, 10.1 Native Vegetation: DTS 1.1, 1.2 State Significant Native Vegetation: DTS 1.1

Class of Development The following Classes of Development are classified as Deemed-to-Satisfy Development subject to meeting the 'Deemed-to-Satisfy Development Classification Criteria'	Deemed-to-Satisfy Development Classification Criteria Provisions referred to are Deemed-to-Satisfy Criteria Where a development comprises more than one Class of Development the relevant criteria will be taken to be the sum of the criteria for each Class of Development.			
	Zone	General Development Policies	Subzone (applies only in the area affected by the Subzone)	Overlay (applies only in the area affected by the Overlay)
				Urban Transport Routes: DTS 8.1, 10.1
Carport Outbuilding in the form of a garage Except where any of the following apply: <ul style="list-style-type: none"> Coastal Areas Overlay Hazards (Bushfire - General Risk) Overlay Hazards (Bushfire - High Risk) Overlay Hazards (Bushfire - Medium Risk) Overlay Hazards (Bushfire - Outback) Overlay 	None	Clearance from Overhead Powerlines: DTS 1.1 Design in Urban Areas [All Residential Development – Ancillary Development]: DTS 17.1, 17.2 Design in Urban Areas [Residential Development – 3 Building Levels or Less – External Appearance]: DTS 19.1 Design in Urban Areas [Residential Development – 3 Building Levels or Less – Car parking, Access and Manoeuvrability]: All	None	Airport Building Heights (Aircraft Landing Area): DTS 1.1 Airport Building Heights (Regulated): DTS 1.1, 1.2 Building Near Airfields: DTS 1.1, 1.2 Hazards (Acid Sulfate Soils): DTS 1.1 Key Outback and Rural Routes: DTS All Major Transport Routes: DTS All

Class of Development The following Classes of Development are classified as Deemed-to-Satisfy Development subject to meeting the 'Deemed-to-Satisfy Development Classification Criteria'	Deemed-to-Satisfy Development Classification Criteria Provisions referred to are Deemed-to-Satisfy Criteria Where a development comprises more than one Class of Development the relevant criteria will be taken to be the sum of the criteria for each Class of Development.			
	Zone	General Development Policies	Subzone (applies only in the area affected by the Subzone)	Overlay (applies only in the area affected by the Overlay)
<ul style="list-style-type: none"> • Hazards (Bushfire - Regional) Overlay • Hazards (Flooding) Overlay • Sloping Land Overlay • State Heritage Place Overlay • State Significant Native Vegetation Overlay • Water Protection Area Overlay • Water Resources Overlay 		Transport, Access and Parking [Vehicle Access]: DTS 3.1, 3.5, 3.6		Native Vegetation: DTS 1.1, 1.2 State Significant Native Vegetation: DTS 1.1 Urban Transport Routes: DTS All
Outbuilding Except where any of the following apply: <ul style="list-style-type: none"> • Coastal Areas Overlay • Hazards (Bushfire - General Risk) Overlay 	None	Clearance from Overhead Powerlines: DTS 1.1 Design in Urban Areas [All Residential Development – Ancillary Development]: DTS 17.1, 17.2	None	Airport Building Heights (Aircraft Landing Area): DTS 1.1 Airport Building Heights (Regulated): DTS 1.1, 1.2

Class of Development

The following Classes of Development are classified as Deemed-to-Satisfy Development subject to meeting the 'Deemed-to-Satisfy Development Classification Criteria'

Deemed-to-Satisfy Development Classification Criteria

Provisions referred to are Deemed-to-Satisfy Criteria
Where a development comprises more than one Class of Development the relevant criteria will be taken to be the sum of the criteria for each Class of Development.

Zone	General Development Policies	Subzone (applies only in the area affected by the Subzone)	Overlay (applies only in the area affected by the Overlay)
-------------	-------------------------------------	--	--

- Hazards (Bushfire - High Risk) Overlay
- Hazards (Bushfire - Medium Risk) Overlay
- Hazards (Bushfire - Outback) Overlay
- Hazards (Bushfire - Regional) Overlay
- Hazards (Flooding) Overlay
- Sloping Land Overlay
- State Heritage Place Overlay
- State Significant Native Vegetation Overlay
- Water Protection Area Overlay
- Water Resources Overlay

Building Near Airfields: DTS 1.1, 1.2
Hazards (Acid Sulfate Soils): DTS 1.1
Native Vegetation: DTS 1.1, 1.2
State Significant Native Vegetation: DTS 1.1

Table 3 – Applicable Policies for Performance Assessed Development

Class of Development	Applicable Policies			
	Zone	General Development Policies	Subzone (applies only in the area affected by the Subzone)	Overlay (applies only in the area affected by the Overlay)
Advertisement	[Advertisements]: DTS 5.1	Advertisements [Appearance]: PO 1.1, 1.3, 1.4 Advertisements [Proliferation of Advertisements]: PO 2.1, 2.2 Advertisements [Advertising Content]: PO 3.1 Advertisements [Amenity Content]: PO 4.1 Advertising [Safety]: PO 5.1, 5.2, 5.3, 5.4, 5.5 Clearance from Overhead Powerlines: PO 1.1	None	Airport Building Heights (Aircraft Landing Area): PO 1.1 Airport Building Heights (Regulated): PO 1.1, 1.2 Building Near Airfields: PO 1.1, 1.2 Coastal Areas: All Hazards (Acid Sulfate Soils): PO 1.1 Hazards (Flooding): All Key Outback and Rural Routes: PO 8.1, 10.1 Major Transport Routes: PO 8.1, 10.1 Native Vegetation: PO 1.1, 1.2 Sloping Land: All

Class of Development	Applicable Policies			
	Zone	General Development Policies	Subzone (applies only in the area affected by the Subzone)	Overlay (applies only in the area affected by the Overlay)
				<p>State Heritage Place: All</p> <p>State Significant Native Vegetation: PO 1.1</p> <p>Urban Transport Routes: PO 8.1, 10.1</p> <p>Water Protection Area: All</p> <p>Water Resource: All</p>
Carport	<p>[Land Use]: PO 1.2</p> <p>[Hazard Management]: PO 4.1</p>	<p>Clearance from Overhead Powerlines: PO 1.1</p> <p>Design in Urban Areas [All Residential Development – Ancillary Development]: PO 17.1, 17.2</p> <p>Design in Urban Areas [Residential Development – 3 Building Levels or</p>	<p>Residential Aviation Estate Subzone:</p>	<p>Airport Building Heights (Aircraft Landing Area): PO 1.1</p> <p>Airport Building Heights (Regulated): PO 1.1, 1.2</p> <p>Building Near Airfields: PO 1.1, 1.2</p> <p>Coastal Areas: All</p> <p>Hazards (Acid Sulfate Soils): PO 1.1</p>

Class of Development	Applicable Policies The following policies are applicable to the assessment of the identified Class of Development. Policies referred to are Performance Outcome policies, and any associated Designated Performance Features. Relevant Desired Outcomes are not listed, but automatically apply in relation to a Performance Assessed Development. Where a development comprises more than one Class of Development the relevant policies will be taken to be the sum of the applicable policies for each Class of Development.			
	Zone	General Development Policies	Subzone (applies only in the area affected by the Subzone)	Overlay (applies only in the area affected by the Overlay)
		Less – External Appearance]: PO 19.1 Design in Urban Areas [Residential Development – 3 Building Levels or Less – Car parking, Access and Manoeuvrability]: All Transport, Access and Parking [Vehicle Access]: PO 3.1, 3.5, 3.6		Hazards (Bushfire - General Risk): All Hazards (Bushfire - High Risk): All Hazards (Bushfire - Medium Risk): All Hazards (Bushfire - Outback): All Hazards (Bushfire - Regional): All Hazards (Flooding): All Key Outback and Rural Routes: All Major Transport Routes: PO All Murray Darling Basin: All Native Vegetation: PO 1.1, 1.2 Sloping Land: All State Heritage Place: All

Class of Development	Applicable Policies			
	Zone	General Development Policies	Subzone (applies only in the area affected by the Subzone)	Overlay (applies only in the area affected by the Overlay)
				State Significant Native Vegetation: All Urban Transport Routes: PO All Water Protection Area: All Water Resources: All
Demolition of a State or Local Heritage Place	None	None	None	State Heritage Place: All
Dwelling Addition	[Land Use]: PO 1.2 [Hazard Management]: PO 4.1	Clearance from Overhead Powerlines: PO 1.1 Design in Urban Areas [All Residential Development – External Appearance]: PO 14.1	Residential Aviation Estate Subzone [Land Use and Intensity]: PO 1.3 Residential Aviation Estate	Aircraft Noise Exposure: All Airport Building Heights (Aircraft Landing Area): PO 1.1 Airport Building Heights (Regulated): PO 1.1, 1.2

Class of Development

Applicable Policies

The following policies are applicable to the assessment of the identified Class of Development. Policies referred to are Performance Outcome policies, and any associated Designated Performance Features. Relevant Desired Outcomes are not listed, but automatically apply in relation to a Performance Assessed Development.
 Where a development comprises more than one Class of Development the relevant policies will be taken to be the sum of the applicable policies for each Class of Development.

Zone	General Development Policies	Subzone (applies only in the area affected by the Subzone)	Overlay (applies only in the area affected by the Overlay)
-------------	-------------------------------------	--	--

		Design in Urban Areas [All Residential Development – Outlook and Amenity]: PO 15.1 Design in Urban Areas [All Residential Development – 3 Building Levels or Less – External Appearance]: PO 19.1, 19.2, 19.3 Design in Urban Areas [All Residential Development – 3 Building Levels or Less – Overlooking / Visual Privacy]: PO 20.1 Design in Urban Areas [All Residential Development – 3 Building Levels or Less –Private Open Space]: PO 21.1, 21.2, 21.3	Subzone [Building Height]: PO 3.1 Residential Aviation Estate Subzone [Primary Street Setback]: PO 4.1 Residential Aviation Estate Subzone [Secondary Street Setback]: PO 5.1	Building Near Airfields: PO 1.1, 1.2 Coastal Areas: All Hazards (Acid Sulfate Soils): PO 1.1 Hazards (Bushfire - General Risk): All Hazards (Bushfire - High Risk): All Hazards (Bushfire - Medium Risk): All Hazards (Bushfire - Outback): All Hazards (Bushfire - Regional): All Hazards (Flooding): All Murray Darling Basin: All Native Vegetation: PO 1.1, 1.2 Sloping Land: All
--	--	---	---	--

Class of Development

Applicable Policies

The following policies are applicable to the assessment of the identified Class of Development. Policies referred to are Performance Outcome policies, and any associated Designated Performance Features. Relevant Desired Outcomes are not listed, but automatically apply in relation to a Performance Assessed Development.
 Where a development comprises more than one Class of Development the relevant policies will be taken to be the sum of the applicable policies for each Class of Development.

Zone	General Development Policies	Subzone (applies only in the area affected by the Subzone)	Overlay (applies only in the area affected by the Overlay)
-------------	-------------------------------------	--	--

		Design in Urban Areas [All Residential Development – 3 Building Levels or Less – Landscaping]: PO 22.1, 22.2 Design in Urban Areas [All Residential Development – 3 Building Levels or Less – Waste Storage]: PO 25.1 Infrastructure and Renewable Energy Facilities [Water Supply]: PO 11.2 Infrastructure and Renewable Energy Facilities [Wastewater Services]: PO 12.1, 12.2 Interface Between Land Uses [Overshadowing]: PO 3.1, 3.2	Residential Aviation Estate Subzone [Side Boundary Setback]: PO 6.1 Residential Aviation Estate Subzone [Rear Boundary Setback]: PO 7.1	State Heritage Place: All State Significant Native Vegetation: All Water Protection Area: All Water Resources: All
--	--	---	--	---

Class of Development	Applicable Policies			
	Zone	General Development Policies	Subzone (applies only in the area affected by the Subzone)	Overlay (applies only in the area affected by the Overlay)
		<p>Interface Between Land Uses [Activities Generating Noise or Vibration]: PO 4.4</p> <p>Site Contamination: PO 1.1</p>		
<p>Detached Dwelling Where any of the following apply:</p> <ul style="list-style-type: none"> Residential Aviation Estate Subzone 	<p>[Land Use]: PO 1.2</p> <p>[Hazard Management]: PO 4.1</p>	<p>Clearance from Overhead Powerlines: PO 1.1</p> <p>Design in Urban Areas [All Development – Car Parking Appearance]: PO 6.1</p> <p>Design in Urban Areas [All Residential Development – External Appearance]: PO 14.1, 14.2</p> <p>Design in Urban Areas [All Residential Development – Outlook and Amenity]: PO 15.1</p>	<p>Residential Aviation Estate Subzone [Land Use and Intensity]: PO 1.1, 1.3</p> <p>Residential Aviation Estate Subzone [Building Height]: PO 3.1</p> <p>Residential Aviation Estate</p>	<p>Aircraft Noise Exposure: All</p> <p>Airport Building Heights (Aircraft Landing Area): PO 1.1</p> <p>Airport Building Heights (Regulated): PO 1.1, 1.2</p> <p>Building Near Airfields: PO 1.1, 1.2</p> <p>Coastal Areas: All</p> <p>Hazards (Acid Sulfate Soils): PO 1.1</p> <p>Hazards (Bushfire - General Risk): All</p> <p>Hazards (Bushfire - High Risk): All</p>

Class of Development

Applicable Policies

The following policies are applicable to the assessment of the identified Class of Development. Policies referred to are Performance Outcome policies, and any associated Designated Performance Features. Relevant Desired Outcomes are not listed, but automatically apply in relation to a Performance Assessed Development.
 Where a development comprises more than one Class of Development the relevant policies will be taken to be the sum of the applicable policies for each Class of Development.

Zone	General Development Policies	Subzone (applies only in the area affected by the Subzone)	Overlay (applies only in the area affected by the Overlay)
-------------	-------------------------------------	--	--

		Design in Urban Areas [All Residential Development – Access and Servicing]: PO 16.1 Design in Urban Areas [All Residential Development – Flooding]: PO 18.1 Design in Urban Areas [All Residential Development – 3 Building Levels or Less – External Appearance]: PO 19.1, 19.2, 19.3 Design in Urban Areas [All Residential Development – 3 Building Levels or Less – Overlooking / Visual Privacy]: PO 20.1 Design in Urban Areas [All Residential Development – 3	Subzone [Primary Street Setback]: PO 4.1 Residential Aviation Estate Subzone [Secondary Street Setback]: PO 5.1 Residential Aviation Estate Subzone [Side Boundary Setback]: PO 6.1	Hazards (Bushfire - Medium Risk): All Hazards (Bushfire - Outback): All Hazards (Bushfire - Regional): All Hazards (Flooding): All Key Outback and Rural Routes: All Major Transport Routes: PO All Murray Darling Basin: All Native Vegetation: PO 1.1, 1.2 Prescribed Water Resources Area: All Prescribed Wells Area: All Sloping Land: All State Heritage Place: All
--	--	---	---	---

Class of Development	Applicable Policies			
	Zone	General Development Policies	Subzone (applies only in the area affected by the Subzone)	Overlay (applies only in the area affected by the Overlay)
		<p>Building Levels or Less –Private Open Space]: PO 21.1, 21.2, 21.3</p> <p>Design in Urban Areas [All Residential Development – 3 Building Levels or Less – Landscaping]: PO 22.1, 22.2</p> <p>Design in Urban Areas [All Residential Development – 3 Building Levels or Less – Water Sensitive Design]: PO 23.1, 23.2, 23.3</p> <p>Design in Urban Areas [All Residential Development – 3 Building Levels or Less – Car Parking and Manoeuvrability]: PO 24.1, 24.2, 24.3, 24.4, 24.5, 24.6</p>	<p>Residential Aviation Estate Subzone [Rear Boundary Setback]: PO 7.1</p>	<p>State Significant Native Vegetation: All</p> <p>Urban Transport Routes: PO All</p> <p>Water Protection Area: All</p> <p>Water Resources: All</p>

Class of Development	Applicable Policies The following policies are applicable to the assessment of the identified Class of Development. Policies referred to are Performance Outcome policies, and any associated Designated Performance Features. Relevant Desired Outcomes are not listed, but automatically apply in relation to a Performance Assessed Development. Where a development comprises more than one Class of Development the relevant policies will be taken to be the sum of the applicable policies for each Class of Development.			
	Zone	General Development Policies	Subzone (applies only in the area affected by the Subzone)	Overlay (applies only in the area affected by the Overlay)
		Design in Urban Areas [All Residential Development – 3 Building Levels or Less – Waste Storage]: PO 25.1 Infrastructure and Renewable Energy Facilities [Water Supply]: PO 11.2 Infrastructure and Renewable Energy Facilities [Wastewater Services]: PO 12.1, 12.2 Interface Between Land Uses [Overshadowing]: PO 3.1, 3.2 Interface Between Land Uses [Interface Between Rural Activities]: PO 9.3, 9.4, 9.5		

Class of Development	Applicable Policies			
	Zone	General Development Policies	Subzone (applies only in the area affected by the Subzone)	Overlay (applies only in the area affected by the Overlay)
		<p>Interface Between Land Uses [Interface with Mines and Quarries (Rural and Remote Areas)]: PO 10.1</p> <p>Transport, Access and Parking [Vehicle Access]: PO 3.1, 3.5, 3.6</p> <p>Transport, Access and Parking [Vehicle Parking Rates]: PO 5.1</p> <p>Site Contamination: PO 1.1</p>		
<p>Light industry</p> <p>Except where any of the following apply:</p> <ul style="list-style-type: none"> Residential Aviation Estate Subzone 	<p>[Land Use]: PO 1.2</p> <p>[Built Form and Character]: PO 2.1</p>	<p>Clearance from Overhead Powerlines: PO 1.1</p> <p>Design in Rural Areas [On-site Waste Treatment Systems]: PO 6.1</p> <p>Design in Urban Areas [All development – External appearance]: PO 1.4, 1.5</p>	None	<p>Airport Building Heights (Aircraft Landing Area): PO 1.1</p> <p>Airport Building Heights (Regulated): PO 1.1, 1.2</p> <p>Building Near Airfields: PO 1.1, 1.2</p> <p>Coastal Areas: All</p>

Class of Development	Applicable Policies			
	Zone	General Development Policies	Subzone (applies only in the area affected by the Subzone)	Overlay (applies only in the area affected by the Overlay)
	[Hazard Management]: PO 4.1, 4.2	<p>Design in Urban Areas [All development – Water Sensitive Urban Design]: PO 5.1</p> <p>Design in Urban Areas [Car Parking Appearance]: PO 6.2</p> <p>Design in Urban Areas [All Non-Residential Development – Water Sensitive Design]: PO 42.1</p> <p>Infrastructure and Renewable Energy Facilities [Water Supply]: PO 11.1</p> <p>Infrastructure and Renewable Energy Facilities [Wastewater Services]: PO 12.1, 12.2</p>		<p>Hazards (Acid Sulfate Soils): PO 1.1</p> <p>Hazards (Bushfire - General Risk): All</p> <p>Hazards (Bushfire - High Risk): All</p> <p>Hazards (Bushfire - Medium Risk): All</p> <p>Hazards (Bushfire - Outback): All</p> <p>Hazards (Bushfire - Regional): All</p> <p>Hazards (Flooding): All</p> <p>Key Outback and Rural Routes: All</p> <p>Major Transport Routes: PO All</p> <p>Murray Darling Basin: All</p> <p>Native Vegetation: PO 1.1, 1.2</p> <p>Prescribed Water Resources Area: All</p>

Class of Development	Applicable Policies			
	Zone	General Development Policies	Subzone (applies only in the area affected by the Subzone)	Overlay (applies only in the area affected by the Overlay)
		<p>Interface Between Land Uses [General Land Use Compatibility]: PO 1.2</p> <p>Interface Between Land Uses [Hours of Operation]: PO 2.1</p> <p>Interface Between Land Uses [Activities Generating Noise or Vibration]: PO 4.2</p> <p>Interface Between Land Uses [Light Spill]: PO 6.1, 6.2</p> <p>Transport, Access and Parking [Movement Systems]: PO 1.1, 1.2, 1.3, 1.4</p> <p>Transport, Access and Parking [Sightlines]: PO 2.1, 2.2</p>		<p>Prescribed Wells Area: All</p> <p>Sloping Land: All</p> <p>State Heritage Place: All</p> <p>State Significant Native Vegetation: All</p> <p>Urban Transport Routes: PO All</p> <p>Water Protection Area: All</p> <p>Water Resources: All</p>

Class of Development	Applicable Policies			
	Zone	General Development Policies	Subzone (applies only in the area affected by the Subzone)	Overlay (applies only in the area affected by the Overlay)
		<p>Transport, Access and Parking [Vehicle Access]: PO 3.1, 3.3, 3.4, 3.5, 3.7, 3.8, 3.9</p> <p>Transport, Access and Parking [Vehicle Parking Rates]: PO 5.1</p> <p>Transport, Access and Parking [Vehicle Parking Areas]: PO 6.1, 6.2, 6.5, 6.6</p>		
Outbuilding (in the form of a garage)	<p>[Land Use]: PO 1.2</p> <p>[Built Form and Character]: PO 2.1</p>	<p>Clearance from Overhead Powerlines: DTS 1.1</p> <p>Design in Urban Areas [All Residential Development – Ancillary Development]: DTS 17.1, 17.2</p>	<p>Residential Aviation Estate Subzone [Land Use and Intensity]: PO 1.2</p> <p>Residential Aviation Estate</p>	<p>Airport Building Heights (Aircraft Landing Area): PO 1.1</p> <p>Airport Building Heights (Regulated): PO 1.1, 1.2</p> <p>Building Near Airfields: PO 1.1, 1.2</p> <p>Coastal Areas: All</p>

Class of Development	Applicable Policies			
	Zone	General Development Policies	Subzone (applies only in the area affected by the Subzone)	Overlay (applies only in the area affected by the Overlay)
	[Hazard Management]: PO 4.1	<p>Design in Urban Areas [Residential Development – 3 Building Levels or Less – External Appearance]: DTS 19.1</p> <p>Design in Urban Areas [Residential Development – 3 Building Levels or Less – Car parking, Access and Manoeuvrability]: All</p> <p>Transport, Access and Parking [Vehicle Access]: DTS 3.1, 3.5, 3.6</p>	<p>Subzone [Building Height]: PO 3.1</p> <p>Residential Aviation Estate Subzone [Primary Street Setback]: PO 4.1</p> <p>Residential Aviation Estate Subzone [Secondary Street Setback]: PO 5.1</p>	<p>Hazards (Acid Sulfate Soils): PO 1.1</p> <p>Hazards (Bushfire - General Risk): All</p> <p>Hazards (Bushfire - High Risk): All</p> <p>Hazards (Bushfire - Medium Risk): All</p> <p>Hazards (Bushfire - Outback): All</p> <p>Hazards (Bushfire - Regional): All</p> <p>Hazards (Flooding): All</p> <p>Key Outback and Rural Routes: All</p> <p>Major Transport Routes: PO All</p> <p>Murray Darling Basin: All</p> <p>Native Vegetation: PO 1.1, 1.2</p> <p>Sloping Land: All</p>

Class of Development	Applicable Policies			
	Zone	General Development Policies	Subzone (applies only in the area affected by the Subzone)	Overlay (applies only in the area affected by the Overlay)
			Residential Aviation Estate Subzone [Side Boundary Setback]: PO 6.1 Residential Aviation Estate Subzone [Rear Boundary Setback]: PO 7.1	State Heritage Place: All State Significant Native Vegetation: All Urban Transport Routes: PO All Water Protection Area: All Water Resources: All
Outbuilding (not being a garage or a hangar)	[Land Use]: PO 1.2 [Built Form and Character]: PO 2.1	Clearance from Overhead Powerlines: PO 1.1 Design in Urban Areas [All Residential Development –	Residential Aviation Estate Subzone [Land Use and Intensity]: PO 1.2, 1.3	Airport Building Heights (Aircraft Landing Area): PO 1.1 Airport Building Heights (Regulated): PO 1.1, 1.2

Class of Development	Applicable Policies			
	Zone	General Development Policies	Subzone (applies only in the area affected by the Subzone)	Overlay (applies only in the area affected by the Overlay)
	[Hazard Management]: PO 4.1	Ancillary Development]: PO 17.1, 17.2	Residential Aviation Estate Subzone [Building Height]: PO 3.2 Residential Aviation Estate Subzone [Primary Street Setback]: PO 4.1 Residential Aviation Estate Subzone [Secondary Street	Building Near Airfields: PO 1.1, 1.2 Coastal Areas: All Hazards (Acid Sulfate Soils): PO 1.1 Hazards (Bushfire - General Risk): All Hazards (Bushfire - High Risk): All Hazards (Bushfire - Medium Risk): All Hazards (Bushfire - Outback): All Hazards (Bushfire - Regional): All Hazards (Flooding): All Murray Darling Basin: All Native Vegetation: PO 1.1, 1.2 Sloping Land: All

Class of Development	Applicable Policies			
	Zone	General Development Policies	Subzone (applies only in the area affected by the Subzone)	Overlay (applies only in the area affected by the Overlay)
			Setback]: PO 5.1 Residential Aviation Estate Subzone [Side Boundary Setback]: PO 6.1 Residential Aviation Estate Subzone [Rear Boundary Setback]: PO 7.1	State Heritage Place: All State Significant Native Vegetation: All Water Protection Area: All Water Resources: All
Shop Except where any of the following apply:	[Land Use]: PO 1.2	Clearance from Overhead Powerlines: PO 1.1	None	Airport Building Heights (Aircraft Landing Area): PO 1.1

Class of Development

Applicable Policies

The following policies are applicable to the assessment of the identified Class of Development. Policies referred to are Performance Outcome policies, and any associated Designated Performance Features. Relevant Desired Outcomes are not listed, but automatically apply in relation to a Performance Assessed Development.
 Where a development comprises more than one Class of Development the relevant policies will be taken to be the sum of the applicable policies for each Class of Development.

Zone	General Development Policies	Subzone (applies only in the area affected by the Subzone)	Overlay (applies only in the area affected by the Overlay)
-------------	-------------------------------------	--	--

<ul style="list-style-type: none"> Residential Aviation Estate Subzone 	<p>[Built Form and Character]: PO 2.1</p> <p>[Hazard Management]: PO 4.1, 4.2</p>	<p>Design in Rural Areas [On-site Waste Treatment Systems]: PO 6.1</p> <p>Design in Urban Areas [All development – External appearance]: PO 1.4, 1.5</p> <p>Design in Urban Areas [All development – Water Sensitive Urban Design]: PO 5.1</p> <p>Design in Urban Areas [Car Parking Appearance]: PO 6.2</p> <p>Design in Urban Areas [All Non-Residential Development – Water Sensitive Design]: PO 42.1</p> <p>Infrastructure and Renewable Energy Facilities [Water Supply]: PO 11.1</p>		<p>Airport Building Heights (Regulated): PO 1.1, 1.2</p> <p>Building Near Airfields: PO 1.1, 1.2</p> <p>Coastal Areas: All</p> <p>Hazards (Acid Sulfate Soils): PO 1.1</p> <p>Hazards (Bushfire - General Risk): All</p> <p>Hazards (Bushfire - High Risk): All</p> <p>Hazards (Bushfire - Medium Risk): All</p> <p>Hazards (Bushfire - Outback): All</p> <p>Hazards (Bushfire - Regional): All</p> <p>Hazards (Flooding): All</p> <p>Key Outback and Rural Routes: All</p>
---	---	---	--	---

Class of Development	Applicable Policies			
	Zone	General Development Policies	Subzone (applies only in the area affected by the Subzone)	Overlay (applies only in the area affected by the Overlay)
		<p>Infrastructure and Renewable Energy Facilities [Wastewater Services]: PO 12.1, 12.2</p> <p>Interface Between Land Uses [General Land Use Compatibility]: PO 1.2</p> <p>Interface Between Land Uses [Hours of Operation]: PO 2.1</p> <p>Interface Between Land Uses [Activities Generating Noise or Vibration]: PO 4.2</p> <p>Interface Between Land Uses [Light Spill]: PO 6.1, 6.2</p> <p>Transport, Access and Parking [Movement Systems]: PO 1.1, 1.2, 1.3, 1.4</p>		<p>Major Transport Routes: PO All</p> <p>Murray Darling Basin: All</p> <p>Native Vegetation: PO 1.1, 1.2</p> <p>Prescribed Water Resources Area: All</p> <p>Prescribed Wells Area: All</p> <p>Sloping Land: All</p> <p>State Heritage Place: All</p> <p>State Significant Native Vegetation: All</p> <p>Urban Transport Routes: PO All</p> <p>Water Protection Area: All</p> <p>Water Resources: All</p>

Class of Development	Applicable Policies			
	Zone	General Development Policies	Subzone (applies only in the area affected by the Subzone)	Overlay (applies only in the area affected by the Overlay)
		<p>Transport, Access and Parking [Sightlines]: PO 2.1, 2.2</p> <p>Transport, Access and Parking [Vehicle Access]: PO 3.1, 3.3, 3.4, 3.5, 3.7, 3.8, 3.9</p> <p>Transport, Access and Parking [Vehicle Parking Rates]: PO 5.1</p> <p>Transport, Access and Parking [Vehicle Parking Areas]: PO 6.1, 6.2, 6.5, 6.6</p>		
<p>Store Except where any of the following apply:</p> <ul style="list-style-type: none"> Residential Aviation Estate Subzone 	<p>[Land Use]: PO 1.2</p> <p>[Built Form and Character]: PO 2.1</p>	<p>Clearance from Overhead Powerlines: PO 1.1</p> <p>Design in Rural Areas [On-site Waste Treatment Systems]: PO 6.1</p>	None	<p>Airport Building Heights (Aircraft Landing Area): PO 1.1</p> <p>Airport Building Heights (Regulated): PO 1.1, 1.2</p>

Class of Development	Applicable Policies			
	Zone	General Development Policies	Subzone (applies only in the area affected by the Subzone)	Overlay (applies only in the area affected by the Overlay)
	[Hazard Management]: PO 4.1, 4.2	<p>Design in Urban Areas [All development – External appearance]: PO 1.4, 1.5</p> <p>Design in Urban Areas [All development – Water Sensitive Urban Design]: PO 5.1</p> <p>Design in Urban Areas [Car Parking Appearance]: PO 6.2</p> <p>Design in Urban Areas [All Non-Residential Development – Water Sensitive Design]: PO 42.1</p> <p>Infrastructure and Renewable Energy Facilities [Water Supply]: PO 11.1</p>		<p>Building Near Airfields: PO 1.1, 1.2</p> <p>Coastal Areas: All</p> <p>Hazards (Acid Sulfate Soils): PO 1.1</p> <p>Hazards (Bushfire - General Risk): All</p> <p>Hazards (Bushfire - High Risk): All</p> <p>Hazards (Bushfire - Medium Risk): All</p> <p>Hazards (Bushfire - Outback): All</p> <p>Hazards (Bushfire - Regional): All</p> <p>Hazards (Flooding): All</p> <p>Key Outback and Rural Routes: All</p> <p>Major Transport Routes: PO All</p> <p>Murray Darling Basin: All</p>

Class of Development	Applicable Policies			
	Zone	General Development Policies	Subzone (applies only in the area affected by the Subzone)	Overlay (applies only in the area affected by the Overlay)
		<p>Infrastructure and Renewable Energy Facilities [Wastewater Services]: PO 12.1, 12.2</p> <p>Interface Between Land Uses [General Land Use Compatibility]: PO 1.2</p> <p>Interface Between Land Uses [Hours of Operation]: PO 2.1</p> <p>Interface Between Land Uses [Activities Generating Noise or Vibration]: PO 4.2</p> <p>Interface Between Land Uses [Light Spill]: PO 6.1, 6.2</p> <p>Transport, Access and Parking [Movement Systems]: PO 1.1, 1.2, 1.3, 1.4</p>		<p>Native Vegetation: PO 1.1, 1.2</p> <p>Prescribed Water Resources Area: All</p> <p>Prescribed Wells Area: All</p> <p>Sloping Land: All</p> <p>State Heritage Place: All</p> <p>State Significant Native Vegetation: All</p> <p>Urban Transport Routes: PO All</p> <p>Water Protection Area: All</p> <p>Water Resources: All</p>

Class of Development	Applicable Policies			
	Zone	General Development Policies	Subzone (applies only in the area affected by the Subzone)	Overlay (applies only in the area affected by the Overlay)
		<p>Transport, Access and Parking [Sightlines]: PO 2.1, 2.2</p> <p>Transport, Access and Parking [Vehicle Access]: PO 3.1, 3.3, 3.4, 3.5, 3.7, 3.8, 3.9</p> <p>Transport, Access and Parking [Vehicle Parking Rates]: PO 5.1</p> <p>Transport, Access and Parking [Vehicle Parking Areas]: PO 6.1, 6.2, 6.5, 6.6</p>		
Tree damaging activity	None	None	None	Regulated Tree: All
Verandah	[Land Use]: PO 1.2	Clearance from Overhead Powerlines: PO 1.1	None	Airport Building Heights (Aircraft Landing Area): PO 1.1

Class of Development	Applicable Policies			
	Zone	General Development Policies	Subzone (applies only in the area affected by the Subzone)	Overlay (applies only in the area affected by the Overlay)
	[Hazard Management]: PO 4.1	Design in Urban Areas [All Residential Development – Ancillary Development]: PO 17.1, 17.2		Airport Building Heights (Regulated): PO 1.1, 1.2 Building Near Airfields: PO 1.1, 1.2 Coastal Areas: All Hazards (Acid Sulfate Soils): PO 1.1 Hazards (Bushfire - General Risk): All Hazards (Bushfire - High Risk): All Hazards (Bushfire - Medium Risk): All Hazards (Bushfire - Outback): All Hazards (Bushfire - Regional): All Hazards (Flooding): All Local Heritage Place: All

Class of Development	Applicable Policies			
	Zone	General Development Policies	Subzone (applies only in the area affected by the Subzone)	Overlay (applies only in the area affected by the Overlay)
				<p>Murray Darling Basin: All</p> <p>Native Vegetation: PO 1.1, 1.2</p> <p>Sloping Land: All</p> <p>State Heritage Place: All</p> <p>State Significant Native Vegetation: PO 1.1</p> <p>Water Protection Area: All</p> <p>Water Resources: All</p>
<p>Warehouse</p> <p>Except where any of the following apply:</p> <ul style="list-style-type: none"> Residential Aviation Estate Subzone 	[Land Use]: PO 1.2	<p>Clearance from Overhead Powerlines: PO 1.1</p> <p>Design in Rural Areas [On-site Waste Treatment Systems]: PO 6.1</p>	None	<p>Airport Building Heights (Aircraft Landing Area): PO 1.1</p> <p>Airport Building Heights (Regulated): PO 1.1, 1.2</p>

Class of Development	Applicable Policies			
	Zone	General Development Policies	Subzone (applies only in the area affected by the Subzone)	Overlay (applies only in the area affected by the Overlay)
	<p>[Built Form and Character]: PO 2.1</p> <p>[Hazard Management]: PO 4.1, 4.2</p>	<p>Design in Urban Areas [All development – External appearance]: PO 1.4, 1.5</p> <p>Design in Urban Areas [All development – Water Sensitive Urban Design]: PO 5.1</p> <p>Design in Urban Areas [Car Parking Appearance]: PO 6.2</p> <p>Design in Urban Areas [All Non-Residential Development – Water Sensitive Design]: PO 42.1</p> <p>Infrastructure and Renewable Energy Facilities [Water Supply]: PO 11.1</p>		<p>Building Near Airfields: PO 1.1, 1.2</p> <p>Coastal Areas: All</p> <p>Hazards (Acid Sulfate Soils): PO 1.1</p> <p>Hazards (Bushfire - General Risk): All</p> <p>Hazards (Bushfire - High Risk): All</p> <p>Hazards (Bushfire - Medium Risk): All</p> <p>Hazards (Bushfire - Outback): All</p> <p>Hazards (Bushfire - Regional): All</p> <p>Hazards (Flooding): All</p> <p>Key Outback and Rural Routes: All</p> <p>Major Transport Routes: PO All</p> <p>Murray Darling Basin: All</p>

Class of Development	Applicable Policies			
	Zone	General Development Policies	Subzone (applies only in the area affected by the Subzone)	Overlay (applies only in the area affected by the Overlay)
		<p>Infrastructure and Renewable Energy Facilities [Wastewater Services]: PO 12.1, 12.2</p> <p>Interface Between Land Uses [General Land Use Compatibility]: PO 1.2</p> <p>Interface Between Land Uses [Hours of Operation]: PO 2.1</p> <p>Interface Between Land Uses [Activities Generating Noise or Vibration]: PO 4.2</p> <p>Interface Between Land Uses [Light Spill]: PO 6.1, 6.2</p> <p>Transport, Access and Parking [Movement Systems]: PO 1.1, 1.2, 1.3, 1.4</p>		<p>Native Vegetation: PO 1.1, 1.2</p> <p>Prescribed Water Resources Area: All</p> <p>Prescribed Wells Area: All</p> <p>Sloping Land: All</p> <p>State Heritage Place: All</p> <p>State Significant Native Vegetation: All</p> <p>Urban Transport Routes: PO All</p> <p>Water Protection Area: All</p> <p>Water Resources: All</p>

Class of Development	Applicable Policies			
	Zone	General Development Policies	Subzone (applies only in the area affected by the Subzone)	Overlay (applies only in the area affected by the Overlay)
		<p>Transport, Access and Parking [Sightlines]: PO 2.1, 2.2</p> <p>Transport, Access and Parking [Vehicle Access]: PO 3.1, 3.3, 3.4, 3.5, 3.7, 3.8, 3.9</p> <p>Transport, Access and Parking [Vehicle Parking Rates]: PO 5.1</p> <p>Transport, Access and Parking [Vehicle Parking Areas]: PO 6.1, 6.2, 6.5, 6.6</p>		
All other Code Assessed Development	All	All	None	Any Relevant Overlays: All

The following policies are applicable to the assessment of the identified Class of Development. Policies referred to are Performance Outcome policies, and any associated Designated Performance Features. Relevant Desired Outcomes are not listed, but automatically apply in relation to a Performance Assessed Development.

Where a development comprises more than one Class of Development the relevant policies will be taken to be the sum of the applicable policies for each Class of Development.

Table 4 –Restricted Development Classification

Class of Development The following Classes of Development are classified as Restricted subject to any 'Exclusions'	Exclusions
Shop	Where: (a) the gross leasable floor area is no more than 250m ² ; or (b) it is ancillary to and located on the same allotment as an airfield passenger terminal.

Assessment Provisions (AP)

Desired Outcome (DO)

DO 1

A zone providing for aviation operations together with allied and complementary activities to support the long term ongoing use and expansion of airfield development and activities for commercial freight and passenger transport as well as aviation related recreational pursuits.

Performance Outcomes and Deemed to Satisfy / Designated Performance Outcome Criteria

Land Use

PO 1.1

Development primary catering for take-off and landing, on-ground movement, maintenance, repair and storage of aircraft, as well as facilities associated with the handling of freight and passengers to enhance the safe and efficient transportation of people and cargo by air.

DTS/DPF 1.1

Development comprises one or more of the following land uses:

- Aircraft operational facilities beacons, transmitting installations and their associated towers
- Aircraft control tower
- Light industry associated with, and ancillary to, aviation activities
- Passenger and/or air freight terminal
- Aircraft hangar
- Shop within the terminal building
- Store associated with, and ancillary to, aviation activities
- Fuel depot associated with aviation and airport related purposes
- Office associated with, and ancillary to, aviation activities
- Flight simulation and training facility.

PO 1.2

Development does not impede aviation operations and the expansion of airfields.

DTS/DPF 1.2

None are applicable.

Built Form and Character

PO 2.1

Development of a scale and design consistent with the role and function of the airfield and complementary to the wider setting.

DTS/DPF 2.1

None are applicable.

Land Division

PO 3.1

Land division suitable for the intended use of the land where it maintains the efficient and safety operations of the airfield.

DTS/DPF 3.1

None are applicable.

Hazard Management

PO 4.1

Movement between aircraft taxiways and open runway corridors and areas used for non-aviation purposes is regulated through the incorporation of fencing or other barriers to mitigate hazard to aircraft operations and provide for the safety of users and occupiers of land use for non-aviation purposes.

DTS/DPF 4.1

None are applicable.

PO 4.2

Landscaping uses species to minimise the nesting and attraction of birds and spread of leaf and other debris to mitigate hazard to aircraft.

DTS/DPF 4.2

None are applicable.

Advertisements

PO 5.1

Advertisements limited to those in connection with the terminal building and the display of business services on non-residential premises to mitigate visual clutter and untidiness.

DTS/DPF 5.1

None are applicable.

Procedural Matters (PM)

Notification of Performance assessed development

All classes of performance assessed development are excluded from notification except where they involve any of the following:

- (a) the site of the development is adjacent land to land in a different zone that is located within the area of council
- (b) development identified as “all other code assessed development” in Infrastructure (Airfield) Zone Table 3.

Placement of Notices – Exemptions for Performance Assessed Development

None specified.

Placement of Notices – Exemptions for Restricted Development

None specified.

Open Space Zone

Table 1 – Accepted Development Classification

Class of Development The following Classes of Development are classified as Accepted Development subject to meeting the 'Accepted Development Classification Criteria'	Accepted Development Classification Criteria
Building work on railway land	<ol style="list-style-type: none">1 Building work is associated with a railway2 It is situated (or to be situated) on railway land3 It is required for the conduct or maintenance of railway activities.
Carport Except where any of the following apply:	<ol style="list-style-type: none">1 The development will not be built, or encroach, on an area that is, or will be, required for a sewerage system or waste control system2 It is ancillary to a dwelling erected on the site

<ul style="list-style-type: none"> • Character Preservation District Overlay • Coastal Areas Overlay • Hazards (Acid Sulfate Soils) Overlay • Hazards (Flooding) Overlay • Character Area Overlay • Historic Area Overlay • Local Heritage Place Overlay • State Heritage Area Overlay • State Heritage Place Overlay • Native Vegetation Overlay • State Significant Native Vegetation Overlay • Ramsar Wetlands Overlay • River Murray Flood Plain Overlay • Sloping Land Overlay • Future Road Widening Overlay where an existing access is altered or a new access is created • Key Railway Crossings Overlay where an existing access is altered or a new access is created • Key Outback and Rural Routes Overlay where an existing access is altered or a new access is created • Major Urban Transport Routes Overlay where an existing access is altered or a new access is created 	<ol style="list-style-type: none"> 3 Primary street setback – at least 5.5m from the primary street boundary and as far back as the building line of the building to which it is ancillary 4 Secondary street setback – at least 900mm from the boundary of the allotment (if the land has boundaries on two or more roads) 5 Total floor area - does not exceed 40m² 6 Post height - does not exceed 3m measured from natural ground level (and not including a gable end) 7 Building height - does not exceed 5m 8 If situated on or abutting a boundary (not being a boundary with a primary street or secondary street) – a length not exceeding 10m unless: <ol style="list-style-type: none"> (a) a longer wall or structure exists on the adjacent site and is situated on the same allotment boundary; and (b) the proposed wall or structure will be built along the same length of boundary as the existing adjacent wall or structure to the same or lesser extent 9 If the carport abuts or is situated on the boundary of the allotment (not being a boundary with a primary street or secondary street): <ol style="list-style-type: none"> (a) it will not result in all relevant walls or structures located along the boundary exceeding 45% of the length of the boundary; and (b) it will not be located within 3m of any other wall along the same boundary unless on an adjacent site on that boundary there is an existing wall of a building that would be adjacent to or abut the proposed wall or structure 10 The total roofed area of all existing or proposed buildings on the allotment does not exceed 60% of the area of the allotment 11 Door opening for vehicle access – does not exceed, in total, 7m in width or 50% of the width of the allotment frontage (whichever lesser) 12 Internal dimensions – does not exceed 3.2m in width and 6m in length between all fences, walls and doors 13 The carport: <ol style="list-style-type: none"> (a) is located so that vehicle access: <ol style="list-style-type: none"> i. is provided via a lawfully existing or authorised driveway or access point or an access point for which consent has been granted as part of an application for the division of land; or
--	--

<ul style="list-style-type: none"> • Non-stop Corridor Overlay where an existing access is altered or a new access is created • Urban Transport Routes Overlay where an existing access is altered or a new access is created • Water Resources Overlay 	<ul style="list-style-type: none"> ii. will use a driveway that: <ul style="list-style-type: none"> A. is not located within 6 metres of an intersection of 2 or more roads or a pedestrian actuated crossing; and B. will not interfere with an item of street furniture (including directional signs, lighting, seating and weather shelters), other infrastructure, or a tree; or iii. if adjacent a kerbed road, will be via a kerb that is designed to allow a vehicle to roll over it; and (b) is located so that the gradient from the place of access on the boundary of the allotment to the finished floor level at the front of the carport when the work is completed is not steeper than 1:4 on average; and (c) The centre of the driveway at the public road boundary is no more than 25 degree deviation from the centre of the front of the covered car parking space for which it provides vehicle access
<p>Demolition Except where any of the following apply:</p> <ul style="list-style-type: none"> • Historic Area Overlay • A Historic Shipwreck identified in the Historic Shipwrecks Overlay • A Local Heritage Place identified in the Local Heritage Place Overlay • State Heritage Area Overlay • A State Heritage Place identified in the State Heritage Place Overlay 	<p>None.</p>
<p>Internal building work Except where any of the following apply:</p> <ul style="list-style-type: none"> • A Historic Shipwreck identified in the Historic Shipwrecks Overlay • A Local Heritage Place identified in the Local Heritage Place Overlay • State Heritage Area Overlay 	<ol style="list-style-type: none"> 1 There will be no increase in the total floor area of the building 2 There will be no alteration to the external appearance of the building.

<ul style="list-style-type: none"> • A State Heritage Place identified in the State Heritage Place Overlay 	
<p>Outbuilding (in the form of a garage) Except where any of the following apply:</p> <ul style="list-style-type: none"> • Character Preservation District Overlay • Coastal Areas Overlay • Hazards (Acid Sulfate Soils) Overlay • Hazards (Flooding) Overlay • Character Area Overlay • Historic Area Overlay • Local Heritage Place Overlay • State Heritage Area Overlay • State Heritage Place Overlay • Native Vegetation Overlay • State Significant Native Vegetation Overlay • Ramsar Wetlands Overlay • River Murray Flood Plain Overlay • Sloping Land Overlay • Future Road Widening Overlay where an existing access is altered or a new access is created • Key Railway Crossings Overlay where an existing access is altered or a new access is created • Key Outback and Rural Routes Overlay where an existing access is altered or a new access is created 	<ol style="list-style-type: none"> 1 The development will not be built, or encroach, on an area that is, or will be, required for a sewerage system or waste control system 2 It is detached from and ancillary to a dwelling erected on the site. 3 Primary street setback – at least 5.5m from the primary street boundary and as far back as the building line of the building to which it is ancillary 4 Secondary street setback – at least 900mm from the boundary of the allotment (if the land has boundaries on two or more roads) 5 Total floor area - does not exceed 40m² 6 Wall height - does not exceed 3m measured from natural ground level (and not including a gable end) 7 Building height - does not exceed 5m 8 If situated on or abutting a boundary (not being a boundary with a primary street or secondary street) – a length not exceeding 10m unless: <ol style="list-style-type: none"> (a) a longer wall or structure exists on the adjacent site and is situated on the same allotment boundary; and (b) the proposed wall or structure will be built along the same length of boundary as the existing adjacent wall or structure to the same or lesser extent 9 If the outbuilding abuts or is situated on the boundary of the allotment (not being a boundary with a primary street or secondary street): <ol style="list-style-type: none"> (a) it will not result in all relevant walls or structures located along the boundary exceeding 45% of the length of the boundary; and (b) it will not be located within 3m of any other wall along the same boundary unless on an adjacent site on that boundary there is an existing wall of a building that would be adjacent to or abut the proposed wall or structure 10 Total roofed area of all existing and proposed buildings on the allotment - does not exceed 60% 11 Internal dimensions – exceed 3.2m in width and 6m in length between all walls and doors 12 Door opening for vehicle access – does not exceed, in total, 7m in width or 50% of the width of the allotment frontage (whichever lesser) 13 The garage:

<ul style="list-style-type: none"> • Major Urban Transport Routes Overlay where an existing access is altered or a new access is created • Non-stop Corridor Overlay where an existing access is altered or a new access is created • Urban Transport Routes Overlay where an existing access is altered or a new access is created • Water Resources Overlay 	<p>(a) is located so that vehicle access:</p> <ul style="list-style-type: none"> i. is provided via a lawfully existing or authorised driveway or access point or an access point for which consent has been granted as part of an application for the division of land; or ii. will use a driveway that: <ul style="list-style-type: none"> A. is not located within 6 metres of an intersection of 2 or more roads or a pedestrian actuated crossing; and B. will not interfere with an item of street furniture (including directional signs, lighting, seating and weather shelters), other infrastructure, or a tree; or iii. if adjacent a kerbed road, will be via a kerb that is designed to allow a vehicle to roll over it; and <p>(b) is located so that the gradient from the place of access on the boundary of the allotment to the finished floor level at the front of the carport when the work is completed is not steeper than 1:4 on average; and</p> <p>(c) The centre of the driveway at the public road boundary is no more than 25 degree deviation from the centre of the front of the covered car parking space for which it provides vehicle access</p> <p>14 If clad in sheet metal—is pre-colour treated or painted in a non-reflective colour.</p>
<p>Outbuilding (not being a garage) Except where any of the following apply:</p> <ul style="list-style-type: none"> • Character Preservation District Overlay • Coastal Areas Overlay • Hazards (Acid Sulfate Soils) Overlay • Hazards (Flooding) Overlay • Character Area Overlay • Historic Area Overlay • Local Heritage Place Overlay • State Heritage Area Overlay • State Heritage Place Overlay 	<ol style="list-style-type: none"> 1 The development will not be built, or encroach, on an area that is, or will be, required for a sewerage system or waste control system 2 It is detached from and ancillary to a dwelling erected on the site 3 Primary street setback – at least as far back as the building line of the building to which it is ancillary 4 Secondary street setback – at least 900mm from the boundary of the allotment (if the land has boundaries on two or more roads) 5 Side boundary setbacks – at least 900mm from the boundary of the allotment 6 Total floor area does not exceed 40m² 7 Wall height - does not exceed 3m measured from natural ground level (and not including a gable end) 8 Building height - does not exceed 5m 9 If situated on or abutting a boundary (not being a boundary with a primary street or secondary street) – a length not exceeding 10m unless:

<ul style="list-style-type: none"> • Native Vegetation Overlay • State Significant Native Vegetation Overlay • Ramsar Wetlands Overlay • River Murray Flood Plain Overlay • Sloping Land Overlay • Water Resources Overlay 	<p>(a) a longer wall or structure exists on the adjacent site and is situated on the same allotment boundary; and</p> <p>(b) the proposed wall or structure will be built along the same length of boundary as the existing adjacent wall or structure to the same or lesser extent</p> <p>10 If the outbuilding abuts or is situated on the boundary of the allotment (not being a boundary with a primary street or secondary street):</p> <p>(a) it will not result in all relevant walls or structures located along the boundary exceeding 45% of the length of the boundary; and</p> <p>(b) will not be located within 3m of any other wall along the same boundary unless on an adjacent site on that boundary there is an existing wall of a building that would be adjacent to or abut the proposed wall or structure</p> <p>11 Total roofed area of all existing and proposed buildings on the allotment - does not exceed 60%</p> <p>12 If clad in sheet metal—is pre-colour treated or painted in a non-reflective colour.</p>
<p>Shade sail Except where any of the following apply:</p> <ul style="list-style-type: none"> • Character Preservation District Overlay • Coastal Areas Overlay • Hazards (Acid Sulfate Soils) Overlay • Character Area Overlay • Historic Area Overlay • Local Heritage Place Overlay • State Heritage Area Overlay • State Heritage Place Overlay • Native Vegetation Overlay • State Significant Native Vegetation Overlay • Ramsar Wetlands Overlay • River Murray Flood Plain Overlay 	<ol style="list-style-type: none"> 1 The development will not be built, or encroach, on an area that is, or will be, required for a sewerage system or waste control system 2 Shade sail consists of permeable material 3 The total area of the sail - does not exceed 40m² 4 No part of the shade sail will be: <ol style="list-style-type: none"> (a) 3m above ground or floor level (depending on where it is situated) at any place within 900mm of a boundary of the allotment (b) 5m above ground or floor level (depending on where it is situated) within any other part of the allotment 5 Primary street setback – at least as far back as the building line of the building to which it is ancillary 6 If any part of the sail will be situated on a boundary of the allotment, the length of sail along a boundary does not exceed 8m 7 In a case where any part of the sail or a supporting structure will be situated on a side boundary of the allotment — the length of the sail and any such supporting structure together with all relevant walls or structures located along the boundary will not exceed 45% of the length of the boundary.

<ul style="list-style-type: none"> • Sloping Land Overlay • Water Resources Overlay 	
<p>Solar photovoltaic panels (roof mounted) Except where any of the following apply:</p> <ul style="list-style-type: none"> • Historic Area Overlay • A Local Heritage Place identified in the Local Heritage Place Overlay • State Heritage Area Overlay • A State Heritage Place identified in the State Heritage Place Overlay 	<ol style="list-style-type: none"> 1 Panels are installed parallel to the roof of a building and with the underside surface of the panel not being more than 100mm above the surface of the roof 2 Panels and associated components do not overhang any part of the roof 3 Does not apply to system with a generating capacity of more than 5MW that is to be connected to the State's power system.
<p>Verandah Except where any of the following apply:</p> <ul style="list-style-type: none"> • Character Preservation District Overlay • Coastal Areas Overlay • Hazards (Acid Sulfate Soils) Overlay • Hazards (Flooding) Overlay • Character Area Overlay • Historic Area Overlay • Local Heritage Place Overlay • State Heritage Area Overlay • State Heritage Place Overlay • Native Vegetation Overlay • State Significant Native Vegetation Overlay • Ramsar Wetlands Overlay • River Murray Flood Plain Overlay • Water Resources Overlay 	<ol style="list-style-type: none"> 1 The development will not be built, or encroach, on an area that is, or will be, required for a sewerage system or waste control system 2 It is ancillary to a dwelling erected on the site 3 Primary street setback – as far back as the building line of the building to which it is ancillary 4 Total floor area - does not exceed 40m² 5 Post height - does not exceed 3m measured from natural ground level 6 Building height - does not exceed 5m 7 Length - does not exceed 10m if any part of the structure abuts or is situated on a boundary of the allotment 8 Total roofed area of all existing and proposed buildings on the allotment - does not exceed 60%.

Water tank (above ground)

Except where any of the following apply:

- Character Preservation District Overlay
- Coastal Areas Overlay
- Hazards (Flooding) Overlay
- Character Area Overlay
- Historic Area Overlay
- Local Heritage Place Overlay
- State Heritage Area Overlay
- State Heritage Place Overlay
- Native Vegetation Overlay
- State Significant Native Vegetation Overlay
- Ramsar Wetlands Overlay
- River Murray Flood Plain Overlay
- Sloping Land Overlay
- Water Resources Overlay

- 29 The development will not be built, or encroach, on an area that is, or will be, required for a sewerage system or waste control system
- 30 The tank is part of a roof drainage system
- 31 Total floor area - not exceeding 15m²
- 32 The tank is located wholly above ground
- 33 Tank height – does not exceed 4m above natural ground level
- 34 Primary street setback – at least as far back as the building line of the building to which it is ancillary
- 35 In the case of a tank made of metal – the tank is pre-colour treated or painted in a non-reflective colour.

Water tank (underground)

Except where any of the following apply:

- Character Preservation District Overlay
- Coastal Areas Overlay
- Hazards (Acid Sulfate Soils) Overlay
- Native Vegetation Overlay
- State Significant Native Vegetation Overlay
- Ramsar Wetlands Overlay
- Sloping Land Overlay

- 9 The development will not be built, or encroach, on an area that is, or will be, required for a sewerage system or waste control system
- 10 The tank (including any associated pump) is located wholly below the level of the ground.

- Water Resources Overlay

Table 2 – Deemed-to-Satisfy Development Classification

Class of Development The following Classes of Development are classified as Deemed-to-Satisfy Development subject to meeting the 'Deemed-to-Satisfy Development Classification Criteria'	Deemed-to-Satisfy Development Classification Criteria Provisions referred to are Deemed-to-Satisfy Criteria Where a development comprises more than one Class of Development the relevant criteria will be taken to be the sum of the criteria for each Class of Development.			
	Zone	General Development Policies	Subzone (applies only in the area affected by the Subzone)	Overlay (applies only in the area affected by the Overlay)
Advertisement Except where any of the following apply: <ul style="list-style-type: none"> • Coastal Areas Overlay • Character Area Overlay • Character Preservation District Overlay • Hazards (Flooding) Overlay • Historic Area Overlay • Local Heritage Place Overlay • Marine Parks (Managed Use) • Marine Parks (Restricted Use) 	None	Clearance from Overhead Powerlines: DTS 1.1 Advertisements [Appearance]: DTS 1.1, 1.3, 1.4 Advertisements [Proliferation of Advertisements]: DTS 2.1, 2.2 Advertisements [Advertising Content]: DTS 3.1 Advertisements [Amenity Content]: DTS 4.1 Advertising [Safety]: DTS 5.1, 5.2, 5.3, 5.4, 5.5	None	Advertising Near Signalised Intersections: DTS 1.1 Airport Building Heights (Aircraft Landing Areas) Overlay: DTS 1.1 Airport Building Heights (Regulated) Overlay: DTS 1.1, 1.2 Building Near Airfields Overlay: DTS 1.1 Defence Aviation Area: DTS 1.1, 1.3 Future Road Widening Overlay: DTS 1.1 Hazards (Acid Sulfate Soil): DTS 1.1 Key Outback and Rural Routes: DTS 8.1 Major Transport Routes: DTS 8.1, 10.1

Class of Development

The following Classes of Development are classified as Deemed-to-Satisfy Development subject to meeting the 'Deemed-to-Satisfy Development Classification Criteria'

Deemed-to-Satisfy Development Classification Criteria

Provisions referred to are Deemed-to-Satisfy Criteria

Where a development comprises more than one Class of Development the relevant criteria will be taken to be the sum of the criteria for each Class of Development.

	Zone	General Development Policies	Subzone (applies only in the area affected by the Subzone)	Overlay (applies only in the area affected by the Overlay)
<ul style="list-style-type: none"> • Non-stop Corridor Overlay • Ramsar Wetlands Overlay • River Murray Flood Plain Overlay • Sloping Land Overlay • State Heritage Area Overlay • State Heritage Place Overlay • Water Resources Overlay 				<p>State Significant Native Vegetation Overlay: DTS 1.1 Native Vegetation Overlay: DTS 1.1 Urban Transport Routes Overlay: DTS 8.1, 10.1</p>

Table 3 – Applicable Policies for Performance Assessed Development

Class of Development	Applicable Policies			
	Zone	General Development Policies	Subzone (applies only in the area affected by the Subzone)	Overlay (applies only in the area affected by the Overlay)
	<p>The following provisions are applicable to the assessment of the identified Class of Development.</p> <p>Provisions referred to are Performance Outcome policies, and any associated Designated Performance Features. Relevant Desired Outcomes are not listed, but automatically apply in relation to a Performance Assessed Development.</p> <p>Where a development comprises more than one Class of Development the relevant policies will be taken to be the sum of the applicable policies for each Class of Development.</p>			
Advertisement	[Built Form and Character]: PO 2.1	<p>Advertisements [Appearance]: PO 1.1, 1.2, 1.3, 1.4</p> <p>Advertisements [Proliferation of Advertisements]: PO 2.1, 2.2</p> <p>Advertisements [Advertising Content]: PO 3.1</p> <p>Advertisements [Amenity Content]: PO 4.1</p> <p>Advertising [Safety]: PO 5.1, 5.2, 5.3, 5.4, 5.5</p>	None	<p>Advertising Near Signalised Intersections Overlay: PO 1.1</p> <p>Airport Building Heights (Aircraft Landing Area) Overlay: PO 1.1</p> <p>Airport Building Heights (Regulated) Overlay: PO 1.1, 1.2</p> <p>Building Near Airfields Overlay: PO 1.1</p> <p>Character Preservation District Overlay: PO 2.1, 2.2, 3.2, 3.3, 3.4, 3.5, 3.6, 4.1</p> <p>Coastal Areas Overlay: All</p> <p>Character Area Overlay: PO 1.1, 1.2, 1.3, 1.5, 3.3, 5.2</p>

Class of Development

Applicable Policies

The following provisions are applicable to the assessment of the identified Class of Development.

Provisions referred to are Performance Outcome policies, and any associated Designated Performance Features. Relevant Desired Outcomes are not listed, but automatically apply in relation to a Performance Assessed Development.

Where a development comprises more than one Class of Development the relevant policies will be taken to be the sum of the applicable policies for each Class of Development.

Zone	General Development Policies	Subzone (applies only in the area affected by the Subzone)	Overlay (applies only in the area affected by the Overlay)
-------------	-------------------------------------	--	--

		Clearance from Overhead Powerlines: PO 1.1	Defence Aviation Area Overlay: PO 1.1, 1.3 Future Road Widening Overlay: All Hazards (Acid Sulfate Soil) Overlay: All Hazards (Flooding) Overlay: All Historic Area Overlay: All Key Outback and Rural Routes Overlay: PO 8.1, 10.1 Local Heritage Place Overlay: All Major Transport Routes Overlay: PO 8.1, 10.1 Marine Parks (Managed Use) Overlay: All Marine Parks (Restricted Use) Overlay: All
--	--	--	---

Class of Development

Applicable Policies

The following provisions are applicable to the assessment of the identified Class of Development.

Provisions referred to are Performance Outcome policies, and any associated Designated Performance Features. Relevant Desired Outcomes are not listed, but automatically apply in relation to a Performance Assessed Development.

Where a development comprises more than one Class of Development the relevant policies will be taken to be the sum of the applicable policies for each Class of Development.

Zone

General Development Policies

Subzone
(applies only in the area affected by the Subzone)

Overlay
(applies only in the area affected by the Overlay)

Native Vegetation Overlay: PO 1.1, 1.2
 Non-stop Corridor Overlay: All
 Ramsar Wetlands Overlay: All
 River Murray Flood Plain Overlay: All
 Sloping Land Overlay: All
 State Heritage Area Overlay: All
 State Heritage Place Overlay: All
 State Significant Native Vegetation Overlay: PO 1.1
 Urban Transport Routes Overlay: PO 8.1, 10.1
 Water Resources Overlay: All

Class of Development

Applicable Policies

The following provisions are applicable to the assessment of the identified Class of Development.

Provisions referred to are Performance Outcome policies, and any associated Designated Performance Features. Relevant Desired Outcomes are not listed, but automatically apply in relation to a Performance Assessed Development.

Where a development comprises more than one Class of Development the relevant policies will be taken to be the sum of the applicable policies for each Class of Development.

Zone

General Development Policies

Subzone

(applies only in the area affected by the Subzone)

Overlay

(applies only in the area affected by the Overlay)

Outbuilding (not being a garage)

Verandah

[Land Use and Intensity]: PO 1.1, 1.2

[Built Form and Character]: PO 2.1, 2.3

[Concept Plans]: PO 4.1

Clearance from Overhead Powerlines: PO 1.1

Design in Urban Areas [All Residential Development – Ancillary Development]: PO 17.1, 17.2

None

Airport Building Heights (Aircraft Landing Area) Overlay: PO 1.1

Airport Building Heights (Regulated) Overlay: PO 1.1, 1.2

Building Near Airfields Overlay: PO 1.1, 1.2

Character Preservation District Overlay: All

Character Area Overlay: All

Coastal Areas Overlay: All

Defence Aviation Area Overlay: PO 1.1, 1.3

Class of Development

Applicable Policies

The following provisions are applicable to the assessment of the identified Class of Development.

Provisions referred to are Performance Outcome policies, and any associated Designated Performance Features. Relevant Desired Outcomes are not listed, but automatically apply in relation to a Performance Assessed Development.

Where a development comprises more than one Class of Development the relevant policies will be taken to be the sum of the applicable policies for each Class of Development.

Zone

General Development Policies

Subzone

(applies only in the area affected by the Subzone)

Overlay

(applies only in the area affected by the Overlay)

- Future Road Widening Overlay: All
- Hazards (Acid Sulfate Soils) Overlay: All
- Hazards (Bushfire - General Risk) Overlay: All
- Hazards (Bushfire - High Risk) Overlay: All
- Hazards (Bushfire - Medium Risk) Overlay: All
- Hazards (Bushfire - Regional) Overlay: All
- Hazards (Flooding) Overlay: All

Class of Development

Applicable Policies

The following provisions are applicable to the assessment of the identified Class of Development.

Provisions referred to are Performance Outcome policies, and any associated Designated Performance Features. Relevant Desired Outcomes are not listed, but automatically apply in relation to a Performance Assessed Development.

Where a development comprises more than one Class of Development the relevant policies will be taken to be the sum of the applicable policies for each Class of Development.

Zone

General Development Policies

Subzone

(applies only in the area affected by the Subzone)

Overlay

(applies only in the area affected by the Overlay)

- Historic Area Overlay: All
- Key Outback and Rural Routes Overlay: PO 8.1, 10.1
- Local Heritage Place Overlay: All
- Major Transport Routes Overlay: PO 8.1, 10.1
- Marine Parks (Managed Use) Overlay: All
- Marine Parks (Restricted Use) Overlay: All
- Mount Lofty Ranges Catchment (Area 1): All

Class of Development

Applicable Policies

The following provisions are applicable to the assessment of the identified Class of Development.

Provisions referred to are Performance Outcome policies, and any associated Designated Performance Features. Relevant Desired Outcomes are not listed, but automatically apply in relation to a Performance Assessed Development.

Where a development comprises more than one Class of Development the relevant policies will be taken to be the sum of the applicable policies for each Class of Development.

Zone

General Development Policies

Subzone

(applies only in the area affected by the Subzone)

Overlay

(applies only in the area affected by the Overlay)

- Mount Lofty Ranges Catchment (Area 2) Overlay: All
- Native Vegetation Overlay: PO 1.1, 1.2
- Ramsar Wetlands Overlay: All
- River Murray Flood Plain Overlay: All
- Sloping Land Overlay: All
- State Heritage Area Overlay: All
- State Heritage Place Overlay: All
- State Significant Native Vegetation Overlay: PO 1.1

Class of Development

Applicable Policies

The following provisions are applicable to the assessment of the identified Class of Development.

Provisions referred to are Performance Outcome policies, and any associated Designated Performance Features. Relevant Desired Outcomes are not listed, but automatically apply in relation to a Performance Assessed Development.

Where a development comprises more than one Class of Development the relevant policies will be taken to be the sum of the applicable policies for each Class of Development.

Zone	General Development Policies	Subzone (applies only in the area affected by the Subzone)	Overlay (applies only in the area affected by the Overlay)
-------------	-------------------------------------	--	--

			Urban Transport Routes Overlay: PO 8.1, 10.1 Water Protection Area Overlay: All Water Resources Overlay: All
--	--	--	--

Shop	[Land Use and Intensity]: PO 1.1, 1.2, 1.3 [Built Form and Character]: PO 2.1 [Concept Plans]: PO 4.1	Clearance from Overhead Powerlines: PO 1.1 Design in Urban Areas [External Appearance]: PO 1.4, 1.5 Design in Urban Areas [Car Parking Appearance]: PO 6.4, 6.5 Design in Urban Areas [Water Sensitive Design]: PO 42.1, 42.3	None Airport Building Heights (Aircraft Landing Area) Overlay: PO 1.1 Airport Building Heights (Regulated) Overlay: PO 1.1, 1.2 Building Near Airfields Overlay: PO 1.1, 1.2 Character Preservation District Overlay: All
-------------	---	--	---

Class of Development

Applicable Policies

The following provisions are applicable to the assessment of the identified Class of Development.

Provisions referred to are Performance Outcome policies, and any associated Designated Performance Features. Relevant Desired Outcomes are not listed, but automatically apply in relation to a Performance Assessed Development.

Where a development comprises more than one Class of Development the relevant policies will be taken to be the sum of the applicable policies for each Class of Development.

Zone

General Development Policies

Subzone

(applies only in the area affected by the Subzone)

Overlay

(applies only in the area affected by the Overlay)

Interface Between Land Uses [Hours of Operation]: PO 2.1

Interface Between Land Uses [Overshadowing]: PO 3.1, 3.2

Infrastructure and Renewable Energy Facilities [Water Supply]: PO 11.1

Infrastructure and Renewable Energy Facilities [Wastewater Services]: PO 12.1, 12.2

Transport, Access and Parking [Movement Systems]: PO 1.4

Transport, Access and Parking [Vehicle Access]: PO 3.1, 3.5, 3.6

Coastal Areas Overlay: All
 Defence Aviation Area Overlay: PO 1.1, 1.3
 Future Road Widening Overlay: All
 Hazards (Acid Sulfate Soils) Overlay: All
 Hazards (Bushfire - General Risk) Overlay: All
 Hazards (Bushfire - High Risk) Overlay: All
 Hazards (Bushfire - Medium Risk) Overlay: All

Class of Development

Applicable Policies

The following provisions are applicable to the assessment of the identified Class of Development.

Provisions referred to are Performance Outcome policies, and any associated Designated Performance Features. Relevant Desired Outcomes are not listed, but automatically apply in relation to a Performance Assessed Development.

Where a development comprises more than one Class of Development the relevant policies will be taken to be the sum of the applicable policies for each Class of Development.

Zone

General Development Policies

Subzone

(applies only in the area affected by the Subzone)

Overlay

(applies only in the area affected by the Overlay)

Transport, Access and Parking [Vehicle Parking Rates]: PO 5.1

Transport, Access and Parking [Vehicle Parking Areas]: PO 6.1, 6.6

Transport, Access and Parking [Bicycle Parking in Designated Areas]: PO 9.1

Hazards (Bushfire - Urban Interface) Overlay: All

Hazards (Bushfire - Regional) Overlay: All

Hazards (Flooding) Overlay: All

Historic Area Overlay: All

Key Outback and Rural Routes Overlay: All

Key Railway Crossings Overlay: PO 1.1

Local Heritage Place Overlay: All

Class of Development

Applicable Policies

The following provisions are applicable to the assessment of the identified Class of Development.

Provisions referred to are Performance Outcome policies, and any associated Designated Performance Features. Relevant Desired Outcomes are not listed, but automatically apply in relation to a Performance Assessed Development.

Where a development comprises more than one Class of Development the relevant policies will be taken to be the sum of the applicable policies for each Class of Development.

Zone

General Development Policies

Subzone
(applies only in the area affected by the Subzone)

Overlay
(applies only in the area affected by the Overlay)

- Major Transport Routes Overlay: All
- Marine Parks (Managed Use) Overlay: All
- Marine Parks (Restricted Use) Overlay: All
- Mount Lofty Ranges Catchment (Area 1) Overlay: All
- Mount Lofty Ranges Catchment (Area 2) Overlay: All
- Murray Darling Basin Overlay: All

Class of Development

Applicable Policies

The following provisions are applicable to the assessment of the identified Class of Development.

Provisions referred to are Performance Outcome policies, and any associated Designated Performance Features. Relevant Desired Outcomes are not listed, but automatically apply in relation to a Performance Assessed Development.

Where a development comprises more than one Class of Development the relevant policies will be taken to be the sum of the applicable policies for each Class of Development.

Zone

General Development Policies

Subzone

(applies only in the area affected by the Subzone)

Overlay

(applies only in the area affected by the Overlay)

- Native Vegetation Overlay: PO 1.1, 1.2
- Prescribed Water Resources Area Overlay: All
- Prescribed Watercourses Overlay: All
- Prescribed Wells Area Overlay: All
- Ramsar Wetlands Overlay: All
- River Murray Flood Plain Overlay: All
- River Murray Tributaries Area Overlay: All

Class of Development	Applicable Policies			
	Zone	General Development Policies	Subzone (applies only in the area affected by the Subzone)	Overlay (applies only in the area affected by the Overlay)
<p>The following provisions are applicable to the assessment of the identified Class of Development.</p> <p>Provisions referred to are Performance Outcome policies, and any associated Designated Performance Features. Relevant Desired Outcomes are not listed, but automatically apply in relation to a Performance Assessed Development.</p> <p>Where a development comprises more than one Class of Development the relevant policies will be taken to be the sum of the applicable policies for each Class of Development.</p>				<p>Sloping Land Overlay: All</p> <p>State Heritage Area Overlay: A;;</p> <p>State Heritage Place Overlay: All</p> <p>State Significant Native Vegetation Overlay: PO 1.1</p> <p>Traffic Generating Development Overlay: All</p> <p>Urban Transport Routes Overlay: All</p> <p>Water Protection Area Overlay: All</p> <p>Water Resources Overlay: All</p>

Class of Development

Applicable Policies

The following provisions are applicable to the assessment of the identified Class of Development.

Provisions referred to are Performance Outcome policies, and any associated Designated Performance Features. Relevant Desired Outcomes are not listed, but automatically apply in relation to a Performance Assessed Development.

Where a development comprises more than one Class of Development the relevant policies will be taken to be the sum of the applicable policies for each Class of Development.

Zone

General Development Policies

Subzone

(applies only in the area affected by the Subzone)

Overlay

(applies only in the area affected by the Overlay)

All other Code Assessed Development

All

All

None

All

Table 4 – Restricted Development Classification

Class of Development The following Classes of Development are classified as Restricted subject to any 'Exclusions'	Exclusions
Nil	

Assessment Provisions (AP)

Desired Outcome (DO)

DO 1

Areas of natural and landscaped open space that provide visual relief to the built environment for the enjoyment of the community.

Performance Outcomes and Deemed to Satisfy / Designated Performance Outcome Criteria

Land Use and Intensity

PO 1.1

Development is associated with or ancillary to the provision of unstructured outdoor passive and active recreation facilities.

DTS/DPF 1.1

Development comprises one or more of the following land uses:

- Open space
- Outdoor sports courts
- Recreation area
- Sporting ovals and fields

PO 1.2

Buildings are limited in number and size to provide a natural, landscaped setting.

DTS/DPF 1.2

None are applicable.

PO 1.3

Shops including restaurants are of a scale that is subordinate to the principal open space and recreation use of the land.

DTS/DPF 1.3

Shop gross leasable floor area does not exceed 50m².

PO 1.4

Offices are of a scale that is subordinate to the principal open space use of the land.

DTS/DPF 1.4

Office gross leasable floor area does not exceed 80m².

Built Form and Character

PO 2.1

Development sited unobtrusively so as not to spoil the open space character or interrupt views of natural or landscape features.

DTS/DPF 2.1

None are applicable.

PO 2.2

Playgrounds are ancillary to and enhance enjoyment of areas of open space.

DTS/DPF 2.2

Playgrounds:

- (a) do not occupy more than 200m² in area; and
- (b) have a building height that does not exceed 3m.

PO 2.3

Outbuildings are of a scale that mitigates visual impacts of buildings on natural or landscape features.

DTS/DPF 2.3

Outbuildings have a:

- (a) floor area that does not exceed 80m²;
- (b) wall height that does not exceed 3m; and
- (c) building height that does not exceed 5m.

Land Division

PO 3.1

Land division supports the provision of open space

DTS/DPF 3.1

Land division is for the purposes of:

- (a) the creation of a public road or a public reserve; or
- (b) a minor adjustment of allotment boundaries to remove an anomaly in existing boundaries with respect to the location of existing buildings or structures.

Procedural Matters

Notification of Performance assessed development

Performance assessed development is excluded from notification except where it involves any of the following:

- (a) the site of the development is adjacent land to land in a different zone
- (b) any development that is identified (either partly or wholly) as 'All other Code Assessed Development' in Open Space Zone - Table 3.

Recreation Zone

Table 1 – Accepted Development Classification

Class of Development The following Classes of Development are classified as Accepted Development subject to meeting the 'Accepted Development Classification Criteria'	Accepted Development Classification Criteria
Building work on railway land	<ol style="list-style-type: none"> 1 Building work is associated with a railway 2 It is situated (or to be situated) on railway land 3 It is required for the conduct or maintenance of railway activities.
Carport Except where any of the following apply: <ul style="list-style-type: none"> • Character Preservation District Overlay • Coastal Areas Overlay • Hazards (Flooding) Overlay • Historic Area Overlay • Local Heritage Place Overlay • State Heritage Area Overlay • State Heritage Place Overlay • Native Vegetation Overlay • State Significant Native Vegetation Overlay • River Murray Flood Plain Overlay • Sloping Land Overlay • Future Road Widening Overlay where an existing access is altered or a new access is created • Key Railway Crossings Overlay where an existing access is altered or a new access is created • Key Outback and Rural Routes Overlay where an existing access 	<ol style="list-style-type: none"> 1 The development will not be built, or encroach, on an area that is, or will be, required for a sewerage system or waste control system 2 It is ancillary to a dwelling erected on the site 3 Primary street setback – at least 5.5m from the primary street boundary and as far back as the building line of the building to which it is ancillary 4 Secondary street setback – at least 900mm from the boundary of the allotment (if the land has boundaries on two or more roads) 5 Total floor area - does not exceed 40m² 6 Post height - does not exceed 3m measured from natural ground level (and not including a gable end) 7 Building height - does not exceed 5m 8 If situated on or abutting a boundary (not being a boundary with a primary street or secondary street) – a length not exceeding 10m unless: <ol style="list-style-type: none"> (a) a longer wall or structure exists on the adjacent site and is situated on the same allotment boundary; and (b) the proposed wall or structure will be built along the same length of boundary as the existing adjacent wall or structure to the same or lesser extent 9 If the carport abuts or is situated on the boundary of the allotment (not being a boundary with a primary street or secondary street):

<p>is altered or a new access is created</p> <ul style="list-style-type: none"> • Major Urban Transport Routes Overlay where an existing access is altered or a new access is created • Non-stop Corridor Overlay where an existing access is altered or a new access is created • Urban Transport Routes Overlay where an existing access is altered or a new access is created • Water Resources Overlay 	<ul style="list-style-type: none"> (a) it will not result in all relevant walls or structures located along the boundary exceeding 45% of the length of the boundary; and (b) it will not be located within 3m of any other wall along the same boundary unless on an adjacent site on that boundary there is an existing wall of a building that would be adjacent to or abut the proposed wall or structure <p>10 The total roofed area of all existing or proposed buildings on the allotment does not exceed 60% of the area of the allotment</p> <p>11 Door opening for vehicle access – does not exceed, in total, 7m in width or 50% of the width of the allotment frontage (whichever lesser)</p> <p>12 Internal dimensions – does not exceed 3.2m in width and 6m in length between all fences, walls and doors</p> <p>13 The carport:</p> <ul style="list-style-type: none"> (a) is located so that vehicle access: <ul style="list-style-type: none"> i. is provided via a lawfully existing or authorised driveway or access point or an access point for which consent has been granted as part of an application for the division of land; or ii. will use a driveway that: <ul style="list-style-type: none"> A. is not located within 6 metres of an intersection of 2 or more roads or a pedestrian actuated crossing; and B. will not interfere with an item of street furniture (including directional signs, lighting, seating and weather shelters), other infrastructure, or a tree; or iii. if adjacent a kerbed road, will be via a kerb that is designed to allow a vehicle to roll over it; and (b) is located so that the gradient from the place of access on the boundary of the allotment to the finished floor level at the front of the carport when the work is completed is not steeper than 1:4 on average; and (c) The centre of the driveway at the public road boundary is no more than 25 degree deviation from the centre of the front of the covered car parking space for which it provides vehicle access
<p>Demolition Except where any of the following apply:</p> <ul style="list-style-type: none"> • Historic Area Overlay 	<p>None.</p>

<ul style="list-style-type: none"> • A Local Heritage Place identified in the Local Heritage Place Overlay • State Heritage Area Overlay • A State Heritage Place identified in the State Heritage Place Overlay 	
<p>Internal building work Except where any of the following apply:</p> <ul style="list-style-type: none"> • A Local Heritage Place identified in the Local Heritage Place Overlay • State Heritage Area Overlay • A State Heritage Place identified in the State Heritage Place Overlay 	<ol style="list-style-type: none"> 1 There will be no increase in the total floor area of the building 2 There will be no alteration to the external appearance of the building.
<p>Outbuilding (in the form of a garage) Except where any of the following apply:</p> <ul style="list-style-type: none"> • Character Preservation District Overlay • Coastal Areas Overlay • Hazards (Flooding) Overlay • Historic Area Overlay • Local Heritage Place Overlay • State Heritage Area Overlay • State Heritage Place Overlay • Native Vegetation Overlay • State Significant Native Vegetation Overlay • River Murray Flood Plain Overlay • Sloping Land Overlay • Future Road Widening Overlay where an existing access is altered or a new access is created • Key Railway Crossings Overlay where an existing access is altered or a new access is created • Key Outback and Rural Routes Overlay where an existing access 	<ol style="list-style-type: none"> 1 The development will not be built, or encroach, on an area that is, or will be, required for a sewerage system or waste control system 2 It is detached from and ancillary to a dwelling erected on the site. 3 Primary street setback – at least 5.5m from the primary street boundary and as far back as the building line of the building to which it is ancillary 4 Secondary street setback – at least 900mm from the boundary of the allotment (if the land has boundaries on two or more roads) 5 Total floor area - does not exceed 40m² 6 Wall height - does not exceed 3m measured from natural ground level (and not including a gable end) 7 Building height - does not exceed 5m 8 If situated on or abutting a boundary (not being a boundary with a primary street or secondary street) – a length not exceeding 10m unless: <ol style="list-style-type: none"> (a) a longer wall or structure exists on the adjacent site and is situated on the same allotment boundary; and (b) the proposed wall or structure will be built along the same length of boundary as the existing adjacent wall or structure to the same or lesser extent 9 If the outbuilding abuts or is situated on the boundary of the allotment (not being a boundary with a primary street or secondary street): <ol style="list-style-type: none"> (a) it will not result in all relevant walls or structures located along the boundary exceeding 45% of the length of the boundary; and

<p>is altered or a new access is created</p> <ul style="list-style-type: none"> • Major Urban Transport Routes Overlay where an existing access is altered or a new access is created • Non-stop Corridor Overlay where an existing access is altered or a new access is created • Urban Transport Routes Overlay where an existing access is altered or a new access is created • Water Resources Overlay 	<p>(b) it will not be located within 3m of any other wall along the same boundary unless on an adjacent site on that boundary there is an existing wall of a building that would be adjacent to or abut the proposed wall or structure</p> <p>10 Total roofed area of all existing and proposed buildings on the allotment - does not exceed 60%</p> <p>11 Internal dimensions – exceed 3.2m in width and 6m in length between all walls and doors</p> <p>12 Door opening for vehicle access – does not exceed, in total, 7m in width or 50% of the width of the allotment frontage (whichever lesser)</p> <p>13 The garage:</p> <p>(a) is located so that vehicle access:</p> <ul style="list-style-type: none"> i. is provided via a lawfully existing or authorised driveway or access point or an access point for which consent has been granted as part of an application for the division of land; or ii. will use a driveway that: <ul style="list-style-type: none"> A. is not located within 6 metres of an intersection of 2 or more roads or a pedestrian actuated crossing; and B. will not interfere with an item of street furniture (including directional signs, lighting, seating and weather shelters), other infrastructure, or a tree; or iii. if adjacent a kerbed road, will be via a kerb that is designed to allow a vehicle to roll over it; and <p>(b) is located so that the gradient from the place of access on the boundary of the allotment to the finished floor level at the front of the carport when the work is completed is not steeper than 1:4 on average; and</p> <p>(c) The centre of the driveway at the public road boundary is no more than 25 degree deviation from the centre of the front of the covered car parking space for which it provides vehicle access</p> <p>14 If clad in sheet metal—is pre-colour treated or painted in a non-reflective colour.</p>
<p>Outbuilding (not being a garage) Except where any of the following apply:</p> <ul style="list-style-type: none"> • Character Preservation District Overlay • Coastal Areas Overlay • Hazards (Flooding) Overlay 	<p>37 The development will not be built, or encroach, on an area that is, or will be, required for a sewerage system or waste control system</p> <p>38 It is detached from and ancillary to a dwelling erected on the site</p> <p>39 Primary street setback – at least as far back as the building line of the building to which it is ancillary</p>

<ul style="list-style-type: none"> • Historic Area Overlay • Local Heritage Place Overlay • State Heritage Area Overlay • State Heritage Place Overlay • Native Vegetation Overlay • State Significant Native Vegetation Overlay • River Murray Flood Plain Overlay • Sloping Land Overlay • Water Resources Overlay 	<p>40 Secondary street setback – at least 900mm from the boundary of the allotment (if the land has boundaries on two or more roads)</p> <p>41 Side boundary setbacks – at least 900mm from the boundary of the allotment</p> <p>42 Total floor area does not exceed 40m²</p> <p>43 Wall height - does not exceed 3m measured from natural ground level (and not including a gable end)</p> <p>44 Building height - does not exceed 5m</p> <p>45 If situated on or abutting a boundary (not being a boundary with a primary street or secondary street) – a length not exceeding 10m unless:</p> <p style="padding-left: 20px;">(a) a longer wall or structure exists on the adjacent site and is situated on the same allotment boundary; and</p> <p style="padding-left: 20px;">(b) the proposed wall or structure will be built along the same length of boundary as the existing adjacent wall or structure to the same or lesser extent</p> <p>46 If the outbuilding abuts or is situated on the boundary of the allotment (not being a boundary with a primary street or secondary street):</p> <p style="padding-left: 20px;">(a) it will not result in all relevant walls or structures located along the boundary exceeding 45% of the length of the boundary; and</p> <p style="padding-left: 20px;">(b) will not be located within 3m of any other wall along the same boundary unless on an adjacent site on that boundary there is an existing wall of a building that would be adjacent to or abut the proposed wall or structure</p> <p>47 Total roofed area of all existing and proposed buildings on the allotment - does not exceed 60%</p> <p>48 If clad in sheet metal—is pre-colour treated or painted in a non-reflective colour.</p>
<p>Shade sail Except where any of the following apply:</p> <ul style="list-style-type: none"> • Character Preservation District Overlay • Coastal Areas Overlay • Historic Area Overlay • Local Heritage Place Overlay • State Heritage Area Overlay • State Heritage Place Overlay • Native Vegetation Overlay 	<p>22 The development will not be built, or encroach, on an area that is, or will be, required for a sewerage system or waste control system</p> <p>23 Shade sail consists of permeable material</p> <p>24 The total area of the sail - does not exceed 40m²</p> <p>25 No part of the shade sail will be:</p> <p style="padding-left: 20px;">(a) 3m above ground or floor level (depending on where it is situated) at any place within 900mm of a boundary of the allotment</p> <p style="padding-left: 20px;">(b) 5m above ground or floor level (depending on where it is situated) within any other part of the allotment</p>

<ul style="list-style-type: none"> • State Significant Native Vegetation Overlay • River Murray Flood Plain Overlay • Sloping Land Overlay • Water Resources Overlay 	<p>26 Primary street setback – at least as far back as the building line of the building to which it is ancillary</p> <p>27 If any part of the sail will be situated on a boundary of the allotment, the length of sail along a boundary does not exceed 8m</p> <p>28 In a case where any part of the sail or a supporting structure will be situated on a side boundary of the allotment — the length of the sail and any such supporting structure together with all relevant walls or structures located along the boundary will not exceed 45% of the length of the boundary.</p>
<p>Solar photovoltaic panels (roof mounted) Except where any of the following apply:</p> <ul style="list-style-type: none"> • Historic Area Overlay • A Local Heritage Place identified in the Local Heritage Place Overlay • State Heritage Area Overlay • A State Heritage Place identified in the State Heritage Place Overlay 	<p>13 Panels are installed parallel to the roof of a building and with the underside surface of the panel not being more than 100mm above the surface of the roof</p> <p>14 Panels and associated components do not overhang any part of the roof</p> <p>15 Does not apply to system with a generating capacity of more than 5MW that is to be connected to the State's power system.</p>
<p>Verandah Except where any of the following apply:</p> <ul style="list-style-type: none"> • Character Preservation District Overlay • Coastal Areas Overlay • Hazards (Flooding) Overlay • Historic Area Overlay • Local Heritage Place Overlay • State Heritage Area Overlay • State Heritage Place Overlay • Native Vegetation Overlay • State Significant Native Vegetation Overlay • River Murray Flood Plain Overlay • Water Resources Overlay 	<p>17 The development will not be built, or encroach, on an area that is, or will be, required for a sewerage system or waste control system</p> <p>18 It is ancillary to a dwelling erected on the site</p> <p>19 Primary street setback – as far back as the building line of the building to which it is ancillary</p> <p>20 Total floor area - does not exceed 40m²</p> <p>21 Post height - does not exceed 3m measured from natural ground level</p> <p>22 Building height - does not exceed 5m</p> <p>23 Length - does not exceed 10m if any part of the structure abuts or is situated on a boundary of the allotment</p> <p>24 Total roofed area of all existing and proposed buildings on the allotment - does not exceed 60%.</p>
<p>Water tank (above ground) Except where any of the following apply:</p>	<p>36 The development will not be built, or encroach, on an area that is, or will be, required for a sewerage system or waste control system</p> <p>37 The tank is part of a roof drainage system</p>

<ul style="list-style-type: none"> • Character Preservation District Overlay • Coastal Areas Overlay • Hazards (Flooding) Overlay • Historic Area Overlay • Local Heritage Place Overlay • State Heritage Area Overlay • State Heritage Place Overlay • Native Vegetation Overlay • State Significant Native Vegetation Overlay • River Murray Flood Plain Overlay • Sloping Land Overlay • Water Resources Overlay 	<p>38 Total floor area - not exceeding 15m²</p> <p>39 The tank is located wholly above ground</p> <p>40 Tank height – does not exceed 4m above natural ground level</p> <p>41 Primary street setback – at least as far back as the building line of the building to which it is ancillary</p> <p>42 In the case of a tank made of metal – the tank is pre-colour treated or painted in a non-reflective colour.</p>
<p>Water tank (underground) Except where any of the following apply:</p> <ul style="list-style-type: none"> • Character Preservation District Overlay • Coastal Areas Overlay • Native Vegetation Overlay • State Significant Native Vegetation Overlay • Sloping Land Overlay • Water Resources Overlay 	<p>11 The development will not be built, or encroach, on an area that is, or will be, required for a sewerage system or waste control system</p> <p>12 The tank (including any associated pump) is located wholly below the level of the ground.</p>

Table 2 – Deemed-to-Satisfy Development Classification

Class of Development The following Classes of Development are classified as Deemed-to-Satisfy Development subject to meeting the 'Deemed-to-Satisfy Development Classification Criteria'	Deemed-to-Satisfy Development Classification Criteria			
	Provisions referred to are Deemed-to-Satisfy Criteria Where a development comprises more than one Class of Development the relevant criteria will be taken to be the sum of the criteria for each Class of Development.			
	Zone	General Development Policies	Subzone (applies only in the area affected by the Subzone)	Overlay (applies only in the area affected by the Overlay)
<p>Advertisement</p> <p>Except where any of the following apply:</p> <ul style="list-style-type: none"> Advertising Near Signalised Intersections Overlay Character Preservation District Overlay Coastal Areas Overlay Hazards (Flooding) Overlay Historic Area Overlay Local Heritage Place Overlay Non-stop Corridor Overlay River Murray Flood Plain Overlay Sloping Land Overlay State Heritage Area Overlay State Heritage Place Overlay Water Resources Overlay 	None	<p>Clearance from Overhead Powerlines: DTS 1.1</p> <p>Advertisements [Appearance]: DTS 1.1, 1.3, 1.4</p> <p>Advertisements [Proliferation of Advertisements]: DTS 2.1, 2.2</p> <p>Advertisements [Advertising Content]: DTS 3.1</p> <p>Advertisements [Amenity Content]: DTS 4.1</p> <p>Advertising [Safety]: DTS 5.1, 5.2, 5.3, 5.4, 5.5</p>	None	<p>Advertising Near Signalised Intersections: DTS 1.1</p> <p>Airport Building Heights (Aircraft Landing Area): DTS 1.1</p> <p>Airport Building Heights (Regulated): DTS 1.1, 1.2</p> <p>Building Near Airfields: DTS 1.1</p> <p>Defence Aviation Area: DTS 1.1, 1.3</p> <p>Hazards (Acid Sulfate Soils): DTS 1.1</p> <p>Historic Shipwrecks: DTS 1.1</p> <p>Key Outback and Rural Route Overlay: DTS 8.1</p> <p>Major Transport Routes: DTS 8.1, DTS 10.1</p> <p>Native Vegetation: DTS 1.1, 1.2</p> <p>State Significant Native Vegetation: DTS 1.1</p> <p>Urban Transport Routes: DTS 8.1, 10.1</p>
<p>Outbuilding (not being a garage)</p> <p>Verandah</p> <p>Except where any of the following apply:</p> <ul style="list-style-type: none"> Character Preservation District Overlay Coastal Areas Overlay Hazards (Bushfire - General Risk) Overlay Hazards (Bushfire - High Risk) Overlay Hazards (Bushfire - Medium Risk) Overlay Hazards (Bushfire - Regional) Overlay Hazards (Flooding) Overlay Historic Area Overlay Local Heritage Place Overlay Marine Parks (Managed Use) Overlay Mt Lofty Ranges Catchment (Area 1) Overlay Mt Lofty Ranges Catchment (Area 2) Overlay River Murray Flood Plain Overlay Sloping Land Overlay 	[Built Form and Character]: DTS 2.1, 2.2	<p>Design in Urban Areas [All Residential Development – Ancillary Development]: DTS 17.1, 17.2</p> <p>Design in Urban Areas [Residential Development – 3 Building Levels or Less – External Appearance]: DTS 19.1</p>	None	<p>Airport Building Heights (Aircraft Landing Area): DTS 1.1</p> <p>Airport Building Heights (Regulated): DTS 1.1, 1.2</p> <p>Building Near Airfields: DTS 1.1, 1.2</p> <p>Defence Aviation Area: DTS 1.1, 1.3</p> <p>Historic Shipwrecks: DTS 1.1</p> <p>Key Outback and Rural Routes: DTS All</p> <p>Key Railway Crossings: DTS 1.1</p> <p>Major Transport Routes: DTS All</p> <p>Native Vegetation: DTS 1.1, 1.2</p> <p>State Significant Native Vegetation: DTS 1.1</p> <p>Urban Transport Routes: DTS All</p>

Class of Development The following Classes of Development are classified as Deemed-to-Satisfy Development subject to meeting the 'Deemed-to-Satisfy Development Classification Criteria'	Deemed-to-Satisfy Development Classification Criteria Provisions referred to are Deemed-to-Satisfy Criteria Where a development comprises more than one Class of Development the relevant criteria will be taken to be the sum of the criteria for each Class of Development.			
<ul style="list-style-type: none"> • State Heritage Place Overlay • Water Protection Area Overlay • Water Resources Overlay 	Zone	General Development Policies	Subzone (applies only in the area affected by the Subzone)	Overlay (applies only in the area affected by the Overlay)

Table 3 - Performance Assessed Development Assessment Table

Class of Development	Applicable Policies			
	Zone	General Development Policies	Subzone (applies only in the area affected by the Subzone)	Overlay (applies only in the area affected by the Overlay)
	<p>The following provisions are applicable to the assessment of the identified Class of Development.</p> <p>Provisions referred to are Performance Outcome policies, and any associated Designated Performance Features. Relevant Desired Outcomes are not listed, but automatically apply in relation to a Performance Assessed Development.</p> <p>Where a development comprises more than one Class of Development the relevant policies will be taken to be the sum of the applicable policies for each Class of Development.</p>			
Advertisement	None	<p>Clearance from Overhead Powerlines: PO 1.1</p> <p>Advertisements [Appearance]: PO 1.1, 1.3, 1.4</p> <p>Advertisements [Proliferation of Advertisements]: PO 2.1, 2.2</p> <p>Advertisements [Advertising Content]: PO 3.1</p> <p>Advertisements [Amenity Content]: PO 4.1</p> <p>Advertising [Safety]: PO 5.1, 5.2, 5.3, 5.4, 5.5</p>	None	<p>Advertising Near Signalised Intersections: All</p> <p>Airport Building Heights (Aircraft Landing Area): PO 1.1</p> <p>Airport Building Heights (Regulated): PO 1.1, 1.2</p> <p>Building Near Airfields: PO 1.1, 1.2</p> <p>Character Preservation District: All</p> <p>Coastal Areas: All</p> <p>Defence Aviation Area: PO 1.1, 1.3</p> <p>Hazards (Flooding): All</p> <p>Historic Area: All</p> <p>Key Outback and Rural Routes: PO 8.1, 10.1</p> <p>Key Railway Crossings: PO 1.1</p> <p>Local Heritage Place: All</p> <p>Major Transport Routes: PO 8.1, 10.1</p> <p>Marine Parks (Managed Use): All</p> <p>Mt Lofty Ranges Catchment (Area 1): All</p> <p>Mt Lofty Ranges Catchment (Area 2): All</p> <p>River Murray Flood Plain: All</p> <p>Sloping Land: All</p> <p>State Heritage Area: All</p> <p>State Heritage Place: All</p> <p>Native Vegetation: PO 1.1, 1.2</p> <p>State Significant Native Vegetation: PO 1.1</p> <p>Urban Transport Routes: PO 8.1, 10.1</p> <p>Water Resources: All</p>
Outbuilding (not being a garage) Verandah	[Built Form and Character]: PO 2.1, 2.2	<p>Clearance from Overhead Powerlines: PO 1.1</p> <p>Design in Urban Areas [All Residential Development – Ancillary Development]: PO 17.1, 17.2</p>	None	<p>Airport Building Heights (Aircraft Landing Area): PO 1.1</p> <p>Airport Building Heights (Regulated): PO 1.1, 1.2</p> <p>Building Near Airfields: PO 1.1, 1.2</p> <p>Character Preservation District: All</p> <p>Coastal Areas: All</p> <p>Hazards (Acid Sulfate Soils): All</p>

Class of Development	Applicable Policies			
	Zone	General Development Policies	Subzone (applies only in the area affected by the Subzone)	Overlay (applies only in the area affected by the Overlay)
				Hazards (Bushfire - High Risk): All Hazards (Bushfire - Medium Risk): All Hazards (Bushfire - General Risk): All Hazards (Bushfire - Urban Interface): All Hazards (Bushfire - Regional): All Hazards (Flooding): All Historic Area: All Key Outback and Rural Routes: PO 8.1, 10.1 Key Railway Crossings: All Local Heritage Place: All Major Transport Routes: PO 8.1, 10.1 Marine Parks (Managed Use): All Mt Lofty Ranges Catchment (Area 2): All Murray Darling Basin: All Native Vegetation: PO 1.1, 1.2 River Murray Flood Plain: All Sloping Land: All State Heritage Area: All State Heritage Place: All State Significant Native Vegetation: All Urban Transport Routes: PO 8.1, 10.1 Water Protection Area: All Water Resources: All
All other Code Assessed Development	All	All	None	Any Relevant Overlay: All

Table 4 – Restricted Development Classification

Class of Development
The following Classes of Development are classified as Restricted
None Specified

Assessment Provisions (AP)

Desired Outcome (DO)

DO 1

Provision of a range of accessible recreational facilities.

Performance Outcomes and Deemed to Satisfy / Designated Performance Outcome Criteria

Land Use and Intensity

PO 1.1

Development is associated with or ancillary to the provision of structured, unstructured, active and / or passive recreational facilities.

DTS/DPF 1.1

Development comprises one or more of the following land uses:

- Change rooms
- Golf course
- Indoor recreation facility
- Open space
- Outdoor sports courts
- Recreation area
- Sporting clubrooms
- Sporting ovals and fields

PO 1.2

Shops including restaurants are of a scale that is subordinate to the principal recreational use of land.

DTS/DPF 1.2

Shop gross leasable floor area does not exceed 80m².

PO 1.3

Offices are of a scale that is subordinate to the principal recreational use of land.

DTS/DPF 1.3

Office gross leasable floor area does not exceed 80m².

Built Form and Character

PO 2.1

Buildings designed and sited to manage visual impacts.

DTS/DPF 2.1

Buildings are set back:

- (a) 50m or greater from a primary street frontage; and
- (b) 50m from the boundary of an allotment containing, or zoned to primarily accommodate, a sensitive receiver in other ownership.

PO 2.2

Outbuildings of a scale that manages visual impacts.

DTS/DPF 2.2

Outbuildings have a:

- (a) floor area that does not exceed 80m²;
- (b) wall height that does not exceed 3m; and
- (c) building height that does not exceed 5m.

Land Division

PO 3.1

Land division supports the provision of recreational facilities

DTS/DPF 3.1

Land division is for the purposes of:

- (a) the creation of a public road or a public reserve; or
- (b) a minor adjustment of allotment boundaries to remove an anomaly in existing boundaries with respect to the location of existing buildings or structures.

Concept Plans

PO 4.1

Development is compatible with the outcomes sought by any relevant Concept Plan contained within the *Concept Plans Technical and Numeric Variation Overlay*.

DTS 4.1

None are applicable.

Procedural Matters (PM)

Notification of Performance assessed

Performance assessed development is excluded from notification except where it involves any of the following:

- (a) the development is located adjacent to the boundary of a zone that primarily intends to accommodate sensitive receivers; or
- (b) the development falls within the category of 'all other code assessed development' in Recreation Zone - Table 3.

Placement of Notices – Exemptions for Performance Assessed Development

None specified.

Placement of Notices – Exemptions for Restricted Development

None specified.

Remote Areas Zone

Table 1 – Accepted Development Classification

Class of Development The following Classes of Development are classified as Accepted Development subject to meeting the 'Accepted Development Classification Criteria'	Accepted Development Classification Criteria
Building work on railway land	11 Building work is associated with a railway 12 It is situated (or to be situated) on railway land 13 It is required for the conduct or maintenance of railway activities.
Carport Except where any of the following apply: <ul style="list-style-type: none"> • Coastal Areas Overlay • Historic Shipwrecks Overlay • State Heritage Area Overlay • State Heritage Place Overlay • Native Vegetation Overlay • State Significant Native Vegetation Overlay • Significant Landscape Protection Overlay • Ramsar Wetlands Overlay • River Murray Flood Plain Overlay • Sloping Land Overlay • Key Railway Crossings Overlay where an existing access is altered or a new access is created • Key Outback and Rural Routes Overlay where an existing access 	27 The development will not be built, or encroach, on an area that is, or will be, required for a sewerage system or waste control system 28 It is ancillary to a dwelling erected on the site 29 Primary street setback – at least 5.5m from the primary street boundary and as far back as the building line of the building to which it is ancillary 30 Secondary street setback – at least 900mm from the boundary of the allotment (if the land has boundaries on two or more roads) 31 Total floor area - does not exceed 60m ² 32 Post height - does not exceed 3m measured from natural ground level (and not including a gable end) 33 Building height - does not exceed 5m 34 If situated on or abutting a boundary (not being a boundary with a primary street or secondary street) – a length not exceeding 10m unless: <ul style="list-style-type: none"> (a) a longer wall or structure exists on the adjacent site and is situated on the same allotment boundary; and (b) the proposed wall or structure will be built along the same length of boundary as the existing adjacent wall or structure to the same or lesser extent

Class of Development The following Classes of Development are classified as Accepted Development subject to meeting the 'Accepted Development Classification Criteria'	Accepted Development Classification Criteria
<p>is altered or a new access is created</p> <ul style="list-style-type: none"> • Urban Transport Routes Overlay where an existing access is altered or a new access is created • Water Resources Overlay 	<p>35 If the carport abuts or is situated on the boundary of the allotment (not being a boundary with a primary street or secondary street):</p> <ul style="list-style-type: none"> (a) it will not result in all relevant walls or structures located along the boundary exceeding 45% of the length of the boundary; and (b) it will not be located within 3m of any other wall along the same boundary unless on an adjacent site on that boundary there is an existing wall of a building that would be adjacent to or abut the proposed wall or structure <p>36 Door opening for vehicle access – does not exceed, in total, 7m in width or 50% of the width of the allotment frontage (whichever lesser)</p> <p>37 Internal dimensions – does not exceed 3.2m in width and 6m in length between all fences, walls and doors</p> <p>38 The carport:</p> <ul style="list-style-type: none"> (a) is located so that vehicle access: <ul style="list-style-type: none"> i. is provided via a lawfully existing or authorised driveway or access point or an access point for which consent has been granted as part of an application for the division of land; or ii. will use a driveway that: <ul style="list-style-type: none"> A. is not located within 6 metres of an intersection of 2 or more roads or a pedestrian actuated crossing; and B. will not interfere with an item of street furniture (including directional signs, lighting, seating and weather shelters), other infrastructure, or a tree; or iii. if adjacent a kerbed road, will be via a kerb that is designed to allow a vehicle to roll over it; and (b) is located so that the gradient from the place of access on the boundary of the allotment to the finished floor level at the front of the carport when the work is completed is not steeper than 1:4 on average; and

Class of Development

The following Classes of Development are classified as Accepted Development subject to meeting the 'Accepted Development Classification Criteria'

Accepted Development Classification Criteria

39 The centre of the driveway at the public road boundary is no more than 25 degree deviation from the centre of the front of the covered car parking space for which it provides vehicle access

Internal building work

Except where any of the following apply:

- A Historic Shipwreck identified in the Historic Shipwrecks Overlay
- State Heritage Area Overlay
- A State Heritage Place identified in the State Heritage Place Overlay

- 3 There will be no increase in the total floor area of the building
- 4 There will be no alteration to the external appearance of the building.

Outbuilding (in the form of a Garage)

Except where any of the following apply:

- Coastal Areas Overlay
- Historic Shipwrecks Overlay
- State Heritage Area Overlay
- State Heritage Place Overlay
- Native Vegetation Overlay
- State Significant Native Vegetation Overlay
- Significant Landscape Protection Overlay
- Ramsar Wetlands Overlay

- 1 The development will not be built, or encroach, on an area that is, or will be, required for a sewerage system or waste control system
- 2 It is detached from and ancillary to a dwelling erected on the site.
- 3 Primary street setback – at least 5.5m from the primary street boundary and as far back as the building line of the building to which it is ancillary
- 4 Secondary street setback – at least 900mm from the boundary of the allotment (if the land has boundaries on two or more roads)
- 5 Total floor area - does not exceed 60m²
- 6 Wall height - does not exceed 3m measured from natural ground level (and not including a gable end)
- 7 Building height - does not exceed 5m
- 8 If situated on or abutting a boundary (not being a boundary with a primary street or secondary street) – a length not exceeding 10m unless:

Class of Development

The following Classes of Development are classified as Accepted Development subject to meeting the 'Accepted Development Classification Criteria'

- River Murray Flood Plain Overlay
- Sloping Land Overlay
- Key Railway Crossings Overlay where an existing access is altered or a new access is created
- Key Outback and Rural Routes Overlay where an existing access is altered or a new access is created
- Urban Transport Routes Overlay where an existing access is altered or a new access is created
- Water Resources Overlay

Accepted Development Classification Criteria

- (a) a longer wall or structure exists on the adjacent site and is situated on the same allotment boundary; and
 - (b) the proposed wall or structure will be built along the same length of boundary as the existing adjacent wall or structure to the same or lesser extent
- 9 If the outbuilding abuts or is situated on the boundary of the allotment (not being a boundary with a primary street or secondary street):
- (a) it will not result in all relevant walls or structures located along the boundary exceeding 45% of the length of the boundary; and
 - (b) it will not be located within 3m of any other wall along the same boundary unless on an adjacent site on that boundary there is an existing wall of a building that would be adjacent to or abut the proposed wall or structure
- 10 Internal dimensions – exceed 3.2m in width and 6m in length between all walls and doors
- 11 Door opening for vehicle access – does not exceed, in total, 7m in width or 50% of the width of the allotment frontage (whichever lesser)
- 12 The garage:
- o is located so that vehicle access:
 - i. is provided via a lawfully existing or authorised driveway or access point or an access point for which consent has been granted as part of an application for the division of land; or
 - ii. will use a driveway that:
 - A. is not located within 6 metres of an intersection of 2 or more roads or a pedestrian actuated crossing; and
 - B. will not interfere with an item of street furniture (including directional signs, lighting, seating and weather shelters), other infrastructure, or a tree; or
 - iii. if adjacent a kerbed road, will be via a kerb that is designed to allow a vehicle to roll over it; and

Class of Development

The following Classes of Development are classified as Accepted Development subject to meeting the 'Accepted Development Classification Criteria'

Accepted Development Classification Criteria

- o is located so that the gradient from the place of access on the boundary of the allotment to the finished floor level at the front of the carport when the work is completed is not steeper than 1:4 on average; and
- o The centre of the driveway at the public road boundary is no more than 25 degree deviation from the centre of the front of the covered car parking space for which it provides vehicle access

13 If clad in sheet metal—is pre-colour treated or painted in a non-reflective colour.

Outbuilding (not being a garage)

Except where any of the following apply:

- Coastal Areas Overlay
- Historic Shipwrecks Overlay
- State Heritage Area Overlay
- State Heritage Place Overlay
- Native Vegetation Overlay
- State Significant Native Vegetation Overlay
- Significant Landscape Protection Overlay
- Ramsar Wetlands Overlay
- River Murray Flood Plain Overlay
- Sloping Land Overlay
- Water Resources Overlay

- 1 The development will not be built, or encroach, on an area that is, or will be, required for a sewerage system or waste control system
- 2 It is detached from and ancillary to a dwelling erected on the site
- 3 Primary street setback – at least as far back as the building line of the building to which it is ancillary
- 4 Secondary street setback – at least 900mm from the boundary of the allotment (if the land has boundaries on two or more roads)
- 5 Side boundary setbacks – at least 900mm from the boundary of the allotment
- 6 Total floor area does not exceed 60m²
- 7 Wall height - does not exceed 3m measured from natural ground level (and not including a gable end)
- 8 Building height - does not exceed 5m
- 9 If situated on or abutting a boundary (not being a boundary with a primary street or secondary street) – a length not exceeding 10m unless:
 - (a) a longer wall or structure exists on the adjacent site and is situated on the same allotment boundary; and
 - (b) the proposed wall or structure will be built along the same length of boundary as the existing adjacent wall or structure to the same or lesser extent

Class of Development

The following Classes of Development are classified as Accepted Development subject to meeting the 'Accepted Development Classification Criteria'

Accepted Development Classification Criteria

- 10 If the outbuilding abuts or is situated on the boundary of the allotment (not being a boundary with a primary street or secondary street):
 - (a) it will not result in all relevant walls or structures located along the boundary exceeding 45% of the length of the boundary; and
 - (b) will not be located within 3m of any other wall along the same boundary unless on an adjacent site on that boundary there is an existing wall of a building that would be adjacent to or abut the proposed wall or structure
- 13 If clad in sheet metal—is pre-colour treated or painted in a non-reflective colour.

Private bushfire shelters

Except where any of the following apply:

- Coastal Areas Overlay
- Historic Shipwrecks Overlay
- State Heritage Area Overlay
- State Heritage Place Overlay
- Native Vegetation Overlay
- State Significant Native Vegetation Overlay
- Significant Landscape Protection Overlay
- Ramsar Wetlands Overlay
- River Murray Flood Plain Overlay
- Sloping Land Overlay
- Water Resources Overlay

- 14 The development will not be built, or encroach, on an area that is, or will be, required for a sewerage system or waste control system
- 15 Primary street setback – at least as far back as the building to which it is ancillary
- 16 Secondary street setback – at least 900mm from the boundary of the allotment
- 17 At least 6m from the corner of an allotment which abuts the intersection of two or more roads (other than where a 4m x 4m allotment cut-off is already in place).

Protective tree netting structure

- 15 development will not be built, or encroach, on an area that is, or will be, required for a sewerage system or waste control system

Class of Development The following Classes of Development are classified as Accepted Development subject to meeting the 'Accepted Development Classification Criteria'	Accepted Development Classification Criteria
<p>Except where any of the following apply:</p> <ul style="list-style-type: none"> • Coastal Areas Overlay • State Heritage Area Overlay • State Heritage Place Overlay • State Significant Native Vegetation Overlay • Significant Landscape Protection Overlay • Ramsar Wetlands Overlay • River Murray Flood Plain Overlay • Sloping Land Overlay • Water Protection Area Overlay • Water Resources Overlay 	<p>16 No part of the protective tree netting structure will be more than 6m above natural ground level (depending on where it is situated)</p> <p>17 Netting visible from the outside of the protective tree netting structure is of a low light-reflective nature, and, in the case of a structure that has side netting, the side netting is of a dark colour</p> <p>18 In the case of a development on a site that is within a Hazards (Bushfire - Outback) Overlay, Hazards (Bushfire – Regional) Overlay, Hazards (Bushfire - General Risk) Overlay, Hazards (Bushfire Medium - Risk) Overlay or Hazards (Bushfire - High Risk) Overlay, the protective tree netting structure provides for access to the site in accordance with the following:</p> <ul style="list-style-type: none"> (e) no part of the protective tree netting structure (including cables and points of attachment of cables (known as "auger" or "anchor" points) will be within 5m of any boundary of the site; or (f) does not prevent access or movement of vehicles of 4m height and 3.5m width (or less) on any access road or track (including fire tracks) on the site <p>19 No part of the netting canopy of the protective tree netting structure:</p> <ul style="list-style-type: none"> (e) will cover native vegetation; or (f) will be within 5m of a road (including any road reserve) <p>20 The points of attachment of any cables will not be located:</p> <ul style="list-style-type: none"> (e) outside the boundaries of the site; or (f) within a watercourse (within the meaning of the Natural Resources Management Act 2004) <p>21 In relation to a dwelling located on an allotment adjoining the site on which the protective tree netting structure is located, the protective tree netting structure complies with the following:</p> <ul style="list-style-type: none"> (e) if the netting canopy nearest the dwelling on the adjoining allotment is 4m or less above ground level (depending on where it is situated), no part of the netting canopy is within 10m of the dwelling

Class of Development

The following Classes of Development are classified as Accepted Development subject to meeting the 'Accepted Development Classification Criteria'

Accepted Development Classification Criteria

(f) in any other case, no part of the netting canopy is within 15m of the dwelling.

Shade sail

Except where any of the following apply:

- Coastal Areas Overlay
- Historic Shipwrecks Overlay
- State Heritage Area Overlay
- State Heritage Place Overlay
- Native Vegetation Overlay
- State Significant Native Vegetation Overlay
- Significant Landscape Protection Overlay
- Ramsar Wetlands Overlay
- River Murray Flood Plain Overlay
- Sloping Land Overlay
- Water Resources Overlay

29 The development will not be built, or encroach, on an area that is, or will be, required for a sewerage system or waste control system

30 Shade sail consists of permeable material

31 The total area of the sail - does not exceed 40m²

32 No part of the shade sail will be:

(a) 3m above ground or floor level (depending on where it is situated) at any place within 900mm of a boundary of the allotment

(b) 5m above ground or floor level (depending on where it is situated) within any other part of the allotment

33 Primary street setback – at least as far back as the building line of the building to which it is ancillary

34 If any part of the sail will be situated on a boundary of the allotment, the length of sail along a boundary does not exceed 8m

35 In a case where any part of the sail or a supporting structure will be situated on a side boundary of the allotment — the length of the sail and any such supporting structure together with all relevant walls or structures located along the boundary will not exceed 45% of the length of the boundary.

Solar photovoltaic panels (roof mounted)

16 Panels are installed parallel to the roof of a building and with the underside surface of the panel not being more than 100mm above the surface of the roof

17 Panels and associated components do not overhang any part of the roof

Class of Development

The following Classes of Development are classified as Accepted Development subject to meeting the 'Accepted Development Classification Criteria'

Accepted Development Classification Criteria

Except where any of the following apply:

- State Heritage Area Overlay
- A State Heritage Place identified in the State Heritage Place Overlay

18 Does not apply to system with a generating capacity of more than 5MW that is to be connected to the State's power system.

Solar photovoltaic panels (ground mounted)

- Coastal Areas Overlay
- Hazards (Acid Sulfate Soils) Overlay
- River Murray Flood Plain Overlay
- Significant Landscape Protection Overlay
- State Significant Native Vegetation Overlay
- RAMSAR Wetlands Overlay
- State Heritage Area Overlay
- A State Heritage Place identified in the State Heritage Place Overlay

- 1 The system is freestanding rather than attached to a building or other structure.
- 2 No part of the system:
 - (a) is more than 4 metres in height (measured as a height above the natural surface of the ground);
 - (b) is within 100 metres of a dwelling not associated with the system (whether the dwelling is on the same allotment as the system or another allotment); and
 - (c) is within 10 metres of a boundary of an allotment containing a dwelling not associated with the system.
- 3 The generating capacity of the system does not exceed 30 kW.
- 4 Does not result in the clearance of any native vegetation

Spa pool

Swimming pool

Except where any of the following apply:

- Coastal Areas Overlay
- Hazards (Flooding) Overlay

- 21 The development will not be built, or encroach, on an area that is, or will be, required for a sewerage system or waste control system
- 22 It is ancillary to a dwelling erected on the site
- 23 Allotment boundary setback – not less than 1m
- 24 Primary street setback – at least as far back as the building line of the building to which it is ancillary
- 25 Location of filtration system from a dwelling on an adjoining allotment:

Class of Development

The following Classes of Development are classified as Accepted Development subject to meeting the 'Accepted Development Classification Criteria'

Accepted Development Classification Criteria

- Historic Shipwrecks Overlay
- State Heritage Area Overlay
- State Heritage Place Overlay
- Native Vegetation Overlay
- State Significant Native Vegetation Overlay
- Significant Landscape Protection Overlay
- Ramsar Wetlands Overlay
- River Murray Flood Plain Overlay
- Sloping Land Overlay
- Water Resources Overlay

- (a) not less than 5m where the filtration system is located inside a solid structure that will have material impact on the transmission of noise
- (b) not less than 12m in any other case.

Verandah

Except where any of the following apply:

Except where any of the following apply:

- TBC

- 25 The development will not be built, or encroach, on an area that is, or will be, required for a sewerage system or waste control system
- 26 It is ancillary to a dwelling erected on the site
- 27 Primary street setback – as far back as the building line of the building to which it is ancillary
- 28 Total floor area - does not exceed 60m²
- 29 Post height - does not exceed 3m measured from natural ground level
- 30 Building height - does not exceed 5m
- 31 Length - does not exceed 10m if any part of the structure abuts or is situated on a boundary of the allotment

Water tank (underground)

- 13 The development will not be built, or encroach, on an area that is, or will be, required for a sewerage system or waste control system
- 14 The tank (including any associated pump) is located wholly below the level of the ground.

Class of Development

The following Classes of Development are classified as Accepted Development subject to meeting the 'Accepted Development Classification Criteria'

Accepted Development Classification Criteria

Except where any of the following apply:

- Coastal Areas Overlay
- Hazards (Acid Sulfate soils) Overlay
- Historic Shipwrecks Overlay
- Native Vegetation Overlay
- State Significant Native Vegetation Overlay
- Ramsar Wetlands Overlay
- Sloping Land Overlay
- Water Resources Overlay.

Any of the following where it is located within the boundary of a mining settlement associated with an approved mining lease that has been granted final development approval:

- Accommodation units
- Building or building work
- Bus terminal
- Car parking area
- Commercial development
- Community facility
- Industry
- Infrastructure
- Office

None

Class of Development The following Classes of Development are classified as Accepted Development subject to meeting the 'Accepted Development Classification Criteria'	Accepted Development Classification Criteria			
<ul style="list-style-type: none"> • Recreation facilities • Shop or group of shops • Site works • Tavern / club • Warehouse 				

Table 2 – Deemed-to-Satisfy Development Classification

Class of Development The following Classes of Development are classified as Deemed-to-Satisfy Development subject to meeting the 'Deemed-to-Satisfy Development Classification Criteria'	Deemed-to-Satisfy Development Classification Criteria Provisions referred to are Deemed-to-Satisfy Criteria Where a development comprises more than one Class of Development the relevant criteria will be taken to be the sum of the criteria for each Class of Development.			
	Zone	General Development Policies	Subzone (applies only in the area affected by the Subzone)	Overlay (applies only in the area affected by the Overlay)
Advertisement Except where any of the following apply: <ul style="list-style-type: none"> • Coastal Areas Overlay • Hazards (Flooding) Overlay 	None	Advertisements [Appearance]: DTS 1.1, 1.3, 1.4 Advertisements [Proliferation of Advertisements]: DTS 2.1, 2.2	None	Airport Building Heights (Aircraft Landing Area): DTS 1.1, 1.2 Building Near Airfields: DTS 1.1 Hazards (Acid Sulfate Soils): DTS 1.1 Historic Shipwrecks: DTS 1.1

Class of Development

The following Classes of Development are classified as Deemed-to-Satisfy Development subject to meeting the 'Deemed-to-Satisfy Development Classification Criteria'

Deemed-to-Satisfy Development Classification Criteria

Provisions referred to are Deemed-to-Satisfy Criteria
Where a development comprises more than one Class of Development the relevant criteria will be taken to be the sum of the criteria for each Class of Development.

Zone	General Development Policies	Subzone (applies only in the area affected by the Subzone)	Overlay (applies only in the area affected by the Overlay)
-------------	-------------------------------------	--	--

- Local Heritage Place Overlay
- Marine Parks (Managed Use) Overlay
- Marine Parks (Restricted Use) Overlay
- Murray Darling Basin Overlay
- Ramsar Wetlands Overlay
- River Murray Flood Plain Overlay
- Significant Landscape Protection Overlay
- Sloping Land Overlay
- State Heritage Area Overlay
- State Heritage Place Overlay
- Water Protection Area Overlay

Advertisements [Advertising Content]: DTS 3.1
Advertisements [Amenity Content]: DTS 4.1
Advertising [Safety]: DTS 5.1, 5.2, 5.3, 5.4, 5.5
Clearance from Overhead Powerlines: DTS 1.1

Key Outback and Rural Routes: DTS 8.1, 10.1
Key Railway Crossings; DTS 1.1
Native Vegetation: DTS1.1, 1.2
State Significant Native Vegetation: DTS 1.1
Urban Transport Routes: DTS 8.1, 10.1

Class of Development

The following Classes of Development are classified as Deemed-to-Satisfy Development subject to meeting the 'Deemed-to-Satisfy Development Classification Criteria'

Deemed-to-Satisfy Development Classification Criteria

Provisions referred to are Deemed-to-Satisfy Criteria
Where a development comprises more than one Class of Development the relevant criteria will be taken to be the sum of the criteria for each Class of Development.

	Zone	General Development Policies	Subzone (applies only in the area affected by the Subzone)	Overlay (applies only in the area affected by the Overlay)
<ul style="list-style-type: none"> Water Resources Overlay 				
<p>Carport Outbuilding (in the form of a garage) Except where any of the following apply:</p> <ul style="list-style-type: none"> Coastal Areas Overlay Hazards (Bushfire - General Risk) Overlay Hazards (Bushfire - Medium Risk) Overlay Hazards (Bushfire - Outback) Overlay Hazards (Bushfire - Regional) Overlay Hazards (Flooding) Overlay Local Heritage Place Overlay 	None	<p>Design in Rural Areas [All Residential Development – Ancillary Development]: DTS 13.1, 13.2</p> <p>Infrastructure and Renewable Energy Facilities [Wastewater Services]: DTS 12.2</p> <p>Transport, Access and Parking [Vehicle Access]: DTS 3.1, 3.5</p>	None	<p>Airport Building Heights (Aircraft Landing Area): DTS 1.1, 1.2</p> <p>Building Near Airfields: DTS 1.1</p> <p>Hazards (Acid Sulfate Soils): DTS 1.1</p> <p>Historic Shipwrecks: DTS 1.1</p> <p>Key Outback and Rural Routes: All</p> <p>Key Railway Crossings: DTS 1.1</p> <p>Native Vegetation: DTS 1.1, 1.2</p> <p>State Significant Native Vegetation: DTS 1.1</p> <p>Urban Transport Routes: All</p>

Class of Development

The following Classes of Development are classified as Deemed-to-Satisfy Development subject to meeting the 'Deemed-to-Satisfy Development Classification Criteria'

Deemed-to-Satisfy Development Classification Criteria

Provisions referred to are Deemed-to-Satisfy Criteria
Where a development comprises more than one Class of Development the relevant criteria will be taken to be the sum of the criteria for each Class of Development.

Zone

General Development Policies

Subzone

(applies only in the area affected by the Subzone)

Overlay

(applies only in the area affected by the Overlay)

- Marine Parks (Managed Use) Overlay
- Marine Parks (Restricted Use) Overlay
- Murray Darling Basin Overlay
- Ramsar Wetlands Overlay
- River Murray Flood Plain Overlay
- Significant Landscape Protection Overlay
- Sloping Land Overlay
- State Heritage Area Overlay
- State Heritage Place Overlay
- Water Protection Area Overlay
- Water Resources Overlay

Class of Development

The following Classes of Development are classified as Deemed-to-Satisfy Development subject to meeting the 'Deemed-to-Satisfy Development Classification Criteria'

Deemed-to-Satisfy Development Classification Criteria

Provisions referred to are Deemed-to-Satisfy Criteria
Where a development comprises more than one Class of Development the relevant criteria will be taken to be the sum of the criteria for each Class of Development.

Zone

General Development Policies

Subzone

(applies only in the area affected by the Subzone)

Overlay

(applies only in the area affected by the Overlay)

Detached dwelling

- Except where any of the following apply:
- Coastal Areas Overlay
 - Hazards (Bushfire - General Risk) Overlay
 - Hazards (Bushfire - Medium Risk) Overlay
 - Hazards (Bushfire - Regional) Overlay
 - Hazards (Flooding) Overlay
 - Local Heritage Place Overlay
 - Marine Parks (Managed Use) Overlay
 - Marine Parks (Restricted Use) Overlay

[Built Form and Character]: DTS 2.2

- Clearance from Overhead Powerlines: DTS 1.1
- Design in Rural Areas [All Development - On-site Waste Treatment Systems]: DTS 6.1
- Infrastructure and Renewable Energy Facilities [Water Supply]: DTS 11.2
- Infrastructure and Renewable Energy Facilities [Wastewater Services]: DTS 12.1, 12.2
- Interface Between Land Uses [Interface with Mines and Quarries (Rural and Remote Areas): DTS 10.1
- Site Contamination: DTS 1.1
- Transport, Access and Parking [Vehicle Access]: DTS 3.1, 3.5, 3.6

None

- Airport Building Heights (Aircraft Landing Area): DTS 1.1, 1.2
- Building Near Airfields: DTS 1.1
- Hazards (Acid Sulfate Soils): DTS 1.1
- Hazards (Bushfire - Outback): All
- Historic Shipwrecks: DTS 1.1
- Key Outback and Rural Routes: All
- Key Railway Crossings: DTS 1.1
- Native Vegetation: DTS 1.1, 1.2
- State Significant Native Vegetation: DTS 1.1
- Strategic Infrastructure Gas Pipelines: DTS 1.2
- Urban Transport Routes: All

Class of Development

The following Classes of Development are classified as Deemed-to-Satisfy Development subject to meeting the 'Deemed-to-Satisfy Development Classification Criteria'

Deemed-to-Satisfy Development Classification Criteria

Provisions referred to are Deemed-to-Satisfy Criteria
Where a development comprises more than one Class of Development the relevant criteria will be taken to be the sum of the criteria for each Class of Development.

Zone

General Development Policies

Subzone

(applies only in the area affected by the Subzone)

Overlay

(applies only in the area affected by the Overlay)

- Murray Darling Basin Overlay
- Prescribed Watercourses Overlay
- Prescribed Wells Area Overlay
- Ramsar Wetlands Overlay
- Resource Extraction Protection Area Overlay
- River Murray Flood Plain Overlay
- Significant Landscape Protection Overlay
- Sloping Land Overlay
- State Heritage Area Overlay
- State Heritage Place Overlay
- Water Protection Area Overlay

Class of Development The following Classes of Development are classified as Deemed-to-Satisfy Development subject to meeting the 'Deemed-to-Satisfy Development Classification Criteria'	Deemed-to-Satisfy Development Classification Criteria Provisions referred to are Deemed-to-Satisfy Criteria Where a development comprises more than one Class of Development the relevant criteria will be taken to be the sum of the criteria for each Class of Development.			
	Zone	General Development Policies	Subzone (applies only in the area affected by the Subzone)	Overlay (applies only in the area affected by the Overlay)
<ul style="list-style-type: none"> Water Resources Overlay 				
Dwelling addition Except where any of the following apply: <ul style="list-style-type: none"> Coastal Areas Overlay Hazards (Bushfire - General Risk) Overlay Hazards (Bushfire - Medium Risk) Overlay Hazards (Bushfire - Regional) Overlay Hazards (Flooding) Overlay Local Heritage Place Overlay Marine Parks (Managed Use) Overlay Marine Parks (Restricted Use) Overlay 	[Built Form and Character]: DTS 2.2	Clearance from Overhead Powerlines: DTS 1.1 Design in Rural Areas [All Development - On-site Waste Treatment Systems]: DTS 6.1	None	Airport Building Heights (Aircraft Landing Area): DTS 1.1, 1.2 Building Near Airfields: DTS 1.1 Hazards (Acid Sulfate Soils): DTS 1.1 Hazards (Bushfire - Outback): All Historic Shipwrecks: DTS 1.1 Native Vegetation: DTS1.1, 1.2 State Significant Native Vegetation: DTS 1.1 Strategic Infrastructure Gas Pipelines: DTS 1.2

Class of Development

The following Classes of Development are classified as Deemed-to-Satisfy Development subject to meeting the 'Deemed-to-Satisfy Development Classification Criteria'

Deemed-to-Satisfy Development Classification Criteria

Provisions referred to are Deemed-to-Satisfy Criteria
Where a development comprises more than one Class of Development the relevant criteria will be taken to be the sum of the criteria for each Class of Development.

Zone

General Development Policies

Subzone

(applies only in the area affected by the Subzone)

Overlay

(applies only in the area affected by the Overlay)

- Murray Darling Basin Overlay
- Prescribed Watercourses Overlay
- Prescribed Wells Area Overlay
- Ramsar Wetlands Overlay
- Resource Extraction Protection Area Overlay
- River Murray Flood Plain Overlay
- Significant Landscape Protection Overlay
- Sloping Land Overlay
- State Heritage Area Overlay
- State Heritage Place Overlay
- Water Protection Area Overlay

Class of Development

The following Classes of Development are classified as Deemed-to-Satisfy Development subject to meeting the 'Deemed-to-Satisfy Development Classification Criteria'

Deemed-to-Satisfy Development Classification Criteria

Provisions referred to are Deemed-to-Satisfy Criteria
Where a development comprises more than one Class of Development the relevant criteria will be taken to be the sum of the criteria for each Class of Development.

- Water Resources Overlay

Zone

General Development Policies

Subzone

(applies only in the area affected by the Subzone)

Overlay

(applies only in the area affected by the Overlay)

None

None

None

None

Essential infrastructure where it is required to service development within the Local Infrastructure (Airfield) Zone located on the Andamooka Road (11km east of the eastern most boundary of Roxby Downs [Municipality]) and / or the site of Olympic Dam mining settlement (as per the approved Olympic Dam mining lease) provided it is sited within 150m north, and 50m south, of the existing road alignment of Andamooka Road, between the eastern boundary of the Roxby Downs (Municipality) and the eastern zone

Class of Development

The following Classes of Development are classified as Deemed-to-Satisfy Development subject to meeting the 'Deemed-to-Satisfy Development Classification Criteria'

Deemed-to-Satisfy Development Classification Criteria

Provisions referred to are Deemed-to-Satisfy Criteria
Where a development comprises more than one Class of Development the relevant criteria will be taken to be the sum of the criteria for each Class of Development.

Zone	General Development Policies	Subzone (applies only in the area affected by the Subzone)	Overlay (applies only in the area affected by the Overlay)
-------------	-------------------------------------	--	--

boundary of the Local Infrastructure (Airfield) Zone.				
---	--	--	--	--

<p>Excavation and filling Except where any of the following apply:</p> <ul style="list-style-type: none"> • Coastal Areas Overlay • Ramsar Wetlands Overlay • River Murray Flood Plain Overlay • Significant Landscape Protection Overlay • State Heritage Area Overlay • State Heritage Place Overlay • Water Resources Overlay. 	None	Design in Rural Areas [Earthworks]: DTS 8.1	None	Hazards (Acid Sulfate Soils): DTS 1.1. Historic Shipwrecks: DTS 1.1
---	------	---	------	--

Class of Development The following Classes of Development are classified as Deemed-to-Satisfy Development subject to meeting the 'Deemed-to-Satisfy Development Classification Criteria'	Deemed-to-Satisfy Development Classification Criteria Provisions referred to are Deemed-to-Satisfy Criteria Where a development comprises more than one Class of Development the relevant criteria will be taken to be the sum of the criteria for each Class of Development.			
	Zone	General Development Policies	Subzone (applies only in the area affected by the Subzone)	Overlay (applies only in the area affected by the Overlay)
Outbuilding (not being a garage) Verandah Except where any of the following apply: <ul style="list-style-type: none"> • Coastal Areas Overlay • Hazards (Bushfire - General Risk) Overlay • Hazards (Bushfire - Medium Risk) Overlay • Hazards (Bushfire - Outback) Overlay • Hazards (Bushfire - Regional) Overlay • Hazards (Flooding) Overlay • Local Heritage Place Overlay • Marine Parks (Managed Use) Overlay • Marine Parks (Restricted Use) Overlay 	None	Design in Rural Areas [All Residential Development – Ancillary Development]: DTS 13.1, 13.2 Infrastructure and Renewable Energy Facilities [Wastewater Services]: DTS 12.2	None	Airport Building Heights (Aircraft Landing Area): DTS 1.1, 1.2 Building Near Airfields: DTS 1.1 Hazards (Acid Sulfate Soils): DTS 1.1 Historic Shipwrecks: DTS 1.1 Native Vegetation: DTS1.1, 1.2 State Significant Native Vegetation: DTS 1.1

Class of Development

The following Classes of Development are classified as Deemed-to-Satisfy Development subject to meeting the 'Deemed-to-Satisfy Development Classification Criteria'

Deemed-to-Satisfy Development Classification Criteria

Provisions referred to are Deemed-to-Satisfy Criteria
Where a development comprises more than one Class of Development the relevant criteria will be taken to be the sum of the criteria for each Class of Development.

Zone

General Development Policies

Subzone

(applies only in the area affected by the Subzone)

Overlay

(applies only in the area affected by the Overlay)

- Murray Darling Basin Overlay
- Ramsar Wetlands Overlay
- River Murray Flood Plain Overlay
- Significant Landscape Protection Overlay
- Sloping Land Overlay
- State Heritage Area Overlay
- State Heritage Place Overlay
- Water Protection Area Overlay
- Water Resources Overlay

Table 3 – Applicable Policies for Performance Assessed Development

Class of Development	Applicable Policies			
	Zone	General Development Policies	Subzone (applies only in the area affected by the Subzone)	Overlay (applies only in the area affected by the Overlay)
Advertisement	None	Advertisements [Appearance]: PO 1.1, 1.3, 1.4 Advertisements [Proliferation of Advertisements]: PO 2.1, 2.2 Advertisements [Advertising Content]: PO 3.1 Advertisements [Amenity Content]: PO 4.1 Advertising [Safety]: PO 5.1, 5.2, 5.3, 5.4, 5.5 Clearance from Overhead Powerlines: PO 1.1	None	Airport Building Heights (Aircraft Landing Area): PO 1.1, 1.2 Building Near Airfields: PO 1.1 Coastal Areas: All Hazards (Acid Sulfate Soils): PO 1.1 Hazards (Flooding): All Historic Shipwrecks: PO 1.1 Key Outback and Rural Routes: PO 8.1, 10.1 Key Railway Crossings: PO 1.1 Local Heritage Place: All Marine Parks (Managed Use): All Marine Parks (Restricted Use): All Murray Darling Basin: All

Class of Development	Applicable Policies			
	Zone	General Development Policies	Subzone (applies only in the area affected by the Subzone)	Overlay (applies only in the area affected by the Overlay)
				<p>Native Vegetation: PO 1.1, 1.2</p> <p>Ramsar Wetlands: All</p> <p>River Murray Flood Plain: All</p> <p>Significant Landscape Protection: All</p> <p>Sloping Land: All</p> <p>State Heritage Area: All</p> <p>State Heritage Place: All</p> <p>State Significant Native Vegetation: PO 1.1</p> <p>Urban Transport Routes: PO 8.1, 10.1</p> <p>Water Protection Area: All</p> <p>Water Resources: All</p>

The following policies are applicable to the assessment of the identified Class of Development. Policies referred to are Performance Outcome policies, and any associated Designated Performance Features. Relevant Desired Outcomes are not listed, but automatically apply in relation to a Performance Assessed Development.

Where a development comprises more than one Class of Development the relevant policies will be taken to be the sum of the applicable policies for each Class of Development.

Class of Development	Applicable Policies			
	Zone	General Development Policies	Subzone (applies only in the area affected by the Subzone)	Overlay (applies only in the area affected by the Overlay)
Agricultural building	[Land Use and Intensity]: PO 1.1 [Built Form and Character]: PO 2.1, 2.2	Clearance from Overhead Powerlines: PO 1.1 Infrastructure and Renewable Energy Facilities [Wastewater Services]: PO 12.2 Interface between Land Uses [Activities Generating Noise or Vibration]: PO 4.1 Transport, Access and Parking [Movement Systems]: PO 1.4 Transport, Access and Parking [Vehicle Access]: PO 3.1	None	Airport Building Heights (Aircraft Landing Area): PO 1.1, 1.2 Building Near Airfields: PO 1.1 Coastal Areas: All Hazards (Acid Sulfate Soils): PO 1.1 Hazards (Bushfire - General Risk): All Hazards (Bushfire - Medium Risk): All Hazards (Bushfire - Outback): All Hazards (Bushfire - Regional): All Hazards (Flooding): All Historic Shipwrecks: PO 1.1 Key Outback and Rural Routes: PO 8.1, 10.1 Key Railway Crossings: PO 1.1 Local Heritage Place: All Marine Parks (Managed Use): All Marine Parks (Restricted Use): All Murray Darling Basin: All

Class of Development**Applicable Policies**

The following policies are applicable to the assessment of the identified Class of Development. Policies referred to are Performance Outcome policies, and any associated Designated Performance Features. Relevant Desired Outcomes are not listed, but automatically apply in relation to a Performance Assessed Development.

Where a development comprises more than one Class of Development the relevant policies will be taken to be the sum of the applicable policies for each Class of Development.

Zone**General Development Policies****Subzone**

(applies only in the area affected by the Subzone)

Overlay

(applies only in the area affected by the Overlay)

				Native Vegetation: PO 1.1, 1.2 Ramsar Wetlands: All River Murray Flood Plain: All Significant Landscape Protection: All Sloping Land: All State Heritage Area: All State Heritage Place: All State Significant Native Vegetation: PO 1.1 Urban Transport Routes: PO 8.1, 10.1 Water Protection Area: All Water Resources: All
Carport Outbuilding (in the form of a garage)	None	Clearance from Overhead Powerlines Overlay PO 1.1	None	Airport Building Heights (Aircraft Landing Area): PO 1.1, 1.2 Building Near Airfields: PO 1.1 Coastal Areas: All

Class of Development

Applicable Policies

The following policies are applicable to the assessment of the identified Class of Development. Policies referred to are Performance Outcome policies, and any associated Designated Performance Features. Relevant Desired Outcomes are not listed, but automatically apply in relation to a Performance Assessed Development.

Where a development comprises more than one Class of Development the relevant policies will be taken to be the sum of the applicable policies for each Class of Development.

Zone

General Development Policies

Subzone

(applies only in the area affected by the Subzone)

Overlay

(applies only in the area affected by the Overlay)

Design in Rural Areas [All Residential Development – Ancillary Development] Overlay PO 13.1, 13.2

Infrastructure and Renewable Energy Facilities [Wastewater Services] Overlay PO 12.2

Transport, Access and Parking [Vehicle Access] Overlay PO 3.1, 3.5

- Hazards (Acid Sulfate Soils): PO 1.1
- Historic Shipwrecks Overlay PO 1.1
- Hazards (Bushfire - General Risk): All
- Hazards (Bushfire - Medium Risk): All
- Hazards (Bushfire - Outback): All
- Hazards (Bushfire - Regional): All
- Hazards (Flooding): All
- Key Outback and Rural Routes: All
- Key Railway Crossings: PO 1.1
- Local Heritage Place: All
- Marine Parks (Managed Use): All

Class of Development

Applicable Policies

The following policies are applicable to the assessment of the identified Class of Development. Policies referred to are Performance Outcome policies, and any associated Designated Performance Features. Relevant Desired Outcomes are not listed, but automatically apply in relation to a Performance Assessed Development.
Where a development comprises more than one Class of Development the relevant policies will be taken to be the sum of the applicable policies for each Class of Development.

Zone

General Development Policies

Subzone
(applies only in the area affected by the Subzone)

Overlay
(applies only in the area affected by the Overlay)

- Marine Parks (Restricted Use): All
- Murray Darling Basin: All
- Native Vegetation: PO 1.1, 1.2
- Ramsar Wetlands: All
- River Murray Flood Plain: All
- Significant Landscape Protection: All
- Sloping Land: All
- State Heritage Area: All
- State Heritage Place: All
- State Significant Native Vegetation: PO 1.1
- Urban Transport Routes: All
- Water Protection Area: All
- Water Resources: All

Class of Development	Applicable Policies			
	Zone	General Development Policies	Subzone (applies only in the area affected by the Subzone)	Overlay (applies only in the area affected by the Overlay)
Demolition of a State or Local Heritage Place	None	None	None	Local Heritage Place: All State Heritage Place: All
Demolition within the Historic Area Overlay or the State Heritage Area Overlay	None	None	None	Historic Area: All State Heritage Area: All
Detached dwelling	All	Clearance from Overhead Powerlines Overlay PO 1.1 Design in Rural Areas [All Development - On-site Waste Treatment Systems] Overlay PO 6.1 Infrastructure and Renewable Energy Facilities [Water Supply] Overlay PO 11.1	None	Airport Building Heights (Aircraft Landing Area): PO 1.1, 1.2 Building Near Airfields: PO 1.1 Coastal Areas: All Hazards (Acid Sulfate Soils): PO 1.1 Hazards (Bushfire - General Risk): All Hazards (Bushfire - Medium Risk): All

Class of Development

Applicable Policies

The following policies are applicable to the assessment of the identified Class of Development. Policies referred to are Performance Outcome policies, and any associated Designated Performance Features. Relevant Desired Outcomes are not listed, but automatically apply in relation to a Performance Assessed Development.

Where a development comprises more than one Class of Development the relevant policies will be taken to be the sum of the applicable policies for each Class of Development.

Zone

General Development Policies

Subzone

(applies only in the area affected by the Subzone)

Overlay

(applies only in the area affected by the Overlay)

Infrastructure and Renewable Energy Facilities [Wastewater Services] Overlay PO 12.1, 12.2

Interface Between Land Uses [Interface with Mines and Quarries (Rural and Remote Areas) Overlay PO 10.1

Site Contamination Overlay PO 1.1

Transport, Access and Parking [Vehicle Access] Overlay PO 3.1, 3.5, 3.6

Hazards (Bushfire - Outback): All

Hazards (Bushfire - Regional): All

Hazards (Flooding): All

Historic Shipwrecks: PO 1.1

Key Outback and Rural Routes: All

Key Railway Crossings: PO 1.1

Local Heritage Place: All

Marine Parks (Managed Use): All

Marine Parks (Restricted Use): All

Murray Darling Basin: All

Native Vegetation: PO 1.1, 1.2

Prescribed Watercourses: All

Prescribed Wells Area: All

Ramsar Wetlands: All

Class of Development

Applicable Policies

The following policies are applicable to the assessment of the identified Class of Development. Policies referred to are Performance Outcome policies, and any associated Designated Performance Features. Relevant Desired Outcomes are not listed, but automatically apply in relation to a Performance Assessed Development.

Where a development comprises more than one Class of Development the relevant policies will be taken to be the sum of the applicable policies for each Class of Development.

Zone

General Development Policies

Subzone

(applies only in the area affected by the Subzone)

Overlay

(applies only in the area affected by the Overlay)

- Resource Extraction Protection Area: All
- River Murray Flood Plain: All
- Significant Landscape Protection: All
- Sloping Land: All
- State Heritage Area: All
- State Heritage Place: All
- State Significant Native Vegetation: PO 1.1
- Strategic Infrastructure Gas Pipelines Overlay PO 1.2
- Urban Transport Routes Overlay All
- Water Protection Area: All
- Water Resources: All

Class of Development**Applicable Policies**

The following policies are applicable to the assessment of the identified Class of Development. Policies referred to are Performance Outcome policies, and any associated Designated Performance Features. Relevant Desired Outcomes are not listed, but automatically apply in relation to a Performance Assessed Development.

Where a development comprises more than one Class of Development the relevant policies will be taken to be the sum of the applicable policies for each Class of Development.

Zone**General Development Policies****Subzone**

(applies only in the area affected by the Subzone)

Overlay

(applies only in the area affected by the Overlay)

Dwelling addition

[Built Form and Character] Overlay PO 2.2

Clearance from Overhead Powerlines Overlay PO 1.1
 Design in Rural Areas [All Development - On-site Waste Treatment Systems] Overlay PO 6.1

None

Airport Building Heights (Aircraft Landing Area) Overlay PO 1.1, 1.2
 Building Near Airfields Overlay PO 1.1
 Coastal Areas: All
 Hazards (Acid Sulfate Soils): PO 1.1
 Hazards (Bushfire - General Risk): All
 Hazards (Bushfire - Medium Risk): All
 Hazards (Bushfire - Outback): All
 Hazards (Bushfire - Regional): All

Class of Development

Applicable Policies

The following policies are applicable to the assessment of the identified Class of Development. Policies referred to are Performance Outcome policies, and any associated Designated Performance Features. Relevant Desired Outcomes are not listed, but automatically apply in relation to a Performance Assessed Development.

Where a development comprises more than one Class of Development the relevant policies will be taken to be the sum of the applicable policies for each Class of Development.

Zone

General Development Policies

Subzone

(applies only in the area affected by the Subzone)

Overlay

(applies only in the area affected by the Overlay)

- Hazards (Flooding): All
- Historic Shipwrecks: PO 1.1
- Local Heritage Place: All
- Marine Parks (Managed Use): All
- Marine Parks (Restricted Use): All
- Murray Darling Basin: All
- Native Vegetation: PO 1.1, 1.2
- Prescribed Watercourses: All
- Prescribed Wells Area: All
- Ramsar Wetlands: All
- Resource Extraction Protection Area: All
- River Murray Flood Plain: All

Class of Development

Applicable Policies

The following policies are applicable to the assessment of the identified Class of Development. Policies referred to are Performance Outcome policies, and any associated Designated Performance Features. Relevant Desired Outcomes are not listed, but automatically apply in relation to a Performance Assessed Development.
Where a development comprises more than one Class of Development the relevant policies will be taken to be the sum of the applicable policies for each Class of Development.

Zone

General Development Policies

Subzone
(applies only in the area affected by the Subzone)

Overlay
(applies only in the area affected by the Overlay)

- Significant Landscape Protection: All
- Sloping Land: All
- State Heritage Area: All
- State Heritage Place: All
- State Significant Native Vegetation: PO 1.1
- Strategic Infrastructure Gas Pipelines: PO 1.2
- Water Protection Area: All
- Water Resources: All

Excavation and filling

None

Design in Rural Areas [Earthworks]
Overlay PO 8.1

None

- Coastal Areas: All
- Hazards (Acid Sulfate Soils): PO 1.1.

Class of Development

Applicable Policies

The following policies are applicable to the assessment of the identified Class of Development. Policies referred to are Performance Outcome policies, and any associated Designated Performance Features. Relevant Desired Outcomes are not listed, but automatically apply in relation to a Performance Assessed Development.

Where a development comprises more than one Class of Development the relevant policies will be taken to be the sum of the applicable policies for each Class of Development.

Zone

General Development Policies

Subzone

(applies only in the area affected by the Subzone)

Overlay

(applies only in the area affected by the Overlay)

- Hazards (Flooding): All
- Historic Shipwrecks Overlay PO 1.1
- Local Heritage Place: All
- Marine Parks (Managed Use): All
- Marine Parks (Restricted Use): All
- Murray Darling Basin: All
- Native Vegetation: PO 1.1, 1.2
- Prescribed Watercourses: All
- Prescribed Wells Area: All
- Ramsar Wetlands: All
- Resource Extraction Protection Area: All
- River Murray Flood Plain: All

Class of Development

Applicable Policies

The following policies are applicable to the assessment of the identified Class of Development. Policies referred to are Performance Outcome policies, and any associated Designated Performance Features. Relevant Desired Outcomes are not listed, but automatically apply in relation to a Performance Assessed Development.
Where a development comprises more than one Class of Development the relevant policies will be taken to be the sum of the applicable policies for each Class of Development.

Zone

General Development Policies

Subzone

(applies only in the area affected by the Subzone)

Overlay

(applies only in the area affected by the Overlay)

Significant Landscape Protection: All
Sloping Land: All
State Heritage Area: All
State Heritage Place: All
State Significant Native Vegetation: PO 1.1
Strategic Infrastructure Gas Pipelines: PO 1.2
Water Protection Area: All
Water Resources: All

Farming

None

Interface Between Land Uses [General Land Use Compatibility] Overlay PO 1.2

None

Coastal Areas: All
Local Heritage Place: All

Class of Development

Applicable Policies

The following policies are applicable to the assessment of the identified Class of Development. Policies referred to are Performance Outcome policies, and any associated Designated Performance Features. Relevant Desired Outcomes are not listed, but automatically apply in relation to a Performance Assessed Development.

Where a development comprises more than one Class of Development the relevant policies will be taken to be the sum of the applicable policies for each Class of Development.

Zone

General Development Policies

Subzone

(applies only in the area affected by the Subzone)

Overlay

(applies only in the area affected by the Overlay)

- Marine Parks (Managed Use): All
- Marine Parks (Restricted Use): All
- Murray Darling Basin: All
- Native Vegetation: PO 1.1, 1.2
- Ramsar Wetlands: All
- River Murray Flood Plain: All
- Significant Landscape Protection: All
- State Heritage Area: All
- State Heritage Place: All
- State Significant Native Vegetation: PO 1.1
- Water Protection Area: All
- Water Resources: All

Class of Development

Applicable Policies

The following policies are applicable to the assessment of the identified Class of Development. Policies referred to are Performance Outcome policies, and any associated Designated Performance Features. Relevant Desired Outcomes are not listed, but automatically apply in relation to a Performance Assessed Development.
 Where a development comprises more than one Class of Development the relevant policies will be taken to be the sum of the applicable policies for each Class of Development.

Zone

General Development Policies

Subzone
 (applies only in the area affected by the Subzone)

Overlay
 (applies only in the area affected by the Overlay)

Fence

None

Design in Rural Areas [All Development – Fences and Walls]
 Overlay PO 9.1

None

Airport Building Heights (Aircraft Landing Area): PO 1.1, 1.2
 Building Near Airfields: PO 1.1
 Coastal Areas: All
 Hazards (Acid Sulfate Soils): PO 1.1
 Hazards (Flooding): All
 Historic Shipwrecks: PO 1.1
 Local Heritage Place: All
 Marine Parks (Managed Use): All
 Marine Parks (Restricted Use): All
 Murray Darling Basin: All
 Native Vegetation: PO 1.1, 1.2
 Ramsar Wetlands: All

Class of Development**Applicable Policies**

The following policies are applicable to the assessment of the identified Class of Development. Policies referred to are Performance Outcome policies, and any associated Designated Performance Features. Relevant Desired Outcomes are not listed, but automatically apply in relation to a Performance Assessed Development.

Where a development comprises more than one Class of Development the relevant policies will be taken to be the sum of the applicable policies for each Class of Development.

Zone**General Development Policies****Subzone**

(applies only in the area affected by the Subzone)

Overlay

(applies only in the area affected by the Overlay)

				River Murray Flood Plain: All Significant Landscape Protection: All Sloping Land: All State Heritage Area: All State Heritage Place: All State Significant Native Vegetation: PO 1.1 Water Protection Area: All Water Resources: All
--	--	--	--	---

**Outbuilding (not being a garage)
Verandah**

None

Clearance from Overhead Powerlines
Overlay PO 1.1

None

Airport Building Heights (Aircraft Landing Area): PO 1.1, 1.2
 Building Near Airfields: PO 1.1
 Coastal Areas: All

Class of Development	Applicable Policies			
	Zone	General Development Policies	Subzone (applies only in the area affected by the Subzone)	Overlay (applies only in the area affected by the Overlay)
		<p>Design in Rural Areas [All Residential Development – Ancillary Development] Overlay PO 13.1, 13.2</p> <p>Infrastructure and Renewable Energy Facilities [Wastewater Services] Overlay PO 12.2</p>		<p>Hazards (Acid Sulfate Soils): PO 1.1</p> <p>Hazards (Bushfire - General Risk): All</p> <p>Hazards (Bushfire - Medium Risk): All</p> <p>Hazards (Bushfire - Outback): All</p> <p>Hazards (Bushfire - Regional): All</p> <p>Hazards (Flooding): All</p> <p>Historic Shipwrecks: PO 1.1</p> <p>Local Heritage Place: All</p> <p>Marine Parks (Managed Use): All</p> <p>Marine Parks (Restricted Use): All</p> <p>Murray Darling Basin: All</p> <p>Native Vegetation: PO 1.1, 1.2</p>

Class of Development**Applicable Policies**

The following policies are applicable to the assessment of the identified Class of Development. Policies referred to are Performance Outcome policies, and any associated Designated Performance Features. Relevant Desired Outcomes are not listed, but automatically apply in relation to a Performance Assessed Development.

Where a development comprises more than one Class of Development the relevant policies will be taken to be the sum of the applicable policies for each Class of Development.

Zone**General Development Policies****Subzone**

(applies only in the area affected by the Subzone)

Overlay

(applies only in the area affected by the Overlay)

Ramsar Wetlands: All
 River Murray Flood Plain: All
 Significant Landscape Protection: All
 Sloping Land: All
 State Heritage Area: All
 State Heritage Place: All
 State Significant Native Vegetation: PO 1.1
 Water Protection Area: All
 Water Resources: All

Solar farm

[Land Use and Intensity]

Clearance from Overhead Powerlines Overlay PO 1.1

None

Airport Building Heights (Aircraft Landing Area): PO 1.1, 1.2
 Building Near Airfields: PO 1.1

Class of Development

Applicable Policies

The following policies are applicable to the assessment of the identified Class of Development. Policies referred to are Performance Outcome policies, and any associated Designated Performance Features. Relevant Desired Outcomes are not listed, but automatically apply in relation to a Performance Assessed Development.

Where a development comprises more than one Class of Development the relevant policies will be taken to be the sum of the applicable policies for each Class of Development.

Zone

General Development Policies

Subzone

(applies only in the area affected by the Subzone)

Overlay

(applies only in the area affected by the Overlay)

Overlay PO 1.1 [Built Form and Character] Overlay PO 2.1, 2.2

Infrastructure and Renewable Energy Facilities [General] Overlay PO 1.1
 Infrastructure and Renewable Energy Facilities [Visual Amenity] Overlay PO 2.1, 2.2, 2.3
 Infrastructure and Renewable Energy Facilities [Rehabilitation] Overlay PO 3.1
 Infrastructure and Renewable Energy Facilities [Hazard Management] Overlay PO 4.1, 4.2, 4.3
 Infrastructure and Renewable Energy Facilities [Electricity Infrastructure and Battery Storage Facilities] Overlay PO 5.1

Coastal Areas: All
 Hazards (Acid Sulfate Soils): PO 1.1
 Hazards (Flooding): All
 Historic Shipwrecks: PO 1.1
 Key Outback and Rural Routes: All
 Key Railway Crossings: PO 1.1
 Local Heritage Place: All
 Marine Parks (Managed Use): All
 Marine Parks (Restricted Use): All
 Murray Darling Basin: All
 Native Vegetation: PO 1.1, 1.2
 Prescribed Watercourses: All
 Prescribed Wells Area: All

Class of Development

Applicable Policies

The following policies are applicable to the assessment of the identified Class of Development. Policies referred to are Performance Outcome policies, and any associated Designated Performance Features. Relevant Desired Outcomes are not listed, but automatically apply in relation to a Performance Assessed Development.
 Where a development comprises more than one Class of Development the relevant policies will be taken to be the sum of the applicable policies for each Class of Development.

Zone

General Development Policies

Subzone
 (applies only in the area affected by the Subzone)

Overlay
 (applies only in the area affected by the Overlay)

Infrastructure and Renewable Energy Facilities [Renewable Energy Facilities] Overlay PO 7.1

Infrastructure and Renewable Energy Facilities [Renewable Energy Facilities (Solar Power)] Overlay PO 9.1, 9.2

Infrastructure and Renewable Energy Facilities [Temporary Facilities] Overlay PO 13.1, 13.2

Design in Rural Areas [All Non-Residential Development – Wash-down and Waste Loading and Unloading] Overlay PO 31.1

Interface Between Land Uses [General land use compatibility] Overlay PO 1.2

Ramsar Wetlands: All

River Murray Flood Plain: All

Significant Landscape Protection: All

Sloping Land: All

State Heritage Area: All

State Heritage Place: All

State Significant Native Vegetation: PO 1.1

Strategic Infrastructure Gas Pipelines Overlay: PO 1.2

Urban Transport Routes: All

Water Protection Area: All

Water Resources: All

Class of Development

Applicable Policies

The following policies are applicable to the assessment of the identified Class of Development. Policies referred to are Performance Outcome policies, and any associated Designated Performance Features. Relevant Desired Outcomes are not listed, but automatically apply in relation to a Performance Assessed Development.

Where a development comprises more than one Class of Development the relevant policies will be taken to be the sum of the applicable policies for each Class of Development.

Zone

General Development Policies

Subzone

(applies only in the area affected by the Subzone)

Overlay

(applies only in the area affected by the Overlay)

Interface Between Land Uses [Activities Generating Noise or Vibration] Overlay PO 4.1

Interface Between Land Uses [Solar Reflectivity / Glare] Overlay PO 7.1

Transport, Access and Parking [Movement Systems] Overlay PO 1.1, 1.4

Transport, Access and Parking [Sightlines] Overlay PO 2.1

Transport, Access and Parking [Vehicle Access] Overlay PO 3.1, 3.3, 3.4, 3.8, 3.9

Transport, Access and Parking [Vehicle Parking Areas] Overlay PO 6.1, 6.2, 6.6

Class of Development	Applicable Policies			
	Zone	General Development Policies	Subzone (applies only in the area affected by the Subzone)	Overlay (applies only in the area affected by the Overlay)
Wind farm	[Land Use and Intensity] Overlay PO 1.1 [Built Form and Character] Overlay PO 2.1, 2.2	Clearance from Overhead Powerlines Overlay PO 1.1 Infrastructure and Renewable Energy Facilities [General] Overlay PO 1.1 Infrastructure and Renewable Energy Facilities [Visual Amenity] Overlay PO 2.1, 2.2, 2.3 Infrastructure and Renewable Energy Facilities [Rehabilitation] Overlay PO 3.1 Infrastructure and Renewable Energy Facilities [Hazard Management] Overlay PO 4.1, 4.2, 4.3 Infrastructure and Renewable Energy Facilities [Electricity	None	Airport Building Heights (Aircraft Landing Area): PO 1.1, 1.2 Building Near Airfields: PO 1.1 Coastal Areas: All Hazards (Acid Sulfate Soils): PO 1.1 Hazards (Bushfire - General Risk): All Hazards (Bushfire - Medium Risk): All Hazards (Bushfire - Outback): All Hazards (Bushfire - Regional): All Historic Shipwrecks: PO 1.1 Hazards (Flooding): All Key Outback and Rural Routes: All Key Railway Crossings: PO 1.1

Class of Development

Applicable Policies

The following policies are applicable to the assessment of the identified Class of Development. Policies referred to are Performance Outcome policies, and any associated Designated Performance Features. Relevant Desired Outcomes are not listed, but automatically apply in relation to a Performance Assessed Development.
 Where a development comprises more than one Class of Development the relevant policies will be taken to be the sum of the applicable policies for each Class of Development.

Zone

General Development Policies

Subzone

(applies only in the area affected by the Subzone)

Overlay

(applies only in the area affected by the Overlay)

Infrastructure and Battery Storage Facilities] Overlay PO 5.1
 Infrastructure and Renewable Energy Facilities [Renewable Energy Facilities] Overlay PO 7.1
 Infrastructure and Renewable Energy Facilities [Renewable Energy Facilities (Wind Farm)] Overlay PO 8.1, 8.2, 8.3, 8.4, 8.5
 Infrastructure and Renewable Energy Facilities [Temporary Facilities] Overlay PO 13.1, 13.2
 Design in Rural Areas [All Non-Residential Development – Wash-down and Waste Loading and Unloading] Overlay PO 31.1

Local Heritage Place: All
 Marine Parks (Managed Use): All
 Marine Parks (Restricted Use): All
 Murray Darling Basin: All
 Native Vegetation: PO 1.1, 1.2
 Ramsar Wetlands: All
 Resource Extraction Protection Area: All
 River Murray Flood Plain: All
 Significant Landscape Protection: All
 Sloping Land: All
 State Heritage Area: All
 State Heritage Place: All

Class of Development

Applicable Policies

The following policies are applicable to the assessment of the identified Class of Development. Policies referred to are Performance Outcome policies, and any associated Designated Performance Features. Relevant Desired Outcomes are not listed, but automatically apply in relation to a Performance Assessed Development.

Where a development comprises more than one Class of Development the relevant policies will be taken to be the sum of the applicable policies for each Class of Development.

Zone

General Development Policies

Subzone

(applies only in the area affected by the Subzone)

Overlay

(applies only in the area affected by the Overlay)

Interface Between Land Uses [General land use compatibility] Overlay PO 1.2

Interface Between Land Uses [Overshadowing] Overlay PO 3.4

Interface Between Land Uses [Activities Generating Noise or Vibration] Overlay PO 4.1

Interface Between Land Uses [Solar Reflectivity / Glare] Overlay PO 7.1

Transport, Access and Parking [Movement Systems] Overlay PO 1.1, 1.4

Transport, Access and Parking [Sightlines] Overlay PO 2.1

State Significant Native Vegetation: PO 1.1
Strategic Infrastructure Gas Pipelines: PO 1.2
Urban Transport Routes: All
Water Protection Area: All
Water Resources: All

Class of Development

Applicable Policies

The following policies are applicable to the assessment of the identified Class of Development. Policies referred to are Performance Outcome policies, and any associated Designated Performance Features. Relevant Desired Outcomes are not listed, but automatically apply in relation to a Performance Assessed Development.
Where a development comprises more than one Class of Development the relevant policies will be taken to be the sum of the applicable policies for each Class of Development.

Zone

General Development Policies

Subzone

(applies only in the area affected by the Subzone)

Overlay

(applies only in the area affected by the Overlay)

Transport, Access and Parking [Vehicle Access] Overlay PO 3.1, 3.3, 3.4, 3.8, 3.9

Transport, Access and Parking [Vehicle Parking Areas] Overlay PO 6.1, 6.2, 6.6

All other Code Assessed Development

All

All

None

Any Relevant Overlay: All

Table 4 –Restricted Development Classification

Class of Development The following Classes of Development are classified as Restricted	
None Specified	

Assessment Provisions

Desired Outcome (DO)

DO 1

A diverse range of activities from pastoral, grazing and farming activities, agricultural processing and transportation, mining and petroleum (and associated settlement activities), the generation and storage of energy, pipelines or infrastructure, aerospace and defence related facilities (and associated settlement activities), tourism, remote settlements, Aboriginal lands and related rural land activities.

Performance Outcomes and Deemed to Satisfy / Designated Performance Outcome Criteria

Land Use and Intensity

PO 1.1

The productive value of land for a range of rural activities.

DTS/DPF 1.1

Development comprises one or more of the following land uses:

- (a) Advertisement
- (b) Agricultural building
- (c) Carport
- (d) Demolition
- (e) Detached dwelling
- (f) Dwelling addition
- (g) Excavation and filling
- (h) Farming
- (i) Intensive animal husbandry
- (j) Outbuilding
- (k) Small-scale ground mounted solar power facility
- (l) Solar farm
- (m) Stock sales yard
- (n) Stock slaughter works
- (o) Tourist accommodation
- (p) Verandah
- (q) Wind farm

Built Form and Character

PO 2.1

Development sited and designed to protect natural features and the conservation value of the area.

DTS/DPF 2.1

None are applicable.

PO 2.2

Large buildings designed and sited to reduce impacts on scenic and rural vistas by:

- (a) having substantial setbacks from boundaries and adjacent public roads
- (b) using low reflective materials and finishes that blend with the surrounding landscape; and
- (c) being located below ridgelines where practicable.

DTS/DPF 2.2

Building are:

- (a) of a height no greater than 2 building levels and 9m; and
- (b) setback at least 40m from any allotment boundary or public road.

Hazard Risk Minimisation

PO 3.1

Habitable buildings designed and sited to manage the risks of natural hazards on personal and public safety and property.

DTS/DPF 3.1

None are applicable.

Procedural Matters (PM)

Notification

All classes of performance assessed development are excluded from notification except where they involve any of the following:

- (a) the site of the development is adjacent land to land in a different zone
- (b) development identified as "all other code assessed development" in Remote Areas Zone Table 3
- (c) wind farm and ancillary development including electricity substation, maintenance sheds, access roads, and connecting power-lines where the base of any wind turbine is 2,000m or less from:
 - (i) an existing dwelling or tourist accommodation that is not associated with the wind farm;
 - (ii) a proposed dwelling or tourist accommodation for which an operable planning consent exists;
 - (iii) the boundaries of any airfield, airport, Local Infrastructure (Airfield) Zone, Settlement Zone, Township Zone or any State Heritage Area Overlay;
- (d) wind monitoring mast and ancillary development.

Residential Neighbourhood Zone

Table 1 – Accepted Development Classification

Class of Development The following Classes of Development are classified as Accepted Development subject to meeting the 'Accepted Development Classification Criteria'	Accepted Development Classification Criteria
Building work on railway land	4 Building work is associated with a railway 5 It is situated (or to be situated) on railway land 6 It is required for the conduct or maintenance of railway activities.
Carport Except where any of the following apply: <ul style="list-style-type: none"> • Character Preservation District Overlay • Hazards (Flooding) Overlay • Character Area Overlay • Historic Area Overlay • Local Heritage Place Overlay • State Heritage Area Overlay • State Heritage Place Overlay • Native Vegetation Overlay • State Significant Native Vegetation Overlay • Ramsar Wetlands Overlay • River Murray Flood Plain Overlay • Sloping Land Overlay • Future Road Widening Overlay where an existing access is altered or a new access is created • Key Outback and Rural Routes Overlay where an existing access is altered or a new access is created • Key Railway Crossings Overlay where an existing access is 	14 The development will not be built, or encroach, on an area that is, or will be, required for a sewerage system or waste control system 15 It is ancillary to a dwelling erected on the site 16 Primary street setback – at least 5.5m from the primary street boundary and as far back as the building line of the building to which it is ancillary 17 Secondary street setback – at least 900mm from the boundary of the allotment (if the land has boundaries on two or more roads) 18 Total floor area - does not exceed 40m ² 19 Post height - does not exceed 3m measured from natural ground level (and not including a gable end) 20 Building height - does not exceed 5m 21 If situated on or abutting a boundary (not being a boundary with a primary street or secondary street) – a length not exceeding 10m unless: <ul style="list-style-type: none"> (a) a longer wall or structure exists on the adjacent site and is situated on the same allotment boundary; and (b) the proposed wall or structure will be built along the same length of boundary as the existing adjacent wall or structure to the same or lesser extent 22 If the carport abuts or is situated on the boundary of the allotment (not being a boundary with a primary street or secondary street): <ul style="list-style-type: none"> (a) it will not result in all relevant walls or structures located along the boundary exceeding 45% of the length of the boundary; and (b) it will not be located within 3m of any other wall along the same boundary unless on an adjacent site on that boundary there is an existing wall of a building that

<p>altered or a new access is created</p> <ul style="list-style-type: none"> • Major Urban Transport Routes Overlay where an existing access is altered or a new access is created • Non-stop Corridor Overlay where an existing access is altered or a new access is created • Urban Transport Routes Overlay where an existing access is altered or a new access is created • Water Resources Overlay 	<p>would be adjacent to or abut the proposed wall or structure</p> <p>23 The total roofed area of all existing or proposed buildings on the allotment does not exceed 50% of the area of the allotment</p> <p>24 Door opening for vehicle access – does not exceed, in total, 7m in width or 50% of the width of the allotment frontage (whichever lesser)</p> <p>25 Internal dimensions – does not exceed 3.2m in width and 6m in length between all fences, walls and doors</p> <p>26 The carport:</p> <p>(a) is located so that vehicle access:</p> <ul style="list-style-type: none"> i. is provided via a lawfully existing or authorised driveway or access point or an access point for which consent has been granted as part of an application for the division of land; or ii. will use a driveway that: <ul style="list-style-type: none"> A. is not located within 6 metres of an intersection of 2 or more roads or a pedestrian actuated crossing; and B. will not interfere with an item of street furniture (including directional signs, lighting, seating and weather shelters), other infrastructure, or a tree; or iii. if adjacent a kerbed road, will be via a kerb that is designed to allow a vehicle to roll over it; and <p>(b) is located so that the gradient from the place of access on the boundary of the allotment to the finished floor level at the front of the carport when the work is completed is not steeper than 1:4 on average; and</p> <p>The centre of the driveway at the public road boundary is no more than 25 degree deviation from the centre of the front of the covered car parking space for which it provides vehicle access</p>
<p>Demolition Except where any of the following apply:</p> <ul style="list-style-type: none"> • Historic Area Overlay • A Local Heritage Place identified in the Local Heritage Place Overlay • State Heritage Area Overlay • A State Heritage Place identified in the State Heritage Place Overlay 	<p>None.</p>
<p>Internal building work Except where any of the following apply:</p> <ul style="list-style-type: none"> • A Local Heritage Place identified in the Local Heritage Place Overlay 	<p>3 There will be no increase in the total floor area of the building</p> <p>4 There will be no alteration to the external appearance of the building.</p>

<ul style="list-style-type: none"> • State Heritage Area Overlay • A State Heritage Place identified in the State Heritage Place Overlay 	
<p>Outbuilding (in the form of a garage) Except where any of the following apply:</p> <ul style="list-style-type: none"> • Character Preservation District Overlay • Hazards (Bushfire – High Risk) Overlay • Hazards (Bushfire - Medium Risk) Overlay • Hazards (Bushfire - General Risk) Overlay • Hazard (Bushfire – Regional) Overlay • Hazards (Flooding) Overlay • Character Area Overlay • Historic Area Overlay • Local Heritage Place Overlay • State Heritage Area Overlay • State Heritage Place Overlay • Native Vegetation Overlay • State Significant Native Vegetation Overlay • Ramsar Wetlands Overlay • River Murray Flood Plain Overlay • Sloping Land Overlay • Future Road Widening Overlay where an existing access is altered or a new access is created • Key Outback and Rural Routes Overlay where an existing access is altered or a new access is created • Key Railway Crossings Overlay where an existing access is altered or a new access is created • Major Urban Transport Routes Overlay where an existing access is 	<p>15 The development will not be built, or encroach, on an area that is, or will be, required for a sewerage system or waste control system</p> <p>16 It is detached from and ancillary to a dwelling erected on the site.</p> <p>17 Primary street setback – at least 5.5m from the primary street boundary and as far back as the building line of the building to which it is ancillary</p> <p>18 Secondary street setback – at least 900mm from the boundary of the allotment (if the land has boundaries on two or more roads)</p> <p>19 Total floor area - does not exceed 40m²</p> <p>20 Wall height - does not exceed 3m measured from natural ground level (and not including a gable end)</p> <p>21 Building height - does not exceed 5m</p> <p>22 If situated on or abutting a boundary (not being a boundary with a primary street or secondary street) – a length not exceeding 10m unless:</p> <p>(a) a longer wall or structure exists on the adjacent site and is situated on the same allotment boundary; and</p> <p>(b) the proposed wall or structure will be built along the same length of boundary as the existing adjacent wall or structure to the same or lesser extent</p> <p>23 If the outbuilding abuts or is situated on the boundary of the allotment (not being a boundary with a primary street or secondary street):</p> <p>(a) it will not result in all relevant walls or structures located along the boundary exceeding 45% of the length of the boundary; and</p> <p>(b) it will not be located within 3m of any other wall along the same boundary unless on an adjacent site on that boundary there is an existing wall of a building that would be adjacent to or abut the proposed wall or structure</p> <p>24 Total roofed area of all existing and proposed buildings on the allotment - does not exceed 50%</p> <p>25 Internal dimensions – exceed 3.2m in width and 6m in length between all walls and doors</p> <p>26 Door opening for vehicle access – does not exceed, in total, 7m in width or 50% of the width of the allotment frontage (whichever lesser)</p> <p>27 The garage:</p> <p>(a) is located so that vehicle access:</p>

<p>altered or a new access is created</p> <ul style="list-style-type: none"> • Non-stop Corridor Overlay where an existing access is altered or a new access is created • Urban Transport Routes Overlay where an existing access is altered or a new access is created • Water Resources Overlay 	<ul style="list-style-type: none"> i. is provided via a lawfully existing or authorised driveway or access point or an access point for which consent has been granted as part of an application for the division of land; or ii. will use a driveway that: <ul style="list-style-type: none"> A. is not located within 6 metres of an intersection of 2 or more roads or a pedestrian actuated crossing; and B. will not interfere with an item of street furniture (including directional signs, lighting, seating and weather shelters), other infrastructure, or a tree; or iii. if adjacent a kerbed road, will be via a kerb that is designed to allow a vehicle to roll over it; and <p>(b) is located so that the gradient from the place of access on the boundary of the allotment to the finished floor level at the front of the carport when the work is completed is not steeper than 1:4 on average; and</p> <p>(c) The centre of the driveway at the public road boundary is no more than 25 degree deviation from the centre of the front of the covered car parking space for which it provides vehicle access</p> <p>1 If clad in sheet metal—is pre-colour treated or painted in a non-reflective colour.</p>
<p>Outbuilding (not being a garage) Except where any of the following apply:</p> <ul style="list-style-type: none"> • Character Preservation District Overlay • Hazards (Flooding) Overlay • Character Area Overlay • Historic Area Overlay • Local Heritage Place Overlay • State Heritage Area Overlay • State Heritage Place Overlay • Native Vegetation Overlay • State Significant Native Vegetation Overlay • Ramsar Wetlands Overlay • River Murray Flood Plain Overlay • Sloping Land Overlay • Water Resources Overlay 	<p>13 The development will not be built, or encroach, on an area that is, or will be, required for a sewerage system or waste control system</p> <p>14 It is detached from and ancillary to a dwelling erected on the site</p> <p>15 Primary street setback – at least as far back as the building line of the building to which it is ancillary</p> <p>16 Secondary street setback – at least 900mm from the boundary of the allotment (if the land has boundaries on two or more roads)</p> <p>17 Side boundary setbacks – at least 900mm from the boundary of the allotment</p> <p>18 Total floor area does not exceed 40m²</p> <p>19 Wall height - does not exceed 3m measured from natural ground level (and not including a gable end)</p> <p>20 Building height - does not exceed 5m</p> <p>21 If situated on or abutting a boundary (not being a boundary with a primary street or secondary street) – a length not exceeding 10m unless:</p> <ul style="list-style-type: none"> (a) a longer wall or structure exists on the adjacent site and is situated on the same allotment boundary; and (b) the proposed wall or structure will be built along the same length of boundary as the existing adjacent wall or structure to the same or lesser extent

	<p>22 If the outbuilding abuts or is situated on the boundary of the allotment (not being a boundary with a primary street or secondary street):</p> <p>(a) it will not result in all relevant walls or structures located along the boundary exceeding 45% of the length of the boundary; and</p> <p>(b) will not be located within 3m of any other wall along the same boundary unless on an adjacent site on that boundary there is an existing wall of a building that would be adjacent to or abut the proposed wall or structure</p> <p>23 Total roofed area of all existing and proposed buildings on the allotment - does not exceed 50%</p> <p>If clad in sheet metal—is pre-colour treated or painted in a non-reflective colour.</p>
<p>Private bushfire shelters Except where any of the following apply:</p> <ul style="list-style-type: none"> • Character Preservation District Overlay • Hazards (Flooding) Overlay • Character Area Overlay • Historic Area Overlay • Local Heritage Place Overlay • State Heritage Area Overlay • State Heritage Place Overlay • Native Vegetation Overlay • State Significant Native Vegetation Overlay • Ramsar Wetlands Overlay • River Murray Flood Plain Overlay • Sloping Land Overlay • Water Resources Overlay 	<p>18 The development will not be built, or encroach, on an area that is, or will be, required for a sewerage system or waste control system</p> <p>19 Primary street setback – at least as far back as the building to which it is ancillary</p> <p>20 Secondary street setback – at least 900mm from the boundary of the allotment</p> <p>At least 6m from the corner of an allotment which abuts the intersection of two or more roads (other than where a 4m x 4m allotment cut-off is already in place).</p>
<p>Shade sail Except where any of the following apply:</p> <ul style="list-style-type: none"> • Character Preservation District Overlay • Character Area Overlay • Historic Area Overlay • Local Heritage Place Overlay • State Heritage Area Overlay • State Heritage Place Overlay 	<p>8 The development will not be built, or encroach, on an area that is, or will be, required for a sewerage system or waste control system</p> <p>9 Shade sail consists of permeable material</p> <p>10 The total area of the sail - does not exceed 40m²</p> <p>11 No part of the shade sail will be:</p> <p>(a) 3m above ground or floor level (depending on where it is situated) at any place within 900mm of a boundary of the allotment</p> <p>(b) 5m above ground or floor level (depending on where it is situated) within any other part of the allotment</p>

<ul style="list-style-type: none"> • Native Vegetation Overlay • State Significant Native Vegetation Overlay • Ramsar Wetlands Overlay • River Murray Flood Plain Overlay • Sloping Land Overlay • Water Resources Overlay 	<p>12 Primary street setback – at least as far back as the building line of the building to which it is ancillary</p> <p>13 If any part of the sail will be situated on a boundary of the allotment, the length of sail along a boundary does not exceed 8m</p> <p style="padding-left: 40px;">In a case where any part of the sail or a supporting structure will be situated on a side boundary of the allotment — the length of the sail and any such supporting structure together with all relevant walls or structures located along the boundary will not exceed 45% of the length of the boundary.</p>
<p>Solar photovoltaic panels (roof mounted) Except where any of the following apply:</p> <ul style="list-style-type: none"> • Historic Area Overlay • A Local Heritage Place identified in the Local Heritage Place Overlay • State Heritage Area Overlay • A State Heritage Place identified in the State Heritage Place Overlay 	<p>4 Panels are installed parallel to the roof of a building and with the underside surface of the panel not being more than 100mm above the surface of the roof</p> <p>5 Panels and associated components do not overhang any part of the roof</p> <p>Does not apply to system with a generating capacity of more than 5MW that is to be connected to the State's power system.</p>
<p>Spa pool Swimming pool Except where any of the following apply:</p> <ul style="list-style-type: none"> • Character Preservation District Overlay • Hazards (Flooding) Overlay • Character Area Overlay • Historic Area Overlay • Local Heritage Place Overlay • State Heritage Area Overlay • State Heritage Place Overlay • Native Vegetation Overlay • State Significant Native Vegetation Overlay • Ramsar Wetlands Overlay • River Murray Flood Plain Overlay • Sloping Land Overlay <p>Water Resources Overlay</p>	<p>26 The development will not be built, or encroach, on an area that is, or will be, required for a sewerage system or waste control system</p> <p>27 It is ancillary to a dwelling erected on the site</p> <p>28 Allotment boundary setback – not less than 1m</p> <p>29 Primary street setback – at least as far back as the building line of the building to which it is ancillary</p> <p>30 Location of filtration system from a dwelling on an adjoining allotment:</p> <p style="padding-left: 40px;">(a) not less than 5m where the filtration system is located inside a solid structure that will have material impact on the transmission of noise</p> <p>not less than 12m in any other case.</p>
<p>Verandah Except where any of the following apply:</p> <ul style="list-style-type: none"> • Character Preservation District Overlay 	<p>9 The development will not be built, or encroach, on an area that is, or will be, required for a sewerage system or waste control system</p> <p>10 It is ancillary to a dwelling erected on the site</p>

<ul style="list-style-type: none"> • Hazards (Flooding) Overlay • Character Area Overlay • Historic Area Overlay • Local Heritage Place Overlay • State Heritage Area Overlay • State Heritage Place Overlay • Native Vegetation Overlay • State Significant Native Vegetation Overlay • Ramsar Wetlands Overlay • River Murray Flood Plain Overlay • Water Resources Overlay 	<p>11 Primary street setback – as far back as the building line of the building to which it is ancillary</p> <p>12 Total floor area - does not exceed 40m²</p> <p>13 Post height - does not exceed 3m measured from natural ground level</p> <p>14 Building height - does not exceed 5m</p> <p>15 Length - does not exceed 10m if any part of the structure abuts or is situated on a boundary of the allotment</p> <p>16 Total roofed area of all existing and proposed buildings on the allotment - does not exceed 50%.</p>
<p>Water tank (above ground) Except where any of the following apply:</p> <ul style="list-style-type: none"> • Character Preservation District Overlay • Hazards (Flooding) Overlay • Character Area Overlay • Historic Area Overlay • Local Heritage Place Overlay • State Heritage Area Overlay • State Heritage Place Overlay • Native Vegetation Overlay • State Significant Native Vegetation Overlay • Ramsar Wetlands Overlay • River Murray Flood Plain Overlay • Sloping Land Overlay • Water Resources Overlay 	<p>43 The development will not be built, or encroach, on an area that is, or will be, required for a sewerage system or waste control system</p> <p>44 The tank is part of a roof drainage system</p> <p>45 Total floor area - not exceeding 15m²</p> <p>46 The tank is located wholly above ground</p> <p>47 Tank height – does not exceed 4m above natural ground level</p> <p>48 Primary street setback – at least as far back as the building line of the building to which it is ancillary</p> <p>49 In the case of a tank made of metal – the tank is pre-colour treated or painted in a non-reflective colour.</p>
<p>Water tank (underground) Except where any of the following apply:</p> <ul style="list-style-type: none"> • Character Preservation District Overlay • Native Vegetation Overlay 	<p>15 The development will not be built, or encroach, on an area that is, or will be, required for a sewerage system or waste control system</p> <p>The tank (including any associated pump) is located wholly below the level of the ground.</p>

- | | |
|--|--|
| <ul style="list-style-type: none">• State Significant Native Vegetation Overlay• Ramsar Wetlands Overlay• Sloping Land Overlay• Water Resources Overlay | |
|--|--|

Table 2 – Deemed-to-Satisfy Development Classification

Class of Development The following Classes of Development are classified as Deemed-to-Satisfy Development subject to meeting the 'Deemed-to-Satisfy Development Classification Criteria'	Deemed-to-Satisfy Development Classification Criteria Provisions referred to are Deemed-to-Satisfy Criteria Where a development comprises more than one Class of Development the relevant criteria will be taken to be the sum of the criteria for each Class of Development.			
	Zone	General Development Policies	Subzone (applies only in the area affected by the Subzone)	Overlay (applies only in the area affected by the Overlay)
Carport Outbuilding (in the form of a garage) Except where any of the following apply: <ul style="list-style-type: none"> • Building Near Airfields Overlay • Character Area Overlay • Character Preservation District Overlay • Future Road Widening Overlay • Hazards (Bushfire – High Risk) Overlay • Hazards (Bushfire - Medium Risk) Overlay • Hazards (Bushfire - General Risk) Overlay • Hazards (Bushfire - Regional) Overlay • Hazards (Flooding) Overlay • Historic Area Overlay • Local Heritage Place Overlay • Mt Lofty Ranges Catchment (Area 1) Overlay • Mt Lofty Ranges Catchment (Area 2) Overlay • Murray Darling Basin Overlay • Non-stop Corridor Overlay • Ramsar Wetlands Overlay • River Murray Flood Plain Overlay • River Murray Tributaries Area Overlay • Sloping Land Overlay • State Heritage Area Overlay • State Heritage Place Overlay • State Significant Native Vegetation Overlay • Urban Transport Routes Overlay • Water Resources Overlay 	[Ancillary Buildings and Structures] DTS 7.1,7.2	Design in Urban Areas [Residential Development – 3 Building Levels or Less – External Appearance]: DTS 19.1 Design in Urban Areas [Residential Development – 3 Building Levels or Less – Car parking, Access and Manoeuvrability]: All Transport, Access and Parking [Vehicle Access]: DTS 3.1, 3.4, 3.5		Airport Building Heights (Aircraft Landing Areas) Overlay: All Airport Building Heights (Regulated) Overlay: All Defence Aviation Area Overlay: DTS 1.1, 1.3 Key Railway Crossings Overlay: All Major Urban Transport Routes Overlay: All Native Vegetation Overlay [Environmental Protection]: DTS 1.1 State Significant Native Vegetation Areas Overlay [Environmental Protection]: 1.1 Future Road Widening Overlay: All Hazards (Acid Sulfate Soils) Overlay: All Urban Transport Routes Overlay: All
Dwelling addition Except where any of the following apply: <ul style="list-style-type: none"> • Building Near Airfields Overlay • Character Area Overlay • Character Preservation District Overlay • Defence Aviation Area Overlay • Future Road Widening Overlay • Hazards (Bushfire – High Risk) Overlay • Hazards (Bushfire - Medium Risk) Overlay 	[Building Height] DTS 2.1 [Primary Street Setback 3.1] DTS 3.1 [Secondary Street Setback] DTS 4.1 [Side Boundary Setback] DTS 5.1 [Rear Boundary Setback] DTS 6.1	Clearance from Overhead Powerlines: DTS 1.1 Infrastructure and Renewable Energy Facilities [Water Supply]: DTS 11.2 Infrastructure and Renewable Energy Facilities [Wastewater Services]: DTS 12.1, 12.2 Design in Urban Areas [All Residential Development – External Appearance]: DTS 14.1		Airport Building Heights (Aircraft Landing Areas) Overlay: All Airport Building Heights (Regulated) Overlay: All Defence Aviation Area Overlay: DTS 1.1, 1.3 Key Railway Crossings Overlay: All Major Urban Transport Routes Overlay: All Native Vegetation Overlay [Environmental Protection]: DTS 1.1

Class of Development The following Classes of Development are classified as Deemed-to-Satisfy Development subject to meeting the 'Deemed-to-Satisfy Development Classification Criteria'	Deemed-to-Satisfy Development Classification Criteria Provisions referred to are Deemed-to-Satisfy Criteria Where a development comprises more than one Class of Development the relevant criteria will be taken to be the sum of the criteria for each Class of Development.			
	Zone	General Development Policies	Subzone (applies only in the area affected by the Subzone)	Overlay (applies only in the area affected by the Overlay)
<ul style="list-style-type: none"> Hazards (Bushfire - General Risk) Overlay Hazards (Bushfire - Regional) Overlay Hazards (Flooding) Overlay Historic Area Overlay Local Heritage Place Overlay Major Urban Transport Routes Overlay Mt Lofty Ranges Catchment (Area 1) Overlay Mt Lofty Ranges Catchment (Area 2) Overlay Murray Darling Basin Overlay Noise and Air Emissions Overlay Non-stop Corridor Overlay Ramsar Wetlands Overlay River Murray Flood Plain Overlay River Murray Tributaries Area Overlay Sloping Land Overlay State Heritage Area Overlay State Heritage Place Overlay State Significant Native Vegetation Overlay Strategic Infrastructure (Gas Pipelines) Overlay Traffic Generating Development Overlay Urban Transport Routes Overlay Water Resources Overlay 	[Site Dimensions and Land Division]: DTS 8.1 [Site Coverage]: DTS 9.1	Design in Urban Areas [All Residential Development – Outlook and Amenity]: DTS 15.1 Design in Urban Areas [All Residential Development – 3 Building Levels or Less – External Appearance]: DTS 19.1, 19.2, 19.3 Design in Urban Areas [All Residential Development – 3 Building Levels or Less –Overlooking / Visual Privacy]: DTS 20.1 Design in Urban Areas [All Residential Development – 3 Building Levels or Less –Private Open Space]: DTS 21.1, 21.2, 21.3 Design in Urban Areas [All Residential Development – 3 Building Levels or Less –Landscaping]: DTS 22.1, 22.2 Design in Urban Areas [All Residential Development – 3 Building Levels or Less – Waste Storage]: DTS 25.1 Interface Between Land Uses [Overshadowing]: DTS 3.1, 3.2 Interface Between Land Uses [Activities Generating Noise or Vibration]: DTS 4.4 Site Contamination: DTS 1.1		State Significant Native Vegetation Areas Overlay [Environmental Protection]: 1.1 Future Road Widening Overlay: All Hazards (Acid Sulfate Soils) Overlay: All Urban Transport Routes Overlay: All
Detached Dwelling <ul style="list-style-type: none"> Except where any of the following apply: Building Near Airfields Overlay Character Area Overlay Character Preservation District Overlay Defence Aviation Area Overlay Future Road Widening Overlay Hazards (Bushfire – High Risk) Overlay Hazards (Bushfire - Medium Risk) Overlay Hazards (Bushfire - General Risk) Overlay Hazards (Bushfire - Regional) Overlay Hazards (Flooding) Overlay Historic Area Overlay Local Heritage Place Overlay Major Urban Transport Routes Overlay Mt Lofty Ranges Catchment (Area 1) Overlay 	[Building Height] DTS 2.1 [Primary Street Setback 3.1] DTS 3.1 [Secondary Street Setback] DTS 4.1 [Side Boundary Setback] DTS 5.1 [Rear Boundary Setback] DTS 6.1 [Site Dimensions and Land Division]: DTS 8.1 [Site Coverage]: DTS 9.1	Clearance from Overhead Powerlines: DTS 1.1 Infrastructure and Renewable Energy Facilities [Water Supply]: DTS 11.2 Infrastructure and Renewable Energy Facilities [Wastewater Services]: DTS 12.1, 12.2 Transport, Access and Parking [Vehicle Access]: DTS 3.1, 3.5, 3.6 Transport, Access and Parking [Vehicle Parking Rates]: DTS 5.1 Design in Urban Areas [All Development – Car Parking Appearance]: DTS 6.1 Design in Urban Areas [All Residential Development – External Appearance]: DTS 14.1, 14.2		Airport Building Heights (Aircraft Landing Areas) Overlay: All Airport Building Heights (Regulated) Overlay: All Defence Aviation Area Overlay: DTS 1.1, 1.3 Key Railway Crossings Overlay: All Major Urban Transport Routes Overlay: All Native Vegetation Overlay [Environmental Protection]: DTS 1.1 State Significant Native Vegetation Areas Overlay [Environmental Protection]: 1.1 Future Road Widening Overlay: All Hazards (Acid Sulfate Soils) Overlay: All Urban Transport Routes Overlay: All

Class of Development The following Classes of Development are classified as Deemed-to-Satisfy Development subject to meeting the 'Deemed-to-Satisfy Development Classification Criteria'	Deemed-to-Satisfy Development Classification Criteria Provisions referred to are Deemed-to-Satisfy Criteria Where a development comprises more than one Class of Development the relevant criteria will be taken to be the sum of the criteria for each Class of Development.			
	Zone	General Development Policies	Subzone (applies only in the area affected by the Subzone)	Overlay (applies only in the area affected by the Overlay)
<ul style="list-style-type: none"> • Mt Lofty Ranges Catchment (Area 2) Overlay • Murray Darling Basin Overlay • Noise and Air Emissions Overlay • Non-stop Corridor Overlay • Ramsar Wetlands Overlay • River Murray Flood Plain Overlay • River Murray Tributaries Area Overlay • Sloping Land Overlay • State Heritage Area Overlay • State Heritage Place Overlay • State Significant Native Vegetation Overlay • Strategic Infrastructure (Gas Pipelines) Overlay • Water Resources Overlay • No minimum allotment size is provided in the Site Dimensions data layer 		<p>Design in Urban Areas [All Residential Development – Outlook and Amenity]: DTS 15.1</p> <p>Design in Urban Areas [All Residential Development – Access and Servicing]: DTS 16.1</p> <p>Design in Urban Areas [All Residential Development – Flooding]: DTS 18.1</p> <p>Design in Urban Areas [All Residential Development – 3 Building Levels or Less – External Appearance]: DTS 19.1, 19.2, 19.3</p> <p>Design in Urban Areas [All Residential Development – 3 Building Levels or Less –Overlooking / Visual Privacy]: DTS 20.1</p> <p>Design in Urban Areas [All Residential Development – 3 Building Levels or Less –Private Open Space]: DTS 21.1, 21.2</p> <p>Design in Urban Areas [All Residential Development – 3 Building Levels or Less –Landscaping]: DTS 22.1, 22.2</p> <p>Design in Urban Areas [All Residential Development – 3 Building Levels or Less – Water Sensitive Design]: DTS 23.1, 23.2, 23.3</p> <p>Design in Urban Areas [All Residential Development – 3 Building Levels or Less – Car Parking and Manoeuvrability]: DTS 24.1, 24.2, 24.3, 24.4, 24.5, 24.6</p> <p>Design in Urban Areas [All Residential Development – 3 Building Levels or Less – Waste Storage]: DTS 25.1</p> <p>Interface Between Land Uses [Overshadowing]: DTS 3.1, 3.2</p> <p>Interface Between Land Uses [Interface Between Rural Activities]: DTS 9.3, 9.4, 9.5</p> <p>Interface Between Land Uses [Interface with Mines and Quarries (Rural and Remote Areas): DTS 10.1</p> <p>Site Contamination: DTS 1.1</p>		
Excavation and filling		Design in Urban Areas [All Development – Fences and Walls]: DTS 8.2		Native Vegetation Overlay [Environmental Protection]: DTS 1.1

Class of Development The following Classes of Development are classified as Deemed-to-Satisfy Development subject to meeting the 'Deemed-to-Satisfy Development Classification Criteria'	Deemed-to-Satisfy Development Classification Criteria Provisions referred to are Deemed-to-Satisfy Criteria Where a development comprises more than one Class of Development the relevant criteria will be taken to be the sum of the criteria for each Class of Development.			
	Zone	General Development Policies	Subzone (applies only in the area affected by the Subzone)	Overlay (applies only in the area affected by the Overlay)
Except where any of the following apply: <ul style="list-style-type: none"> • Character Area Overlay • Character Preservation District Overlay • Future Road Widening Overlay • Hazards (Flooding) Overlay • Historic Area Overlay • Local Heritage Place Overlay • Mt Lofty Ranges Catchment (Area 1) Overlay • Mt Lofty Ranges Catchment (Area 2) Overlay • Murray Darling Basin Overlay • Non-stop Corridor Overlay • Ramsar Wetlands Overlay • River Murray Flood Plain Overlay • River Murray Tributaries Area Overlay • Sloping Land Overlay • State Heritage Area Overlay • State Heritage Place Overlay • Water Resources Overlay • No minimum allotment size in the Site Dimensions data layer 				State Significant Native Vegetation Areas Overlay [Environmental Protection]: DTS 1.1
Outbuilding (not being a garage) Verandah Except where any of the following apply: <ul style="list-style-type: none"> • Airport Building Heights (Regulated) Overlay • Ramsar Wetlands Overlay • River Murray Flood Plain Overlay • Significant Landscape Protection Overlay • Sloping Land Overlay • State Heritage Areas Overlay • Coastal Areas Overlay 	[Ancillary Buildings and Structures] DTS 7.1,7.2	Design in Urban Areas [Residential Development – 3 Building Levels or Less – External Appearance]: DTS 19.1 Design in Urban Areas [Residential Development – 3 Building Levels or Less – Car parking, Access and Manoeuvrability]: All Transport, Access and Parking [Vehicle Access]: DTS 3.1, 3.4, 3.5		Airport Building Heights (Aircraft Landing Areas) Overlay: All Airport Building Heights (Regulated) Overlay: All Defence Aviation Area Overlay: DTS 1.1, 1.3 Key Railway Crossings Overlay: All Major Urban Transport Routes Overlay: All Native Vegetation Overlay [Environmental Protection]: DTS 1.1 State Significant Native Vegetation Areas Overlay [Environmental Protection]: 1.1 Future Road Widening Overlay: All Hazards (Acid Sulfate Soils) Overlay: All Urban Transport Routes Overlay: All

Table 3 - Applicable Policies for Performance Assessed Development

Class of Development	Applicable Policies			
	Zone	General Development Policies	Subzone	Overlay
	<p>The following policies are applicable to the assessment of the identified Class of Development.</p> <p>Policies referred to are Performance Outcome policies, and any associated Designated Performance Features. Relevant Desired Outcomes are not listed, but automatically apply in relation to a Performance Assessed Development.</p> <p>Where a development comprises more than one Class of Development the relevant policies will be taken to be the sum of the applicable policies for each Class of Development.</p>			
			(applies only in the area affected by the Subzone)	(applies only in the area affected by the Overlay)
Carport Outbuilding (in the form of a garage)	[Ancillary Buildings and Structures] PO 7.1,7.2	Design in Urban Areas [All Residential Development – Ancillary Development]: DTS 17.1, 17.2 Design in Urban Areas [Residential Development – 3 Building Levels or Less – External Appearance]: DTS 19.1 Design in Urban Areas [Residential Development – 3 Building Levels or Less – Car parking, Access and Manoeuvrability]: All Transport, Access and Parking [Vehicle Access]: DTS 3.1, 3.4, 3.5	None	Airport Building Heights (Aircraft Landing Area) Overlay : All Airport Building Heights (Regulated) Overlay : All Building Near Airfields Overlay : All Character Area Overlay : All Character Preservation District Overlay: All Defence Aviation Area Overlay: All Future Road Widening Overlay: All Hazards (Bushfire – High Risk) Overlay: All Hazards (Bushfire - Medium Risk) Overlay: All Hazards (Bushfire - General Risk) Overlay: All Hazards (Bushfire - Regional) Overlay: All Hazards (Flooding) Overlay: All Historic Area Overlay: All Key Railway Crossings Overlay: All Local Heritage Place Overlay: All Major Urban Transport Routes Overlay : All Mt Lofty Ranges Catchment (Area 1) Overlay: All Mt Lofty Ranges Catchment (Area 2) Overlay: All Murray Darling Basin Overlay: All Native Vegetation Overlay: All Non-stop Corridor Overlay: All Prescribed Water Resources Area Overlay: All Ramsar Wetlands Overlay: All Regulated Trees Overlay: All River Murray Flood Plain Overlay: All River Murray Tributaries Area Overlay: All Sloping Land Overlay: All State Heritage Area Overlay: All State Heritage Place Overlay: All State Significant Native Vegetation Overlay: All Traffic Generating Development Overlay: All Urban Transport Routes Overlay: All Water Resources Overlay: All
Demolition of a State or Local Heritage Place	None	None	None	Local Heritage Place: All State Heritage Place: All

Class of Development	Applicable Policies			
	Zone	General Development Policies	Subzone (applies only in the area affected by the Subzone)	Overlay (applies only in the area affected by the Overlay)
Demolition within an Historic Areas Overlay area or State Heritage Area	None	None	None	Historic Areas: All State Heritage Area: All
Dwelling addition	[Building Height] PO 2.1 [Primary Street Setback 3.1] PO 3.1 [Secondary Street Setback] PO 4.1 [Side Boundary Setback] PO 5.1 [Rear Boundary Setback] PO 6.1 [Site Dimensions and Land Division]: PO 8.1 [Site Coverage]: PO 9.1	Clearance from Overhead Powerlines: PO 1.1 Infrastructure and Renewable Energy Facilities [Water Supply]: PO 11.2 Infrastructure and Renewable Energy Facilities [Wastewater Services]: PO 12.1, 12.2 Design in Urban Areas [All Residential Development – External Appearance]: PO 14.1 Design in Urban Areas [All Residential Development – Outlook and Amenity]: PO 15.1 Design in Urban Areas [All Residential Development – 3 Building Levels or Less – External Appearance]: PO 19.1, 19.2, 19.3 Design in Urban Areas [All Residential Development – 3 Building Levels or Less –Overlooking / Visual Privacy]: PO 20.1 Design in Urban Areas [All Residential Development – 3 Building Levels or Less –Private Open Space]: PO 21.1, 21.2, 21.3 Design in Urban Areas [All Residential Development – 3 Building Levels or Less –Landscaping]: PO 22.1, 22.2 Design in Urban Areas [All Residential Development – 3 Building Levels or Less – Waste Storage]: PO 25.1 Interface Between Land Uses [Overshadowing]: PO 3.1, 3.2 Interface Between Land Uses [Activities Generating Noise or Vibration]: PO 4.4 Site Contamination: PO 1.1		Airport Building Heights (Aircraft Landing Area) Overlay :All Airport Building Heights (Regulated) Overlay :All Building Near Airfields Overlay :All Character Area Overlay :All Character Preservation District Overlay: All Defence Aviation Area Overlay: All Future Road Widening Overlay: All Hazards (Bushfire – High Risk) Overlay: All Hazards (Bushfire - Medium Risk) Overlay: All Hazards (Bushfire - General Risk) Overlay: All Hazards (Bushfire - Regional) Overlay: All Hazards (Flooding) Overlay: All Historic Area Overlay: All Key Railway Crossings Overlay: All Local Heritage Place Overlay: All Major Urban Transport Routes Overlay : All Mt Lofty Ranges Catchment (Area 1) Overlay: All Mt Lofty Ranges Catchment (Area 2) Overlay: All Murray Darling Basin Overlay: All Native Vegetation Overlay: All Noise and Air Emissions Overlay: All Non-stop Corridor Overlay: All Prescribed Water Resources Area Overlay: All Ramsar Wetlands Overlay: All Regulated Trees Overlay: All River Murray Flood Plain Overlay: All River Murray Tributaries Area Overlay: All Sloping Land Overlay: All State Heritage Area Overlay: All State Heritage Place Overlay: All State Significant Native Vegetation Overlay: All Urban Transport Routes Overlay: All Water Resources Overlay: All

Class of Development	Applicable Policies			
	Zone	General Development Policies	Subzone (applies only in the area affected by the Subzone)	Overlay (applies only in the area affected by the Overlay)
Detached Dwelling	<p>[Building Height] PO 2.1</p> <p>[Primary Street Setback 3.1] PO 3.1</p> <p>[Secondary Street Setback] PO 4.1</p> <p>[Side Boundary Setback] PO 5.1</p> <p>[Rear Boundary Setback] PO 6.1</p> <p>[Site Dimensions and Land Division]: PO 8.1</p> <p>[Site Coverage]: PO 9.1</p>	<p>Clearance from Overhead Powerlines: PO 1.1</p> <p>Infrastructure and Renewable Energy Facilities [Water Supply]: PO 11.2</p> <p>Infrastructure and Renewable Energy Facilities [Wastewater Services]: PO 12.1, 12.2</p> <p>Transport, Access and Parking [Vehicle Access]: PO 3.1, 3.5, 3.6</p> <p>Transport, Access and Parking [Vehicle Parking Rates]: PO 5.1</p> <p>Design in Urban Areas [All Development – Car Parking Appearance]: PO 6.1</p> <p>Design in Urban Areas [All Residential Development – External Appearance]: PO 14.1, 14.2</p> <p>Design in Urban Areas [All Residential Development – Outlook and Amenity]: PO 15.1</p> <p>Design in Urban Areas [All Residential Development – Access and Servicing]: PO 16.1</p> <p>Design in Urban Areas [All Residential Development – Flooding]: PO 18.1</p> <p>Design in Urban Areas [All Residential Development – 3 Building Levels or Less – External Appearance]: PO 19.1, 19.2, 19.3</p> <p>Design in Urban Areas [All Residential Development – 3 Building Levels or Less –Overlooking / Visual Privacy]: PO 20.1</p> <p>Design in Urban Areas [All Residential Development – 3 Building Levels or Less –Private Open Space]: PO 21.1, 21.2</p>		<p>Affordable Housing Overlay: All</p> <p>Airport Building Heights (Aircraft Landing Area) Overlay :All</p> <p>Airport Building Heights (Regulated) Overlay :All</p> <p>Building Near Airfields Overlay :All</p> <p>Character Area Overlay :All</p> <p>Character Preservation District Overlay: All</p> <p>Defence Aviation Area Overlay: All</p> <p>Future Road Widening Overlay: All</p> <p>Hazards (Bushfire – High Risk) Overlay: All</p> <p>Hazards (Bushfire - Medium Risk) Overlay: All</p> <p>Hazards (Bushfire - General Risk) Overlay: All</p> <p>Hazards (Bushfire - Regional) Overlay: All</p> <p>Hazards (Flooding) Overlay: All</p> <p>Historic Area Overlay: All</p> <p>Key Railway Crossings Overlay: All</p> <p>Local Heritage Place Overlay: All</p> <p>Major Urban Transport Routes Overlay : All</p> <p>Mt Lofty Ranges Catchment (Area 1) Overlay: All</p> <p>Mt Lofty Ranges Catchment (Area 2) Overlay: All</p> <p>Murray Darling Basin Overlay: All</p> <p>Native Vegetation Overlay: All</p> <p>Noise and Air Emissions Overlay: All</p> <p>Non-stop Corridor Overlay: All</p> <p>Prescribed Water Resources Area Overlay: All</p> <p>Ramsar Wetlands Overlay: All</p> <p>Regulated Trees Overlay: All</p> <p>River Murray Flood Plain Overlay: All</p> <p>River Murray Tributaries Area Overlay: All</p> <p>Sloping Land Overlay: All</p> <p>State Heritage Area Overlay: All</p> <p>State Heritage Place Overlay: All</p> <p>State Significant Native Vegetation Overlay: All</p> <p>Urban Transport Routes Overlay: All</p> <p>Water Resources Overlay: All</p>

Class of Development	Applicable Policies			
	Zone	General Development Policies	Subzone (applies only in the area affected by the Subzone)	Overlay (applies only in the area affected by the Overlay)
		<p>Design in Urban Areas [All Residential Development – 3 Building Levels or Less –Landscaping]: PO 22.1, 22.2</p> <p>Design in Urban Areas [All Residential Development – 3 Building Levels or Less – Water Sensitive Design]: PO 23.1, 23.2, 23.3</p> <p>Design in Urban Areas [All Residential Development – 3 Building Levels or Less – Car Parking and Manoeuvrability]: PO 24.1, 24.2, 24.3, 24.4, 24.5, 24.6</p> <p>Design in Urban Areas [All Residential Development – 3 Building Levels or Less – Waste Storage]: PO 25.1</p> <p>Interface Between Land Uses [Overshadowing]: PO 3.1, 3.2</p> <p>Interface Between Land Uses [Interface Between Rural Activities]: PO 9.3, 9.4, 9.5</p> <p>Interface Between Land Uses [Interface with Mines and Quarries (Rural and Remote Areas): PO 10.1</p> <p>Site Contamination: PO 1.1</p>		
Excavation and filling		Design in Urban Areas [All Development – Fences and Walls]: PO 8.2		
Fence		Design in Urban Areas [All Development – Fences and Walls]: PO 8.1	None	Airport Building Heights (Aircraft Landing Area) Overlay :All Airport Building Heights (Regulated) Overlay :All Building Near Airfields Overlay :All Character Area Overlay :All Character Preservation District Overlay: All Defence Aviation Area Overlay: All Future Road Widening Overlay: All Hazards (Bushfire – High Risk) Overlay: All Hazards (Bushfire - Medium Risk) Overlay: All Hazards (Bushfire - General Risk) Overlay: All Hazards (Bushfire - Regional) Overlay: All Hazards (Flooding) Overlay: All Historic Area Overlay: All

Class of Development	Applicable Policies			
	Zone	General Development Policies	Subzone (applies only in the area affected by the Subzone)	Overlay (applies only in the area affected by the Overlay)
				Key Railway Crossings Overlay: All Local Heritage Place Overlay: All Major Urban Transport Routes Overlay : All Mt Lofty Ranges Catchment (Area 1) Overlay: All Mt Lofty Ranges Catchment (Area 2) Overlay: All Murray Darling Basin Overlay: All Native Vegetation Overlay: All Noise and Air Emissions Overlay: All Non-stop Corridor Overlay: All Prescribed Water Resources Area Overlay: All Ramsar Wetlands Overlay: All Regulated Trees Overlay: All River Murray Flood Plain Overlay: All River Murray Tributaries Area Overlay: All Sloping Land Overlay: All State Heritage Area Overlay: All State Heritage Place Overlay: All State Significant Native Vegetation Overlay: All Urban Transport Routes Overlay: All Water Resources Overlay: All
Land division	[Site Dimensions and Land Division]: PO 8.1	Land Division in Urban Areas: All	None	Affordable Housing Overlay: All Airport Building Heights (Aircraft Landing Area) Overlay: All Airport Building Heights (Regulated) Overlay: All Building Near Airfields Overlay : All Character Area Overlay: All Character Preservation District Overlay: All Defence Aviation Area Overlay: All Environment and Food Production Area Overlay: All Future Road Widening Overlay: All Hazards (Bushfire – High Risk) Overlay: All Hazards (Bushfire - Medium Risk) Overlay: All Hazards (Bushfire - General Risk) Overlay: All Hazards (Bushfire - Regional) Overlay: All Hazards (Flooding) Overlay: All Historic Area Overlay: All Key Railway Crossings Overlay: All Local Heritage Place Overlay: All Major Urban Transport Routes Overlay : All Mt Lofty Ranges Catchment (Area 1) Overlay: All

Class of Development	Applicable Policies			
	Zone	General Development Policies	Subzone (applies only in the area affected by the Subzone)	Overlay (applies only in the area affected by the Overlay)
				Mt Lofty Ranges Catchment (Area 2) Overlay: All Murray Darling Basin Overlay: All Native Vegetation Overlay: All Noise and Air Emissions Overlay: All Non-stop Corridor Overlay: All Prescribed Water Resources Area Overlay: All Prescribed Wells Area Overlay: All Ramsar Wetlands Overlay: All Regulated Trees Overlay: All River Murray Flood Plain Overlay: All River Murray Tributaries Area Overlay: All Sloping Land Overlay: All State Heritage Area Overlay: All State Heritage Place Overlay: All State Significant Native Vegetation Overlay: All Strategic Infrastructure (Gas Pipelines) Overlay: All Traffic Generating Development Overlay: All Urban Transport Routes Overlay: All Water Resources Overlay: All
Tree damaging activity				Regulated Trees Overlay: All
All other Code Assessed Development	All	All	None	Any Relevant Overlay: All.

Table 4 – Restricted Development Classification

Class of Development The following Classes of Development are classified as Restricted subject to any 'Exclusions'	Exclusions
Shop	Restaurant With a gross leasable area less than 200m².

Assessment Criteria (AC)

Desired Outcome (DO)

DO 1

Low or very low density housing within low rise buildings, often together with large outbuildings. Easy access and parking for cars. Considerable space for trees and other vegetation around buildings, as well as on-site wastewater treatment where necessary. Limited goods, services and facilities that enhance rather than compromise rural residential amenity.

Performance Outcomes and Deemed to Satisfy / Designated Performance Outcome Criteria

Land Use

PO 1.1

Residential development and supporting uses that are consistent with a spacious and peaceful lifestyle for individual households.

DTS/DPF 1.1

Development comprises one or more of the following land uses:

Ancillary accommodation

Community facility

Dwelling

Educational establishment

Office

Outbuilding

Pre-school

Recreation area

Residential flat building

Retirement facility

Shop

Supported accommodation.

PO 1.2

Shops, consulting rooms and offices of a scale to maintain the amenity of nearby residents.

DTS/DPF 1.2

Other than a change in the use of an existing building that has been lawfully used as a shop, office or consulting room (or any combination thereof), shops, offices and consulting rooms do not exceed 50m² in gross leasable floor area (individually or combined).

PO 1.3

Non-residential development compatible with a residential character and amenity.

DTS/DPF 1.3

None are applicable.

Building Height

PO 2.1

Buildings contribute to a low-rise residential character and complement the height of nearby buildings.

DTS/DPF 2.1

Building height (excluding garages, carports and outbuildings) no greater than:

- (a) 2 building levels and 9m from the top of the footings; and
- (b) wall height that is no greater than 7m from the top of the footings, except in the case of a gable end.

Primary Street Setback

PO 3.1

Buildings that are set back from primary street boundaries to complement existing streetscape character and provide space for vegetation.

DTS 3.1

Buildings are set back from the primary street boundaries at least:

- (a) the average of existing buildings on the adjoining sites which face the same street;
- (b) in relation to a site on the corner of two streets or adjacent a public space or thoroughfare, at least the distance of existing buildings on the adjacent site or the closest site away from the corner, public space or thoroughfare that contains a building facing the same primary street without crossing another street, public space or thoroughfare; or
- (c) 10m where no building exists on one or both of the adjoining sites which face the same street.

Secondary Street Setback

PO 4.1

Buildings are set back from secondary street boundaries to maintain a pattern of separation between building walls and public thoroughfares and reinforce a streetscape character.

DTS 4.1

Buildings are set back at least 4m from the boundary of the allotment with the secondary street frontage, or if a dwelling on any adjoining allotment is closer to the secondary street than 4m, the distance of that dwelling from the boundary with the secondary street (being, if relevant, the lesser of the 2 distances).

Side Boundary Setback

PO 5.1

Buildings are set back from side boundaries to allow maintenance and access around buildings and minimise impacts on adjoining properties.

DTS 5.1

Buildings are set back from the side boundaries at least 2m.

Rear Boundary Setback

PO 6.1

Buildings that are set back from rear boundaries to provide:

- (a) separation between dwellings in a way that complements the established character of the locality;
- (b) access to natural light and ventilation for neighbours;
- (c) open space recreational opportunities; and

- (d) space for landscaping and vegetation.

DTS 6.1

Buildings are set back from the rear boundary at least 6m.

Ancillary Buildings and Structures

PO 7.1

Residential ancillary buildings and structures sited and designed to not detract from the streetscape or appearance of buildings on the site or neighbouring properties.

DTS 7.1

Ancillary buildings and structures:

- (a) are ancillary to a dwelling erected on the site;
- (b) are not being constructed, added to or altered so that any part is situated:
 - (i) in front of any part of the building line of the dwelling to which it is ancillary; or
 - (ii) within 4m of a boundary of the allotment with a secondary street (if the land has boundaries on two or more roads); or
 - (iii) within 2m of a side boundary;
- (c) in the case of a garage or carport, has a primary street setback that is at least as far back as the dwelling;
- (d) not exceed 10m or 50% of the site frontage (whichever is the lesser) when facing a primary street or secondary street;
- (e) have a wall height or post height not exceeding 4m above natural ground level;
- (f) have a roof height where no part of the roof is more than 5m above the natural ground level; and
- (g) if clad in sheet metal, is pre-colour treated or painted in a non-reflective colour.

PO 7.2

Ancillary buildings and structures do not impede on-site functional requirements such as private open space provision, car parking requirements or result in over-development of the site.

DTS/DPF 7.2

Ancillary buildings and structures do not result in:

- (a) less private open space than specified in Residential Liveability Table 1 - Private Open Space;
- (b) less on-site car parking than specified in Transport, Access and Parking Table 1 - Off-street Car Parking Requirements; and
- (c) the total roofed floor area of all existing or proposed ancillary building(s) or structure(s) exceeding 100m².

Site Dimensions and Land Division

PO 8.1

Allotments/sites created for residential purposes that are of suitable size and dimension to contribute to a pattern of development consistent to the locality.

DTS/DPF 8.1

Development accords with the following:

- (a) for sites connected to mains sewer or Community Wastewater Management System, site areas (or allotment areas in the case of land division) are not less than the minimum allotment area specified in the Minimum Allotment Size Technical and Numeric Variation Overlay;

- (b) for sites without connection to mains sewer or Community Wastewater Management System, site areas (or allotment areas in the case of land division) are not less than the greater of:
 - i. 1200m²; or
 - ii. the minimum allotment area specified in the Minimum Allotment Size Technical and Numeric Variation Overlay; and
- (c) site frontages not less than 20m.

Site Coverage

PO 9.1

Building footprints consistent with a low-density residential character and provide sufficient space around buildings to limit visual impact, provide an attractive outlook and access to light and ventilation.

DTS/DPF 9.1

The development will not result in a total roofed area (excluding eaves of a dwelling) on the site exceeding 60%.

External Appearance of Group Dwellings, Residential Flat Buildings and Battle-axe Development

PO 10.1

Residential flat buildings are of an appropriate scale with larger buildings divided and separated into smaller forms to:

- (a) achieve a mass and scale that better relates to a low-rise suburban character;
- (b) limit visual impact and provide appropriate outlook for occupants; and
- (c) provide adequate space around buildings for light, ventilation and landscaping.

DTS/DPF 24.1

Residential Flat Buildings that are 2 or more storeys:

- (a) have a building depth or length no greater than 20m; and
- (b) are setback at least 4m from other dwellings or other residential flat buildings.

PO 10.2

Services including gas and water meters conveniently located and screened from public view.

DTS/DPF 10.2

None are applicable.

Concept Plans

PO 11.1

Development is compatible with the outcomes sought by any relevant Concept Plan contained within the Concept Plans Technical and Numeric Variation Overlay.

DTS/DPF 11.1

None are applicable.

Procedural Matters (PM)

Notification of Performance assessed development

All classes of performance assessed development are excluded from notification except where they involve any of the following:

- (a) the site of the development is adjacent land to land in a different zone;
- (b) development identified as "all other code assessed development" in Residential Neighbourhood Zone Table 3;
- (c) more than one dwelling per allotment;
- (d) building exceeding 2 building levels (over 9m) in height;
- (e) Development involving the creation of four or more additional dwellings;
- (f) Shop, office or consulting room greater than 250m² in floor area (individually or combined) where located on a collector or higher order road;
- (g) Shop, office or consulting room greater than 100m² in floor area and provided it is not located adjacent to an existing commercial activity; or
- (h) dwellings that do not satisfy DTS/DPF 2.1, 3.1, 4.1, 5.1, and 6.1
- (i) Any development that is classified (either partly or wholly) as 'All other development' in the Assessment Table.

Placement of Notices – Exemptions for Performance Assessed Development

None specified.

Placement of Notices – Exemptions for Restricted Development

None specified.

Rural Zone

Table 1 – Accepted Development Classification

Class of Development The following Classes of Development are classified as Accepted Development subject to meeting the 'Accepted Development Classification Criteria'	Accepted Development Classification Criteria
Building work on railway land	<ol style="list-style-type: none"> 1 Building work is associated with a railway 2 It is situated (or to be situated) on railway land 3 It is required for the conduct or maintenance of railway activities.
Carport Except where any of the following apply: <ul style="list-style-type: none"> • Character Preservation District Overlay • Coastal Areas Overlay • Hazards (Acid Sulfate Soils) Overlay • Hazards (Flooding) Overlay • Historic Area Overlay • Historic Shipwrecks Overlay • Local Heritage Place Overlay • State Heritage Area Overlay • State Heritage Place Overlay • Native Vegetation Overlay • State Significant Native Vegetation Overlay • Significant Landscape Protection Overlay • Ramsar Wetlands Overlay • River Murray Flood Plain Overlay 	<ol style="list-style-type: none"> 1 The development will not be built, or encroach, on an area that is, or will be, required for a sewerage system or waste control system 2 It is ancillary to a dwelling erected on the site 3 Primary street setback – at least 5.5m from the primary street boundary and as far back as the building line of the building to which it is ancillary 4 Secondary street setback – at least 900mm from the boundary of the allotment (if the land has boundaries on two or more roads) 5 Total floor area - does not exceed 60m² 6 Post height - does not exceed 3m measured from natural ground level (and not including a gable end) 7 Building height - does not exceed 5m 8 If situated on or abutting a boundary (not being a boundary with a primary street or secondary street) – a length not exceeding 10m unless: <ol style="list-style-type: none"> (a) a longer wall or structure exists on the adjacent site and is situated on the same allotment boundary; and (b) the proposed wall or structure will be built along the same length of boundary as the existing adjacent wall or structure to the same or lesser extent 9 If the carport abuts or is situated on the boundary of the allotment (not being a boundary with a primary street or secondary street):

Class of Development The following Classes of Development are classified as Accepted Development subject to meeting the 'Accepted Development Classification Criteria'	Accepted Development Classification Criteria
<ul style="list-style-type: none"> • Sloping Land Overlay • Future Road Widening Overlay where an existing access is altered or a new access is created • Key Railway Crossings Overlay where an existing access is altered or a new access is created • Key Outback and Rural Routes Overlay where an existing access is altered or a new access is created • Major Urban Transport Routes Overlay where an existing access is altered or a new access is created • Non-stop Corridor Overlay where an existing access is altered or a new access is created • Urban Transport Routes Overlay where an existing access is altered or a new access is created • Water Resources Overlay 	<ul style="list-style-type: none"> (a) it will not result in all relevant walls or structures located along the boundary exceeding 45% of the length of the boundary; and (b) it will not be located within 3m of any other wall along the same boundary unless on an adjacent site on that boundary there is an existing wall of a building that would be adjacent to or abut the proposed wall or structure <p>10 Door opening for vehicle access – does not exceed, in total, 7m in width or 50% of the width of the allotment frontage (whichever lesser)</p> <p>11 Internal dimensions – does not exceed 3.2m in width and 6m in length between all fences, walls and doors</p> <p>12 The carport:</p> <ul style="list-style-type: none"> (a) is located so that vehicle access: <ul style="list-style-type: none"> i. is provided via a lawfully existing or authorised driveway or access point or an access point for which consent has been granted as part of an application for the division of land; or ii. will use a driveway that: <ul style="list-style-type: none"> A. is not located within 6 metres of an intersection of 2 or more roads or a pedestrian actuated crossing; and B. will not interfere with an item of street furniture (including directional signs, lighting, seating and weather shelters), other infrastructure, or a tree; or iii. if adjacent a kerbed road, will be via a kerb that is designed to allow a vehicle to roll over it; and (b) is located so that the gradient from the place of access on the boundary of the allotment to the finished floor level at the front of the carport when the work is completed is not steeper than 1:4 on average; and (c) The centre of the driveway at the public road boundary is no more than 25 degree deviation from the centre of the front of the covered car parking space for which it provides vehicle access

Class of Development

The following Classes of Development are classified as Accepted Development subject to meeting the 'Accepted Development Classification Criteria'

Accepted Development Classification Criteria

Demolition

Except where any of the following apply:

- Historic Area Overlay
- Historic Shipwreck identified in the Historic Shipwrecks Overlay
- Local Heritage Place identified in the Local Heritage Place Overlay
- State Heritage Area Overlay
- State Heritage Place identified in the State Heritage Place Overlay

None.

Farming

- 1 There is no excavation or filling of land
- 2 Does not involve the erection, construction or alteration of, or addition to, any building or structure
- 3 Does not involve the clearance of native vegetation

Internal building work

Except where any of the following apply:

- Historic Shipwreck identified in the Historic Shipwrecks Overlay
- Local Heritage Place identified in the Local Heritage Place Overlay
- State Heritage Area Overlay

- 1 There will be no increase in the total floor area of the building
- 2 There will be no alteration to the external appearance of the building.

Class of Development

The following Classes of Development are classified as Accepted Development subject to meeting the 'Accepted Development Classification Criteria'

Accepted Development Classification Criteria

- State Heritage Place identified in the State Heritage Place Overlay

Outbuilding (in the form of a garage)

Except where any of the following apply:

- Building Near Airfields Overlay
- Character Preservation District Overlay
- Coastal Areas Overlay
- Hazards (Acid Sulfate Soils) Overlay
- Hazards (Flooding) Overlay
- Historic Area Overlay
- Historic Shipwrecks Overlay
- Local Heritage Place Overlay
- State Heritage Area Overlay
- State Heritage Place Overlay
- Native Vegetation Overlay
- State Significant Native Vegetation Overlay
- Significant Landscape Protection Overlay
- Ramsar Wetlands Overlay
- River Murray Flood Plain Overlay
- Sloping Land Overlay
- Future Road Widening Overlay where an existing access is altered or a new access is created

- 1 The development will not be built, or encroach, on an area that is, or will be, required for a sewerage system or waste control system
- 2 It is detached from and ancillary to a dwelling erected on the site.
- 3 Primary street setback – at least 5.5m from the primary street boundary and as far back as the building line of the building to which it is ancillary
- 4 Secondary street setback – at least 900mm from the boundary of the allotment (if the land has boundaries on two or more roads)
- 5 Total floor area - does not exceed 60m²
- 6 Wall height - does not exceed 3m measured from natural ground level (and not including a gable end)
- 7 Building height - does not exceed 5m
- 8 If situated on or abutting a boundary (not being a boundary with a primary street or secondary street) – a length not exceeding 10m unless:
 - (a) a longer wall or structure exists on the adjacent site and is situated on the same allotment boundary; and
 - (b) the proposed wall or structure will be built along the same length of boundary as the existing adjacent wall or structure to the same or lesser extent
- 9 If the outbuilding abuts or is situated on the boundary of the allotment (not being a boundary with a primary street or secondary street):
 - (a) it will not result in all relevant walls or structures located along the boundary exceeding 45% of the length of the boundary; and
 - (b) it will not be located within 3m of any other wall along the same boundary unless on an adjacent site on that boundary there is an existing wall of a building that would be adjacent to or abut the proposed wall or structure
- 10 Internal dimensions – exceed 3.2m in width and 6m in length between all walls and doors

Class of Development The following Classes of Development are classified as Accepted Development subject to meeting the 'Accepted Development Classification Criteria'	Accepted Development Classification Criteria
<ul style="list-style-type: none"> • Key Railway Crossings Overlay where an existing access is altered or a new access is created • Key Outback and Rural Routes Overlay where an existing access is altered or a new access is created • Major Urban Transport Routes Overlay where an existing access is altered or a new access is created • Non-stop Corridor Overlay where an existing access is altered or a new access is created • Urban Transport Routes Overlay where an existing access is altered or a new access is created • Water Resources Overlay 	<p>11 Door opening for vehicle access – does not exceed, in total, 7m in width or 50% of the width of the allotment frontage (whichever lesser)</p> <p>12 The garage:</p> <p>(a) is located so that vehicle access:</p> <ul style="list-style-type: none"> i. is provided via a lawfully existing or authorised driveway or access point or an access point for which consent has been granted as part of an application for the division of land; or ii. will use a driveway that: <ul style="list-style-type: none"> A. is not located within 6 metres of an intersection of 2 or more roads or a pedestrian actuated crossing; and B. will not interfere with an item of street furniture (including directional signs, lighting, seating and weather shelters), other infrastructure, or a tree; or iii. if adjacent a kerbed road, will be via a kerb that is designed to allow a vehicle to roll over it; and <p>(b) is located so that the gradient from the place of access on the boundary of the allotment to the finished floor level at the front of the carport when the work is completed is not steeper than 1:4 on average; and</p> <p>(c) The centre of the driveway at the public road boundary is no more than 25 degree deviation from the centre of the front of the covered car parking space for which it provides vehicle access</p> <p>13 If clad in sheet metal—is pre-colour treated or painted in a non-reflective colour.</p>
<p>Outbuilding (not being a garage)</p> <p>Except where any of the following apply:</p> <ul style="list-style-type: none"> • Character Preservation District Overlay • Coastal Areas Overlay 	<ol style="list-style-type: none"> 1 The development will not be built, or encroach, on an area that is, or will be, required for a sewerage system or waste control system 2 It is detached from and ancillary to a dwelling erected on the site 3 Primary street setback – at least as far back as the building line of the building to which it is ancillary

Class of Development The following Classes of Development are classified as Accepted Development subject to meeting the 'Accepted Development Classification Criteria'	Accepted Development Classification Criteria
<ul style="list-style-type: none"> • Hazards (Acid Sulfate Soils) Overlay • Hazards (Flooding) Overlay • Historic Area Overlay • Historic Shipwrecks Overlay • Local Heritage Place Overlay • State Heritage Area Overlay • State Heritage Place Overlay • Native Vegetation Overlay • State Significant Native Vegetation Overlay • Significant Landscape Protection Overlay • Ramsar Wetlands Overlay • River Murray Flood Plain Overlay • Sloping Land Overlay • Water Resources Overlay 	<ol style="list-style-type: none"> 4 Secondary street setback – at least 900mm from the boundary of the allotment (if the land has boundaries on two or more roads) 5 Side boundary setbacks – at least 900mm from the boundary of the allotment 6 Total floor area does not exceed 60m² 7 Wall height - does not exceed 3m measured from natural ground level (and not including a gable end) 8 Building height - does not exceed 5m 9 If situated on or abutting a boundary (not being a boundary with a primary street or secondary street) – a length not exceeding 10m unless: <ol style="list-style-type: none"> (a) a longer wall or structure exists on the adjacent site and is situated on the same allotment boundary; and (b) the proposed wall or structure will be built along the same length of boundary as the existing adjacent wall or structure to the same or lesser extent 10 If the outbuilding abuts or is situated on the boundary of the allotment (not being a boundary with a primary street or secondary street): <ol style="list-style-type: none"> (a) it will not result in all relevant walls or structures located along the boundary exceeding 45% of the length of the boundary; and (b) will not be located within 3m of any other wall along the same boundary unless on an adjacent site on that boundary there is an existing wall of a building that would be adjacent to or abut the proposed wall or structure 11 If clad in sheet metal—is pre-colour treated or painted in a non-reflective colour.
<p>Private bushfire shelters</p> <p>Except where any of the following apply:</p> <ul style="list-style-type: none"> • Character Preservation District Overlay • Coastal Areas Overlay 	<ol style="list-style-type: none"> 1 The development will not be built, or encroach, on an area that is, or will be, required for a sewerage system or waste control system 2 Primary street setback – at least as far back as the building to which it is ancillary 3 Secondary street setback – at least 900mm from the boundary of the allotment 4 At least 6m from the corner of an allotment which abuts the intersection of two or more roads (other than where a 4m x 4m allotment cut-off is already in place).

Class of Development

The following Classes of Development are classified as Accepted Development subject to meeting the 'Accepted Development Classification Criteria'

Accepted Development Classification Criteria

- Hazards (Acid Sulfate Soils) Overlay
- Hazards (Flooding) Overlay
- Historic Area Overlay
- Historic Shipwrecks Overlay
- Local Heritage Place Overlay
- State Heritage Area Overlay
- State Heritage Place Overlay
- Native Vegetation Overlay
- State Significant Native Vegetation Overlay
- Significant Landscape Protection Overlay
- Ramsar Wetlands Overlay
- River Murray Flood Plain Overlay
- Sloping Land Overlay
- Water Resources Overlay

Protective tree netting structure

Except where any of the following apply:

- Coastal Areas Overlay
- Hazards (Acid Sulfate Soils) Overlay
- Historic Area Overlay
- Historic Shipwrecks Overlay
- Local Heritage Place Overlay
- State Heritage Area Overlay
- State Heritage Place Overlay

- 1 The development will not be built, or encroach, on an area that is, or will be, required for a sewerage system or waste control system
- 2 No part of the protective tree netting structure will be more than 6m above natural ground level (depending on where it is situated)
- 3 Netting visible from the outside of the protective tree netting structure is of a low light-reflective nature, and, in the case of a structure that has side netting, the side netting is of a dark colour
- 4 In the case of a development on a site that is within a Hazards (Bushfire - Outback) Overlay, Hazards (Bushfire – Regional) Overlay, Hazards (Bushfire - General Risk) Overlay, Hazards (Bushfire Medium - Risk) Overlay or Hazards (Bushfire - High Risk) Overlay, the protective tree netting structure provides for access to the site in accordance with the following:

Class of Development

The following Classes of Development are classified as Accepted Development subject to meeting the 'Accepted Development Classification Criteria'

- State Significant Native Vegetation Overlay
- Significant Landscape Protection Overlay
- Ramsar Wetlands Overlay
- River Murray Flood Plain Overlay
- Sloping Land Overlay
- Water Protection Area Overlay
- Water Resources Overlay

Accepted Development Classification Criteria

- (a) no part of the protective tree netting structure (including cables and points of attachment of cables (known as "auger" or "anchor" points) will be within 5m of any boundary of the site; or
- (b) does not prevent access or movement of vehicles of 4m height and 3.5m width (or less) on any access road or track (including fire tracks) on the site
- 5 No part of the netting canopy of the protective tree netting structure:
 - (a) will cover native vegetation; or
 - (b) will be within 5m of a road (including any road reserve)
- 6 The points of attachment of any cables will not be located:
 - (a) outside the boundaries of the site; or
 - (b) within a watercourse (within the meaning of the Natural Resources Management Act 2004)
- 7 In relation to a dwelling located on an allotment adjoining the site on which the protective tree netting structure is located, the protective tree netting structure complies with the following:
 - (a) if the netting canopy nearest the dwelling on the adjoining allotment is 4m or less above ground level (depending on where it is situated), no part of the netting canopy is within 10m of the dwelling
 - (b) in any other case, no part of the netting canopy is within 15m of the dwelling.

Shade sail

Except where any of the following apply:

- Character Preservation District Overlay
- Coastal Areas Overlay
- Hazards (Acid Sulfate Soils) Overlay

- 1 The development will not be built, or encroach, on an area that is, or will be, required for a sewerage system or waste control system
- 2 Shade sail consists of permeable material
- 3 The total area of the sail - does not exceed 40m²
- 4 No part of the shade sail will be:
 - (a) 3m above ground or floor level (depending on where it is situated) at any place within 900mm of a boundary of the allotment

Class of Development

The following Classes of Development are classified as Accepted Development subject to meeting the 'Accepted Development Classification Criteria'

Accepted Development Classification Criteria

- Historic Area Overlay
- Historic Shipwrecks Overlay
- Local Heritage Place Overlay
- State Heritage Area Overlay
- State Heritage Place Overlay
- Native Vegetation Overlay
- State Significant Native Vegetation Overlay
- Significant Landscape Protection Overlay
- Ramsar Wetlands Overlay
- River Murray Flood Plain Overlay
- Sloping Land Overlay
- Water Resources Overlay

- (b) 5m above ground or floor level (depending on where it is situated) within any other part of the allotment
- 5 Primary street setback – at least as far back as the building line of the building to which it is ancillary
- 6 If any part of the sail will be situated on a boundary of the allotment, the length of sail along a boundary does not exceed 8m
- 7 In a case where any part of the sail or a supporting structure will be situated on a side boundary of the allotment — the length of the sail and any such supporting structure together with all relevant walls or structures located along the boundary will not exceed 45% of the length of the boundary.

Solar photovoltaic panels (roof mounted)

Except where any of the following apply:

- Historic Area Overlay
- Local Heritage Place identified in the Local Heritage Place Overlay
- State Heritage Area Overlay
- State Heritage Place identified in the State Heritage Place Overlay

- 1 Panels are installed parallel to the roof of a building and with the underside surface of the panel not being more than 100mm above the surface of the roof
- 2 Panels and associated components do not overhang any part of the roof
- 3 Does not apply to system with a generating capacity of more than 5MW that is to be connected to the State's power system.

Solar photovoltaic panels (ground mounted)

- 5 The system is freestanding rather than attached to a building or other structure.
- 6 No part of the system:

Class of Development

The following Classes of Development are classified as Accepted Development subject to meeting the 'Accepted Development Classification Criteria'

Accepted Development Classification Criteria

Except where any of the following apply:

- Character Preservation District Overlay
- Historic Area Overlay
- Local Heritage Place identified in the Local Heritage Place Overlay
- State Heritage Area Overlay
- State Heritage Place identified in the State Heritage Place Overlay
- State Significant Native Vegetation Overlay

- (b) is more than 4 metres in height (measured as a height above the natural surface of the ground);
 - (c) is within 100 metres of a dwelling not associated with the system (whether the dwelling is on the same allotment as the system or another allotment); and
 - (d) is within 10 metres of a boundary of an allotment containing a dwelling not associated with the system.
- 7 The generating capacity of the system does not exceed 30 kW
 - 8 Does not result in the clearance of any native vegetation.

Spa pool

Swimming pool

Except where any of the following apply:

- Character Preservation District Overlay
- Coastal Areas Overlay
- Hazards (Acid Sulfate Soils) Overlay
- Hazards (Flooding) Overlay
- Historic Area Overlay
- Local Heritage Place Overlay
- State Heritage Area Overlay
- State Heritage Place Overlay
- Native Vegetation Overlay

- 1 The development will not be built, or encroach, on an area that is, or will be, required for a sewerage system or waste control system
- 2 It is ancillary to a dwelling erected on the site
- 3 Allotment boundary setback – not less than 1m
- 4 Primary street setback – at least as far back as the building line of the building to which it is ancillary
- 5 Location of filtration system from a dwelling on an adjoining allotment:
 - (a) not less than 5m where the filtration system is located inside a solid structure that will have material impact on the transmission of noise
 - (b) not less than 12m in any other case.

Class of Development

The following Classes of Development are classified as Accepted Development subject to meeting the 'Accepted Development Classification Criteria'

Accepted Development Classification Criteria

- State Significant Native Vegetation Overlay
- Significant Landscape Protection Overlay
- Ramsar Wetlands Overlay
- River Murray Flood Plain Overlay
- Sloping Land Overlay
- Water Resources Overlay

Verandah

Except where any of the following apply:

- Character Preservation District Overlay
- Coastal Areas Overlay
- Hazards (Acid Sulfate Soils) Overlay
- Hazards (Flooding) Overlay
- Historic Area Overlay
- Local Heritage Place Overlay
- State Heritage Area Overlay
- State Heritage Place Overlay
- Native Vegetation Overlay
- State Significant Native Vegetation Overlay
- Significant Landscape Protection Overlay
- Ramsar Wetlands Overlay
- River Murray Flood Plain Overlay

- 1 The development will not be built, or encroach, on an area that is, or will be, required for a sewerage system or waste control system
- 2 It is ancillary to a dwelling erected on the site
- 3 Primary street setback – as far back as the building line of the building to which it is ancillary
- 4 Total floor area - does not exceed 60m²
- 5 Post height - does not exceed 3m measured from natural ground level
- 6 Building height - does not exceed 5m
- 7 Length - does not exceed 10m if any part of the structure abuts or is situated on a boundary of the allotment

Class of Development

The following Classes of Development are classified as Accepted Development subject to meeting the 'Accepted Development Classification Criteria'

Accepted Development Classification Criteria

Water Resources Overlay

Water tank (above ground)

Except where any of the following apply:

- Character Preservation District Overlay
- Coastal Areas Overlay
- Hazards (Flooding) Overlay
- Historic Area Overlay
- Local Heritage Place Overlay
- State Heritage Area Overlay
- State Heritage Place Overlay
- Native Vegetation Overlay
- State Significant Native Vegetation Overlay
- Significant Landscape Protection Overlay
- Ramsar Wetlands Overlay
- River Murray Flood Plain Overlay
- Sloping Land Overlay
- Water Resources Overlay

- 1 The development will not be built, or encroach, on an area that is, or will be, required for a sewerage system or waste control system
- 2 The tank is part of a roof drainage system
- 3 Total floor area - not exceeding 15m²
- 4 The tank is located wholly above ground
- 5 Tank height – does not exceed 4m above natural ground level
- 6 Primary street setback – at least as far back as the building line of the building to which it is ancillary
- 7 In the case of a tank made of metal – the tank is pre-colour treated or painted in a non-reflective colour.

Water tank (underground)

Except where any of the following apply:

- Character Preservation District Overlay

- 1 The development will not be built, or encroach, on an area that is, or will be, required for a sewerage system or waste control system
- 2 The tank (including any associated pump) is located wholly below the level of the ground.

Class of Development The following Classes of Development are classified as Accepted Development subject to meeting the 'Accepted Development Classification Criteria'	Accepted Development Classification Criteria
<ul style="list-style-type: none">• Coastal Areas Overlay• Hazards (Acid Sulfate Soils) Overlay• Native Vegetation Overlay• State Significant Native Vegetation Overlay• Ramsar Wetlands Overlay• Sloping Land Overlay• Water Resources Overlay	

Table 2 – Deemed-to-Satisfy Development Classification

Class of Development The following Classes of Development are classified as Deemed-to-Satisfy Development subject to meeting the 'Deemed-to-Satisfy Development Classification Criteria'	Deemed-to-Satisfy Development Classification Criteria Provisions referred to are Deemed-to-Satisfy Criteria Where a development comprises more than one Class of Development the relevant criteria will be taken to be the sum of the criteria for each Class of Development.			
	Zone	General Development Policies	Subzone (applies only in the area affected by the Subzone)	Overlay (applies only in the area affected by the Overlay)
Advertisement Except where any of the following apply: <ul style="list-style-type: none"> • Advertising Near Signalised Intersections Overlay • Character Area Overlay • Character Preservation Area Overlay • Local Heritage Place Overlay • RAMSAR Wetlands Overlay • River Murray Flood Plain Overlay • Significant Landscape Protection Overlay • State Heritage Place Overlay 	None	Clearance from Overhead Powerlines: DTS 1.1 Advertisements [Appearance]: DTS 1.1, 1.3, 1.4 Advertisements [Proliferation of Advertisements]: DTS 2.1, 2.2 Advertisements [Advertising Content]: DTS 3.1 Advertisements [Amenity Content]: DTS 4.1 Advertising [Safety]: DTS 5.1, 5.2, 5.3, 5.4, 5.5	None	Airport Building Heights (Aircraft Landing Area): DTS 1.1 Airport Building Heights (Regulated): DTS 1.1, 1.2 Building Near Airfields: DTS 1.1 Historic Shipwrecks: DTS 1.1, 1.2 Sloping Land: DTS 3.1, 3.2 Water Resources: DTS 1.5

Class of Development The following Classes of Development are classified as Deemed-to-Satisfy Development subject to meeting the 'Deemed-to-Satisfy Development Classification Criteria'	Deemed-to-Satisfy Development Classification Criteria Provisions referred to are Deemed-to-Satisfy Criteria Where a development comprises more than one Class of Development the relevant criteria will be taken to be the sum of the criteria for each Class of Development.			
	Zone	General Development Policies	Subzone (applies only in the area affected by the Subzone)	Overlay (applies only in the area affected by the Overlay)
<ul style="list-style-type: none"> State Significant Native Vegetation Areas Overlay 				
Agricultural building Except where any of the following apply: <ul style="list-style-type: none"> Advertising Near Signalised Intersections Overlay Building Near Airfields Overlay Character Area Overlay Character Preservation District Area Overlay Coastal Areas Overlay Hazards (Flooding) Overlay Local Heritage Place Overlay RAMSAR Wetlands Overlay 	[Siting and Design] DTS 2.1, 2.2. [Agricultural Buildings] 12.1	Clearance from Overhead Powerlines: DTS 1.1 Infrastructure and Renewable Energy Facilities [Wastewater Services]: DTS 12.2 Interface between Land Uses [Activities Generating Noise or Vibration]: DTS 4.1 Transport, Access and Parking [Movement Systems]: DTS 1.4 Transport, Access and Parking [Vehicle Access]: DTS 3.1	None	Airport Building Heights (Aircraft Landing Area): DTS 1.1 Airport Building Heights (Regulated): DTS 1.1, 1.2 Building Near Airfields Overlay: DTS 1.1, 1.2 Key Outback and Rural Routes: All Key Railway Crossings: DTS 1.1 River Murray Flood Plain: DTS 3.1, 4.3, 5.4, 6.3 Sloping Land: DTS 3.1, 3.2 Water Resources: DTS 1.5

Class of Development The following Classes of Development are classified as Deemed-to-Satisfy Development subject to meeting the 'Deemed-to-Satisfy Development Classification Criteria'	Deemed-to-Satisfy Development Classification Criteria Provisions referred to are Deemed-to-Satisfy Criteria Where a development comprises more than one Class of Development the relevant criteria will be taken to be the sum of the criteria for each Class of Development.			
	Zone	General Development Policies	Subzone (applies only in the area affected by the Subzone)	Overlay (applies only in the area affected by the Overlay)
<ul style="list-style-type: none"> • Significant Landscape Protection Overlay • State Heritage Place Overlay • State Significant Native Vegetation Areas Overlay • Water Protection Area Overlay 				
Carport Except where any of the following apply: <ul style="list-style-type: none"> • Local Heritage Place Overlay • State Heritage Place Overlay 	[Siting and Design] DTS 2.1, 2.2. [Outbuildings, Carports and Verandahs]: DTS 13.2	Infrastructure and Renewable Energy Facilities [Wastewater Services]: DTS 12.2 Transport, Access and Parking [Vehicle Access]: DTS 3.1, 3.5	None	Key Outback and Rural Routes: DTS 1.1, 4.1 Key Railway Crossings: DTS 1.1 Native Vegetation: DTS 1.1, 1.2 Water Resources: DTS 1.5
Dwelling addition Except where any of the following apply: <ul style="list-style-type: none"> • Coastal Areas Overlay 	[Siting and Design] DTS 2.2.	Clearance from Overhead Powerlines: DTS 1.1	None	Airport Building Heights (Aircraft Landing Areas): DTS 1.1

Class of Development The following Classes of Development are classified as Deemed-to-Satisfy Development subject to meeting the 'Deemed-to-Satisfy Development Classification Criteria'	Deemed-to-Satisfy Development Classification Criteria Provisions referred to are Deemed-to-Satisfy Criteria Where a development comprises more than one Class of Development the relevant criteria will be taken to be the sum of the criteria for each Class of Development.			
	Zone	General Development Policies	Subzone (applies only in the area affected by the Subzone)	Overlay (applies only in the area affected by the Overlay)
<ul style="list-style-type: none"> • Hazards (Bushfire – High Risk) Overlay • Hazards (Flooding) Overlay • Local Heritage Place Overlay • RAMSAR Wetlands Overlay • Significant Industry Interface Overlay • Significant Landscape Protection Overlay • State Heritage Place Overlay • State Significant Native Vegetation Areas Overlay • Water Protection Area Overlay 	[Dwellings]: DTS 5.5	Design in Rural Areas [All Development - On-site Waste Treatment Systems]: DTS 6.1 Design in Rural Areas [All Residential Development – External Appearance]: DTS 10.1		Airport Building Heights (Regulated): DTS 1.1, 1.2 Building Near Airfields: DTS 1.1, 1.2 Coastal Areas: DTS 2.1, 2.2, 2.3, 4.5 Hazards (Bushfire – General Risk): DTS 3.2, 5.1, 5.2 Hazards (Bushfire – Medium Risk): DTS 3.2, 5.1, 5.2 Hazards (Acid Sulfate Soils): DTS 1.1 Key Outback and Rural Routes: DTS 1.1, 4.1 Key Railway Crossings: DTS 1.1 River Murray Flood Plain: DTS 3.1, 3.2, 4.2, 4.4, 6.3 Sloping Land: DTS 3.1, 3.2

Class of Development

The following Classes of Development are classified as Deemed-to-Satisfy Development subject to meeting the 'Deemed-to-Satisfy Development Classification Criteria'

Deemed-to-Satisfy Development Classification Criteria

Provisions referred to are Deemed-to-Satisfy Criteria
Where a development comprises more than one Class of Development the relevant criteria will be taken to be the sum of the criteria for each Class of Development.

Zone

General Development Policies

Subzone

(applies only in the area affected by the Subzone)

Overlay

(applies only in the area affected by the Overlay)

Water Resources: DTS 1.5

Excavation and filling

Except where any of the following apply:

- Coastal Areas Overlay
- Hazards (Flooding) Overlay
- Local Heritage Place Overlay
- RAMSAR Wetlands Overlay
- River Murray Flood Plain Overlay
- Significant Landscape Protection Overlay
- State Heritage Area Overlay
- State Heritage Place Overlay

None

Design in Rural Areas [Earthworks]:
DTS 8.1

None

Sloping Land: DTS 3.1, 3.2
Water Resources: DTS 1.5

Class of Development The following Classes of Development are classified as Deemed-to-Satisfy Development subject to meeting the 'Deemed-to-Satisfy Development Classification Criteria'	Deemed-to-Satisfy Development Classification Criteria Provisions referred to are Deemed-to-Satisfy Criteria Where a development comprises more than one Class of Development the relevant criteria will be taken to be the sum of the criteria for each Class of Development.			
	Zone	General Development Policies	Subzone (applies only in the area affected by the Subzone)	Overlay (applies only in the area affected by the Overlay)
<ul style="list-style-type: none"> • State Significant Native Vegetation Areas Overlay • Water Protection Area Overlay 				
Horse keeping Except where any of the following apply: <ul style="list-style-type: none"> • Coastal Areas Overlay • Hazards (Flooding) Overlay • Murray-Darling Basin Overlay • RAMSAR Wetlands Overlay • State Significant Native Vegetation Areas Overlay • Water Protection Area Overlay 	[Siting and Design]: DTS 2.2	Animal Keeping and Horse Keeping [Horse Keeping]: DTS 2.2, 2.3, 2.4, 2.5	None	None

Class of Development

The following Classes of Development are classified as Deemed-to-Satisfy Development subject to meeting the 'Deemed-to-Satisfy Development Classification Criteria'

Deemed-to-Satisfy Development Classification Criteria

Provisions referred to are Deemed-to-Satisfy Criteria
Where a development comprises more than one Class of Development the relevant criteria will be taken to be the sum of the criteria for each Class of Development.

Zone

General Development Policies

Subzone

(applies only in the area affected by the Subzone)

Overlay

(applies only in the area affected by the Overlay)

Horticulture

Except where any of the following apply:

- Coastal Areas Overlay
- Hazards (Flooding) Overlay
- Murray-Darling Basin Overlay
- Prescribed Surface Water Area Overlay
- RAMSAR Wetlands Overlay
- State Heritage Area Overlay
- State Heritage Place Overlay
- State Significant Native Vegetation Areas Overlay
- Water Protection Area Overlay

[Siting and Design]: DTS 2.2
[Horticulture]: DTS 3.1

Interface between Land Uses [Activities Generating Noise or Vibration]: DTS 4.1

None

Building Near Airfields Overlay: DTS 1.1, 1.2
River Murray Flood Plain: DTS 4.4, 6.3, 7.4

Class of Development

The following Classes of Development are classified as Deemed-to-Satisfy Development subject to meeting the 'Deemed-to-Satisfy Development Classification Criteria'

Deemed-to-Satisfy Development Classification Criteria

Provisions referred to are Deemed-to-Satisfy Criteria
Where a development comprises more than one Class of Development the relevant criteria will be taken to be the sum of the criteria for each Class of Development.

	Zone	General Development Policies	Subzone (applies only in the area affected by the Subzone)	Overlay (applies only in the area affected by the Overlay)
<p>Industry Store Transport Distribution Warehouse Except where any of the following apply:</p> <ul style="list-style-type: none"> • Advertising Near Signalised Intersections Overlay • Character Area Overlay • Character Preservation District Area Overlay • Coastal Areas Overlay • Hazards (Flooding) Overlay • Local Heritage Place Overlay • Murray-Darling Basin Overlay • Prescribed Surface Water Area Overlay • RAMSAR Wetlands Overlay 	<p>[Siting and Design]: DTS 2.1, 2.2 [Rural Industry]: DTS 4.1, 4.2</p>	<p>Clearance from Overhead Powerlines: DTS 1.1</p> <p>Design in Rural Areas [On-site Waste Treatment Systems]: DTS 6.1</p> <p>Design in Rural Areas [Car Parking Appearance]: DTS 7.4, 7.5</p> <p>Interface Between Land Uses [Activities Generating Noise or Vibration]: DTS 4.1</p> <p>Infrastructure and Renewable Energy Facilities [Water Supply]: DTS 11.1</p> <p>Infrastructure and Renewable Energy Facilities [Wastewater Services]: DTS 12.1, 12.2</p> <p>Transport, Access and Parking [Movement Systems]: DTS 1.4</p>	<p>None</p>	<p>Airport Building Heights (Aircraft Landing Area): DTS 1.1</p> <p>Airport Building Heights (Regulated): DTS 1.1, 1.2</p> <p>Building Near Airfields Overlay: DTS 1.1, 1.2</p> <p>Key Outback and Rural Routes: All</p> <p>Key Railway Crossings: DTS 1.1</p> <p>Sloping Land: DTS 3.1, 3.2</p> <p>Water Resources: DTS 1.5</p>

Class of Development

The following Classes of Development are classified as Deemed-to-Satisfy Development subject to meeting the 'Deemed-to-Satisfy Development Classification Criteria'

Deemed-to-Satisfy Development Classification Criteria

Provisions referred to are Deemed-to-Satisfy Criteria
Where a development comprises more than one Class of Development the relevant criteria will be taken to be the sum of the criteria for each Class of Development.

	Zone	General Development Policies	Subzone (applies only in the area affected by the Subzone)	Overlay (applies only in the area affected by the Overlay)
<ul style="list-style-type: none"> • River Murray Flood Plain Overlay • Significant Landscape Protection Overlay • State Heritage Area Overlay • State Heritage Place Overlay • State Significant Native Vegetation Areas Overlay • Water Protection Area Overlay 		Transport, Access and Parking [Vehicle Access]: DTS 3.1, 3.5 Transport, Access and Parking [Vehicle Parking Rates]: DTS 5.1 Transport, Access and Parking [Vehicle Parking Areas]: DTS 6.1, 6.6		
<p>Outbuilding (in the form of a garage) Except where any of the following apply:</p> <ul style="list-style-type: none"> • Hazards (Flooding) Overlay • Local Heritage Place Overlay 	[Siting and Design] DTS 2.1, 2.2. [Outbuildings, Carports and Verandahs]: DTS 13.1	Infrastructure and Renewable Energy Facilities [Wastewater Services]: DTS 12.2 Transport, Access and Parking [Vehicle Access]: DTS 3.1, 3.5	None	Airport Building Heights (Aircraft Landing Area): DTS 1.1 Airport Building Heights (Regulated): DTS 1.1, 1.2 Building Near Airfields Overlay: DTS 1.1, 1.2

Class of Development

The following Classes of Development are classified as Deemed-to-Satisfy Development subject to meeting the 'Deemed-to-Satisfy Development Classification Criteria'

Deemed-to-Satisfy Development Classification Criteria

Provisions referred to are Deemed-to-Satisfy Criteria
Where a development comprises more than one Class of Development the relevant criteria will be taken to be the sum of the criteria for each Class of Development.

	Zone	General Development Policies	Subzone (applies only in the area affected by the Subzone)	Overlay (applies only in the area affected by the Overlay)
<ul style="list-style-type: none"> • RAMSAR Wetlands Overlay • Significant Landscape Protection Overlay • State Heritage Place Overlay • State Significant Native Vegetation Areas Overlay • Water Protection Area Overlay 				Key Outback and Rural Routes: All Key Railway Crossings: DTS 1.1 Sloping Land: DTS 3.1, 3.2 Water Resources: DTS 1.5
<p>Outbuilding (not being a garage) Except where any of the following apply:</p> <ul style="list-style-type: none"> • Hazards (Flooding) Overlay • Local Heritage Place Overlay • RAMSAR Wetlands Overlay 	[Siting and Design] DTS 2.2. [Outbuildings, Carports and Verandahs]: DTS 13.1	Infrastructure and Renewable Energy Facilities [Wastewater Services]: DTS 12.2	None	Airport Building Heights (Aircraft Landing Area): DTS 1.1 Airport Building Heights (Regulated): DTS 1.1, 1.2 Building Near Airfields Overlay: DTS 1.1, 1.2 Key Outback and Rural Routes: All

Class of Development The following Classes of Development are classified as Deemed-to-Satisfy Development subject to meeting the 'Deemed-to-Satisfy Development Classification Criteria'	Deemed-to-Satisfy Development Classification Criteria Provisions referred to are Deemed-to-Satisfy Criteria Where a development comprises more than one Class of Development the relevant criteria will be taken to be the sum of the criteria for each Class of Development.			
	Zone	General Development Policies	Subzone (applies only in the area affected by the Subzone)	Overlay (applies only in the area affected by the Overlay)
<ul style="list-style-type: none"> • Significant Landscape Protection Overlay • State Heritage Place Overlay • State Significant Native Vegetation Areas Overlay • Water Protection Area Overlay 				Key Railway Crossings: DTS 1.1 Sloping Land: DTS 3.1, 3.2 Water Resources: DTS 1.5
Shop Except where any of the following apply: <ul style="list-style-type: none"> • Character Area Overlay • Coastal Areas Overlay • Hazards (Flooding) Overlay • Hazards (Bushfire – High Risk) Overlay • Local Heritage Place Overlay • RAMSAR Wetlands Overlay 	[Siting and Design]: DTS 2.1, 2.2 [Shops, Tourism and Function Centres]: DTS 6.1, 6.2 [Adaptive Reuse of Existing Buildings]: DTS 8.1	Clearance from Overhead Powerlines: DTS 1.1 Design in Rural Areas [On-site Waste Treatment Systems]: DTS 6.1 Design in Rural Areas [Car Parking Appearance]: DTS 7.4, 7.5 Interface Between Land Uses [Hours of Operation]: DTS 2.1	None	Airport Building Heights (Aircraft Landing Area): DTS 1.1 Airport Building Heights (Regulated): DTS 1.1, 1.2 Building Near Airfields Overlay: DTS 1.1, 1.2 Hazards (Acid Sulfate Soils): DTS 1.1 Key Outback and Rural Routes: All Key Railway Crossings: DTS 1.1

Class of Development

The following Classes of Development are classified as Deemed-to-Satisfy Development subject to meeting the 'Deemed-to-Satisfy Development Classification Criteria'

Deemed-to-Satisfy Development Classification Criteria

Provisions referred to are Deemed-to-Satisfy Criteria
Where a development comprises more than one Class of Development the relevant criteria will be taken to be the sum of the criteria for each Class of Development.

	Zone	General Development Policies	Subzone (applies only in the area affected by the Subzone)	Overlay (applies only in the area affected by the Overlay)
<ul style="list-style-type: none"> • Significant Landscape Protection Overlay • State Heritage Place Overlay • State Significant Native Vegetation Areas Overlay • Water Protection Area Overlay 		<p>Interface Between Land Uses [Activities Generating Noise or Vibration]: DTS 4.1, 4.6</p> <p>Interface Between Lands Uses [Air Quality]: DTS 5.2</p> <p>Infrastructure and Renewable Energy Facilities [Water Supply]: DTS 11.1</p> <p>Infrastructure and Renewable Energy Facilities [Wastewater Services]: DTS 12.1, 12.2</p> <p>Transport, Access and Parking [Movement Systems]: DTS 1.4</p> <p>Transport, Access and Parking [Vehicle Access]: DTS 3.1, 3.5</p> <p>Transport, Access and Parking [Vehicle Parking Rates]: DTS 5.1</p>		<p>River Murray Flood Plain: DTS 3.1, 4.3, 5.4, 6.3</p> <p>Sloping Land: DTS 3.1, 3.2</p> <p>Water Resources: DTS 1.5</p>

Class of Development

The following Classes of Development are classified as Deemed-to-Satisfy Development subject to meeting the 'Deemed-to-Satisfy Development Classification Criteria'

Deemed-to-Satisfy Development Classification Criteria

Provisions referred to are Deemed-to-Satisfy Criteria
Where a development comprises more than one Class of Development the relevant criteria will be taken to be the sum of the criteria for each Class of Development.

Zone

General Development Policies

Subzone

(applies only in the area affected by the Subzone)

Overlay

(applies only in the area affected by the Overlay)

		Transport, Access and Parking [Vehicle Parking Areas]: DTS 6.1, 6.6		
<p>Tourist accommodation Except where any of the following apply:</p> <ul style="list-style-type: none"> • Character Area Overlay • Coastal Areas Overlay • Hazards (Flooding) Overlay • Hazards (Bushfire – High Risk) Overlay • Local Heritage Place Overlay • RAMSAR Wetlands Overlay • Significant Industry Interface Overlay • Significant Landscape Protection Overlay • State Heritage Area Overlay 	<p>[Siting and Design]: DTS 2.1, 2.2 [Shops, Tourism and Function Centres]: DTS 6.3, 6.4 [Adaptive Reuse of Existing Buildings]: DTS 8.1</p>	<p>Clearance from Overhead Powerlines: DTS 1.1 Infrastructure and Renewable Facilities [Wastewater Services]: DTS 12.1, 12.2 Transport, Access and Parking [Movement Systems]: DTS 1.4 Transport, Access and Parking [Vehicle Access]: DTS 3.1, 3.5 Transport, Access and Parking [Vehicle Parking Rates]: DTS 5.1 Transport, Access and Parking [Vehicle Parking Areas]: DTS 6.1, 6.6</p>	None	<p>Airport Building Heights (Aircraft Landing Area): DTS 1.1 Airport Building Heights (Regulated): DTS 1.1, 1.2 Building Near Airfields Overlay: DTS 1.1, 1.2 Hazards (Acid Sulfate Soils): DTS 1.1 Hazards (Bushfire – General Risk): DTS 3.2, 5.1, 5.2 Hazards (Bushfire – Medium Risk): DTS 3.2, 5.1, 5.2 Key Outback and Rural Routes: All Key Railway Crossings: DTS 1.1 River Murray Flood Plain: DTS 3.1, 4.3, 5.4, 6.3</p>

Class of Development The following Classes of Development are classified as Deemed-to-Satisfy Development subject to meeting the 'Deemed-to-Satisfy Development Classification Criteria'	Deemed-to-Satisfy Development Classification Criteria Provisions referred to are Deemed-to-Satisfy Criteria Where a development comprises more than one Class of Development the relevant criteria will be taken to be the sum of the criteria for each Class of Development.			
	Zone	General Development Policies	Subzone (applies only in the area affected by the Subzone)	Overlay (applies only in the area affected by the Overlay)
<ul style="list-style-type: none"> State Heritage Place Overlay State Significant Native Vegetation Areas Overlay Water Protection Area Overlay 				Sloping Land: DTS 3.1, 3.2 Water Resources: DTS 1.5
Verandah Except where any of the following apply: <ul style="list-style-type: none"> Local Heritage Place Overlay State Heritage Place Overlay 	[Siting and Design] DTS 2.2. [Outbuildings, Carports and Verandahs]: DTS 13.2	Infrastructure and Renewable Energy Facilities [Wastewater Services]: DTS 12.2	None	Airport Building Heights (Aircraft Landing Area): DTS 1.1 Airport Building Heights (Regulated): DTS 1.1, 1.2 Key Outback and Rural Routes: DTS 1.1, 4.1 Key Railway Crossings: DTS 1.1 Water Resources: DTS 1.5

Table 3 – Applicable Policies for Performance Assessed Development

Class of Development	Applicable Policies			
	Zone	General Development Policies	Subzone (applies only in the area affected by the Subzone)	Overlay (applies only in the area affected by the Overlay)
Advertisement	[Land Use and Intensity] PO 1.1 [Built Form and Character]: PO 10.1	Clearance from Overhead Powerlines: PO 1.1 Advertisements [Appearance]: PO 1.1, 1.3, 1.4 Advertisements [Proliferation of Advertisements]: PO 2.1, 2.2 Advertisements [Advertising Content]: PO 3.1 Advertisements [Amenity Content]: PO 4.1 Advertising [Safety]: PO 5.1, 5.2, 5.3, 5.4, 5.5	None	Advertising Near Signalised Intersections: All Airport Building Heights (Aircraft Landing Areas): All Airport Building Heights (Regulated): All Building Near Airfields: All Character Area: All Character Preservation District: All Coastal Areas: All Historic Shipwrecks: All Local Heritage Place: All Native Vegetation: All RAMSAR Wetlands: All Significant Landscape Protection: All

				<p>Sloping Land: All</p> <p>State Heritage place: All</p> <p>State Significant Native Vegetation Areas: All</p> <p>Water Protection Areas: All</p> <p>Water Resources: All</p>
Agricultural building	<p>[Land Use and Intensity] PO 1.1</p> <p>[Siting and Design] PO 2.1, 2.2.</p> <p>[Built Form and Character]: PO 10.1</p> <p>[Agricultural Buildings] PO 12.1</p>	<p>Clearance from Overhead Powerlines: PO 1.1</p> <p>Infrastructure and Renewable Energy Facilities [Wastewater Services]: PO 12.2</p> <p>Interface between Land Uses [Activities Generating Noise or Vibration]: PO 4.1</p> <p>Transport, Access and Parking [Movement Systems]: PO 1.4</p> <p>Transport, Access and Parking [Vehicle Access]: PO 3.1</p>	None	<p>Advertising Near Signalised Intersections: All</p> <p>Airport Building Heights (Aircraft Landing Areas): All</p> <p>Airport Building Heights (Regulated): All</p> <p>Building Near Airfields: All</p> <p>Character Area: All</p> <p>Character Preservation District: All</p> <p>Coastal Areas: All</p> <p>Hazard (Flooding): All</p> <p>Key Outback and Rural Route: All</p> <p>Key Railway Crossings : All</p> <p>Local Heritage Place: All</p> <p>Native Vegetation: All</p> <p>RAMSAR Wetlands: All</p> <p>Significant Landscape Protection: All</p> <p>Sloping Land: All</p> <p>State Heritage Area: All</p> <p>State Heritage Place: All</p> <p>State Significant Native Vegetation Areas: All</p>

				Water Resources: All
Brewery Cidery Distillery Winery	[Land Use and Intensity] PO 1.1 [Siting and Design: PO 2.1, 2.2. [Rural Industry]: PO 4.1, 4.2 [Built Form and Character]: PO 10.1	Beverage Production in Rural Areas: All Clearance from Overhead Powerlines: PO 1.1 Design in Rural Areas [All development – External appearance]: PO 1.5 Design in Rural Areas [On-site Waste Treatment Systems]: PO 6.1 Design in Rural Areas [Car Parking Appearance]: PO 7.2, 7.4, 7.5, 7.6, 7.7 Design in Rural Areas [Earthworks]: PO 8.1 Infrastructure and Renewable Energy Facilities [Water Supply]: PO 11.1 Infrastructure and Renewable Energy Facilities [Wastewater Services]: PO 12.1, 12.2 Interface Between Land Uses [Activities Generating Noise or Vibration]: PO 4.1, 4.2, 4.5, 4.6 Interface Between Land Uses [Air Quality]: PO 5.1, 5.2 Interface Between Land Uses [Light Spill]: PO 6.1	None	Advertising Near Signalised Intersections: All Airport Building Heights (Aircraft Landing Areas): All Airport Building Heights (Regulated): All Building Near Airfields: All Character Area: All Character Preservation District: All Coastal Areas: All Hazard (Flooding): All Hazard (Bushfire – General Risk): All Hazard (Bushfire – High Risk): All Hazard (Bushfire – Medium Risk): All Hazard (Bushfire – Regional): All Hazard (Bushfire – Urban Interface): All Key Outback and Rural Route: All Key Railway Crossings : All Local Heritage Place: All Native Vegetation: All RAMSAR Wetlands: All Significant Landscape Protection: All Sloping Land: All State Heritage Area: All State Heritage Place: All

		<p>Transport, Access and Parking [Movement Systems]: PO 1.4</p> <p>Transport, Access and Parking [Vehicle Access]: PO 3.1, 3.5</p> <p>Transport, Access and Parking [Vehicle Parking Rates]: PO 5.1</p> <p>Transport, Access and Parking [Vehicle Parking Areas]: PO 6.1, 6.6</p>		<p>State Significant Native Vegetation Areas: All</p> <p>Water Resources: All</p>
Carport	<p>[Land Use and Intensity] PO 1.1</p> <p>[Siting and Design: PO 2.1, 2.2.</p> <p>[Built Form and Character]: PO 10.1</p> <p>[Outbuildings, Carports and Verandahs]: PO 13.2</p>	<p>Infrastructure and Renewable Energy Facilities [Wastewater Services]: PO 12.2</p> <p>Transport, Access and Parking [Vehicle Access]: PO 3.1, 3.5</p>	None	<p>Character Preservation District : All</p> <p>Hazards (Flooding) : All</p> <p>Historic Area : All</p> <p>Key Outback and Rural Routes : All</p> <p>Key Railway Crossings : All</p> <p>Local Heritage Place : All</p> <p>Native Vegetation : All</p> <p>Prescribed Watercourses : All</p> <p>Regulated Trees : All</p> <p>Sloping Land : All</p> <p>State Heritage Area : All</p> <p>State Heritage Place: All</p> <p>Significant Landscape Protection : All</p> <p>State Significant Native Vegetation : All</p> <p>Water Protection Area : All</p> <p>Water Resources: All</p>

Demolition	None	None	None	Character Area: All Historic Area: All Local Heritage Place: All State Heritage Area: All State Heritage Place: All
Detached dwelling	[Land Use and Intensity] PO 1.1 [Siting and Design: PO 2.1, 2.2. [Dwellings]: PO 5.1, 5.4 [Built Form and Character]: PO 10.1	Clearance from Overhead Powerlines: PO 1.1 Design in Rural Areas [All Development - On-site Waste Treatment Systems]: PO 6.1 Design in Rural Areas [All Residential Development – External Appearance]: PO 10.1, 10.2 Design in Rural Areas [All Residential Development - Outlook and Amenity] PO 11.1 Design in Rural Areas [All Residential Development - Access and Servicing]: PO 12.1 Design in Rural Areas [Residential Development – 3 Building Levels or Less – External Appearance]: PO 14.1, 14.2, 14.3 Design in Rural Areas [Residential Development – 3 Building Levels or Less – Car Parking, Access and Manoeuvrability]: PO 18.3, 18.4, 18.5 Design in Rural Areas [Design of Transportable Dwellings]: PO 20.1	None	Airport Building Heights (Aircraft Landing Areas): All Airport Building Heights (Regulated): All Building Near Airfields: All Character Area: All Character Preservation District: All Coastal Areas: All Hazards (Acid Sulfate Soils): All Hazards (Flooding): All Hazards (Bushfire – General Risk): All Hazards (Bushfire – High Risk): All Hazards (Bushfire – Medium Risk): All Hazards (Bushfire – Regional): All Hazards (Bushfire – Urban Interface): All Historic Area: All Key Outback and Rural Route: All Key Railway Crossings : All Local Heritage Place: All Native Vegetation: All Noise and Air Emissions: All

		<p>Infrastructure and Renewable Energy Facilities [Water Supply]: PO 11.1</p> <p>Infrastructure and Renewable Energy Facilities [Wastewater Services]: PO 12.1, 12.2</p> <p>Interface Between Land Uses [Interface Between Rural Activities]: PO 9.6, 9.7</p> <p>Interface Between Land Uses [Interface with Mines and Quarries (Rural and Remote Areas): PO 10.1</p> <p>Site Contamination: PO 1.1 Transport, Access and Parking [Vehicle Access]: PO 3.1, 3.5, 3.6</p>		<p>Prescribed Surface Water Area: All</p> <p>RAMSAR Wetlands: All</p> <p>Regulated Tree: All</p> <p>Resource Extraction Protection Area: All</p> <p>Significant Industry Interface: All</p> <p>Significant Landscape Protection: All</p> <p>Sloping Land: All</p> <p>State Heritage Area: All</p> <p>State Heritage Place: All</p> <p>State Significant Native Vegetation Areas: All</p> <p>Strategic Infrastructure (Gas Pipelines) : All</p> <p>Water Protection Area : All</p> <p>Water Resources: All</p>
Dwelling addition	<p>[Land Use and Intensity] PO 1.1</p> <p>[Siting and Design] DTS 2.2.</p> <p>[Dwellings]: PO 5.5</p> <p>[Built Form and Character]: PO 11.1</p>	<p>Clearance from Overhead Powerlines: PO 1.1</p> <p>Design in Rural Areas [All Development - On-site Waste Treatment Systems]: PO 6.1</p> <p>Design in Rural Areas [All Residential Development – External Appearance]: PO 10.1</p>	None	<p>Airport Building Heights (Aircraft Landing Areas): All</p> <p>Airport Building Heights (Regulated): All</p> <p>Building Near Airfields: All</p> <p>Character Area: All</p> <p>Character Preservation District: All</p> <p>Coastal Areas: All</p> <p>Hazards (Acid Sulfate Soils): All</p> <p>Hazards (Flooding): All</p>

				<p>Hazards (Bushfire – General Risk): All</p> <p>Hazards (Bushfire – High Risk): All</p> <p>Hazards (Bushfire – Medium Risk): All</p> <p>Hazards (Bushfire – Regional): All</p> <p>Hazards (Bushfire – Urban Interface): All</p> <p>Historic Area: All</p> <p>Key Outback and Rural Route: All</p> <p>Key Railway Crossings : All</p> <p>Local Heritage Place: All</p> <p>Native Vegetation: All</p> <p>Noise and Air Emissions: All</p> <p>Prescribed Surface Water Area: All</p> <p>RAMSAR Wetlands: All</p> <p>Regulated Tree: All</p> <p>Resource Extraction Protection Area: All</p> <p>Significant Industry Interface: All</p> <p>Significant Landscape Protection: All</p> <p>Sloping Land: All</p> <p>State Heritage Area: All</p> <p>State Heritage Place: All</p> <p>State Significant Native Vegetation Areas: All</p>
--	--	--	--	---

				Strategic Infrastructure (Gas Pipelines) : All Water Protection Area : All Water Resources: All
Excavation and filling	None	Design in Rural Areas [Earthworks]: PO 8.1	None	Character Preservation District: All Local Heritage Place: All Native Vegetation: All State Significant Native Vegetation: All Sloping Land: All State Heritage Place: All State Significant Native Vegetation: All Water Resources: All
Fence	None	Design in Rural Areas [All Development – Fences and Walls]: PO 9.1	None	Local Heritage Place: All State Heritage Area: All State Heritage Place: All Water Resources: All
Function centre	[Land Use and Intensity] PO 1.1 [Siting and Design: PO 2.1, 2.2. [Shops, Tourism and Function	Clearance from Overhead Powerlines: PO 1.1 Design in Rural Areas [All development – External appearance]: PO 1.5 Design in Rural Areas [On-site Waste Treatment Systems]: PO 6.1	None	Advertising Near Signalised Intersections: All Airport Building Heights (Aircraft Landing Areas): All Airport Building Heights (Regulated): All Building Near Airfields: All Character Area: All

	<p>Centres]: PO 6.5, 6.6 [Built Form and Character]: PO 10.1</p>	<p>Design in Rural Areas [Car Parking Appearance]: PO 7.2, 7.4, 7.5, 7.6, 7.7</p> <p>Design in Rural Areas [Earthworks]: PO 8.1</p> <p>Infrastructure and Renewable Energy Facilities [Water Supply]: PO 11.1</p> <p>Infrastructure and Renewable Energy Facilities [Wastewater Services]: PO 12.1, 12.2</p> <p>Interface Between Land Uses [Activities Generating Noise or Vibration]: PO 4.1, 4.2, 4.5, 4.6</p> <p>Interface Between Land Uses [Air Quality]: PO 5.1, 5.2</p> <p>Interface Between Land Uses [Light Spill]: PO 6.1</p> <p>Transport, Access and Parking [Movement Systems]: PO 1.4</p> <p>Transport, Access and Parking [Vehicle Access]: PO 3.1, 3.5</p> <p>Transport, Access and Parking [Vehicle Parking Rates]: PO 5.1</p> <p>Transport, Access and Parking [Vehicle Parking Areas]: PO 6.1, 6.6</p>		<p>Character Preservation District: All</p> <p>Coastal Areas: All</p> <p>Hazard (Bushfire – General Risk): All</p> <p>Hazard (Bushfire – High Risk): All</p> <p>Hazard (Bushfire – Medium Risk): All</p> <p>Hazard (Bushfire – Regional): All</p> <p>Hazard (Bushfire – Urban Interface): All</p> <p>Hazard (Flooding): All</p> <p>Historic Area: All</p> <p>Key Outback and Rural Route: All</p> <p>Key Railway Crossings : All</p> <p>Local Heritage Place: All</p> <p>Native Vegetation: All</p> <p>RAMSAR Wetlands: All</p> <p>Significant Landscape Protection: All</p> <p>Sloping Land: All</p> <p>State Heritage Area: All</p> <p>State Heritage Place: All</p> <p>State Significant Native Vegetation Areas: All</p> <p>Water Resources: All</p>
Horse keeping	<p>[Land Use and Intensity] PO 1.1</p>	<p>Animal Keeping and Horse Keeping [Siting and Design]: PO 1.1, 1.2</p>	<p>None</p>	<p>Murray-Darling Basin: All</p> <p>State Heritage Area : All</p>

	[Siting and Design]: PO 2.2 [Built Form and Character]: PO 10.1	Animal Keeping and Horse Keeping [Horse Keeping]: PO 2.2, 2.3, 2.4, 2.5 Animal Keeping and Horse Keeping [Wastes]: PO 4.1 Interface between Land Use [General Land Use Compatibility] PO 1.2		State Heritage Place: All State Significant Native Vegetation Areas: All Water Resources: All
Horticulture	[Land Use and Intensity] PO 1.1 [Siting and Design]: PO 2.2 [Horticulture]: PO 3.1 [Built Form and Character]: PO 10.1	Interface between Land Uses [General Land Use Compatibility]: PO 1.2 Interface between Land Uses [Activities Generating Noise or Vibration]: PO 4.1, 4.2 Interface between Land Uses [Air Quality]: PO 5.1 Interface between Land Uses [Interface with Rural Activities]: PO 9.1, 9.6	None	Building Near Airfields: All Murray-Darling Basin: All Prescribed Surface Water Area: All Prescribed Water Resources Area : All Prescribed Watercourses: All State Heritage Area: All State Heritage Place: All State Significant Native Vegetation Areas: All Water Protection Area: All Water Resources: All
Industry Store Transport Distribution Warehouse	[Land Use and Intensity] PO 1.1 [Siting and Design]: PO 2.1, 2.2. [Rural Industry]: PO 4.1, 4.2	Clearance from Overhead Powerlines: PO 1.1 Design in Rural Areas [All development – External appearance]: PO 1.5 Design in Rural Areas [On-site Waste Treatment Systems]: PO 6.1	None	Advertising Near Signalised Intersections: All Airport Building Heights (Aircraft Landing Areas): All Airport Building Heights (Regulated): All Building Near Airfields: All Character Area: All

	[Built Form and Character]: PO 10.1	<p>Design in Rural Areas [Car Parking Appearance]: PO 7.2, 7.4, 7.5, 7.6, 7.7</p> <p>Infrastructure and Renewable Energy Facilities [Water Supply]: PO 11.1</p> <p>Infrastructure and Renewable Energy Facilities [Wastewater Services]: PO 12.1, 12.2</p> <p>Interface Between Land Uses [Activities Generating Noise or Vibration]: PO 4.1, 4.2, 4.5</p> <p>Interface Between Land Uses [Air Quality]: PO 5.1, 5.2</p> <p>Interface Between Land Uses [Light Spill]: PO 6.1</p> <p>Transport, Access and Parking [Movement Systems]: PO 1.4</p> <p>Transport, Access and Parking [Vehicle Access]: PO 3.1, 3.5</p> <p>Transport, Access and Parking [Vehicle Parking Rates]: PO 5.1</p> <p>Transport, Access and Parking [Vehicle Parking Areas]: PO 6.1, 6.6</p>		<p>Character Preservation District: All</p> <p>Coastal Areas: All</p> <p>Hazard (Flooding): All</p> <p>Hazard (Bushfire – General Risk): All</p> <p>Hazard (Bushfire – High Risk): All</p> <p>Hazard (Bushfire – Medium Risk): All</p> <p>Hazard (Bushfire – Regional): All</p> <p>Hazard (Bushfire – Urban Interface): All</p> <p>Key Outback and Rural Route: All</p> <p>Key Railway Crossings : All</p> <p>Local Heritage Place: All</p> <p>Murray-Darling Basin: All</p> <p>Native Vegetation: All</p> <p>Prescribed Surface Water Area: All</p> <p>RAMSAR Wetlands: All</p> <p>Significant Landscape Protection: All</p> <p>Sloping Land: All</p> <p>State Heritage Area: All</p> <p>State Heritage Place: All</p> <p>State Significant Native Vegetation Areas: All</p> <p>Water Resources: All</p>
Land division	[Land Division] PO 11.1	Land Division in Rural Areas [Design and Layout]: PO 2.2, 2.4, 2.5, 2.6	None	<p>Character Area: All</p> <p>Character Preservation District: All</p>

		<p>Land Division in Rural Areas [Roads and Access]: 3.1, 3.6, 3.7, 3.8, 3.9</p> <p>Land Division in Rural Areas [Infrastructure]: 4.2, 4.3</p> <p>Land Division in Rural Areas [Minor Land Division (Under 20 Allotments) - Water Sensitive Design]: PO 7.1, 7.2</p>		<p>Dwelling Excision: All</p> <p>Environment and Food Production: All</p> <p>Hazard (Bushfire – General Risk): All</p> <p>Hazard (Bushfire – High Risk): All</p> <p>Hazard (Bushfire – Medium Risk): All</p> <p>Hazard (Bushfire – Regional): All</p> <p>Hazard (Bushfire – Urban Interface): All</p> <p>Historic Area: All</p> <p>Key Outback and Rural Route: All</p> <p>Key Railway Crossings : All</p> <p>Limited Land Division: All</p> <p>Local Heritage Place: All</p> <p>Native Vegetation: All</p> <p>RAMSAR Wetlands: All</p> <p>River Murray Flood Plain: All</p> <p>River Murray Tributaries Area: All</p> <p>Significant Industry Interface: All</p> <p>State Heritage Area: All</p> <p>State Heritage Place: All</p> <p>State Significant Gas Pipelines: All</p> <p>Strategic Infrastructure Gas Pipelines: All</p>
<p>Outbuilding (in the form of a garage)</p>	<p>[Land Use and Intensity] PO 1.1</p> <p>[Siting and Design] PO 2.1, 2.2.</p>	<p>Infrastructure and Renewable Energy Facilities [Wastewater Services]: PO 12.2</p> <p>Transport, Access and Parking [Vehicle Access]: PO 3.1, 3.5</p>	<p>None</p>	<p>Character Area: All</p> <p>Character Preservation District : All</p> <p>Hazards (Flooding) : All</p> <p>Historic Area : All</p>

	<p>[Built Form and Character]: PO 10.1</p> <p>[Outbuildings, Carports and Verandahs]: PO 13.1</p>			<p>Key Outback and Rural Routes : All</p> <p>Key Railway Crossings : All</p> <p>Local Heritage Place : All</p> <p>Native Vegetation : All</p> <p>Regulated Trees : All</p> <p>Sloping Land : All</p> <p>State Heritage Area : All</p> <p>State Heritage Place: All</p> <p>Significant Landscape Protection : All</p> <p>State Significant Native Vegetation : All</p> <p>Water Protection Area : All</p> <p>Water Resources: All</p>
<p>Outbuilding (not being a garage)</p>	<p>[Land Use and Intensity] PO 1.1</p> <p>[Siting and Design] PO 2.2.</p> <p>[Built Form and Character]: PO 10.1</p> <p>[Outbuildings, Carports and Verandahs]: PO 13.1</p>	<p>Infrastructure and Renewable Energy Facilities [Wastewater Services]: PO 12.2</p>	<p>None</p>	<p>Character Area: All</p> <p>Character Preservation District : All</p> <p>Hazards (Flooding) : All</p> <p>Historic Area : All</p> <p>Key Outback and Rural Routes : All</p> <p>Key Railway Crossings : All</p> <p>Local Heritage Place : All</p> <p>Native Vegetation : All</p> <p>Regulated Trees : All</p> <p>Sloping Land : All</p> <p>State Heritage Area : All</p> <p>State Heritage Place: All</p>

				<p>Significant Landscape Protection : All</p> <p>State Significant Native Vegetation : All</p> <p>Water Protection Area : All</p> <p>Water Resources: All</p>
Shop	<p>[Land Use and Intensity] PO 1.1</p> <p>[Siting and Design]: PO 2.1, 2.2</p> <p>[Shops, Tourism and Function Centres]: PO 6.1, 6.2</p> <p>[Adaptive Reuse of Existing Buildings]: PO 8.1</p> <p>[Built Form and Character]: PO 10.1</p>	<p>Clearance from Overhead Powerlines: PO 1.1</p> <p>Design in Rural Areas [All development – External appearance]: PO 1.5</p> <p>Design in Rural Areas [On-site Waste Treatment Systems]: PO 6.1</p> <p>Design in Rural Areas [Car Parking Appearance]: PO 7.2, 7.4, 7.5, 7.6, 7.7</p> <p>Infrastructure and Renewable Energy Facilities [Water Supply]: PO 11.1</p> <p>Infrastructure and Renewable Energy Facilities [Wastewater Services]: PO 12.1, 12.2</p> <p>Interface Between Land Uses [Hours of Operation]: PO 2.1</p> <p>Interface Between Land Uses [Activities Generating Noise or Vibration]: PO 4.1, 4.2, 4.5, 4.6</p> <p>Interface Between Land Uses [Air Quality]: PO 5.2</p>	None	<p>Advertising Near Signalised Intersections: All</p> <p>Airport Building Heights (Aircraft Landing Areas): All</p> <p>Airport Building Heights (Regulated): All</p> <p>Building Near Airfields: All</p> <p>Character Area: All</p> <p>Character Preservation District: All</p> <p>Coastal Areas: All</p> <p>Hazard (Flooding): All</p> <p>Hazard (Bushfire – General Risk): All</p> <p>Hazard (Bushfire – High Risk): All</p> <p>Hazard (Bushfire – Medium Risk): All</p> <p>Hazard (Bushfire – Regional): All</p> <p>Hazard (Bushfire – Urban Interface): All</p> <p>Historic Area: All</p> <p>Key Outback and Rural Route: All</p> <p>Key Railway Crossings : All</p> <p>Local Heritage Place: All</p> <p>Native Vegetation: All</p>

		<p>Interface Between Land Uses [Light Spill]: PO 6.1</p> <p>Transport, Access and Parking [Movement Systems]: PO 1.4</p> <p>Transport, Access and Parking [Vehicle Access]: PO 3.1, 3.5</p> <p>Transport, Access and Parking [Vehicle Parking Rates]: PO 5.1</p> <p>Transport, Access and Parking [Vehicle Parking Areas]: PO 6.1, 6.6</p>		<p>Prescribed Surface Water Area: All</p> <p>RAMSAR Wetlands: All</p> <p>Significant Landscape Protection: All</p> <p>Sloping Land: All</p> <p>State Heritage Area: All</p> <p>State Heritage Place: All</p> <p>State Significant Native Vegetation Areas: All</p> <p>Water Resources: All</p>
<p>Small-scale ground mounted Solar Power facility</p>	<p>[Land Use and Intensity] PO 1.1</p> <p>[Siting and Design]: PO 2.1, 2.2</p> <p>[Renewable Energy Facilities]: PO 9.1, 9.2</p> <p>[Built Form and Character]: PO 10.1</p>	<p>Clearance from Overhead Powerlines: PO 1.1</p> <p>Infrastructure and Renewable Energy Facilities [General]: PO 1.1</p> <p>Infrastructure and Renewable Energy Facilities [Visual Amenity]: PO 2.1</p> <p>Infrastructure and Renewable Energy Facilities [Hazard Management]: PO 4.1, 4.2, 4.3</p> <p>Infrastructure and Renewable Facilities [Wastewater Services]: PO 12.2</p> <p>Infrastructure and Renewable Energy Facilities [Temporary Facilities]: PO 13.1, 13.2</p>	<p>None</p>	<p>Character Area: All</p> <p>Character Preservation District : All</p> <p>Hazards (Flooding) : All</p> <p>Historic Area : All</p> <p>Native Vegetation : All</p> <p>Regulated Trees : All</p> <p>Sloping Land : All</p> <p>State Heritage Area : All</p> <p>State Heritage Place: All</p> <p>Significant Landscape Protection: All</p> <p>State Significant Native Vegetation : All</p> <p>Water Resources: All</p>

		<p>Interface Between Land Uses [General land use compatibility]: PO 1.2</p> <p>Interface Between Land Uses [Solar Reflectivity / Glare]: PO 7.1</p>		
Tourist accommodation	<p>[Land Use and Intensity] PO 1.1 [Siting and Design]: PO 2.1, 2.2 [Shops, Tourism and Function Centres]: PO 6.3, 6.4 [Adaptive Reuse of Existing Buildings]: PO 8.1 [Built Form and Character]: PO 10.1</p>	<p>Clearance from Overhead Powerlines: PO 1.1</p> <p>Infrastructure and Renewable Facilities [Wastewater Services]: PO 12.1, 12.2</p> <p>Tourism Development: All</p> <p>Transport, Access and Parking [Movement Systems]: PO 1.4</p> <p>Transport, Access and Parking [Vehicle Access]: PO 3.1, 3.5</p> <p>Transport, Access and Parking [Vehicle Parking Rates]: PO 5.1</p> <p>Transport, Access and Parking [Vehicle Parking Areas]: PO 6.1, 6.6</p>	None	<p>Airport Building Heights (Aircraft Landing Areas): All</p> <p>Airport Building Heights (Regulated): All</p> <p>Building Near Airfields: All</p> <p>Character Area: All</p> <p>Character Preservation District: All</p> <p>Coastal Areas: All</p> <p>Hazards (Acid Sulfate Soils): All</p> <p>Hazards (Flooding): All</p> <p>Hazards (Bushfire – General Risk): All</p> <p>Hazards (Bushfire – High Risk): All</p> <p>Hazards (Bushfire – Medium Risk): All</p> <p>Hazards (Bushfire – Regional): All</p> <p>Hazards (Bushfire – Urban Interface): All</p> <p>Historic Area: All</p> <p>Key Outback and Rural Route: All</p> <p>Key Railway Crossings : All</p> <p>Local Heritage Place: All</p> <p>Native Vegetation: All</p> <p>Noise and Air Emissions: All</p>

				<p>Prescribed Surface Water Area: All</p> <p>RAMSAR Wetlands: All</p> <p>Regulated Tree: All</p> <p>Resource Extraction Protection Area: All</p> <p>Significant Industry Interface: All</p> <p>Significant Landscape Protection: All</p> <p>Sloping Land: All</p> <p>State Heritage Area: All</p> <p>State Heritage Place: All</p> <p>State Significant Native Vegetation Areas: All</p> <p>Strategic Infrastructure (Gas Pipelines) : All</p> <p>Water Protection Area : All</p> <p>Water Resources: All</p>
Verandah	<p>[Land Use and Intensity] PO 1.1</p> <p>[Siting and Design] PO 2.2.</p> <p>[Built Form and Character]: PO 10.1</p> <p>[Outbuildings, Carports and</p>	<p>Infrastructure and Renewable Energy Facilities [Wastewater Services]: PO 12.2</p>	None	<p>Character Area: All</p> <p>Character Preservation District : All</p> <p>Historic Area : All</p> <p>Local Heritage Place : All</p> <p>Native Vegetation : All</p> <p>Regulated Trees : All</p> <p>Sloping Land : All</p> <p>State Heritage Area : All</p>

	Verandahs]: PO 13.2			State Heritage Place: All Significant Landscape Protection : All State Significant Native Vegetation : All Water Resources: All
Workers' accommodation	[Land Use and Intensity] PO 1.1 [Siting and Design]: PO 2.1, 2.2 [Dwellings] PO 5.2, 5.3, 5.4 [Adaptive Reuse of Existing Buildings]: PO 8.1 [Built Form and Character]: PO 11.1	Clearance from Overhead Powerlines: PO 1.1 Infrastructure and Renewable Facilities [Wastewater Services]: PO 12.1, 12.2 Transport, Access and Parking [Movement Systems]: PO 1.4 Transport, Access and Parking [Vehicle Access]: PO 3.1, 3.5 Transport, Access and Parking [Vehicle Parking Rates]: PO 5.1 Transport, Access and Parking [Vehicle Parking Areas]: PO 6.1, 6.6 Workers Accommodation and Settlements: All	None	Airport Building Heights (Aircraft Landing Areas): All Airport Building Heights (Regulated): All Building Near Airfields: All Character Area: All Character Preservation District: All Coastal Areas: All Hazards (Acid Sulfate Soils): All Hazards (Flooding): All Hazards (Bushfire – General Risk): All Hazards (Bushfire – High Risk): All Hazards (Bushfire – Medium Risk): All Hazards (Bushfire – Regional): All Hazards (Bushfire – Urban Interface): All Historic Area: All Key Outback and Rural Route: All Key Railway Crossings : All Local Heritage Place: All Native Vegetation: All

				<p>Noise and Air Emissions: All</p> <p>Prescribed Surface Water Area: All</p> <p>RAMSAR Wetlands: All</p> <p>Regulated Tree: All</p> <p>Resource Extraction Protection Area: All</p> <p>Significant Industry Interface: All</p> <p>Significant Landscape Protection: All</p> <p>Sloping Land: All</p> <p>State Heritage Area: All</p> <p>State Heritage Place: All</p> <p>State Significant Native Vegetation Areas: All</p> <p>Strategic Infrastructure (Gas Pipelines) : All</p> <p>Water Protection Area : All</p> <p>Water Resources: All</p>
All other Code Assessed Development	All	All	None	All

Table 4 –Restricted Development Classification

Class of Development The following Classes of Development are classified as Restricted subject to any 'Exclusions'	Exclusions
Dwelling within the Limited Dwelling Overlay	Except where it is a replacement dwelling.
Land Division within the Limited Land Division Overlay	Except where it involves a boundary realignment.
Land Division creating additional allotments for residential purposes within the Significant Industry Interface Overlay	
Renewable energy facility within either the: (a) Significant Landscape Protection Overlay (b) Character Preservation Area Overlay	
Shop	Except where: (a) it is ancillary to and located on the same allotment or adjoining allotment used for primary production or value adding and offers for sale or consumption produce or goods that are primarily sourced, produced or manufactured on the same allotment or from the region; or (b) it has a gross leasable floor area less than 250m ² ; or (c) it is a restaurant.

Assessment Provisions

Desired Outcomes (DO)

DO 1

A zone supporting the economic prosperity of South Australia primarily through the production, processing, storage and distribution of primary produce, forestry and the generation of energy from renewable sources.

DO 2

A zone supporting diversification of existing businesses that promote value adding, such as industry, storage and warehousing activities, the sale and consumption of primary produce, tourist development and accommodation.

Performance Outcomes and Deemed to Satisfy / Designated Performance Outcome Criteria

Land Use and Intensity

PO 1.1

The productive value of rural land for a range of primary production activities and associated value adding, processing, warehousing and distribution is supported, protected and maintained.

DTS/DPF 1.1

Development comprises one or more of the following land uses:

- (a) Advertisement
- (b) Agricultural building
- (c) Brewery
- (d) Carport
- (e) Cidery
- (f) Distillery
- (g) Demolition
- (h) Detached dwelling
- (i) Dwelling addition
- (j) Excavation and filling
- (k) Farming
- (l) Fence
- (m) Horse keeping
- (n) Horticulture

- (o) Industry
- (p) Intensive animal husbandry
- (q) Low intensity animal husbandry
- (r) Outbuilding
- (s) Shop
- (t) Small-scale ground mounted solar power facility
- (u) Tourist accommodation
- (v) Transport distribution
- (w) Verandah
- (x) Warehouse
- (y) Winery

Siting and Design

PO 2.1

Development is provided with suitable vehicle access.

DTS/DPF 2.1

Development is serviced by an all-weather trafficable public road.

PO 2.2

Buildings are generally located on flat land to avoid cut and fill and the associated visual impacts.

DTS/DPF 2.2

Buildings:

- (a) are sited on land with a slope not greater than 10% (1-in-10); and
- (b) do not result excavation and filling of land that is greater than 1.5 metres from natural ground level.

Horticulture

PO 3.1

Horticulture is located and conducted on land that has the physical capability of supporting the activity and in a manner that:

- (a) enhances the productivity of the land for the growing of food and produce in a sustainable manner;
- (b) avoids adverse interface conflicts with other land uses;
- (c) utilises sound environmental practices to mitigate negative impacts on natural resources and water quality;

- (d) is sympathetic to surrounding rural landscape character and amenity, where horticulture is proposed to be carried out in an enclosed building such as such as greenhouses.

DTS/DPF 3.1

Horticultural activities:

- (a) are conducted on an allotment with an area of at least 1ha;
- (b) are sited on land with a slope not greater than 10% (1-in10);
- (c) are not conducted within 50m of a watercourse or native vegetation;
- (d) do not involve the clearance of native vegetation;
- (e) abut an existing horticulture activity;
- (f) are not conducted within 100m of a sensitive receiver in other ownership;
- (g) provide for a headland area between plantings and property boundaries of at least 10m in width; and
- (h) where carried out in an enclosed building such as a greenhouse, the building has a total floor area not greater than 250m²;
- (i) in the form of olive growing, is not located within 500 metres of a conservation or national park.

Rural Industry

PO 4.1

Industry (including beverage production and washing, processing, bottling and packaging activities), storage, warehousing, transport distribution or similar activities:

- (a) are directly related to and add value to primary production and/or commodities and materials sourced from rural areas; and
- (b) realise efficiencies in primary production.

DTS/DPF 4.1

Industries, storage, warehousing and transport distribution activities:

- (a) are directly related to and ancillary to a primary production use on the same or adjoining allotment;
- (b) are located on an allotment not less than 20ha in area;
- (c) have a total floor area not exceeding 250m².

PO 4.2

Industry, storage, warehousing, transport distribution or similar activities are sited, designed and of a scale that maintains rural character and function and respects landscape amenity.

DTS/DPF 4.2

Buildings and associated activities:

- (a) are setback at least 100m from all road and allotment boundaries;
- (b) are not sited within 200m of a sensitive receiver in other ownership;
- (c) have building height not greater than 10m above natural ground level; and
- (d) incorporate the loading and unloading of vehicles within the confines of the allotment.

Dwellings

PO 5.1

Residential development is ancillary to, and does not compromise, primary production.

DTS/DPF 5.1

Dwellings:

- (a) are located on an allotment with an area not less than that specified in the *Minimum Allotment Size Technical and Numeric Variation Overlay*;
- (b) are located on and have a demonstrated connection with an allotment used for primary production or value adding; will not result in more than one dwelling on an allotment.

PO 5.2

Development creating a second dwelling on an allotment should not compromise primary production and value adding industries, or result in the fragmentation of land.

DTS/DPF 5.2

A secondary dwelling on an allotment is:

- (a) located within 20 metres of an existing dwelling on the same allotment;
- (b) utilises existing infrastructure and vehicle access used by an existing dwelling; and
- (c) located on an allotment not less than 40ha in area.

PO 5.3

Residential development resulting in more than one dwelling on an allotment:

- (a) supports aging in place for the owner of the allotment;
- (b) is in the form of a manager's residence or workers' accommodation;

- (c) is located within 20 metres of an existing dwelling on the same allotment;
- (d) does not compromise primary production or value adding industries;
- (e) utilises existing infrastructure and vehicle access used by an existing dwelling

DTS/DPF 5.3

None are applicable.

PO 5.4

Dwellings are sited, designed and of a scale that maintains a pleasant rural character and amenity.

DTS/DPF 5.4

Dwellings:

- (a) are setback from all allotment boundaries by at least 40m;
- (b) do not exceed 2 building levels and 9 metres measured from the top of the footings; and
- (c) have a wall height that is no greater than 6 metres.

PO 5.5

Dwelling additions are sited, designed and of a scale that maintains a pleasant rural character and amenity.

DTS/DPF 5.5

Additions or alterations to an existing dwelling:

- (a) are setback behind the main façade of the existing dwelling;
- (b) do not exceed 2 building levels and 9 metres measured from the top of the footings; and
- (c) have a wall height that is no greater than 6 metres.

Shops, Tourism and Function Centres

PO 6.1

Shops are associated with an existing primary production use or value adding industry within the region.

DTS/DPF 6.1

Shops:

- (a) are ancillary to and located on the same allotment or an adjoining allotment used for primary production or value adding;
- (b) offer for sale or consumption produce or goods that are primarily sourced, produced or manufactured on the same allotment or from the region;
- (c) have a gross leasable floor area not exceeding 100m²;

(d) have an area for the display of produce or goods external to a building not exceeding 25m².

PO 6.2

Shops that are proposed in new buildings are sited, designed and of a scale that maintains a pleasant rural character and amenity.

DTS/DPF 6.2

Shops in new buildings:

- (a) are setback from all allotment boundaries by at least 40m;
- (b) are not sited within 100m of a sensitive receiver in other ownership; and
- (c) have a building height that does not exceed 7m above natural ground level.

PO 6.3

Tourist accommodation is associated with the primary use of the land for primary production or value adding industry.

DTS/DPF 6.3

Tourist accommodation:

- (a) is ancillary to and located on the same allotment or an adjoining allotment used for primary production or value adding;
- (b) in relation to the area used for accommodation, does not exceed 100m².

PO 6.4

Tourist accommodation proposed in a new building or buildings are sited, designed and of a scale that maintains a pleasant rural character and amenity.

DTS/DPF 6.4

Tourist accommodation in new buildings:

- (a) is setback from all allotment boundaries by at least 40m; and
- (b) have a building height that does not exceed 7m above natural ground level.

PO 6.5

Function centres are associated with the primary use of the land for primary production or value adding industry.

DTS/DPF 6.5

Function centres:

- (a) are ancillary to and located on the same allotment or an adjoining allotment used for primary production or value adding;
- (b) do not result in more than 75 seats for customer dining purposes.

PO 6.6

Function centres are sited, designed and of a scale that maintains a pleasant natural and rural character and amenity.

DTS/DPF 6.6

Function centres:

- (a) are located on an allotment having an area of at least 5ha;
- (b) are setback from all property boundaries by at least 40m;
- (c) are not sited within 100m of a sensitive receiver in other ownership; and
- (d) have a building height that does not exceed 9m above natural ground level.

Offices

PO 7.1

Offices are directly related to and associated with the primary use of the land for primary production or value adding industry

DTS/DPF 7.1

Offices:

- (a) are ancillary to and located on the same allotment or an adjoining allotment used for primary production or value adding;
- (b) have a gross leasable floor area not exceeding 100m².

Adaptive Reuse of Existing Buildings

PO 8.1

Adaptive reuse of existing buildings for small-scale shops, offices, tourist accommodation or ancillary rural activities.

DTS/DPF 8.1

Development within an existing building is for:

- (a) a shop;
- (b) office; or
- (c) tourist accommodation.

Renewable Energy Facilities

PO 9.1

Renewable energy facilities and ancillary development minimises significant fragmentation or displacement of existing primary production.

DTS/DPF 9.1

None are applicable.

PO 9.2

Small-scale ground mounted solar power facilities support rural production or value adding industries.

DTS/DPF 9.2

Solar power facilities:

- (a) do not generate more than 30KW;
- (b) generate power which is to be used wholly in association with a primary production industry, a value adding industry or local infrastructure facility on the same allotment;
- (c) do not have a panel size exceeding 80m² or 4m in height per structure;
- (d) do not involve more than 2 panel structures per allotment;
- (e) are setback at least 10m from adjoining allotments in other ownership; and
- (f) are not located within 100m of a dwelling in other ownership.

Built Form and Character

PO 10.1

Large buildings designed and sited to reduce impacts on scenic and rural vistas by:

- (a) having substantial setbacks from boundaries and adjacent public roads;
- (b) using low reflective materials and finishes that blend with the surrounding landscape; and
- (c) being located below ridgelines

DTS/DPF 10.1

None are applicable.

Land Division

PO 11.1

Land division, including boundary realignments promotes productive, efficient and sustainable primary production.

DTS/DPF 11.1

Allotments have an area not less than that specified in the *Minimum Allotment Size Technical and Numeric Variation Overlay*.

Agricultural Buildings

PO 12.1

Agricultural buildings and associated activities are sited, designed and of a scale that maintains rural character and function and respects landscape amenity.

DTS/DPF 12.1

- (a) Agricultural buildings:
- (b) are located on an allotment having an area of at least 10ha;
- (c) are setback at least 50m from an allotment boundary;
- (d) have a building height not exceeding 10m above natural ground level;
- (e) do not exceed 250m² in total floor area; and
- (f) incorporate the loading and unloading of vehicles within the confines of the allotment.

Outbuildings, Carports and Verandahs

PO 13.1

Outbuildings are sited, designed and of a scale that maintain a pleasant rural character and amenity.

DTS/DPF 13.1

Outbuildings:

- (a) have a primary street setback that is at least as far back as the building to which it is ancillary;
- (b) have a total floor area that does not exceed 150m²;
- (c) have walls that do not exceed 5m in height measured from natural ground level and not including a gable end;
- (d) have a total roof height that does not exceed 6m measured from natural ground level; and
- (e) are limited to no more than 2 outbuildings on the same allotment.

PO 13.2

Carports and verandahs are sited, designed and of a scale that maintain a pleasant rural character and amenity.

DTS/DPF 13.2

Carports and verandahs have a:

- (a) primary street setback that is at least as far back as the building to which it is ancillary;
- (b) total floor area that does not exceed 80m²;
- (c) post height that does not exceed 3m measured from natural ground level and not including a gable end; and
- (d) total roof height that does not exceed 5m measured from natural ground level.

Concept Plans

PO 14.1

Development is compatible with the outcomes sought by any relevant Concept Plan contained within the *Concept Plans Technical and Numeric Variation Overlay*.

DTS 14.1

None are applicable

Procedural Matters (PM)

Notification

All classes of performance assessed development are excluded from notification except where they involve any of the following:

- (a) the site of the development is adjacent to land in a different zone
- (b) development identified as “all other code assessed development” in Rural Zone Table 3
- (c) detached dwelling
- (d) industry, storage, transport distribution and/or warehousing with a total floor area greater than 250m²
- (e) renewable energy facilities other than a solar power facility that does not generate more than 30KW
- (f) shop with a gross leasable area greater than 200m²
- (g) tourist accommodation with a total floor area greater than 200m²
- (h) wind farm
- (i) wind monitoring mast
- (j) workers' accommodation

Rural Shack Settlement Zone

Table 1 – Accepted Development Classification

Class of Development The following Classes of Development are classified as Accepted Development subject to meeting the 'Accepted Development Classification Criteria'	Accepted Development Classification Criteria
Building work on railway land	4 Building work is associated with a railway 5 It is situated (or to be situated) on railway land 6 It is required for the conduct or maintenance of railway activities.
Carport Except where any of the following apply: <ul style="list-style-type: none"> • Coastal Areas Overlay • Hazards (Acid Sulfate Soils) Overlay • Local Heritage Place Overlay • State Heritage Place Overlay • Native Vegetation Overlay • State Significant Native Vegetation Overlay • Ramsar Wetlands Overlay • River Murray Flood Plain Overlay • Sloping Land Overlay • Key Outback and Rural Routes Overlay where an existing access is altered or a new access is created • Urban Transport Routes Overlay where an existing access is altered or a new access is created • Water Resources Overlay 	13 The development will not be built, or encroach, on an area that is, or will be, required for a sewerage system or waste control system 14 It is ancillary to a dwelling erected on the site 15 Primary street setback – at least 5.5m from the primary street boundary and as far back as the building line of the building to which it is ancillary 16 Secondary street setback – at least 900mm from the boundary of the allotment (if the land has boundaries on two or more roads) 17 Total floor area - does not exceed 40m ² 18 Post height - does not exceed 3m measured from natural ground level (and not including a gable end) 19 Building height - does not exceed 5m 20 If situated on or abutting a boundary (not being a boundary with a primary street or secondary street) – a length not exceeding 10m unless: <ul style="list-style-type: none"> (a) a longer wall or structure exists on the adjacent site and is situated on the same allotment boundary; and (b) the proposed wall or structure will be built along the same length of boundary as the existing adjacent wall or structure to the same or lesser extent 21 If the carport abuts or is situated on the boundary of the allotment (not being a boundary with a primary street or secondary street): <ul style="list-style-type: none"> (a) it will not result in all relevant walls or structures located along the boundary exceeding 45% of the length of the boundary; and (b) it will not be located within 3m of any other wall along the same boundary unless on an adjacent site on that boundary there is an existing wall of a building that would be adjacent to or abut the proposed wall or structure 22 The total roofed area of all existing or proposed buildings on the allotment does not exceed 60% of the area of the allotment 23 Door opening for vehicle access – does not exceed, in total, 7m in width or 50% of the width of the allotment frontage (whichever lesser) 24 Internal dimensions – does not exceed 3.2m in width and 6m in length between all fences, walls and doors 25 The carport: <ul style="list-style-type: none"> (a) is located so that vehicle access: <ul style="list-style-type: none"> i. is provided via a lawfully existing or authorised driveway or access point or an access point for which consent has been granted as part of an application for the division of land; or ii. will use a driveway that: <ul style="list-style-type: none"> A. is not located within 6 metres of an intersection of 2 or more roads or a pedestrian actuated crossing; and B. will not interfere with an item of street furniture (including directional signs, lighting, seating and weather shelters), other infrastructure, or a tree; or iii. if adjacent a kerbed road, will be via a kerb that is designed to allow a vehicle to roll over it; and (b) is located so that the gradient from the place of access on the boundary of the allotment to the finished floor level at the front of the carport when the work is completed is not steeper than 1:4 on average; and (c) The centre of the driveway at the public road boundary is no more than 25 degree deviation from the centre of the front of the covered car parking space for which it provides vehicle access
Internal building work Except where any of the following apply: <ul style="list-style-type: none"> • A Local Heritage Place identified in the Local Heritage Place Overlay • A State Heritage Place identified in the State Heritage Place Overlay 	5 There will be no increase in the total floor area of the building 6 There will be no alteration to the external appearance of the building.
Outbuilding (in the form of a garage) Except where any of the following apply: <ul style="list-style-type: none"> • Coastal Areas Overlay • Hazards (Acid Sulfate Soils) Overlay 	15 The development will not be built, or encroach, on an area that is, or will be, required for a sewerage system or waste control system 16 It is detached from and ancillary to a dwelling erected on the site. 17 Primary street setback – at least 5.5m from the primary street boundary and as far back as the building line of the building to which it is ancillary

Class of Development The following Classes of Development are classified as Accepted Development subject to meeting the 'Accepted Development Classification Criteria'	Accepted Development Classification Criteria
<ul style="list-style-type: none"> • Local Heritage Place Overlay • State Heritage Place Overlay • Native Vegetation Overlay • State Significant Native Vegetation Overlay • Ramsar Wetlands Overlay • River Murray Flood Plain Overlay • Sloping Land Overlay • Key Outback and Rural Routes Overlay where an existing access is altered or a new access is created • Urban Transport Routes Overlay where an existing access is altered or a new access is created • Water Resources Overlay 	<p>18 Secondary street setback – at least 900mm from the boundary of the allotment (if the land has boundaries on two or more roads)</p> <p>19 Total floor area - does not exceed 40m²</p> <p>20 Wall height - does not exceed 3m measured from natural ground level (and not including a gable end)</p> <p>21 Building height - does not exceed 5m</p> <p>22 If situated on or abutting a boundary (not being a boundary with a primary street or secondary street) – a length not exceeding 10m unless:</p> <p>(a) a longer wall or structure exists on the adjacent site and is situated on the same allotment boundary; and</p> <p>(b) the proposed wall or structure will be built along the same length of boundary as the existing adjacent wall or structure to the same or lesser extent</p> <p>23 If the outbuilding abuts or is situated on the boundary of the allotment (not being a boundary with a primary street or secondary street):</p> <p>(a) it will not result in all relevant walls or structures located along the boundary exceeding 45% of the length of the boundary; and</p> <p>(b) it will not be located within 3m of any other wall along the same boundary unless on an adjacent site on that boundary there is an existing wall of a building that would be adjacent to or abut the proposed wall or structure</p> <p>24 Total roofed area of all existing and proposed buildings on the allotment - does not exceed 60%</p> <p>25 Internal dimensions – exceed 3.2m in width and 6m in length between all walls and doors</p> <p>26 Door opening for vehicle access – does not exceed, in total, 7m in width or 50% of the width of the allotment frontage (whichever lesser)</p> <p>27 The garage:</p> <p>(a) is located so that vehicle access:</p> <p>i. is provided via a lawfully existing or authorised driveway or access point or an access point for which consent has been granted as part of an application for the division of land; or</p> <p>ii. will use a driveway that:</p> <p>A. is not located within 6 metres of an intersection of 2 or more roads or a pedestrian actuated crossing; and</p> <p>B. will not interfere with an item of street furniture (including directional signs, lighting, seating and weather shelters), other infrastructure, or a tree; or</p> <p>iii. if adjacent a kerbed road, will be via a kerb that is designed to allow a vehicle to roll over it; and</p> <p>(b) is located so that the gradient from the place of access on the boundary of the allotment to the finished floor level at the front of the carport when the work is completed is not steeper than 1:4 on average; and</p> <p>(c) The centre of the driveway at the public road boundary is no more than 25 degree deviation from the centre of the front of the covered car parking space for which it provides vehicle access</p> <p>28 If clad in sheet metal—is pre-colour treated or painted in a non-reflective colour.</p>
<p>Outbuilding (not being a garage) Except where any of the following apply:</p> <ul style="list-style-type: none"> • Coastal Areas Overlay • Hazards (Acid Sulfate Soils) Overlay • Local Heritage Place Overlay • State Heritage Place Overlay • Native Vegetation Overlay • State Significant Native Vegetation Overlay • Ramsar Wetlands Overlay • River Murray Flood Plain Overlay • Sloping Land Overlay • Water Resources Overlay 	<p>12 The development will not be built, or encroach, on an area that is, or will be, required for a sewerage system or waste control system</p> <p>13 It is detached from and ancillary to a dwelling erected on the site</p> <p>14 Primary street setback – at least as far back as the building line of the building to which it is ancillary</p> <p>15 Secondary street setback – at least 900mm from the boundary of the allotment (if the land has boundaries on two or more roads)</p> <p>16 Side boundary setbacks – at least 900mm from the boundary of the allotment</p> <p>17 Total floor area does not exceed 40m²</p> <p>18 Wall height - does not exceed 3m measured from natural ground level (and not including a gable end)</p> <p>19 Building height - does not exceed 5m</p> <p>20 If situated on or abutting a boundary (not being a boundary with a primary street or secondary street) – a length not exceeding 10m unless:</p> <p>(a) a longer wall or structure exists on the adjacent site and is situated on the same allotment boundary; and</p> <p>(b) the proposed wall or structure will be built along the same length of boundary as the existing adjacent wall or structure to the same or lesser extent</p> <p>21 If the outbuilding abuts or is situated on the boundary of the allotment (not being a boundary with a primary street or secondary street):</p> <p>(a) it will not result in all relevant walls or structures located along the boundary exceeding 45% of the length of the boundary; and</p>

Class of Development The following Classes of Development are classified as Accepted Development subject to meeting the 'Accepted Development Classification Criteria'	Accepted Development Classification Criteria
	(b) will not be located within 3m of any other wall along the same boundary unless on an adjacent site on that boundary there is an existing wall of a building that would be adjacent to or abut the proposed wall or structure 22 Total roofed area of all existing and proposed buildings on the allotment - does not exceed 60% 23 If clad in sheet metal—is pre-colour treated or painted in a non-reflective colour.
Private bushfire shelters Except where any of the following apply: <ul style="list-style-type: none"> • Coastal Areas Overlay • Hazards (Acid Sulfate Soils) Overlay • Local Heritage Place Overlay • State Heritage Place Overlay • Native Vegetation Overlay • State Significant Native Vegetation Overlay • Ramsar Wetlands Overlay • River Murray Flood Plain Overlay • Sloping Land Overlay • Water Resources Overlay 	5 The development will not be built, or encroach, on an area that is, or will be, required for a sewerage system or waste control system 6 Primary street setback – at least as far back as the building to which it is ancillary 7 Secondary street setback – at least 900mm from the boundary of the allotment 8 At least 6m from the corner of an allotment which abuts the intersection of two or more roads (other than where a 4m x 4m allotment cut-off is already in place).
Shade sail Except where any of the following apply: <ul style="list-style-type: none"> • Coastal Areas Overlay • Hazards (Acid Sulfate Soils) Overlay • Local Heritage Place Overlay • State Heritage Place Overlay • Native Vegetation Overlay • State Significant Native Vegetation Overlay • Ramsar Wetlands Overlay • River Murray Flood Plain Overlay • Sloping Land Overlay • Water Resources Overlay 	8 The development will not be built, or encroach, on an area that is, or will be, required for a sewerage system or waste control system 9 Shade sail consists of permeable material 10 The total area of the sail - does not exceed 40m ² 11 No part of the shade sail will be: <ul style="list-style-type: none"> (a) 3m above ground or floor level (depending on where it is situated) at any place within 900mm of a boundary of the allotment (b) 5m above ground or floor level (depending on where it is situated) within any other part of the allotment 12 Primary street setback – at least as far back as the building line of the building to which it is ancillary 13 If any part of the sail will be situated on a boundary of the allotment, the length of sail along a boundary does not exceed 8m 14 In a case where any part of the sail or a supporting structure will be situated on a side boundary of the allotment — the length of the sail and any such supporting structure together with all relevant walls or structures located along the boundary will not exceed 45% of the length of the boundary.
Solar photovoltaic panels (roof mounted) Except where any of the following apply: <ul style="list-style-type: none"> • Local Heritage Place identified in the Local Heritage Place Overlay • State Heritage Place identified in the State Heritage Place Overlay 	4 Panels are installed parallel to the roof of a building and with the underside surface of the panel not being more than 100mm above the surface of the roof 5 Panels and associated components do not overhang any part of the roof 6 Does not apply to system with a generating capacity of more than 5MW that is to be connected to the State's power system.
Spa pool Swimming pool Except where any of the following apply: <ul style="list-style-type: none"> • Coastal Areas Overlay • Hazards (Acid Sulfate Soils) Overlay • Local Heritage Place Overlay • State Heritage Place Overlay • Native Vegetation Overlay • State Significant Native Vegetation Overlay • Ramsar Wetlands Overlay • River Murray Flood Plain Overlay • Sloping Land Overlay • Water Resources Overlay 	31 The development will not be built, or encroach, on an area that is, or will be, required for a sewerage system or waste control system 32 It is ancillary to a dwelling erected on the site 33 Allotment boundary setback – not less than 1m 34 Primary street setback – at least as far back as the building line of the building to which it is ancillary 35 Location of filtration system from a dwelling on an adjoining allotment: <ul style="list-style-type: none"> (a) not less than 5m where the filtration system is located inside a solid structure that will have material impact on the transmission of noise (b) not less than 12m in any other case.
Verandah Except where any of the following apply: <ul style="list-style-type: none"> • Coastal Areas Overlay • Hazards (Acid Sulfate Soils) Overlay • Local Heritage Place Overlay • State Heritage Place Overlay • Native Vegetation Overlay • State Significant Native Vegetation Overlay • Ramsar Wetlands Overlay 	8 The development will not be built, or encroach, on an area that is, or will be, required for a sewerage system or waste control system 9 It is ancillary to a dwelling erected on the site 10 Primary street setback – as far back as the building line of the building to which it is ancillary 11 Total floor area - does not exceed 40m ² 12 Post height - does not exceed 3m measured from natural ground level 13 Building height - does not exceed 5m 14 Length - does not exceed 10m if any part of the structure abuts or is situated on a boundary of the allotment

Class of Development	Accepted Development Classification Criteria
The following Classes of Development are classified as Accepted Development subject to meeting the 'Accepted Development Classification Criteria'	
<ul style="list-style-type: none"> River Murray Flood Plain Overlay Water Resources Overlay 	15 Total roofed area of all existing and proposed buildings on the allotment - does not exceed 60%.
Water tank (above ground) Except where any of the following apply: <ul style="list-style-type: none"> Coastal Areas Overlay Local Heritage Place Overlay State Heritage Place Overlay Native Vegetation Overlay State Significant Native Vegetation Overlay Ramsar Wetlands Overlay River Murray Flood Plain Overlay Sloping Land Overlay Water Resources Overlay 	8 The development will not be built, or encroach, on an area that is, or will be, required for a sewerage system or waste control system 9 The tank is part of a roof drainage system 10 Total floor area - not exceeding 15m ² 11 The tank is located wholly above ground 12 Tank height – does not exceed 4m above natural ground level 13 Primary street setback – at least as far back as the building line of the building to which it is ancillary 14 In the case of a tank made of metal – the tank is pre-colour treated or painted in a non-reflective colour.
Water tank (underground) Except where any of the following apply: <ul style="list-style-type: none"> Coastal Areas Overlay Hazards (Acid Sulfate Soils) Overlay Native Vegetation Overlay State Significant Native Vegetation Overlay Ramsar Wetlands Overlay Sloping Land Overlay Water Resources Overlay 	3 The development will not be built, or encroach, on an area that is, or will be, required for a sewerage system or waste control system 4 The tank (including any associated pump) is located wholly below the level of the ground.

Table 2 – Deemed-to-Satisfy Development Classification

Class of Development	Deemed-to-Satisfy Development Classification Criteria			
The following Classes of Development are classified as Deemed-to-Satisfy Development subject to meeting the 'Deemed-to-Satisfy Development Classification Criteria'	Provisions referred to are Deemed-to-Satisfy Criteria Where a development comprises more than one Class of Development the relevant criteria will be taken to be the sum of the criteria for each Class of Development.			
	Zone	General Development Policies	Subzone (applies only in the area affected by the Subzone)	Overlay (applies only in the area affected by the Overlay)
Advertisement Except where any of the following apply: <ul style="list-style-type: none"> Coastal Areas Overlay Hazards (Acid Sulfate Soils) Overlay Local Heritage Place Overlay Marine Parks (Managed Use) Overlay Marine Parks (Restricted Use) Overlay Ramsar Wetlands Overlay River Murray Flood Plain Overlay Sloping Land Overlay State Heritage Place Overlay State Significant Native Vegetation Overlay Water Protection Area Overlay 	None	Clearance from Overhead Powerlines: DTS 1.1 Advertisements [Appearance]: DTS 1.1, 1.3, 1.4 Advertisements [Proliferation of Advertisements]: DTS 2.1, 2.2 Advertisements [Advertising Content]: DTS 3.1 Advertisements [Amenity Content]: DTS 4.1 Advertising [Safety]: DTS 5.1, 5.2, 5.3, 5.4, 5.5	None	Airport Building Heights (Regulated): DTS 1.1, 1.2 Building Near Airfields: DTS 1.1, 1.2 Hazards (Acid Sulfate Soils): DTS 1.1 Key Outback and Rural Routes: 8.1 Native Vegetation: DTS 1.1 Urban Transport Routes: DTS 8.1

Class of Development The following Classes of Development are classified as Deemed-to-Satisfy Development subject to meeting the 'Deemed-to-Satisfy Development Classification Criteria'	Deemed-to-Satisfy Development Classification Criteria Provisions referred to are Deemed-to-Satisfy Criteria Where a development comprises more than one Class of Development the relevant criteria will be taken to be the sum of the criteria for each Class of Development.			
	Zone	General Development Policies	Subzone (applies only in the area affected by the Subzone)	Overlay (applies only in the area affected by the Overlay)
<ul style="list-style-type: none"> Water Resources Overlay 				
Carport Except where any of the following apply: <ul style="list-style-type: none"> Coastal Areas Overlay Hazards (Acid Sulfate Soils) Overlay Key Outback and Rural Routes Overlay Local Heritage Place Overlay Marine Parks (Managed Use) Overlay Marine Parks (Restricted Use) Overlay Ramsar Wetlands Overlay River Murray Flood Plain Overlay Sloping Land Overlay State Heritage Place Overlay State Significant Native Vegetation Overlay Water Protection Area Overlay Water Resources Overlay 	[Ancillary Structures]: DTS 6.1	Design in Urban Areas [All Residential Development – Ancillary Development]: DTS 17.1, 17.2 Design in Urban Areas [Residential Development – 3 Building Levels or Less – External Appearance]: DTS 19.1 Design in Urban Areas [Residential Development – 3 Building Levels or Less – Car parking, Access and Manoeuvrability]: All Infrastructure and Renewable Energy Facilities [Wastewater Services]: DTS 12.2 Transport, Access and Parking [Vehicle Access]: DTS 3.1, 3.4, 3.5	None	Airport Building Heights (Regulated): DTS 1.1, 1.2 Building Near Airfields: DTS 1.1, 1.2 Hazards (Acid Sulfate Soils): DTS 1.1 Key Outback and Rural Routes: All Native Vegetation: DTS 1.1 Urban Transport Routes: All
Outbuilding (in the form of a garage) Except where any of the following apply: <ul style="list-style-type: none"> Coastal Areas Overlay Hazards (Acid Sulfate Soils) Overlay Key Outback and Rural Routes Overlay Local Heritage Place Overlay Marine Parks (Managed Use) Overlay Marine Parks (Restricted Use) Overlay Ramsar Wetlands Overlay River Murray Flood Plain Overlay Sloping Land Overlay State Heritage Place Overlay 	[Ancillary Structures]: DTS 6.1	Design in Urban Areas [All Residential Development – Ancillary Development]: DTS 17.1, 17.2 Design in Urban Areas [Residential Development – 3 Building Levels or Less – External Appearance]: DTS 19.1 Design in Urban Areas [Residential Development – 3 Building Levels or Less – Car parking, Access and Manoeuvrability]: All Infrastructure and Renewable Energy Facilities [Wastewater Services]: DTS 12.2 Transport, Access and Parking [Vehicle Access]: DTS 3.1, 3.4, 3.5	None	Airport Building Heights (Regulated): DTS 1.1, 1.2 Building Near Airfields: DTS 1.1, 1.2 Hazards (Acid Sulfate Soils): DTS 1.1 Key Outback and Rural Routes: All Native Vegetation: DTS 1.1 Urban Transport Routes: All

Class of Development The following Classes of Development are classified as Deemed-to-Satisfy Development subject to meeting the 'Deemed-to-Satisfy Development Classification Criteria'	Deemed-to-Satisfy Development Classification Criteria Provisions referred to are Deemed-to-Satisfy Criteria Where a development comprises more than one Class of Development the relevant criteria will be taken to be the sum of the criteria for each Class of Development.			
	Zone	General Development Policies	Subzone (applies only in the area affected by the Subzone)	Overlay (applies only in the area affected by the Overlay)
<ul style="list-style-type: none"> State Significant Native Vegetation Overlay Water Protection Area Overlay Water Resources Overlay 				
Outbuilding (not being a garage) Except where any of the following apply: <ul style="list-style-type: none"> Coastal Areas Overlay Hazards (Acid Sulfate Soils) Overlay Local Heritage Place Overlay Marine Parks (Managed Use) Overlay Marine Parks (Restricted Use) Overlay Ramsar Wetlands Overlay River Murray Flood Plain Overlay Sloping Land Overlay State Heritage Place Overlay State Significant Native Vegetation Overlay Water Protection Area Overlay Water Resources Overlay 	[Ancillary Structures]: DTS 6.1	Design in Urban Areas [All Residential Development – Ancillary Development]: DTS 17.1, 17.2 Infrastructure and Renewable Energy Facilities [Wastewater Services]: DTS 12.2	None	Airport Building Heights (Regulated): DTS 1.1, 1.2 Building Near Airfields: DTS 1.1, 1.2 Hazards (Acid Sulfate Soils): DTS 1.1 Native Vegetation: DTS 1.1 Key Outback and Rural Routes: 8.1 Urban Transport Routes: DTS 8.1
Verandah Except where any of the following apply: <ul style="list-style-type: none"> Coastal Areas Overlay Hazards (Acid Sulfate Soils) Overlay Local Heritage Place Overlay Marine Parks (Managed Use) Overlay Marine Parks (Restricted Use) Overlay Ramsar Wetlands Overlay River Murray Flood Plain Overlay Sloping Land Overlay State Heritage Place Overlay 	[Ancillary Structures]: DTS 6.1	Design in Urban Areas [All Residential Development – Ancillary Development]: DTS 17.1, 17.2 Infrastructure and Renewable Energy Facilities [Wastewater Services]: DTS 12.2	None	Airport Building Heights (Regulated): DTS 1.1, 1.2 Building Near Airfields: DTS 1.1, 1.2 Hazards (Acid Sulfate Soils): DTS 1.1 Native Vegetation: DTS 1.1 Key Outback and Rural Routes: 8.1 Urban Transport Routes: DTS 8.1

Class of Development The following Classes of Development are classified as Deemed-to-Satisfy Development subject to meeting the 'Deemed-to-Satisfy Development Classification Criteria'	Deemed-to-Satisfy Development Classification Criteria			
	Zone	General Development Policies	Subzone (applies only in the area affected by the Subzone)	Overlay (applies only in the area affected by the Overlay)
<ul style="list-style-type: none"> State Significant Native Vegetation Overlay Water Protection Area Overlay Water Resources Overlay 				

Table 3 - Performance Assessed Development

Class of Development	Applicable Policies			
	Zone	General Development Policies	Subzone (applies only in the area affected by the Subzone)	Overlay (applies only in the area affected by the Overlay)
<p>The following policies are applicable to the assessment of the identified Class of Development.</p> <p>Policies referred to are Performance Outcome policies, and any associated Designated Performance Features. Relevant Desired Outcomes are not listed, but automatically apply in relation to a Performance Assessed Development.</p> <p>Where a development comprises more than one Class of Development the relevant policies will be taken to be the sum of the applicable policies for each Class of Development.</p>				
Carpport	[Built Form and Character]: PO 2.1 [Ancillary Structures]: PO 6.1	Design in Urban Areas [All Residential Development – Ancillary Development]: PO 17.1, 17.2 Design in Urban Areas [Residential Development – 3 Building Levels or Less – External Appearance]: PO 19.1 Design in Urban Areas [Residential Development – 3 Building Levels or Less – Car parking, Access and Manoeuvrability]: All Infrastructure and Renewable Energy Facilities [Wastewater Services]: PO 12.2 Transport, Access and Parking [Vehicle Access]: PO 3.1, 3.4, 3.5	None	Airport Building Heights (Regulated): All Building Near Airfields: All Coastal Areas: All Hazards (Acid Sulfate Soils): All Key Outback and Rural Routes: All Local Heritage Place: All Marine Parks (Managed Use): All Marine Parks (Restricted Use): All Native Vegetation: All Sloping Land: All State Heritage Place: All State Significant Native Vegetation: All Urban Transport Routes: All Water Protection Area: All Water Resources: All
Demolition of a State or Local Heritage Place	None	None	None	State Heritage Place: All Local Heritage Place: All
Dwelling addition	[Built Form and	Clearance from Overhead Powerlines: PO 1.1	None	Airport Building Heights (Regulated): All

	<p>Character]: PO 2.1, 2.2, 2.3, 2.4, 2.5, 2.6 [Hazard Risk Avoidance]: PO 3.1</p>	<p>Infrastructure and Renewable Energy Facilities [Water Supply]: PO 11.2</p> <p>Infrastructure and Renewable Energy Facilities [Wastewater Services]: PO 12.1, 12.2</p> <p>Design in Urban Areas [All Residential Development – External Appearance]: PO 14.1</p> <p>Design in Urban Areas [All Residential Development – Outlook and Amenity]: PO 15.1</p> <p>Design in Urban Areas [All Residential Development – 3 Building Levels or Less – External Appearance]: PO 19.1, 19.2, 19.3</p> <p>Design in Urban Areas [All Residential Development – 3 Building Levels or Less – Overlooking / Visual Privacy]: PO 20.1</p> <p>Design in Urban Areas [All Residential Development – 3 Building Levels or Less –Private Open Space]: PO 21.1, 21.2, 21.3</p> <p>Design in Urban Areas [All Residential Development – 3 Building Levels or Less – Landscaping]: PO 22.1, 22.2</p> <p>Design in Urban Areas [All Residential Development – 3 Building Levels or Less – Waste Storage]: PO 25.1</p> <p>Interface Between Land Uses [Overshadowing]: PO 3.1, 3.2</p> <p>Interface Between Land Uses [Activities Generating Noise or Vibration]: PO 4.4</p> <p>Site Contamination: PO 1.1</p>		<p>Building Near Airfields: All</p> <p>Coastal Areas: All</p> <p>Hazards (Acid Sulfate Soils): All</p> <p>Key Outback and Rural Routes: All</p> <p>Local Heritage Place: All</p> <p>Marine Parks (Managed Use): All</p> <p>Marine Parks (Restricted Use): All</p> <p>Native Vegetation: All</p> <p>Sloping Land: All</p> <p>State Heritage Place: All</p> <p>State Significant Native Vegetation: All</p> <p>Urban Transport Routes: All</p> <p>Water Protection Area: All</p> <p>Water Resources: All</p>
Detached dwelling	<p>[Land Use and Intensity]: PO 1.1</p> <p>[Built Form and Character]: PO 2.1, 2.2, 2.3, 2.4, 2.5, 2.6 [Hazard Risk Avoidance]: PO 3.1</p> <p>[Environment]: PO 4.1</p>	<p>Clearance from Overhead Powerlines: PO 1.1</p> <p>Infrastructure and Renewable Energy Facilities [Water Supply]: PO 11.2</p> <p>Infrastructure and Renewable Energy Facilities [Wastewater Services]: PO 12.1, 12.2</p> <p>Transport, Access and Parking [Vehicle Access]: PO 3.1, 3.5, 3.6</p> <p>Transport, Access and Parking [Vehicle Parking Rates]: PO 5.1</p> <p>Design in Urban Areas [All Development – Car Parking Appearance]: PO 6.1</p> <p>Design in Urban Areas [All Residential Development – External Appearance]: PO 14.1, 14.2</p> <p>Design in Urban Areas [All Residential Development – Outlook and Amenity]: PO 15.1</p> <p>Design in Urban Areas [All Residential Development – Access and Servicing]: PO 16.1</p> <p>Design in Urban Areas [All Residential Development – Flooding]: PO 18.1</p>	None	<p>Airport Building Heights (Regulated): All</p> <p>Building Near Airfields: All</p> <p>Coastal Areas: All</p> <p>Hazards (Acid Sulfate Soils): All</p> <p>Hazards (Bushfire – High Risk): All</p> <p>Hazards (Bushfire - Medium Risk): All</p> <p>Hazards (Bushfire - General Risk): All</p> <p>Hazard (Bushfire - Urban Interface): All</p> <p>Hazards (Bushfire - Regional): All</p> <p>Key Outback and Rural Routes: All</p> <p>Local Heritage Place: All</p> <p>Marine Parks (Managed Use): All</p> <p>Marine Parks (Restricted Use): All</p> <p>Murray Darling Basin: All</p> <p>Native Vegetation: All</p>

		<p>Design in Urban Areas [All Residential Development – 3 Building Levels or Less – External Appearance]: PO 19.1, 19.2, 19.3</p> <p>Design in Urban Areas [All Residential Development – 3 Building Levels or Less – Overlooking / Visual Privacy]: PO 20.1</p> <p>Design in Urban Areas [All Residential Development – 3 Building Levels or Less –Private Open Space]: PO 21.1, 21.2, 21.3</p> <p>Design in Urban Areas [All Residential Development – 3 Building Levels or Less – Landscaping]: PO 22.1, 22.2</p> <p>Design in Urban Areas [All Residential Development – 3 Building Levels or Less – Water Sensitive Design]: PO 23.1, 23.2, 23.3</p> <p>Design in Urban Areas [All Residential Development – 3 Building Levels or Less – Car Parking and Manoeuvrability]: PO 24.1, 24.2, 24.3, 24.4, 24.5, 24.6</p> <p>Design in Urban Areas [All Residential Development – 3 Building Levels or Less – Waste Storage]: PO 25.1</p> <p>Interface Between Land Uses [Overshadowing]: PO 3.1, 3.2</p> <p>Interface Between Land Uses [Interface Between Rural Activities]: PO 9.3, 9.4, 9.5</p> <p>Interface Between Land Uses [Interface with Mines and Quarries (Rural and Remote Areas): PO 10.1</p> <p>Site Contamination: PO 1.1</p>		<p>Prescribed Water Resources Area: All</p> <p>Prescribed Wells Area: All</p> <p>Ramsar Wetlands: All</p> <p>River Murray Flood Plain: All</p> <p>Sloping Land: All</p> <p>State Heritage Place: All</p> <p>State Significant Native Vegetation: All</p> <p>Urban Transport Routes: All</p> <p>Water Protection Area: All</p> <p>Water Resources: All</p>
Outbuilding (in the form of a garage)	<p>[Built Form and Character]: PO 2.1</p> <p>[Ancillary Structures]: PO 6.1</p>	<p>Design in Urban Areas [All Residential Development – Ancillary Development]: PO 17.1, 17.2</p> <p>Design in Urban Areas [Residential Development – 3 Building Levels or Less – External Appearance]: PO 19.1</p> <p>Design in Urban Areas [Residential Development – 3 Building Levels or Less – Car parking, Access and Manoeuvrability]: All</p> <p>Infrastructure and Renewable Energy Facilities [Wastewater Services]: PO 12.2</p> <p>Transport, Access and Parking [Vehicle Access]: PO 3.1, 3.4, 3.5</p>	None	<p>Airport Building Heights (Regulated): All</p> <p>Building Near Airfields: All</p> <p>Coastal Areas: All</p> <p>Hazards (Acid Sulfate Soils): All</p> <p>Key Outback and Rural Routes: All</p> <p>Local Heritage Place: All</p> <p>Marine Parks (Managed Use): All</p> <p>Marine Parks (Restricted Use): All</p> <p>Native Vegetation: All</p> <p>Sloping Land: All</p> <p>State Heritage Place: All</p> <p>State Significant Native Vegetation: All</p> <p>Urban Transport Routes: All</p> <p>Water Protection Area: All</p> <p>Water Resources: All</p>
All other Code Assessed Development	All	All	None	Any Relevant Overlay: All

Table 4 – Restricted Development Classification

Class of Development The following Classes of Development are classified as Restricted subject to any 'Exclusions'	Exclusions
Dwelling	A detached dwelling that will not result in more than one dwelling on an allotment.
Land division	Except where it involves one or more of the following: <ul style="list-style-type: none"> (a) each allotment created contains an existing dwelling; (b) the creation of a public road or a public reserve; (c) a minor adjustment of allotment boundaries to remove an anomaly in the current boundaries with respect to the location of existing buildings or structures and where no additional allotments are created partly or wholly in the zone.

Assessment Provisions (AP)

Desired Outcome (DO)

DO 1

Limited shack development within an environment where natural processes such as flooding, sea-level rise, sand drift and erosion occur. The natural environment is protected from inappropriate development and existing development is upgraded to incorporate environmental improvements.

Performance Outcomes and Deemed to Satisfy / Designated Performance Outcome Criteria

Land Use and Intensity

PO 1.1

Low-scale and low-density residential development in the form of detached dwellings sympathetic to the surrounding natural environment.

DTS/DPF 1.1

No more than one dwelling per allotment.

PO 1.2

Provision of small-scale tourist and visitor facilities such as public amenities and barbeque and picnic infrastructure.

DTS/DPF 1.2

None applicable

Built Form and Character

PO 2.1

Development sited and designed unobtrusively to minimise its visual impact on the natural environment by:

- (a) using low reflective materials and finishes that blend with, and colours that complement, the surrounding landscape;
- (b) being located below hilltops and ridgelines; and
- (c) being screened by existing vegetation.

DTS/DPF 2.1

None are applicable

PO 2.2

Development sited and designed to minimise impacts on the natural environment by:

- (a) containing construction and built form within a tightly defined site boundary; and
- (b) minimising the extent of earthworks

DTS/DPF 2.2

None are applicable

PO 2.3

Additions or alterations to, or replacement of an existing dwelling blend with the natural environment, other than where required to be on poles or piers in order to increase the elevation to minimise the potential for personal or property damage as a result of inundation.

DTS/DPF 2.3

Additions or alterations to, or replacement of an existing dwelling have a building height that is no greater than 1 building level and 6m and a wall height that is no greater than 3m.

PO 2.4

Buildings set back from the primary street boundary to complement the existing settlement character.

DTS/DPF 2.4

None are applicable.

Procedural Matters (PM)

Notification of Performance assessed development

All classes of performance assessed development is excluded from notification except where they involve any of the following:

- (a) the site of the development is adjacent land to land in a different zone
- (b) development identified as "all other code assessed development" in Shack Settlement Zone Table 3
- (c) buildings exceeding 2 building levels or over 9m in height
- (d) development involving the creation of four or more additional dwellings or allotments
- (e) shop, office, or consulting room in excess of 100m² in gross leasable floor area
- (f) hotel
- (g) light industry, warehouse or store where the gross leasable floor area of the buildings plus any outdoor space used for any of these uses exceeds 80m².

Rural Living Zone

Table 1 – Accepted Development Classification

Class of Development The following Classes of Development are classified as Accepted Development subject to meeting the 'Accepted Development Classification Criteria'	Accepted Development Classification Criteria
Building work on railway land Except where any of the following apply:	7 Building work is associated with a railway 8 It is situated (or to be situated) on railway land 9 It is required for the conduct or maintenance of railway activities.
Carport Except where any of the following apply: <ul style="list-style-type: none"> • Character Preservation District Overlay • Coastal Areas Overlay • Hazards (Acid Sulfate Soils) Overlay • Hazards (Flooding) Overlay • Historic Area Overlay • Local Heritage Place Overlay • State Heritage Area Overlay • State Heritage Place Overlay • Native Vegetation Overlay • State Significant Native Vegetation Overlay • Significant Landscape Protection Overlay • Ramsar Wetlands Overlay 	26 The development will not be built, or encroach, on an area that is, or will be, required for a sewerage system or waste control system 27 It is ancillary to a dwelling erected on the site 28 Primary street setback – at least 5.5m from the primary street boundary and as far back as the building line of the building to which it is ancillary 29 Secondary street setback – at least 900mm from the boundary of the allotment (if the land has boundaries on two or more roads) 30 Total floor area - does not exceed 40m ² 31 Post height - does not exceed 3m measured from natural ground level (and not including a gable end) 32 Building height - does not exceed 5m 33 If situated on or abutting a boundary (not being a boundary with a primary street or secondary street) – a length not exceeding 10m unless: <ul style="list-style-type: none"> (a) a longer wall or structure exists on the adjacent site and is situated on the same allotment boundary; and

Class of Development The following Classes of Development are classified as Accepted Development subject to meeting the 'Accepted Development Classification Criteria'	Accepted Development Classification Criteria
<ul style="list-style-type: none"> • River Murray Flood Plain Overlay • Sloping Land Overlay • Key Railway Crossings Overlay where an existing access is altered or a new access is created • Key Outback and Rural Routes Overlay where an existing access is altered or a new access is created • Major Urban Transport Routes Overlay where an existing access is altered or a new access is created • Non-stop Corridor Overlay where an existing access is altered or a new access is created • Urban Transport Routes Overlay where an existing access is altered or a new access is created • Water Resources Overlay 	<p>(b) the proposed wall or structure will be built along the same length of boundary as the existing adjacent wall or structure to the same or lesser extent</p> <p>34 If the carport abuts or is situated on the boundary of the allotment (not being a boundary with a primary street or secondary street):</p> <p>(a) it will not result in all relevant walls or structures located along the boundary exceeding 45% of the length of the boundary; and</p> <p>(b) it will not be located within 3m of any other wall along the same boundary unless on an adjacent site on that boundary there is an existing wall of a building that would be adjacent to or abut the proposed wall or structure</p> <p>35 The total roofed area of all existing or proposed buildings on the allotment does not exceed 60% of the area of the allotment</p> <p>36 Door opening for vehicle access – does not exceed, in total, 7m in width or 50% of the width of the allotment frontage (whichever lesser)</p> <p>37 Internal dimensions – does not exceed 3.2m in width and 6m in length between all fences, walls and doors</p> <p>38 The carport:</p> <p>(a) is located so that vehicle access:</p> <p style="padding-left: 20px;">i. is provided via a lawfully existing or authorised driveway or access point or an access point for which consent has been granted as part of an application for the division of land; or</p> <p style="padding-left: 20px;">ii. will use a driveway that:</p> <p style="padding-left: 40px;">A. is not located within 6 metres of an intersection of 2 or more roads or a pedestrian actuated crossing; and</p> <p style="padding-left: 40px;">B. will not interfere with an item of street furniture (including directional signs, lighting, seating and weather shelters), other infrastructure, or a tree; or</p>

Class of Development The following Classes of Development are classified as Accepted Development subject to meeting the 'Accepted Development Classification Criteria'	Accepted Development Classification Criteria
	<p>iii. if adjacent a kerbed road, will be via a kerb that is designed to allow a vehicle to roll over it; and</p> <p>(b) is located so that the gradient from the place of access on the boundary of the allotment to the finished floor level at the front of the carport when the work is completed is not steeper than 1:4 on average; and</p> <p>(c) The centre of the driveway at the public road boundary is no more than 25 degree deviation from the centre of the front of the covered car parking space for which it provides vehicle access</p>
Demolition Except where any of the following apply: <ul style="list-style-type: none"> • Historic Area Overlay • Local Heritage Place identified in the Local Heritage Place Overlay • State Heritage Area Overlay • State Heritage Place identified in the State Heritage Place Overlay 	None.
Internal building work Except where any of the following apply: <ul style="list-style-type: none"> • Local Heritage Place identified in the Local Heritage Place Overlay • State Heritage Area Overlay 	7 There will be no increase in the total floor area of the building 8 There will be no alteration to the external appearance of the building.

Class of Development The following Classes of Development are classified as Accepted Development subject to meeting the 'Accepted Development Classification Criteria'	Accepted Development Classification Criteria
<ul style="list-style-type: none"> State Heritage Place identified in the State Heritage Place Overlay. 	
<p>Outbuilding (in the form of a garage)</p> <p>Except where any of the following apply:</p> <ul style="list-style-type: none"> Character Preservation District Overlay Coastal Areas Overlay Hazards (Acid Sulfate Soils) Overlay Hazards (Flooding) Overlay Historic Area Overlay Local Heritage Place Overlay State Heritage Area Overlay State Heritage Place Overlay Native Vegetation Overlay State Significant Native Vegetation Overlay Significant Landscape Protection Overlay Ramsar Wetlands Overlay River Murray Flood Plain Overlay Sloping Land Overlay Key Railway Crossings Overlay where an existing access is altered or a new access is created 	<p>29 The development will not be built, or encroach, on an area that is, or will be, required for a sewerage system or waste control system</p> <p>30 It is detached from and ancillary to a dwelling erected on the site.</p> <p>31 Primary street setback – at least 5.5m from the primary street boundary and as far back as the building line of the building to which it is ancillary</p> <p>32 Secondary street setback – at least 900mm from the boundary of the allotment (if the land has boundaries on two or more roads)</p> <p>33 Total floor area - does not exceed 60m²</p> <p>34 Wall height - does not exceed 3m measured from natural ground level (and not including a gable end)</p> <p>35 Building height - does not exceed 5m</p> <p>36 If situated on or abutting a boundary (not being a boundary with a primary street or secondary street) – a length not exceeding 10m unless:</p> <p>(a) a longer wall or structure exists on the adjacent site and is situated on the same allotment boundary; and</p> <p>(b) the proposed wall or structure will be built along the same length of boundary as the existing adjacent wall or structure to the same or lesser extent</p> <p>37 If the outbuilding abuts or is situated on the boundary of the allotment (not being a boundary with a primary street or secondary street):</p> <p>(a) it will not result in all relevant walls or structures located along the boundary exceeding 45% of the length of the boundary; and</p>

Class of Development The following Classes of Development are classified as Accepted Development subject to meeting the 'Accepted Development Classification Criteria'	Accepted Development Classification Criteria
<ul style="list-style-type: none"> • Key Outback and Rural Routes Overlay where an existing access is altered or a new access is created • Major Urban Transport Routes Overlay where an existing access is altered or a new access is created • Non-stop Corridor Overlay where an existing access is altered or a new access is created • Urban Transport Routes Overlay where an existing access is altered or a new access is created • Water Resources Overlay 	<p>(b) it will not be located within 3m of any other wall along the same boundary unless on an adjacent site on that boundary there is an existing wall of a building that would be adjacent to or abut the proposed wall or structure</p> <p>38 Total roofed area of all existing and proposed buildings on the allotment - does not exceed 60%</p> <p>39 Internal dimensions – exceed 3.2m in width and 6m in length between all walls and doors</p> <p>40 Door opening for vehicle access – does not exceed, in total, 7m in width or 50% of the width of the allotment frontage (whichever lesser)</p> <p>41 The garage:</p> <ul style="list-style-type: none"> (a) is located so that vehicle access: <ul style="list-style-type: none"> i. is provided via a lawfully existing or authorised driveway or access point or an access point for which consent has been granted as part of an application for the division of land; or ii. will use a driveway that: <ul style="list-style-type: none"> A. is not located within 6 metres of an intersection of 2 or more roads or a pedestrian actuated crossing; and B. will not interfere with an item of street furniture (including directional signs, lighting, seating and weather shelters), other infrastructure, or a tree; or iii. if adjacent a kerbed road, will be via a kerb that is designed to allow a vehicle to roll over it; and (b) is located so that the gradient from the place of access on the boundary of the allotment to the finished floor level at the front of the carport when the work is completed is not steeper than 1:4 on average; and (c) The centre of the driveway at the public road boundary is no more than 25 degree deviation from the centre of the front of the covered car parking space for which it provides vehicle access <p>42 If clad in sheet metal—is pre-colour treated or painted in a non-reflective colour.</p>

Class of Development The following Classes of Development are classified as Accepted Development subject to meeting the 'Accepted Development Classification Criteria'	Accepted Development Classification Criteria
<p>Outbuilding (not being a garage)</p> <p>Except where any of the following apply:</p> <ul style="list-style-type: none"> • Character Preservation District Overlay • Coastal Areas Overlay • Hazards (Acid Sulfate Soils) Overlay • Hazards (Flooding) Overlay • Historic Area Overlay • Local Heritage Place Overlay • State Heritage Area Overlay • State Heritage Place Overlay • Native Vegetation Overlay • State Significant Native Vegetation Overlay • Significant Landscape Protection Overlay • Ramsar Wetlands Overlay • River Murray Flood Plain Overlay • Sloping Land Overlay • Water Resources Overlay. 	<p>24 The development will not be built, or encroach, on an area that is, or will be, required for a sewerage system or waste control system</p> <p>25 It is detached from and ancillary to a dwelling erected on the site</p> <p>26 Primary street setback – at least as far back as the building line of the building to which it is ancillary</p> <p>27 Secondary street setback – at least 900mm from the boundary of the allotment (if the land has boundaries on two or more roads)</p> <p>28 Side boundary setbacks – at least 900mm from the boundary of the allotment</p> <p>29 Total floor area does not exceed 60m²</p> <p>30 Wall height - does not exceed 3m measured from natural ground level (and not including a gable end)</p> <p>31 Building height - does not exceed 5m</p> <p>32 If situated on or abutting a boundary (not being a boundary with a primary street or secondary street) – a length not exceeding 10m unless:</p> <p>(a) a longer wall or structure exists on the adjacent site and is situated on the same allotment boundary; and</p> <p>(b) the proposed wall or structure will be built along the same length of boundary as the existing adjacent wall or structure to the same or lesser extent</p> <p>33 If the outbuilding abuts or is situated on the boundary of the allotment (not being a boundary with a primary street or secondary street):</p> <p>(a) it will not result in all relevant walls or structures located along the boundary exceeding 45% of the length of the boundary; and</p> <p>(b) will not be located within 3m of any other wall along the same boundary unless on an adjacent site on that boundary there is an existing wall of a building that would be adjacent to or abut the proposed wall or structure</p>

Class of Development The following Classes of Development are classified as Accepted Development subject to meeting the 'Accepted Development Classification Criteria'	Accepted Development Classification Criteria
	34 Total roofed area of all existing and proposed buildings on the allotment - does not exceed 60% 35 If clad in sheet metal—is pre-colour treated or painted in a non-reflective colour.
Private bushfire shelters Except where any of the following apply: <ul style="list-style-type: none"> • Character Preservation District Overlay • Coastal Areas Overlay • Hazards (Acid Sulfate Soils) Overlay • Hazards (Flooding) Overlay • Historic Area Overlay • Local Heritage Place Overlay • State Heritage Area Overlay • State Heritage Place Overlay • Native Vegetation Overlay • State Significant Native Vegetation Overlay • Significant Landscape Protection Overlay • Ramsar Wetlands Overlay • River Murray Flood Plain Overlay • Sloping Land Overlay • Water Resources Overlay 	9 The development will not be built, or encroach, on an area that is, or will be, required for a sewerage system or waste control system 10 Primary street setback – at least as far back as the building to which it is ancillary 11 Secondary street setback – at least 900mm from the boundary of the allotment 12 At least 6m from the corner of an allotment which abuts the intersection of two or more roads (other than where a 4m x 4m allotment cut-off is already in place).
Shade sail Except where any of the following apply:	15 The development will not be built, or encroach, on an area that is, or will be, required for a sewerage system or waste control system

Class of Development The following Classes of Development are classified as Accepted Development subject to meeting the 'Accepted Development Classification Criteria'	Accepted Development Classification Criteria
<ul style="list-style-type: none"> • Character Preservation District Overlay • Coastal Areas Overlay • Hazards (Acid Sulfate Soils) Overlay • Historic Area Overlay • Local Heritage Place Overlay • State Heritage Area Overlay • State Heritage Place Overlay • Native Vegetation Overlay • State Significant Native Vegetation Overlay • Significant Landscape Protection Overlay • Ramsar Wetlands Overlay • River Murray Flood Plain Overlay • Sloping Land Overlay • Water Resources Overlay 	<p>16 Shade sail consists of permeable material</p> <p>17 The total area of the sail - does not exceed 40m²</p> <p>18 No part of the shade sail will be:</p> <p style="padding-left: 20px;">(a) 3m above ground or floor level (depending on where it is situated) at any place within 900mm of a boundary of the allotment</p> <p style="padding-left: 20px;">(b) 5m above ground or floor level (depending on where it is situated) within any other part of the allotment</p> <p>19 Primary street setback – at least as far back as the building line of the building to which it is ancillary</p> <p>20 If any part of the sail will be situated on a boundary of the allotment, the length of sail along a boundary does not exceed 8m</p> <p>21 In a case where any part of the sail or a supporting structure will be situated on a side boundary of the allotment – the length of the sail and any such supporting structure together with all relevant walls or structures located along the boundary will not exceed 45% of the length of the boundary.</p>
<p>Solar photovoltaic panels (roof mounted)</p> <p>Except where any of the following apply:</p> <ul style="list-style-type: none"> • Historic Area Overlay • Local Heritage Place identified in the Local Heritage Place Overlay • State Heritage Area Overlay • State Heritage Place identified in the State Heritage Place Overlay 	<p>7 Panels are installed parallel to the roof of a building and with the underside surface of the panel not being more than 100mm above the surface of the roof</p> <p>8 Panels and associated components do not overhang any part of the roof</p> <p>9 Does not apply to system with a generating capacity of more than 5MW that is to be connected to the State's power system.</p>

Class of Development The following Classes of Development are classified as Accepted Development subject to meeting the 'Accepted Development Classification Criteria'	Accepted Development Classification Criteria
<p>Spa pool</p> <p>Swimming pool</p> <p>Except where any of the following apply:</p> <ul style="list-style-type: none"> • Character Preservation District Overlay • Coastal Areas Overlay • Hazards (Acid Sulfate Soils) Overlay • Hazards (Flooding) Overlay • Historic Area Overlay • Local Heritage Place Overlay • State Heritage Area Overlay • State Heritage Place Overlay • Native Vegetation Overlay • State Significant Native Vegetation Overlay • Significant Landscape Protection Overlay • Ramsar Wetlands Overlay • River Murray Flood Plain Overlay • Sloping Land Overlay • Water Resources Overlay 	<p>36 The development will not be built, or encroach, on an area that is, or will be, required for a sewerage system or waste control system</p> <p>37 It is ancillary to a dwelling erected on the site</p> <p>38 Allotment boundary setback – not less than 1m</p> <p>39 Primary street setback – at least as far back as the building line of the building to which it is ancillary</p> <p>40 Location of filtration system from a dwelling on an adjoining allotment:</p> <p>(a) not less than 5m where the filtration system is located inside a solid structure that will have material impact on the transmission of noise</p> <p>(b) not less than 12m in any other case.</p>
<p>Verandah</p> <p>Except where any of the following apply:</p>	<p>16 The development will not be built, or encroach, on an area that is, or will be, required for a sewerage system or waste control system</p> <p>17 It is ancillary to a dwelling erected on the site</p> <p>18 Primary street setback – as far back as the building line of the building to which it is ancillary</p>

Class of Development The following Classes of Development are classified as Accepted Development subject to meeting the 'Accepted Development Classification Criteria'	Accepted Development Classification Criteria
<ul style="list-style-type: none"> • Character Preservation District Overlay • Coastal Areas Overlay • Hazards (Acid Sulfate Soils) Overlay • Hazards (Flooding) Overlay • Historic Area Overlay • Local Heritage Place Overlay • State Heritage Area Overlay • State Heritage Place Overlay • Native Vegetation Overlay • State Significant Native Vegetation Overlay • Ramsar Wetlands Overlay • River Murray Flood Plain Overlay • Water Resources Overlay 	<p>19 Total floor area - does not exceed 60m²</p> <p>20 Post height - does not exceed 3m measured from natural ground level</p> <p>21 Building height - does not exceed 5m</p> <p>22 Length - does not exceed 10m if any part of the structure abuts or is situated on a boundary of the allotment</p> <p>23 Total roofed area of all existing and proposed buildings on the allotment - does not exceed 60%.</p>
<p>Water tank (above ground)</p> <p>Except where any of the following apply:</p> <ul style="list-style-type: none"> • Character Preservation District Overlay • Coastal Areas Overlay • Hazards (Flooding) Overlay • Historic Area Overlay • Local Heritage Place Overlay • State Heritage Area Overlay • State Heritage Place Overlay • Native Vegetation Overlay 	<p>15 The development will not be built, or encroach, on an area that is, or will be, required for a sewerage system or waste control system</p> <p>16 The tank is part of a roof drainage system</p> <p>17 Total floor area - not exceeding 15m²</p> <p>18 The tank is located wholly above ground</p> <p>19 Tank height – does not exceed 4m above natural ground level</p> <p>20 Primary street setback – at least as far back as the building line of the building to which it is ancillary</p> <p>21 In the case of a tank made of metal – the tank is pre-colour treated or painted in a non-reflective colour.</p>

Class of Development The following Classes of Development are classified as Accepted Development subject to meeting the 'Accepted Development Classification Criteria'	Accepted Development Classification Criteria
<ul style="list-style-type: none"> • State Significant Native Vegetation Overlay • Significant Landscape Protection Overlay • Ramsar Wetlands Overlay • River Murray Flood Plain Overlay • Sloping Land Overlay • Water Resources Overlay 	
<p>Water tank (underground)</p> <p>Except where any of the following apply:</p> <ul style="list-style-type: none"> • Character Preservation District Overlay • Coastal Areas Overlay • Hazards (Acid Sulfate Soils) Overlay • Native Vegetation Overlay • State Significant Native Vegetation Overlay • Ramsar Wetlands Overlay • Sloping Land Overlay • Water Resources Overlay 	<ol style="list-style-type: none"> 5 The development will not be built, or encroach, on an area that is, or will be, required for a sewerage system or waste control system 6 The tank (including any associated pump) is located wholly below the level of the ground.

Table 2 – Deemed-to-Satisfy Development Classification

Class of Development	Deemed-to-Satisfy Development Classification Criteria			
	Zone	General Development Policies	Subzone	Overlay
<p>The following Classes of Development are classified as Deemed-to-Satisfy Development subject to meeting the 'Deemed-to-Satisfy Development Classification Criteria'</p>	<p>Provisions referred to are Deemed-to-Satisfy Criteria</p> <p>Where a development comprises more than one Class of Development the relevant criteria will be taken to be the sum of the criteria for each Class of Development.</p>			
<p>Advertisement</p> <p>Except where any of the following apply:</p> <ul style="list-style-type: none"> Advertising Near Signalised Intersections Overlay Character Preservation District Overlay Coastal Areas Overlay Hazards (Acid Sulfate Soils) Overlay Hazards (Flooding) Overlay Historic Area Overlay Local Heritage Place Overlay Marine Parks (Managed Use) Overlay Mt Lofty Ranges Catchment (Area 1) Overlay Mt Lofty Ranges Catchment (Area 2) Overlay Murray Darling Basin Overlay Native Vegetation Overlay Non-stop Corridor Overlay River Murray Flood Plain Overlay Significant Landscape Protection Overlay Sloping Land Overlay State Heritage Area Overlay State Heritage Place Overlay State Significant Native Vegetation Overlay 	None	<p>Clearance from Overhead Powerlines: DTS 1.1</p> <p>Advertisements [Appearance]: DTS 1.1, 1.3, 1.4</p> <p>Advertisements [Proliferation of Advertisements]: DTS 2.1, 2.2</p> <p>Advertisements [Advertising Content]: DTS 3.1</p> <p>Advertisements [Amenity Content]: DTS 4.1</p> <p>Advertising [Safety]: DTS 5.1, 5.2, 5.3, 5.4, 5.5</p>	None	<p>Airport Building Heights (Aircraft Landing Area): DTS 1.1</p> <p>Airport Building Heights (Regulated): DTS 1.1, 1.2</p> <p>Building Near Airfields: DTS 1.1, 1.2</p> <p>Defence Aviation Area: DTS 1.1, 1.3</p> <p>Hazards (Acid Sulfate Soils): DTS 1.1</p> <p>Future Road Widening: DTS 1.1</p> <p>Key Outback and Rural Routes: 8.1</p> <p>Major Urban Transport Routes: 8.1</p> <p>Native Vegetation: DTS 1.1</p> <p>Urban Transport Routes: 8.1</p>
<p>Carport</p> <p>Except where any of the following apply:</p> <ul style="list-style-type: none"> Character Preservation District Overlay Coastal Areas Overlay Defence Aviation Area Overlay Hazards (Acid Sulfate Soils) Overlay Hazards (Flooding) Overlay Historic Area Overlay Key Outback and Rural Routes Overlay Key Railway Crossings Overlay Limited Land Division Overlay Local Heritage Place Overlay Marine Parks (Managed Use) Overlay 	[Built Form and Character]: DTS 2.6	<p>Design in Rural Areas [All Residential Development – Ancillary Development]: DTS 13.1</p> <p>Design in Rural Areas [Residential Development – 3 Building Levels or Less – External Appearance]: DTS 14.1</p> <p>Design in Rural Areas [Residential Development – 3 Building Levels or Less – Car parking, Access and Manoeuvrability]: DTS 18.1, 18.3, 18.4, 18.5</p> <p>Infrastructure and Renewable Energy Facilities [Wastewater Services]: DTS 12.2</p> <p>Transport, Access and Parking [Vehicle Access]: DTS 3.1, 3.5</p>	None	<p>Airport Building Heights (Aircraft Landing Area): DTS 1.1</p> <p>Airport Building Heights (Regulated): DTS 1.1, 1.2</p> <p>Building Near Airfields: DTS 1.1, 1.2</p> <p>Defence Aviation Area: DTS 1.1, 1.3</p> <p>Future Road Widening: DTS 1.1</p> <p>Hazards (Acid Sulfate Soils): DTS 1.1</p> <p>Key Outback and Rural Routes: All</p> <p>Major Urban Transport Routes: All</p> <p>Native Vegetation: DTS 1.1</p>

Class of Development The following Classes of Development are classified as Deemed-to-Satisfy Development subject to meeting the 'Deemed-to-Satisfy Development Classification Criteria'	Deemed-to-Satisfy Development Classification Criteria Provisions referred to are Deemed-to-Satisfy Criteria Where a development comprises more than one Class of Development the relevant criteria will be taken to be the sum of the criteria for each Class of Development.			
	Zone	General Development Policies	Subzone (applies only in the area affected by the Subzone)	Overlay (applies only in the area affected by the Overlay)
<ul style="list-style-type: none"> • Mt Lofty Ranges Catchment (Area 1) Overlay • Mt Lofty Ranges Catchment (Area 2) Overlay • Murray Darling Basin Overlay • Native Vegetation Overlay • Non-stop Corridor Overlay • Prescribed Water Resources Area Overlay • Ramsar Wetlands Overlay • River Murray Flood Plain Overlay • Significant Landscape Protection Overlay • Sloping Land Overlay • State Heritage Area Overlay • State Heritage Place Overlay • State Significant Native Vegetation Overlay 				Urban Transport Routes: All
Detached dwelling Except where any of the following apply: <ul style="list-style-type: none"> • Aircraft Noise Exposure Overlay • Character Preservation District Overlay • Coastal Areas Overlay • Resource Extraction Protection Area Overlay • Hazards (Acid Sulfate Soils) Overlay • Hazards (Bushfire – High Risk) Overlay • Hazards (Bushfire - Medium Risk) Overlay • Hazards (Bushfire - General Risk) Overlay • Hazard (Bushfire - Urban Interface) Overlay • Hazards (Bushfire - Regional) Overlay • Hazards (Flooding) Overlay • Historic Area Overlay • Key Railway Crossings Overlay • Local Heritage Place Overlay • Marine Parks (Managed Use) Overlay • Mt Lofty Ranges Catchment (Area 1) Overlay • Mt Lofty Ranges Catchment (Area 2) Overlay • Murray Darling Basin Overlay 	[Land Use and Intensity]: DTS 1.1 [Built Form and Character]: DTS 2.1	Clearance from Overhead Powerlines: DTS 1.1 Design in Rural Areas [All Development - On-site Waste Treatment Systems]: DTS 6.1 Design in Rural Areas [All Residential Development – External Appearance]: DTS 10.1, 10.2 Design in Rural Areas [All Residential Development - Access and Servicing]: DTS 12.1 Design in Rural Areas [Residential Development – 3 Building Levels or Less – External Appearance]: DTS 14.1, 14.2, 14.3 Design in Rural Areas [Residential Development – 3 Building Levels or Less – Car Parking, Access and Manoeuvrability]: DTS 18.3, 18.4, 18.5 Infrastructure and Renewable Energy Facilities [Water Supply]: DTS 11.1 Infrastructure and Renewable Energy Facilities [Wastewater Services]: DTS 12.1, 12.2 Interface Between Land Uses [Interface with Mines and Quarries (Rural and Remote Areas): DTS 10.1 Site Contamination: DTS 1.1	None	Affordable Housing Overlay: DTS 1.1 Airport Building Heights (Aircraft Landing Area): DTS 1.1 Airport Building Heights (Regulated): DTS 1.1, 1.2 Building Near Airfields: DTS 1.1, 1.2 Defence Aviation Area: DTS 1.1, 1.3 Future Road Widening: DTS 1.1 Hazards (Acid Sulfate Soils): DTS 1.1 Key Outback and Rural Routes: All Major Urban Transport Routes: All Native Vegetation: DTS 1.1 Urban Transport Routes: All

Class of Development The following Classes of Development are classified as Deemed-to-Satisfy Development subject to meeting the 'Deemed-to-Satisfy Development Classification Criteria'	Deemed-to-Satisfy Development Classification Criteria Provisions referred to are Deemed-to-Satisfy Criteria Where a development comprises more than one Class of Development the relevant criteria will be taken to be the sum of the criteria for each Class of Development.			
	Zone	General Development Policies	Subzone (applies only in the area affected by the Subzone)	Overlay (applies only in the area affected by the Overlay)
<ul style="list-style-type: none"> • Native Vegetation Overlay • Noise and Air Emissions Overlay • Non-stop Corridor Overlay • Prescribed Water Resources Area Overlay • Prescribed Watercourses Overlay • Prescribed Wells Area Overlay • Ramsar Wetlands Overlay • River Murray Flood Plain Overlay • River Murray Tributaries Area Overlay • Significant Landscape Protection Overlay • Sloping Land Overlay • State Heritage Area Overlay • State Heritage Place Overlay • State Significant Native Vegetation Overlay • Water Protection Area Overlay • Water Resources Overlay 		Transport, Access and Parking [Vehicle Access]: DTS 3.1, 3.5, 3.6		
Dwelling addition Except where any of the following apply: <ul style="list-style-type: none"> • Character Preservation District Overlay • Coastal Areas Overlay • Resource Extraction Protection Area Overlay • Hazards (Acid Sulfate Soils) Overlay • Hazards (Flooding) Overlay • Historic Area Overlay • Key Railway Crossings Overlay • Local Heritage Place Overlay • Marine Parks (Managed Use) Overlay • Mt Lofty Ranges Catchment (Area 1) Overlay • Mt Lofty Ranges Catchment (Area 2) Overlay • Native Vegetation Overlay • Non-stop Corridor Overlay • Ramsar Wetlands Overlay • River Murray Flood Plain Overlay • Significant Landscape Protection Overlay • Sloping Land Overlay • State Heritage Area Overlay • State Heritage Place Overlay 	[Built Form and Character]: DTS 2.4	Clearance from Overhead Powerlines: DTS 1.1 Design in Rural Areas [All Development - On-site Waste Treatment Systems]: DTS 6.1 Design in Rural Areas [All Residential Development – External Appearance]: DTS 10.1	None	Airport Building Heights (Regulated): DTS 1.1, 1.2 Building Near Airfields: DTS 1.1, 1.2 Defence Aviation Area: DTS 1.1, 1.3 Hazards (Acid Sulfate Soils): DTS 1.1 Native Vegetation: DTS 1.1 Urban Transport Routes: 8.1 Key Outback and Rural Routes: 8.1 Major Urban Transport Routes: 8.1

Class of Development The following Classes of Development are classified as Deemed-to-Satisfy Development subject to meeting the 'Deemed-to-Satisfy Development Classification Criteria'	Deemed-to-Satisfy Development Classification Criteria Provisions referred to are Deemed-to-Satisfy Criteria Where a development comprises more than one Class of Development the relevant criteria will be taken to be the sum of the criteria for each Class of Development.			
	Zone	General Development Policies	Subzone (applies only in the area affected by the Subzone)	Overlay (applies only in the area affected by the Overlay)
<ul style="list-style-type: none"> State Significant Native Vegetation Overlay 				
Horse keeping Except where any of the following apply: <ul style="list-style-type: none"> Coastal Areas Overlay Marine Parks (Managed Use) Overlay Mt Lofty Ranges Catchment (Area 1) Overlay Mt Lofty Ranges Catchment (Area 2) Overlay Murray Darling Basin Overlay Prescribed Water Resources Area Overlay Prescribed Watercourses Overlay Prescribed Wells Area Overlay Ramsar Wetlands Overlay River Murray Flood Plain Overlay River Murray Tributaries Area Overlay Water Protection Area Overlay Water Resources Overlay 	[Land Use and Intensity]: DTS 1.2, 1.3 [Built Form and Character]: DTS 2.3	Animal Keeping and Horse Keeping [Horse Keeping]: DTS 2.2, 2.3, 2.4, 2.5	Animal Husbandry Subzone [Land Use and Intensity]: DTS 1.1, 1.3, 1.4	None
Outbuilding (in the form of a garage) Except where any of the following apply: <ul style="list-style-type: none"> Character Preservation District Overlay Coastal Areas Overlay Hazards (Flooding) Overlay Historic Area Overlay Local Heritage Place Overlay Marine Parks (Managed Use) Overlay Mt Lofty Ranges Catchment (Area 1) Overlay Mt Lofty Ranges Catchment (Area 2) Overlay Native Vegetation Overlay Non-stop Corridor Overlay Ramsar Wetlands Overlay River Murray Flood Plain Overlay Significant Landscape Protection Overlay Sloping Land Overlay State Heritage Area Overlay State Heritage Place Overlay 	[Built Form and Character]: DTS 2.5	Design in Rural Areas [All Residential Development – Ancillary Development]: DTS 13.1 Design in Rural Areas [Residential Development – 3 Building Levels or Less – External Appearance]: DTS 14.1 Design in Rural Areas [Residential Development – 3 Building Levels or Less – Car parking, Access and Manoeuvrability]: DTS 18.1, 18.3, 18.4, 18.5 Infrastructure and Renewable Energy Facilities [Wastewater Services]: DTS 12.2 Transport, Access and Parking [Vehicle Access]: DTS 3.1, 3.5	None	Airport Building Heights (Aircraft Landing Area): DTS 1.1 Airport Building Heights (Regulated): DTS 1.1, 1.2 Building Near Airfields: DTS 1.1, 1.2 Defence Aviation Area: DTS 1.1, 1.3 Future Road Widening: DTS 1.1 Hazards (Acid Sulfate Soils): DTS 1.1 Key Outback and Rural Routes: All Major Urban Transport Routes: All Native Vegetation: DTS 1.1 Urban Transport Routes: All

Class of Development The following Classes of Development are classified as Deemed-to-Satisfy Development subject to meeting the 'Deemed-to-Satisfy Development Classification Criteria'	Deemed-to-Satisfy Development Classification Criteria Provisions referred to are Deemed-to-Satisfy Criteria Where a development comprises more than one Class of Development the relevant criteria will be taken to be the sum of the criteria for each Class of Development.			
	Zone	General Development Policies	Subzone (applies only in the area affected by the Subzone)	Overlay (applies only in the area affected by the Overlay)
<ul style="list-style-type: none"> State Significant Native Vegetation Overlay Urban Transport Routes Overlay 				
Outbuilding (not being a garage) Except where any of the following apply: <ul style="list-style-type: none"> Character Preservation District Overlay Coastal Areas Overlay Hazards (Flooding) Overlay Historic Area Overlay Local Heritage Place Overlay Marine Parks (Managed Use) Overlay Mt Lofty Ranges Catchment (Area 1) Overlay Mt Lofty Ranges Catchment (Area 2) Overlay Native Vegetation Overlay Non-stop Corridor Overlay Ramsar Wetlands Overlay River Murray Flood Plain Overlay Significant Landscape Protection Overlay Sloping Land Overlay State Heritage Area Overlay State Heritage Place Overlay State Significant Native Vegetation Overlay 	[Built Form and Character]: DTS 2.5	Infrastructure and Renewable Energy Facilities [Wastewater Services]: DTS 12.2	None	Airport Building Heights (Regulated): DTS 1.1, 1.2 Building Near Airfields: DTS 1.1, 1.2 Defence Aviation Area: DTS 1.1, 1.3 Hazards (Acid Sulfate Soils): DTS 1.1 Native Vegetation: DTS 1.1 Urban Transport Routes: 8.1 Key Outback and Rural Routes: 8.1 Major Urban Transport Routes: 8.1
Shop Except where any of the following apply: <ul style="list-style-type: none"> Character Preservation District Overlay Coastal Areas Overlay Resource Extraction Protection Area Overlay Hazards (Acid Sulfate Soils) Overlay Hazards (Bushfire – High Risk) Overlay Hazards (Bushfire - Medium Risk) Overlay Hazards (Bushfire - General Risk) Overlay Hazard (Bushfire - Urban Interface) Overlay Hazards (Bushfire - Regional) Overlay Hazards (Flooding) Overlay 	[Land Use and Intensity]: DTS 1.5 [Built Form and Character]: DTS 2.2	Clearance from Overhead Powerlines: DTS 1.1 Design in Rural Areas [On-site Waste Treatment Systems]: DTS 6.1 Design in Rural Areas [Car Parking Appearance]: DTS 7.4, 7.5 Interface Between Land Uses [Hours of Operation]: DTS 2.1 Interface Between Land Uses [Activities Generating Noise or Vibration]: DTS 4.1, 4.6 Interface Between Lands Uses [Air Quality]: DTS 5.2 Infrastructure and Renewable Energy Facilities [Water Supply]: DTS 11.1	None	Airport Building Heights (Aircraft Landing Area): DTS 1.1 Airport Building Heights (Regulated): DTS 1.1, 1.2 Building Near Airfields: DTS 1.1, 1.2 Defence Aviation Area: DTS 1.1, 1.3 Future Road Widening: DTS 1.1 Hazards (Acid Sulfate Soils): DTS 1.1 Key Outback and Rural Routes: All Major Urban Transport Routes: All Native Vegetation: DTS 1.1 Urban Transport Routes: All

Class of Development The following Classes of Development are classified as Deemed-to-Satisfy Development subject to meeting the 'Deemed-to-Satisfy Development Classification Criteria'	Deemed-to-Satisfy Development Classification Criteria Provisions referred to are Deemed-to-Satisfy Criteria Where a development comprises more than one Class of Development the relevant criteria will be taken to be the sum of the criteria for each Class of Development.			
	Zone	General Development Policies	Subzone (applies only in the area affected by the Subzone)	Overlay (applies only in the area affected by the Overlay)
<ul style="list-style-type: none"> • Historic Area Overlay • Key Railway Crossings Overlay • Local Heritage Place Overlay • Marine Parks (Managed Use) Overlay • Mt Lofty Ranges Catchment (Area 1) Overlay • Mt Lofty Ranges Catchment (Area 2) Overlay • Murray Darling Basin Overlay • Native Vegetation Overlay • Non-stop Corridor Overlay • Prescribed Water Resources Area Overlay • Prescribed Watercourses Overlay • Prescribed Wells Area Overlay • Ramsar Wetlands Overlay • River Murray Flood Plain Overlay • River Murray Tributaries Area Overlay • Significant Landscape Protection Overlay • Sloping Land Overlay • State Heritage Area Overlay • State Heritage Place Overlay • State Significant Native Vegetation Overlay • Water Protection Area Overlay • Water Resources Overlay 		Infrastructure and Renewable Energy Facilities [Wastewater Services]: DTS 12.1, 12.2 Transport, Access and Parking [Movement Systems]: DTS 1.4 Transport, Access and Parking [Vehicle Access]: DTS 3.1, 3.5 Transport, Access and Parking [Vehicle Parking Rates]: DTS 5.1 Transport, Access and Parking [Vehicle Parking Areas]: DTS 6.1, 6.6		
Verandah Except where any of the following apply: <ul style="list-style-type: none"> • Character Preservation District Overlay • Coastal Areas Overlay • Defence Aviation Area Overlay • Hazards (Acid Sulfate Soils) Overlay • Hazards (Flooding) Overlay • Historic Area Overlay • Key Outback and Rural Routes Overlay • Key Railway Crossings Overlay • Limited Land Division Overlay • Local Heritage Place Overlay • Marine Parks (Managed Use) Overlay • Mt Lofty Ranges Catchment (Area 1) Overlay • Mt Lofty Ranges Catchment (Area 2) Overlay 	[Built Form and Character]: DTS 2.6	Infrastructure and Renewable Energy Facilities [Wastewater Services]: DTS 12.2	None	Airport Building Heights (Regulated): DTS 1.1, 1.2 Building Near Airfields: DTS 1.1, 1.2 Defence Aviation Area: DTS 1.1, 1.3 Hazards (Acid Sulfate Soils): DTS 1.1 Native Vegetation: DTS 1.1

Class of Development The following Classes of Development are classified as Deemed-to-Satisfy Development subject to meeting the 'Deemed-to-Satisfy Development Classification Criteria'	Deemed-to-Satisfy Development Classification Criteria Provisions referred to are Deemed-to-Satisfy Criteria Where a development comprises more than one Class of Development the relevant criteria will be taken to be the sum of the criteria for each Class of Development.			
	Zone	General Development Policies	Subzone (applies only in the area affected by the Subzone)	Overlay (applies only in the area affected by the Overlay)
<ul style="list-style-type: none"> • Murray Darling Basin Overlay • Native Vegetation Overlay • Non-stop Corridor Overlay • Prescribed Water Resources Area Overlay • Ramsar Wetlands Overlay • River Murray Flood Plain Overlay • Significant Landscape Protection Overlay • Sloping Land Overlay • State Heritage Area Overlay • State Heritage Place Overlay State Significant Native Vegetation Overlay				

Table 3 – Applicable Policies for Performance Assessed Development

Class of Development	Applicable Policies			
	Zone	General Development Policies	Subzone (applies only in the area affected by the Subzone)	Overlay (applies only in the area affected by the Overlay)
	<p>The following policies are applicable to the assessment of the identified Class of Development.</p> <p>Policies referred to are Performance Outcome policies, and any associated Designated Performance Features. Relevant Desired Outcomes are not listed, but automatically apply in relation to a Performance Assessed Development.</p> <p>Where a development comprises more than one Class of Development the relevant policies will be taken to be the sum of the applicable policies for each Class of Development.</p>			
Advertisement	[Land Use and Intensity] PO 1.4	<p>Clearance from Overhead Powerlines: PO 1.1</p> <p>Advertisements [Appearance]: PO 1.1, 1.3, 1.4</p> <p>Advertisements [Proliferation of Advertisements]: PO 2.1, 2.2</p> <p>Advertisements [Advertising Content]: PO 3.1</p> <p>Advertisements [Amenity Content]: PO 4.1</p> <p>Advertising [Safety]: PO 5.1, 5.2, 5.3, 5.4, 5.5</p>	None	<p>Advertising Near Signalised Intersections: All</p> <p>Airport Building Heights (Aircraft Landing Area): All</p> <p>Airport Building Heights (Regulated): All</p> <p>Building Near Airfields: All</p> <p>Character Preservation District: All</p> <p>Coastal Areas: All</p> <p>Defence Aviation Area: All</p> <p>Hazards (Acid Sulfate Soils): All</p> <p>Hazards (Flooding): All</p> <p>Historic Area: All</p> <p>Future Road Widening: All</p> <p>Key Outback and Rural Routes: All</p> <p>Local Heritage Place: All</p> <p>Marine Parks (Managed Use): All</p> <p>Major Urban Transport Routes: All</p> <p>Mt Lofty Ranges Catchment (Area 1): All</p> <p>Mt Lofty Ranges Catchment (Area 2): All</p> <p>Native Vegetation: All</p> <p>Non-stop Corridor: All</p> <p>River Murray Flood Plain: All</p> <p>Significant Landscape Protection: All</p> <p>Sloping Land: all</p> <p>State Heritage Area: All</p> <p>State Heritage Place: All</p> <p>State Significant Native Vegetation: All</p> <p>Urban Transport Routes: All</p>
Carport	[Built Form and Character]: PO 2.6	<p>Design in Rural Areas [All Residential Development – Ancillary Development]: PO 13.1</p> <p>Design in Rural Areas [Residential Development – 3 Building Levels or Less – External Appearance]: PO 14.1</p> <p>Design in Urban Areas [Residential Development – 3 Building Levels or Less – Car parking, Access and Manoeuvrability]: PO 18.1, 18.3, 18.4, 18</p> <p>Infrastructure and Renewable Energy Facilities [Wastewater Services]: PO 12.2</p> <p>Transport, Access and Parking [Vehicle Access]: PO 3.1, 3.5</p>	None	<p>Airport Building Heights (Aircraft Landing Area): All</p> <p>Airport Building Heights (Regulated): All</p> <p>Building Near Airfields: All</p> <p>Character Preservation District: All</p> <p>Coastal Areas: All</p> <p>Defence Aviation Area: All</p> <p>Hazards (Flooding): All</p> <p>Historic Area: All</p> <p>Key Outback and Rural Routes: All</p> <p>Local Heritage Place: All</p> <p>Major Urban Transport Routes: All</p> <p>Marine Parks (Managed Use): All</p> <p>Mt Lofty Ranges Catchment (Area 1): All</p> <p>Mt Lofty Ranges Catchment (Area 2): All</p>

Class of Development	Applicable Policies			
	Zone	General Development Policies	Subzone (applies only in the area affected by the Subzone)	Overlay (applies only in the area affected by the Overlay)
				Native Vegetation: All Non-stop Corridor: All Ramsar Wetlands: All River Murray Flood Plain: All River Murray Tributaries Area: All Significant Landscape Protection: All Sloping Land: All State Heritage Area: All State Heritage Place: All State Significant Native Vegetation: All Traffic Generating Development: All Urban Transport Routes: All
Demolition of a State or Local Heritage Place	None	None	None	State Heritage Place: All Local Heritage Place: All
Demolition with the Historic Area Overlay	All	None	None	Historic Area Overlay: All
Detached dwelling	[Land Use and Intensity]: PO 1.1 [Built Form and Character]: PO 2.1	Clearance from Overhead Powerlines: PO 1.1 Infrastructure and Renewable Energy Facilities [Water Supply]: PO 11.2 Infrastructure and Renewable Energy Facilities [Wastewater Services]: PO 12.1, 12.2 Transport, Access and Parking [Vehicle Access]: PO 3.1, 3.5, 3.6 Design in Rural Areas [All Development - On-site Waste Treatment Systems]: PO 6.1 Design in Rural Areas [All Residential Development – External Appearance]: PO 10.1, 10.2 Design in Rural Areas [All Residential Development - Outlook and Amenity] PO 11.1 Design in Rural Areas [All Residential Development - Access and Servicing]: PO 12.1 Design in Rural Areas [Residential Development – 3 Building Levels or Less – External Appearance]: PO 14.1, 14.2, 14.3 Design in Rural Areas [Residential Development – 3 Building Levels or Less – Car Parking, Access and	None	Advertising Near Signalised Intersections: All Affordable Housing: All Aircraft Noise Exposure: All Airport Building Heights (Aircraft Landing Area): All Airport Building Heights (Regulated): All Building Near Airfields: All Character Preservation District: All Coastal Areas: All Defence Aviation Area: All Environment and Food Production Area: All Resource Extraction Protection Area: All Hazards (Acid Sulfate Soils): All Hazards (Bushfire – High Risk): All Hazards (Bushfire - Medium Risk): All Hazards (Bushfire - General Risk): All Hazard (Bushfire - Urban Interface): All Hazards (Bushfire - Regional) : All

Class of Development	Applicable Policies			
	Zone	General Development Policies	Subzone (applies only in the area affected by the Subzone)	Overlay (applies only in the area affected by the Overlay)
		<p>Manoeuvrability]: PO 18.3, 18.4, 18.5</p> <p>Design in Rural Areas [Design of Transportable Dwellings]: PO 20.1</p> <p>Infrastructure and Renewable Energy Facilities [Water Supply]: PO 11.1</p> <p>Infrastructure and Renewable Energy Facilities [Wastewater Services]: PO 12.1, 12.2</p> <p>Interface Between Land Uses [Interface with Mines and Quarries (Rural and Remote Areas)]: PO 10.1</p> <p>Site Contamination: PO 1.1</p>		<p>Hazards (Flooding): All</p> <p>Historic Area: All</p> <p>Key Outback and Rural Routes: All</p> <p>Key Railway Crossings: All</p> <p>Limited Land Division: All</p> <p>Local Heritage Place: All</p> <p>Major Urban Transport Routes: All</p> <p>Marine Parks (Managed Use): All</p> <p>Mt Lofty Ranges Catchment (Area 1): All</p> <p>Mt Lofty Ranges Catchment (Area 2): All</p> <p>Murray Darling Basin: All</p> <p>Native Vegetation: All</p> <p>Noise and Air Emissions: All</p> <p>Non-stop Corridor: All</p> <p>Prescribed Water Resources Area: All</p> <p>Prescribed Watercourses: All</p> <p>Prescribed Wells Area: All</p> <p>Ramsar Wetlands: All</p> <p>River Murray Flood Plain: All</p> <p>River Murray Tributaries Area: All</p> <p>Significant Landscape Protection: All</p> <p>Sloping Land: All</p> <p>State Heritage Area: All</p> <p>State Heritage Place: All</p> <p>State Significant Native Vegetation: All</p> <p>Strategic Infrastructure (Gas Pipelines): All</p> <p>Traffic Generating Development: All</p> <p>Urban Transport Routes: All</p> <p>Water Protection Area: All</p> <p>Water Resources: All</p>
Dwelling addition	[Built Form and Character]: PO 2.4	<p>Clearance from Overhead Powerlines: PO 1.1</p> <p>Design in Rural Areas [All Development - On-site Waste Treatment Systems]: PO 6.1</p> <p>Design in Rural Areas [All Residential Development – External Appearance]: PO 10.1</p>	None	<p>Airport Building Heights (Aircraft Landing Area): All</p> <p>Airport Building Heights (Regulated): All</p> <p>Building Near Airfields: All</p> <p>Character Preservation District: All</p>

Class of Development	Applicable Policies			
	Zone	General Development Policies	Subzone (applies only in the area affected by the Subzone)	Overlay (applies only in the area affected by the Overlay)
				Coastal Areas: All Defence Aviation Area: All Resource Extraction Protection Area: All Hazards (Acid Sulfate Soils): All Hazards (Bushfire – High Risk): All Hazards (Bushfire - Medium Risk): All Hazards (Bushfire - General Risk): All Hazard (Bushfire - Urban Interface): All Hazards (Bushfire - Regional) : All Hazards (Flooding): All Historic Area: All Key Outback and Rural Routes: All Local Heritage Place: All Major Urban Transport Routes: All Marine Parks (Managed Use): All Mt Lofty Ranges Catchment (Area 1): All Mt Lofty Ranges Catchment (Area 2): All Native Vegetation: All Non-stop Corridor: All Ramsar Wetlands: All River Murray Flood Plain: All Significant Landscape Protection: All Sloping Land: All State Heritage Area: All State Heritage Place: All State Significant Native Vegetation: All Urban Transport Routes: All
Horse Keeping	[Land Use and Intensity]: PO 1.2, 1.3, 1.4 [Built Form and Character]: PO 2.3	Animal Keeping and Horse Keeping [Siting and Design]: PO 1.1, 1.2 Animal Keeping and Horse Keeping [Horse Keeping]: PO 2.2, 2.3, 2.4, 2.5 Animal Keeping and Horse Keeping [Wastes]: PO 4.1 Interface between Land Use [General Land Use Compatibility] PO 1.2	Animal Husbandry Subzone [Land Use and Intensity]: PO 1.1, 1.3, 1.4 Intensive Horse Establishments Zone [Land Use and Intensity] PO 1.1, 1.2	Coastal Areas: All Marine Parks (Managed Use): All Mt Lofty Ranges Catchment (Area 1): All Mt Lofty Ranges Catchment (Area 2): All Murray Darling Basin: All Prescribed Water Resources Area: All

Class of Development	Applicable Policies			
	Zone	General Development Policies	Subzone (applies only in the area affected by the Subzone)	Overlay (applies only in the area affected by the Overlay)
				<p>Prescribed Watercourses: All</p> <p>Prescribed Wells Area: All</p> <p>Ramsar Wetlands: All</p> <p>River Murray Flood Plain: All</p> <p>River Murray Tributaries Area: All</p> <p>Water Protection Area: All</p> <p>Water Resources: All</p>
Land Division	[Land Division] PO 3.1	<p>Land Division in Rural Areas [Design and Layout]: All</p> <p>Land Division in Rural Areas [Roads and Access]: 3.1, 3.6, 3.7, 3.8, 3.9</p> <p>Land Division in Rural Areas [Infrastructure]: 4.2, 4.3</p> <p>Land Division in Rural Areas [Minor Land Division (Under 20 Allotments) - Water Sensitive Design]: PO 7.1, 7.2</p>	None	<p>Character Preservation District Overlay</p> <p>Coastal Areas Overlay</p> <p>Environment and Food Production Area Overlay</p> <p>Resource Extraction Protection Area Overlay</p> <p>Hazards (Acid Sulfate Soils) Overlay</p> <p>Hazards (Bushfire – High Risk) Overlay</p> <p>Hazards (Bushfire - Medium Risk) Overlay</p> <p>Hazards (Bushfire - General Risk) Overlay</p> <p>Hazard (Bushfire - Urban Interface) Overlay</p> <p>Hazards (Bushfire - Regional) Overlay</p> <p>Hazards (Flooding) Overlay</p> <p>Key Outback and Rural Routes Overlay</p> <p>Key Railway Crossings Overlay</p> <p>Limited Land Division Overlay</p> <p>Local Heritage Place Overlay</p> <p>Major Urban Transport Routes Overlay</p> <p>Native Vegetation Overlay</p> <p>Non-stop Corridor Overlay</p> <p>Ramsar Wetlands Overlay</p> <p>Regulated Trees Overlay</p> <p>River Murray Flood Plain Overlay</p> <p>River Murray Tributaries Area Overlay</p> <p>State Heritage Area Overlay</p> <p>State Heritage Place Overlay</p> <p>State Significant Native Vegetation Overlay</p>

Class of Development	Applicable Policies			
	Zone	General Development Policies	Subzone (applies only in the area affected by the Subzone)	Overlay (applies only in the area affected by the Overlay)
				<p>Strategic Infrastructure (Gas Pipelines) Overlay</p> <p>Traffic Generating Development Overlay</p> <p>Urban Transport Routes Overlay</p>
Outbuilding (in the form of a garage)	[Built Form and Character]: PO 2.5	<p>Design in Rural Areas [All Residential Development – Ancillary Development]: PO 13.1</p> <p>Design in Rural Areas [Residential Development – 3 Building Levels or Less – External Appearance]: PO 14.1</p> <p>Design in Urban Areas [Residential Development – 3 Building Levels or Less – Car parking, Access and Manoeuvrability]: PO 18.1, 18.3, 18.4, 18.5</p> <p>Infrastructure and Renewable Energy Facilities [Wastewater Services]: PO 12.2</p> <p>Transport, Access and Parking [Vehicle Access]: PO 3.1, 3.5</p>	None	<p>Airport Building Heights (Aircraft Landing Area): All</p> <p>Airport Building Heights (Regulated): All</p> <p>Building Near Airfields: All</p> <p>Character Preservation District: All</p> <p>Coastal Areas: All</p> <p>Defence Aviation Area: All</p> <p>Hazards (Flooding): All</p> <p>Historic Area: All</p> <p>Key Outback and Rural Routes: All</p> <p>Local Heritage Place: All</p> <p>Major Urban Transport Routes: All</p> <p>Marine Parks (Managed Use): All</p> <p>Mt Lofty Ranges Catchment (Area 1): All</p> <p>Mt Lofty Ranges Catchment (Area 2): All</p> <p>Native Vegetation: All</p> <p>Non-stop Corridor: All</p> <p>Ramsar Wetlands: All</p> <p>River Murray Flood Plain: All</p> <p>River Murray Tributaries Area: All</p> <p>Significant Landscape Protection: All</p> <p>Sloping Land: All</p> <p>State Heritage Area: All</p> <p>State Heritage Place: All</p> <p>State Significant Native Vegetation: All</p> <p>Traffic Generating Development: All</p> <p>Urban Transport Routes: All</p>
Outbuilding (not being a garage)	[Built Form and Character]: PO 2.5	Design in Rural Areas [All Residential Development – Ancillary Development]: DTS 13.1, 13.2	None	<p>Airport Building Heights (Aircraft Landing Area): All</p> <p>Airport Building Heights (Regulated): All</p> <p>Building Near Airfields: All</p>

Class of Development	Applicable Policies			
	Zone	General Development Policies	Subzone (applies only in the area affected by the Subzone)	Overlay (applies only in the area affected by the Overlay)
		Infrastructure and Renewable Energy Facilities [Wastewater Services]: PO 12.2		Character Preservation District: All Coastal Areas: All Defence Aviation Area: All Hazards (Flooding): All Historic Area: All Key Outback and Rural Routes: All Local Heritage Place: All Major Urban Transport Routes: All Marine Parks (Managed Use): All Mt Lofty Ranges Catchment (Area 1): All Mt Lofty Ranges Catchment (Area 2): All Native Vegetation: All Non-stop Corridor: All Ramsar Wetlands: All River Murray Flood Plain: All River Murray Tributaries Area: All Significant Landscape Protection: All Sloping Land: All State Heritage Area: All State Heritage Place: All State Significant Native Vegetation: All Traffic Generating Development: All Urban Transport Routes: All
Shop	[Land Use and Intensity]: DTS 1.5 [Built Form and Character]: DTS 2.2	Clearance from Overhead Powerlines: DTS 1.1 Design in Rural Areas [On-site Waste Treatment Systems]: DTS 6.1 Design in Rural Areas [Car Parking Appearance]: DTS 7.4, 7.5 Interface Between Land Uses [Hours of Operation]: DTS 2.1 Interface Between Land Uses [Activities Generating Noise or Vibration]: DTS 4.1, 4.6 Interface Between Lands Uses [Air Quality]: PO 5.2 Infrastructure and Renewable Energy Facilities [Water Supply]: DTS 11.1	None	Airport Building Heights (Aircraft Landing Area): All Airport Building Heights (Regulated): All Building Near Airfields: All Character Preservation District: All Coastal Areas: All Defence Aviation Area: All Hazards (Acid Sulfate Soils): All Hazards (Bushfire – High Risk): All Hazards (Bushfire - Medium Risk): All Hazards (Bushfire - General Risk): All Hazard (Bushfire - Urban Interface): All

Class of Development	Applicable Policies			
	Zone	General Development Policies	Subzone (applies only in the area affected by the Subzone)	Overlay (applies only in the area affected by the Overlay)
		<p>Infrastructure and Renewable Energy Facilities [Wastewater Services]: DTS 12.1, 12.2</p> <p>Transport, Access and Parking [Movement Systems]: DTS 1.4</p> <p>Transport, Access and Parking [Vehicle Access]: DTS 3.1, 3.5</p> <p>Transport, Access and Parking [Vehicle Parking Rates]: DTS 5.1</p> <p>Transport, Access and Parking [Vehicle Parking Areas]: DTS 6.1, 6.6</p>		<p>Hazards (Bushfire - Regional) : All</p> <p>Hazards (Flooding): All</p> <p>Historic Area: All</p> <p>Key Outback and Rural Routes: All</p> <p>Key Railway Crossings: All</p> <p>Local Heritage Place: All</p> <p>Major Urban Transport Routes: All</p> <p>Marine Parks (Managed Use): All</p> <p>Mt Lofty Ranges Catchment (Area 1): All</p> <p>Mt Lofty Ranges Catchment (Area 2): All</p> <p>Murray Darling Basin: All</p> <p>Native Vegetation: All</p> <p>Non-stop Corridor: All</p> <p>Prescribed Water Resources Area: All</p> <p>Prescribed Watercourses: All</p> <p>Prescribed Wells Area: All</p> <p>Ramsar Wetlands: All</p> <p>River Murray Flood Plain: All</p> <p>River Murray Tributaries Area: All</p> <p>Significant Landscape Protection: All</p> <p>Sloping Land: All</p> <p>State Heritage Area: All</p> <p>State Heritage Place: All</p> <p>State Significant Native Vegetation: All</p> <p>Traffic Generating Development: All</p> <p>Urban Transport Routes: All</p> <p>Water Protection Area: All</p> <p>Water Resources: All</p>
Tree Damaging Activity	None	None	None	Regulated Trees: All
Verandah	[Built Form and Character]: DTS 2.6	<p>Design in Rural Areas [All Residential Development – Ancillary Development]: DTS 13.1, 13.2</p> <p>Infrastructure and Renewable Energy Facilities [Wastewater Services]: PO 12.2</p>	None	<p>Character Preservation District: All</p> <p>Coastal Areas: All</p> <p>Hazards (Flooding): All</p> <p>Historic Area: All</p> <p>Local Heritage Place: All</p> <p>Marine Parks (Managed Use): All</p> <p>Mt Lofty Ranges Catchment (Area 1): All</p>

Class of Development	Applicable Policies			
	Zone	General Development Policies	Subzone (applies only in the area affected by the Subzone)	Overlay (applies only in the area affected by the Overlay)
				Mt Lofty Ranges Catchment (Area 2): All Native Vegetation: All Ramsar Wetlands: All River Murray Flood Plain: All River Murray Tributaries Area: All Sloping Land: All State Heritage Area: All State Heritage Place: All State Significant Native Vegetation: All
All other Code Assessed Development	All	All	None	Any Relevant Overlay: All

Table 4 –Restricted Development Classification

Class of Development The following Classes of Development are classified as Restricted subject to any 'Exclusions'	Exclusions
Shop	Restaurant Shop with a gross leasable floor area less than 200m ²

Assessment Provisions

Desired Outcome (DO)

DO 1

A spacious, secluded and peaceful residential lifestyle within semi-rural or semi-natural environments, providing opportunities for a range of low-intensity rural activities and home based business activities that complement that lifestyle choice.

Performance Outcomes and Deemed to Satisfy / Designated Performance Outcome Criteria

Land Use and Intensity

PO 1.1

Residential development that:

- (a) is consistent with a private, peaceful and semi-rural or natural character; and
- (b) does not place additional demands on existing local services and infrastructure.

DTS/DPF 1.1

Not more than one dwelling per allotment.

PO 1.2

Animal keeping and horse keeping of a scale that is ancillary to and in association with the residential use of the land.

DTS/DPF 1.2

The keeping of animals:

- (a) is ancillary to a dwelling located on the same allotment;
- (b) takes place on an allotment with an area of at least 1ha; and
- (c) for horse keeping, is limited to not more than 2 horses per allotment.

PO 1.3

Horse keeping only undertaken if the horses are accommodated within a stable or shelter with supplementary feeding to maintain pasture cover

DTS/DPF 1.3

Horse keeping includes the provision of:

- (a) stabling or similar sheltering; and
- (b) a grazing area of at least 0.5ha.

PO 1.4

Non-residential development that complements the semi-rural or semi-natural residential character and amenity that:

- a. is ancillary to a dwelling erected on the same allotment;
- b. comprises small-scale commercial uses including offices, shops and consulting rooms;
- c. comprises small-scale light industrial uses; and
- d. avoids adverse interface conflicts with other land uses.

DTS/DPF 1.4

None are applicable.

PO 1.5

Shop, consulting rooms, offices and light industrial development of a scale that does not adversely impact the semi-rural or semi-natural residential character and amenity of a locality.

DTS/DPF 1.5

Total floor area does not exceed:

- (a) in relation to a shop, consulting room or office - 100m²
- (b) in relation to a light industry - 100m².

Built Form and Character

PO 2.1

Dwellings are sufficiently separated from site boundaries and of a scale that reinforces the semi-rural or semi-natural character and amenity.

DTS/DPF 2.1

Dwellings:

- (a) are setback from all allotment boundaries by at least 15m;
- (b) have a building height that is no greater than 2 building levels and 9 metres; and
- (c) have a wall height is no greater than 6 metres.

PO 2.2

Non-residential buildings designed and sited to minimise visual impact on the surrounding locality by:

- (a) having substantial setbacks from boundaries and adjacent public roads;
- (b) using low reflective materials and finishes that blend with the surrounding landscape; and
- (c) being located below ridgelines.

DTS/DPF 2.2

Buildings and structures:

- (a) do not exceed 100m² in total floor area;
- (b) are setback from all allotment boundaries by at least 25m;
- (c) if clad in sheet metal, is pre-colour treated or painted in a non-reflective colour;
- (d) have a building height that is no greater than 1 building level and 6 metres; and
- (e) have a wall height is no greater than 3 metres.

PO 2.3

Buildings, structures and associated facilities for the keeping of animals are sited, designed and of a scale and appearance that reinforces the semi-rural or semi-natural character and amenity.

DTS/DPF 2.3

Kennels, stables, shelters and associated yards:

- (a) are setback from all allotment boundaries by at least 25m;
- (b) have a building height that is no greater than 5m above natural ground level;
- (c) do not exceed 100m² in area; and
- (d) do not comprise more than 10% of the area of the allotment.

PO 2.4

Dwelling additions are sited, designed and of a scale that reinforce the semi-rural or semi-natural character and amenity.

DTS/DPF 2.4

Additions or alterations to an existing dwelling:

- (a) are setback behind the main façade of the existing dwelling;
- (b) have a building height that is no greater than 2 building levels and 9 metres; and
- (c) have a wall height no greater than 6 metres.

PO 2.5

Outbuildings are sited, designed and of a scale that reinforce the semi-rural or semi-natural character and amenity.

DTS/DPF 2.5

Outbuildings:

- (a) have a primary street setback that is at least as far back as the building to which it is ancillary;
- (b) have a total floor area that does not exceed 100m²;
- (c) have walls that do not exceed 4m in height measured from natural ground level and not including a gable end;
- (d) have a total roof height that does not exceed 5m;
- (e) if clad in sheet metal, are pre-colour treated or painted in a non-reflective colour; and
- (f) are limited to no more than 2 outbuildings on the same allotment.

PO 2.6

Carports and verandahs are sited, designed and of a scale that reinforce the semi-rural or semi-natural character and amenity.

DTS/DPF 2.6

Carports and verandahs have a:

- (a) primary street setback that is at least as far back as the building to which it is ancillary;
- (b) total floor area that does not exceed 80m²;
- (c) post height that does not exceed 3m measured from natural ground level and not including a gable end; and
- (d) total roof height that does not exceed 5m.

Land Division

PO 3.1

Allotments are a suitable size and dimension to:

- (a) contribute to the existing semi-rural settlement pattern; and
- (b) accommodate the intended use of the land.

DTS/DPF 3.1

Allotments have:

- (a) an area not less than that specified in the *Minimum Allotment Size Technical and Numeric Variation Overlay*; and
- (b) a frontage to a public road not less than 50m; or

in the case of a battleaxe allotment, a frontage to a public road not less than 6m and a maximum driveway 'handle' length of no more than 30m.

Suburban Employment Zone

Table 1 – Accepted Development Classification

Class of Development The following Classes of Development are classified as Accepted Development subject to meeting the 'Accepted Development Classification Criteria'	Accepted Development Classification Criteria
Building work on railway land	1 Building work is associated with a railway 2 It is situated (or to be situated) on railway land 3 It is required for the conduct or maintenance of railway activities.
Internal building work Except where any of the following apply: <ul style="list-style-type: none"> • A Local Heritage Place identified in the Local Heritage Place Overlay • State Heritage Area Overlay • A State Heritage Place identified in the State Heritage Place Overlay 	1 There will be no increase in the total floor area of the building 2 There will be no alteration to the external appearance of the building.
Shade sail Except where any of the following apply: <ul style="list-style-type: none"> • Character Preservation District Overlay • Coastal Areas Overlay • Character Area Overlay • Historic Area Overlay • Local Heritage Place Overlay • State Heritage Area Overlay • State Heritage Place Overlay • Native Vegetation Overlay • State Significant Native Vegetation Overlay • River Murray Flood Plain Overlay • Sloping Land Overlay • Water Resources Overlay 	8 The development will not be built, or encroach, on an area that is, or will be, required for a sewerage system or waste control system 9 Shade sail consists of permeable material 10 The total area of the sail - does not exceed 40m ² 11 No part of the shade sail will be: <ul style="list-style-type: none"> (a) 3m above ground or floor level (depending on where it is situated) at any place within 900mm of a boundary of the allotment (b) 5m above ground or floor level (depending on where it is situated) within any other part of the allotment 12 Primary street setback – at least as far back as the building line of the building to which it is ancillary 13 If any part of the sail will be situated on a boundary of the allotment, the length of sail along a boundary does not exceed 8m 14 In a case where any part of the sail or a supporting structure will be situated on a side boundary of the allotment – the length of the sail and any such supporting structure together with all relevant walls or structures located along the boundary will not exceed 45% of the length of the boundary.
Solar photovoltaic panels (roof mounted)	4 Panels are installed parallel to the roof of a building and with the underside surface of the panel not being more than 100mm above the surface of the roof

<p>Except where any of the following apply:</p> <ul style="list-style-type: none"> • Historic Area Overlay • A Local Heritage Place identified in the Local Heritage Place Overlay • State Heritage Area Overlay • A State Heritage Place identified in the State Heritage Place Overlay 	<p>5 Panels and associated components do not overhang any part of the roof</p> <p>6 Does not apply to system with a generating capacity of more than 5MW that is to be connected to the State's power system.</p>
<p>Water tank (above ground) Except where any of the following apply</p> <ul style="list-style-type: none"> • Character Preservation District Overlay • Coastal Areas Overlay • Hazards (Flooding) Overlay • Character Area Overlay • Historic Area Overlay • Local Heritage Place Overlay • State Heritage Area Overlay • State Heritage Place Overlay • Native Vegetation Overlay • State Significant Native Vegetation Overlay • River Murray Flood Plain Overlay • Sloping Land Overlay • Water Resources Overlay 	<p>8 The development will not be built, or encroach, on an area that is, or will be, required for a sewerage system or waste control system</p> <p>9 The tank is part of a roof drainage system</p> <p>10 Total floor area - not exceeding 15m²</p> <p>11 The tank is located wholly above ground</p> <p>12 Tank height – does not exceed 4m above natural ground level</p> <p>13 Primary street setback – at least as far back as the building line of the building to which it is ancillary</p> <p>14 In the case of a tank made of metal – the tank is pre-colour treated or painted in a non-reflective colour.</p>
<p>Water tank (underground) Except where any of the following apply:</p> <ul style="list-style-type: none"> • Character Preservation District Overlay • Coastal Areas Overlay • Native Vegetation Overlay • State Significant Native Vegetation Overlay • Sloping Land Overlay • Water Resources Overlay 	<p>3 The development will not be built, or encroach, on an area that is, or will be, required for a sewerage system or waste control system</p> <p>4 The tank (including any associated pump) is located wholly below the level of the ground.</p>

Table 2 – Deemed-to-Satisfy Development Classification

Class of Development The following Classes of Development are classified as Deemed-to-Satisfy Development subject to meeting the 'Deemed-to-Satisfy Development Classification Criteria'	Deemed-to-Satisfy Development Classification Criteria			
	Provisions referred to are Deemed-to-Satisfy Criteria Where a development comprises more than one Class of Development the relevant criteria will be taken to be the sum of the criteria for each Class of Development.			
	Zone	General Development Policies	Subzone (applies only in the area affected by the Subzone)	Overlay (applies only in the area affected by the Overlay)
<p>Advertisement</p> <p>Except where any of the following apply:</p> <ul style="list-style-type: none"> • Advertising Near Signalised Intersections Overlay • Character Area Overlay • Character Preservation District Overlay • Coastal Areas Overlay • Hazards (Bushfire - High Risk) Overlay • Hazards (Bushfire - Medium Risk) Overlay • Hazards (Bushfire - General Risk) Overlay • Hazards (Bushfire - Urban Interface) Overlay • Hazards (Bushfire - Regional) Overlay • Hazards (Flooding) Overlay • Historic Area Overlay • Local Heritage Place Overlay • Marine Parks (Managed Use) Overlay • Mt Lofty Ranges Catchment (Area 2) Overlay • Murray Darling Basin Overlay • Non-stop Corridor Overlay • Prescribed Water Resources Area Overlay • Prescribed Watercourses Overlay • Prescribed Wells Area Overlay • Regulated Trees Overlay • River Murray Flood Plain Overlay • River Murray Tributaries Area Overlay • Sloping Land Overlay • State Heritage Area Overlay • State Heritage Place Overlay • Water Protection Area Overlay • Water Resources Overlay 	[Advertisements]: DTS 6.1	<p>Advertisements [Appearance]: DTS 1.1, 1.3, 1.4</p> <p>Advertisements [Proliferation of Advertisements]: DTS 2.1, 2.2</p> <p>Advertisements [Advertising Content]: DTS 3.1</p> <p>Advertisements [Amenity Content]: DTS 4.1</p> <p>Advertising [Safety]: DTS 5.1, 5.2, 5.3, 5.4, 5.5</p> <p>Clearance from Overhead Powerlines: DTS 1.1</p>	None	<p>Airport Building Heights (Aircraft Landing Area): DTS 1.1</p> <p>Airport Building Heights (Regulated): DTS 1.1, 1.2</p> <p>Building Near Airfields: DTS 1.1, 1.2</p> <p>Defence Aviation Area: DTS 1.1, 1.3</p> <p>Future Road Widening: DTS 1.1</p> <p>Key Outback and Rural Routes: DTS 8.1, 10.1</p> <p>Key Railway Crossings: DTS 1.1</p> <p>Major Transport Routes: DTS 8.1, 10.1</p> <p>Native Vegetation: DTS 1.1, 1.2</p> <p>State Significant Native Vegetation: DTS 1.1</p> <p>Urban Transport Routes: DTS 8.1, 10.1</p>
Consulting room	[Land Use and	Design in Urban Areas [Car Parking Appearance]: DTS 6.4, 6.5	None	Airport Building Heights (Aircraft Landing Area): DTS 1.1

Class of Development The following Classes of Development are classified as Deemed-to-Satisfy Development subject to meeting the 'Deemed-to-Satisfy Development Classification Criteria'	Deemed-to-Satisfy Development Classification Criteria Provisions referred to are Deemed-to-Satisfy Criteria Where a development comprises more than one Class of Development the relevant criteria will be taken to be the sum of the criteria for each Class of Development.			
	Zone	General Development Policies	Subzone (applies only in the area affected by the Subzone)	Overlay (applies only in the area affected by the Overlay)
Except where any of the following apply: <ul style="list-style-type: none"> • Character Area Overlay • Character Preservation District Overlay • Coastal Areas Overlay • Concept Plans Technical and Numeric Variation Overlay • Hazards (Bushfire - General Risk) Overlay • Hazards (Bushfire - High Risk) Overlay • Hazards (Bushfire - Medium Risk) Overlay • Hazards (Bushfire - Regional) Overlay • Hazards (Flooding) Overlay • Historic Area Overlay • Local Heritage Place Overlay • Marine Parks (Managed Use) Overlay • Mt Lofty Ranges Catchment (Area 2) Overlay • Murray Darling Basin Overlay • Non-stop Corridor Overlay • Prescribed Water Resources Area Overlay • Prescribed Watercourses Overlay • Prescribed Wells Area Overlay • River Murray Flood Plain Overlay • River Murray Tributaries Area Overlay • Sloping Land Overlay • State Heritage Area Overlay • State Heritage Place Overlay • Strategic Infrastructure Gas Pipelines Overlay • Traffic Generating Development Overlay • Water Protection Area Overlay • Water Resources Overlay 	Intensity]: DTS 1.1 [Built Form and Character]: DTS 3.3, 3.4, 3.5 [Interface Height]: DTS 4.1, 4.2 [Landscaping]: DTS 5.1, 5.2	Interface Between Land Uses [Hours of Operation]: DTS 2.1 Interface Between Land Uses [Overshadowing]: DTS 3.1, 3.2 Infrastructure and Renewable Energy Facilities [Water Supply]: DTS 11.1 Infrastructure and Renewable Energy Facilities [Wastewater Services]: DTS 12.1, 12.2 Transport, Access and Parking [Movement Systems]: DTS 1.4 Transport, Access and Parking [Vehicle Access]: DTS 3.1, 3.5, 3.6 Transport, Access and Parking [Vehicle Parking Rates]: DTS 5.1	Airport Building Heights (Regulated): DTS 1.1, 1.2 Building Near Airfields: DTS 1.1, 1.2 Defence Aviation Area: DTS 1.1, 1.3 Future Road Widening: DTS 1.1 Key Outback and Rural Routes: All Key Railway Crossings: DTS 1.1 Major Transport Routes: All Native Vegetation: DTS 1.1, 1.2 State Significant Native Vegetation: DTS 1.1 Urban Transport Routes: DTS All	
Office Except where any of the following apply: <ul style="list-style-type: none"> • Character Area Overlay 	[Land Use and Intensity]: DTS 1.1 [Built Form and	Design in Urban Areas [Car Parking Appearance]: DTS 6.4, 6.5 Interface Between Land Uses [Hours of Operation]: DTS 2.1	None Airport Building Heights (Aircraft Landing Area): DTS 1.1 Airport Building Heights (Regulated): DTS 1.1, 1.2	

Class of Development The following Classes of Development are classified as Deemed-to-Satisfy Development subject to meeting the 'Deemed-to-Satisfy Development Classification Criteria'	Deemed-to-Satisfy Development Classification Criteria Provisions referred to are Deemed-to-Satisfy Criteria Where a development comprises more than one Class of Development the relevant criteria will be taken to be the sum of the criteria for each Class of Development.			
	Zone	General Development Policies	Subzone (applies only in the area affected by the Subzone)	Overlay (applies only in the area affected by the Overlay)
<ul style="list-style-type: none"> • Character Preservation District Overlay • Coastal Areas Overlay • Concept Plans Technical and Numeric Variation Overlay • Hazards (Bushfire - General Risk) Overlay • Hazards (Bushfire - High Risk) Overlay • Hazards (Bushfire - Medium Risk) Overlay • Hazards (Bushfire - Regional) Overlay • Hazards (Flooding) Overlay • Historic Area Overlay • Local Heritage Place Overlay • Marine Parks (Managed Use) Overlay • Mt Lofty Ranges Catchment (Area 2) Overlay • Murray Darling Basin Overlay • Non-stop Corridor Overlay • Prescribed Water Resources Area Overlay • Prescribed Watercourses Overlay • Prescribed Wells Area Overlay • River Murray Flood Plain Overlay • River Murray Tributaries Area Overlay • Sloping Land Overlay • State Heritage Area Overlay • State Heritage Place Overlay • Strategic Infrastructure Gas Pipelines Overlay • Traffic Generating Development Overlay • Water Protection Area Overlay • Water Resources Overlay 	Character]: DTS 3.3, 3.4, 3.5 [Interface Height]: DTS 4.1, 4.2 [Landscaping]: DTS 5.1, 5.2	Interface Between Land Uses [Overshadowing]: DTS 3.1, 3.2 Infrastructure and Renewable Energy Facilities [Water Supply]: DTS 11.1 Infrastructure and Renewable Energy Facilities [Wastewater Services]: DTS 12.1, 12.2 Transport, Access and Parking [Movement Systems]: DTS 1.4 Transport, Access and Parking [Vehicle Access]: DTS 3.1, 3.5, 3.6 Transport, Access and Parking [Vehicle Parking Rates]: DTS 5.1		Building Near Airfields: DTS 1.1, 1.2 Defence Aviation Area: DTS 1.1, 1.3 Future Road Widening: DTS 1.1 Key Outback and Rural Routes: All Key Railway Crossings: DTS 1.1 Major Transport Routes: All Native Vegetation: DTS 1.1, 1.2 State Significant Native Vegetation: DTS 1.1 Urban Transport Routes: DTS All

Table 3 – Applicable Policies for Performance Assessed Development

Class of Development	Applicable Policies			
	Zone	General Development Policies	Subzone	Overlay
	<p>The following policies are applicable to the assessment of the identified Class of Development.</p> <p>Policies referred to are Performance Outcome policies, and any associated Designated Performance Features. Relevant Desired Outcomes are not listed, but automatically apply in relation to a Performance Assessed Development.</p> <p>Where a development comprises more than one Class of Development the relevant policies will be taken to be the sum of the applicable policies for each Class of Development.</p>			
Advertisement	[Advertisements]: PO 6.1	Advertisements [Appearance]: PO 1.1, 1.3, 1.4 Advertisements [Proliferation of Advertisements]: PO 2.1, 2.2 Advertisements [Advertising Content]: PO 3.1 Advertisements [Amenity Content]: PO 4.1 Advertising [Safety]: PO 5.1, 5.2, 5.3, 5.4, 5.5 Clearance from Overhead Powerlines: PO 1.1	None	Airport Building Heights (Aircraft Landing Area): PO 1.1 Airport Building Heights (Regulated): PO 1.1, 1.2 Building Near Airfields: PO 1.1, 1.2 Defence Aviation Area: PO 1.1, 1.3 Character Area: All Character Preservation District: All Coastal Areas: All Future Road Widening: PO 1.1 Hazards (Bushfire - General Risk): All Hazards (Bushfire - High Risk): All Hazards (Bushfire - Medium Risk): All Hazards (Bushfire - Regional): All Hazards (Flooding): All Historic Area: All Key Outback and Rural Routes: All Key Railway Crossings: PO 1.1 Local Heritage Place: All Major Transport Routes: All Marine Parks (Managed Use): All Mt Lofty Ranges Catchment (Area 2): All Murray Darling Basin: All Native Vegetation: PO 1.1, 1.2 Non-stop Corridor: All Prescribed Water Resources Area: All Prescribed Watercourses: All Prescribed Wells Area: All River Murray Flood Plain: All River Murray Tributaries Area: All Sloping Land: All State Heritage Area: All

Class of Development	Applicable Policies			
	Zone	General Development Policies	Subzone (applies only in the area affected by the Subzone)	Overlay (applies only in the area affected by the Overlay)
				State Heritage Place: All Strategic Infrastructure Gas Pipelines: All State Significant Native Vegetation: PO 1.1 Traffic Generating Development: All Urban Transport Routes: PO All Water Protection Area: All Water Resources: All
Bulky goods outlet	[Land Use and Intensity]: PO 1.1, 1.2 [Built Form and Character]: PO 2.1, 2.2 [Building Height and Setbacks]: PO 3.1, 3.2, 3.3, 3.4, 3.5, 3.6 [Landscaping]: PO 5.1, 5.2 [Concept Plans]: PO 7.1	Clearance from Overhead Powerlines: PO 1.1 Design in Rural Areas [On-site Waste Treatment Systems]: PO 6.1 Design in Urban Areas [All development – External appearance]: PO 1.4, 1.5 Design in Urban Areas [All development – Water Sensitive Urban Design]: PO 5.1 Design in Urban Areas [Car Parking Appearance]: PO 6.2 Design in Urban Areas [All Non-Residential Development – Water Sensitive Design]: PO 42.1 Infrastructure and Renewable Energy Facilities [Water Supply]: PO 11.1 Infrastructure and Renewable Energy Facilities [Wastewater Services]: PO 12.1, 12.2 Interface Between Land Uses [General Land Use Compatibility]: PO 1.2 Interface Between Land Uses [Hours of Operation]: PO 2.1 Interface Between Land Uses [Activities Generating Noise or Vibration]: PO 4.2 Interface Between Land Uses [Light Spill]: PO 6.1, 6.2 Transport, Access and Parking [Movement Systems]: PO 1.1, 1.2, 1.3, 1.4 Transport, Access and Parking [Sightlines]: PO 2.1, 2.2	None	Airport Building Heights (Aircraft Landing Area): PO 1.1 Airport Building Heights (Regulated): PO 1.1, 1.2 Building Near Airfields: PO 1.1, 1.2 Character Area: All Character Preservation District: All Coastal Areas: All Defence Aviation Area: PO 1.1, 1.3 Future Road Widening: All Hazards (Bushfire - High Risk): All Hazards (Bushfire - Medium Risk): All Hazards (Bushfire - General Risk): All Hazards (Bushfire - Regional): All Hazards (Flooding): All Historic Area: All Key Outback and Rural Routes: All Key Railway Crossings: All Local Heritage Place: All Major Transport Routes: All Marine Parks (Managed Use): All Mt Lofty Ranges Catchment (Area 2): All Murray Darling Basin: All Native Vegetation: All

Class of Development	Applicable Policies			
	Zone	General Development Policies	Subzone (applies only in the area affected by the Subzone)	Overlay (applies only in the area affected by the Overlay)
		<p>Transport, Access and Parking [Vehicle Access]: PO 3.1, 3.3, 3.4, 3.5, 3.7, 3.8, 3.9</p> <p>Transport, Access and Parking [Vehicle Parking Rates]: PO 5.1</p> <p>Transport, Access and Parking [Vehicle Parking Areas]: PO 6.1, 6.2, 6.5, 6.6</p>		<p>Non-stop Corridor: All</p> <p>Prescribed Water Resources Area: All</p> <p>Prescribed Watercourses: All</p> <p>Prescribed Wells Area: All</p> <p>River Murray Flood Plain: All</p> <p>River Murray Tributaries Area: All</p> <p>Sloping Land: All</p> <p>State Heritage Area: All</p> <p>State Heritage Place: All</p> <p>State Significant Native Vegetation: All</p> <p>Strategic Infrastructure Gas Pipelines: All</p> <p>Traffic Generating Development: All</p> <p>Urban Transport Routes: All</p> <p>Water Protection Area: All</p> <p>Water Resources: All</p>
Community centre	<p>[Land Use and Intensity]: PO 1.1, 1.2</p> <p>[Built Form and Character]: PO 2.1, 2.2</p> <p>[Building Height and Setbacks]: PO 3.1, 3.2, 3.3, 3.4, 3.5, 3.6</p> <p>[Landscaping]: PO 5.1, 5.2</p> <p>[Concept Plans]: PO 7.1</p>	<p>Clearance from Overhead Powerlines: PO 1.1</p> <p>Design in Rural Areas [On-site Waste Treatment Systems]: PO 6.1</p> <p>Design in Urban Areas [All development – External appearance]: PO 1.4, 1.5</p> <p>Design in Urban Areas [All development – Water Sensitive Urban Design]: PO 5.1</p> <p>Design in Urban Areas [Car Parking Appearance]: PO 6.2</p> <p>Design in Urban Areas [All Non-Residential Development – Water Sensitive Design]: PO 42.1</p> <p>Infrastructure and Renewable Energy Facilities [Water Supply]: PO 11.1</p> <p>Infrastructure and Renewable Energy Facilities [Wastewater Services]: PO 12.1, 12.2</p> <p>Interface Between Land Uses [General Land Use Compatibility]: PO 1.2</p> <p>Interface Between Land Uses [Hours of Operation]: PO 2.1</p>	None	<p>Airport Building Heights (Aircraft Landing Area): PO 1.1</p> <p>Airport Building Heights (Regulated): PO 1.1, 1.2</p> <p>Building Near Airfields: PO 1.1, 1.2</p> <p>Character Area: All</p> <p>Character Preservation District: All</p> <p>Coastal Areas: All</p> <p>Defence Aviation Area: PO 1.1, 1.3</p> <p>Future Road Widening: All</p> <p>Hazards (Bushfire - High Risk): All</p> <p>Hazards (Bushfire - Medium Risk): All</p> <p>Hazards (Bushfire - General Risk): All</p> <p>Hazards (Bushfire - Regional): All</p> <p>Hazards (Flooding): All</p> <p>Historic Area: All</p>

Class of Development	Applicable Policies			
	Zone	General Development Policies	Subzone (applies only in the area affected by the Subzone)	Overlay (applies only in the area affected by the Overlay)
		<p>Interface Between Land Uses [Activities Generating Noise or Vibration]: PO 4.2</p> <p>Interface Between Land Uses [Light Spill]: PO 6.1, 6.2</p> <p>Transport, Access and Parking [Movement Systems]: PO 1.1, 1.2, 1.3, 1.4</p> <p>Transport, Access and Parking [Sightlines]: PO 2.1, 2.2</p> <p>Transport, Access and Parking [Vehicle Access]: PO 3.1, 3.3, 3.4, 3.5, 3.7, 3.8, 3.9</p> <p>Transport, Access and Parking [Vehicle Parking Rates]: PO 5.1</p> <p>Transport, Access and Parking [Vehicle Parking Areas]: PO 6.1, 6.2, 6.5, 6.6</p>		<p>Key Outback and Rural Routes: All</p> <p>Key Railway Crossings: All</p> <p>Local Heritage Place: All</p> <p>Major Transport Routes: All</p> <p>Marine Parks (Managed Use): All</p> <p>Mt Lofty Ranges Catchment (Area 2): All</p> <p>Murray Darling Basin: All</p> <p>Native Vegetation: All</p> <p>Non-stop Corridor: All</p> <p>Prescribed Water Resources Area: All</p> <p>Prescribed Watercourses: All</p> <p>Prescribed Wells Area: All</p> <p>River Murray Flood Plain: All</p> <p>River Murray Tributaries Area: All</p> <p>Sloping Land: All</p> <p>State Heritage Area: All</p> <p>State Heritage Place: All</p> <p>State Significant Native Vegetation: All</p> <p>Strategic Infrastructure Gas Pipelines: All</p> <p>Traffic Generating Development: All</p> <p>Urban Transport Routes: All</p> <p>Water Protection Area: All</p> <p>Water Resources: All</p>
Consulting room Office	<p>[Land Use and Intensity]: PO 1.1, 1.2</p> <p>[Built Form and Character]: PO 2.1, 2.2</p> <p>[Building Height and Setbacks]: PO 3.1, 3.2, 3.3, 3.4, 3.5, 3.6</p> <p>[Landscaping]: PO 5.1, 5.2</p> <p>[Concept Plans]: PO 7.1</p>	<p>Clearance from Overhead Powerlines: PO 1.1</p> <p>Design in Rural Areas [On-site Waste Treatment Systems]: PO 6.1</p> <p>Design in Urban Areas [All development – External appearance]: PO 1.4, 1.5</p> <p>Design in Urban Areas [All development – Water Sensitive Urban Design]: PO 5.1</p> <p>Design in Urban Areas [Car Parking Appearance]: PO 6.2</p>	None	<p>Airport Building Heights (Aircraft Landing Area): PO 1.1</p> <p>Airport Building Heights (Regulated): PO 1.1, 1.2</p> <p>Building Near Airfields: PO 1.1, 1.2</p> <p>Character Area: All</p> <p>Character Preservation District: All</p> <p>Coastal Areas: All</p> <p>Defence Aviation Area: PO 1.1, 1.3</p>

Class of Development	Applicable Policies			
	Zone	General Development Policies	Subzone (applies only in the area affected by the Subzone)	Overlay (applies only in the area affected by the Overlay)
		<p>The following policies are applicable to the assessment of the identified Class of Development.</p> <p>Policies referred to are Performance Outcome policies, and any associated Designated Performance Features. Relevant Desired Outcomes are not listed, but automatically apply in relation to a Performance Assessed Development.</p> <p>Where a development comprises more than one Class of Development the relevant policies will be taken to be the sum of the applicable policies for each Class of Development.</p>		
		<p>Design in Urban Areas [All Non-Residential Development – Water Sensitive Design]: PO 42.1</p> <p>Infrastructure and Renewable Energy Facilities [Water Supply]: PO 11.1</p> <p>Infrastructure and Renewable Energy Facilities [Wastewater Services]: PO 12.1, 12.2</p> <p>Interface Between Land Uses [General Land Use Compatibility]: PO 1.2</p> <p>Interface Between Land Uses [Hours of Operation]: PO 2.1</p> <p>Interface Between Land Uses [Activities Generating Noise or Vibration]: PO 4.2</p> <p>Interface Between Land Uses [Light Spill]: PO 6.1, 6.2</p> <p>Transport, Access and Parking [Movement Systems]: PO 1.1, 1.2, 1.3, 1.4</p> <p>Transport, Access and Parking [Sightlines]: PO 2.1, 2.2</p> <p>Transport, Access and Parking [Vehicle Access]: PO 3.1, 3.3, 3.4, 3.5, 3.7, 3.8, 3.9</p> <p>Transport, Access and Parking [Vehicle Parking Rates]: PO 5.1</p> <p>Transport, Access and Parking [Vehicle Parking Areas]: PO 6.1, 6.2, 6.5, 6.6</p>		<p>Future Road Widening: All</p> <p>Hazards (Bushfire - High Risk): All</p> <p>Hazards (Bushfire - Medium Risk): All</p> <p>Hazards (Bushfire - General Risk): All</p> <p>Hazards (Bushfire - Regional): All</p> <p>Hazards (Flooding): All</p> <p>Historic Area: All</p> <p>Key Outback and Rural Routes: All</p> <p>Key Railway Crossings: All</p> <p>Local Heritage Place: All</p> <p>Major Transport Routes: All</p> <p>Marine Parks (Managed Use): All</p> <p>Mt Lofty Ranges Catchment (Area 2): All</p> <p>Murray Darling Basin: All</p> <p>Native Vegetation: All</p> <p>Non-stop Corridor: All</p> <p>Prescribed Water Resources Area: All</p> <p>Prescribed Watercourses: All</p> <p>Prescribed Wells Area: All</p> <p>River Murray Flood Plain: All</p> <p>River Murray Tributaries Area: All</p> <p>Sloping Land: All</p> <p>State Heritage Area: All</p> <p>State Heritage Place: All</p> <p>State Significant Native Vegetation: All</p> <p>Strategic Infrastructure Gas Pipelines: All</p> <p>Traffic Generating Development: All</p> <p>Urban Transport Routes: All</p> <p>Water Protection Area: All</p> <p>Water Resources: All</p>

Class of Development	Applicable Policies			
	Zone	General Development Policies	Subzone (applies only in the area affected by the Subzone)	Overlay (applies only in the area affected by the Overlay)
	<p>The following policies are applicable to the assessment of the identified Class of Development.</p> <p>Policies referred to are Performance Outcome policies, and any associated Designated Performance Features. Relevant Desired Outcomes are not listed, but automatically apply in relation to a Performance Assessed Development.</p> <p>Where a development comprises more than one Class of Development the relevant policies will be taken to be the sum of the applicable policies for each Class of Development.</p>			
Demolition of a State or Local Heritage Place	None	None	None	Local Heritage Place: All State Heritage Place: All
Demolition within an Historic Area Overlay or State Heritage Area Overlay	None	None	None	Historic Area: All State Heritage Area: All
Hotel	[Land Use and Intensity]: PO 1.1	Clearance from Overhead Powerlines: PO 1.1 Design in Urban Areas [External Appearance]: PO 1.4 Design in Urban Areas [Car Parking Appearance]: PO 6.1, 6.4, 6.5 Design in Urban Areas [Water Sensitive Design]: PO 42.1, 42.3 Interface Between Land Uses [Hours of Operation]: PO 2.1 Interface Between Land Uses [Overshadowing]: PO 3.1, 3.2 Interface Between Land Uses [Activities Generating Noise or Vibration]: PO 4.1, 4.2, 4.5, 4.6 Interface Between Lands Uses [Air Quality]: PO 5.2 Interface Between Land Uses [Light Spill]: PO 6.1, 6.2 Infrastructure and Renewable Energy Facilities [Water Supply]: PO 11.1 Infrastructure and Renewable Energy Facilities [Wastewater Services]: PO 12.1, 12.2 Tourism Development: PO 1.1, 1.2 Transport, Access and Parking [Movement Systems]: All Transport, Access and Parking [Sightlines]: All Transport, Access and Parking [Vehicle Access]: PO All Transport, Access and Parking [Vehicle Parking Rates]: PO 5.1 Transport, Access and Parking [Vehicle Parking Areas]: PO 6.1, 6.2, 6.5, 6.6	None	Airport Building Heights (Aircraft Landing Area): PO 1.1 Airport Building Heights (Regulated): PO 1.1, 1.2 Building Near Airfields: PO 1.1, 1.2 Character Area: All Character Preservation District: All Coastal Areas: All Defence Aviation Area: PO 1.1, 1.3 Future Road Widening: All Hazards (Bushfire - High Risk): All Hazards (Bushfire - Medium Risk): All Hazards (Bushfire - General Risk): All Hazards (Bushfire - Regional): All Hazards (Flooding): All Historic Area: All Key Outback and Rural Routes: All Key Railway Crossings: All Local Heritage Place: All Major Transport Routes: All Marine Parks (Managed Use): All Mt Lofty Ranges Catchment (Area 2): All Murray Darling Basin: All Native Vegetation: All Non-stop Corridor: All Prescribed Water Resources Area: All Prescribed Watercourses: All Prescribed Wells Area: All

Class of Development	Applicable Policies			
	Zone	General Development Policies	Subzone (applies only in the area affected by the Subzone)	Overlay (applies only in the area affected by the Overlay)
				<p>River Murray Flood Plain: All</p> <p>River Murray Tributaries Area: All</p> <p>Sloping Land: All</p> <p>State Heritage Area: All</p> <p>State Heritage Place: All</p> <p>State Significant Native Vegetation: All</p> <p>Strategic Infrastructure Gas Pipelines: All</p> <p>Traffic Generating Development: All</p> <p>Urban Transport Routes: All</p> <p>Water Protection Area: All</p> <p>Water Resources: All</p>
Light industry	<p>[Land Use and Intensity]: PO 1.1, 1.2</p> <p>[Built Form and Character]: PO 2.1, 2.2</p> <p>[Building Height and Setbacks]: PO 3.1, 3.2, 3.3, 3.4, 3.5, 3.6</p> <p>[Landscaping]: PO 5.1, 5.2</p> <p>[Concept Plans]: PO 7.1</p>	<p>Clearance from Overhead Powerlines: PO 1.1</p> <p>Design in Rural Areas [On-site Waste Treatment Systems]: PO 6.1</p> <p>Design in Urban Areas [All development – External appearance]: PO 1.4, 1.5</p> <p>Design in Urban Areas [All development – Water Sensitive Urban Design]: PO 5.1</p> <p>Design in Urban Areas [Car Parking Appearance]: PO 6.2</p> <p>Design in Urban Areas [All Non-Residential Development – Water Sensitive Design]: PO 42.1</p> <p>Infrastructure and Renewable Energy Facilities [Water Supply]: PO 11.1</p> <p>Infrastructure and Renewable Energy Facilities [Wastewater Services]: PO 12.1, 12.2</p> <p>Interface Between Land Uses [General Land Use Compatibility]: PO 1.2</p> <p>Interface Between Land Uses [Hours of Operation]: PO 2.1</p> <p>Interface Between Land Uses [Activities Generating Noise or Vibration]: PO 4.2</p> <p>Interface Between Land Uses [Light Spill]: PO 6.1, 6.2</p>	None	<p>Airport Building Heights (Aircraft Landing Area): PO 1.1</p> <p>Airport Building Heights (Regulated): PO 1.1, 1.2</p> <p>Building Near Airfields: PO 1.1, 1.2</p> <p>Character Area: All</p> <p>Character Preservation District: All</p> <p>Coastal Areas: All</p> <p>Defence Aviation Area: PO 1.1, 1.3</p> <p>Future Road Widening: All</p> <p>Hazards (Bushfire - High Risk): All</p> <p>Hazards (Bushfire - Medium Risk): All</p> <p>Hazards (Bushfire - General Risk): All</p> <p>Hazards (Bushfire - Regional): All</p> <p>Hazards (Flooding): All</p> <p>Historic Area: All</p> <p>Key Outback and Rural Routes: All</p> <p>Key Railway Crossings: All</p> <p>Local Heritage Place: All</p> <p>Major Transport Routes: All</p>

Class of Development	Applicable Policies			
	Zone	General Development Policies	Subzone (applies only in the area affected by the Subzone)	Overlay (applies only in the area affected by the Overlay)
		<p>Transport, Access and Parking [Movement Systems]: PO 1.1, 1.2, 1.3, 1.4</p> <p>Transport, Access and Parking [Sightlines]: PO 2.1, 2.2</p> <p>Transport, Access and Parking [Vehicle Access]: PO 3.1, 3.3, 3.4, 3.5, 3.7, 3.8, 3.9</p> <p>Transport, Access and Parking [Vehicle Parking Rates]: PO 5.1</p> <p>Transport, Access and Parking [Vehicle Parking Areas]: PO 6.1, 6.2, 6.5, 6.6</p>		<p>Marine Parks (Managed Use): All</p> <p>Mt Lofty Ranges Catchment (Area 2): All</p> <p>Murray Darling Basin: All</p> <p>Native Vegetation: All</p> <p>Non-stop Corridor: All</p> <p>Prescribed Water Resources Area: All</p> <p>Prescribed Watercourses: All</p> <p>Prescribed Wells Area: All</p> <p>River Murray Flood Plain: All</p> <p>River Murray Tributaries Area: All</p> <p>Sloping Land: All</p> <p>State Heritage Area: All</p> <p>State Heritage Place: All</p> <p>State Significant Native Vegetation: All</p> <p>Strategic Infrastructure Gas Pipelines: All</p> <p>Traffic Generating Development: All</p> <p>Urban Transport Routes: All</p> <p>Water Protection Area: All</p> <p>Water Resources: All</p>
Motor repair station	<p>[Land Use and Intensity]: PO 1.1, 1.2</p> <p>[Built Form and Character]: PO 2.1, 2.2</p> <p>[Building Height and Setbacks]: PO 3.1, 3.2, 3.3, 3.4, 3.5, 3.6</p> <p>[Landscaping]: PO 5.1, 5.2</p> <p>[Concept Plans]: PO 7.1</p>	<p>Clearance from Overhead Powerlines: PO 1.1</p> <p>Design in Rural Areas [On-site Waste Treatment Systems]: PO 6.1</p> <p>Design in Urban Areas [All development – External appearance]: PO 1.4, 1.5</p> <p>Design in Urban Areas [All development – Water Sensitive Urban Design]: PO 5.1</p> <p>Design in Urban Areas [Car Parking Appearance]: PO 6.2</p> <p>Design in Urban Areas [All Non-Residential Development – Water Sensitive Design]: PO 42.1</p> <p>Infrastructure and Renewable Energy Facilities [Water Supply]: PO 11.1</p>	None	<p>Airport Building Heights (Aircraft Landing Area): PO 1.1</p> <p>Airport Building Heights (Regulated): PO 1.1, 1.2</p> <p>Building Near Airfields: PO 1.1, 1.2</p> <p>Character Area: All</p> <p>Character Preservation District: All</p> <p>Coastal Areas: All</p> <p>Defence Aviation Area: PO 1.1, 1.3</p> <p>Future Road Widening: All</p> <p>Hazards (Bushfire - High Risk): All</p> <p>Hazards (Bushfire - Medium Risk): All</p>

Class of Development	Applicable Policies			
	Zone	General Development Policies	Subzone (applies only in the area affected by the Subzone)	Overlay (applies only in the area affected by the Overlay)
		<p>Infrastructure and Renewable Energy Facilities [Wastewater Services]: PO 12.1, 12.2</p> <p>Interface Between Land Uses [General Land Use Compatibility]: PO 1.2</p> <p>Interface Between Land Uses [Hours of Operation]: PO 2.1</p> <p>Interface Between Land Uses [Activities Generating Noise or Vibration]: PO 4.2</p> <p>Interface Between Land Uses [Light Spill]: PO 6.1, 6.2</p> <p>Transport, Access and Parking [Movement Systems]: PO 1.1, 1.2, 1.3, 1.4</p> <p>Transport, Access and Parking [Sightlines]: PO 2.1, 2.2</p> <p>Transport, Access and Parking [Vehicle Access]: PO 3.1, 3.3, 3.4, 3.5, 3.7, 3.8, 3.9</p> <p>Transport, Access and Parking [Vehicle Parking Rates]: PO 5.1</p> <p>Transport, Access and Parking [Vehicle Parking Areas]: PO 6.1, 6.2, 6.5, 6.6</p>		<p>Hazards (Bushfire - General Risk): All</p> <p>Hazards (Bushfire - Regional): All</p> <p>Hazards (Flooding): All</p> <p>Historic Area: All</p> <p>Key Outback and Rural Routes: All</p> <p>Key Railway Crossings: All</p> <p>Local Heritage Place: All</p> <p>Major Transport Routes: All</p> <p>Marine Parks (Managed Use): All</p> <p>Mt Lofty Ranges Catchment (Area 2): All</p> <p>Murray Darling Basin: All</p> <p>Native Vegetation: All</p> <p>Non-stop Corridor: All</p> <p>Prescribed Water Resources Area: All</p> <p>Prescribed Watercourses: All</p> <p>Prescribed Wells Area: All</p> <p>River Murray Flood Plain: All</p> <p>River Murray Tributaries Area: All</p> <p>Sloping Land: All</p> <p>State Heritage Area: All</p> <p>State Heritage Place: All</p> <p>State Significant Native Vegetation: All</p> <p>Strategic Infrastructure Gas Pipelines: All</p> <p>Traffic Generating Development: All</p> <p>Urban Transport Routes: All</p> <p>Water Protection Area: All</p> <p>Water Resources: All</p>
Retail Fuel Outlet	<p>[Land Use and Intensity]: PO 1.1, 1.2</p> <p>[Built Form and Character]: PO 2.1, 2.2</p>	<p>Clearance from Overhead Powerlines: PO 1.1</p> <p>Design in Rural Areas [On-site Waste Treatment Systems]: PO 6.1</p> <p>Design in Urban Areas [All development – External appearance]: PO 1.4, 1.5</p>	None	<p>Airport Building Heights (Aircraft Landing Area): PO 1.1</p> <p>Airport Building Heights (Regulated): PO 1.1, 1.2</p> <p>Building Near Airfields: PO 1.1, 1.2</p>

Class of Development	Applicable Policies			
	Zone	General Development Policies	Subzone (applies only in the area affected by the Subzone)	Overlay (applies only in the area affected by the Overlay)
	<p>The following policies are applicable to the assessment of the identified Class of Development.</p> <p>Policies referred to are Performance Outcome policies, and any associated Designated Performance Features. Relevant Desired Outcomes are not listed, but automatically apply in relation to a Performance Assessed Development.</p> <p>Where a development comprises more than one Class of Development the relevant policies will be taken to be the sum of the applicable policies for each Class of Development.</p>			
	<p>[Building Height and Setbacks]: PO 3.1, 3.2, 3.3, 3.4, 3.5, 3.6</p> <p>[Landscaping]: PO 5.1, 5.2</p> <p>[Concept Plans]: PO 7.1</p>	<p>Design in Urban Areas [All development – Water Sensitive Urban Design]: PO 5.1</p> <p>Design in Urban Areas [Car Parking Appearance]: PO 6.2</p> <p>Design in Urban Areas [All Non-Residential Development – Water Sensitive Design]: PO 42.1</p> <p>Infrastructure and Renewable Energy Facilities [Water Supply]: PO 11.1</p> <p>Infrastructure and Renewable Energy Facilities [Wastewater Services]: PO 12.1, 12.2</p> <p>Interface Between Land Uses [General Land Use Compatibility]: PO 1.2</p> <p>Interface Between Land Uses [Hours of Operation]: PO 2.1</p> <p>Interface Between Land Uses [Activities Generating Noise or Vibration]: PO 4.2</p> <p>Interface Between Land Uses [Light Spill]: PO 6.1, 6.2</p> <p>Transport, Access and Parking [Movement Systems]: PO 1.1, 1.2, 1.3, 1.4</p> <p>Transport, Access and Parking [Sightlines]: PO 2.1, 2.2</p> <p>Transport, Access and Parking [Vehicle Access]: PO 3.1, 3.3, 3.4, 3.5, 3.7, 3.8, 3.9</p> <p>Transport, Access and Parking [Vehicle Parking Rates]: PO 5.1</p> <p>Transport, Access and Parking [Vehicle Parking Areas]: PO 6.1, 6.2, 6.5, 6.6</p>		<p>Character Area: All</p> <p>Character Preservation District: All</p> <p>Coastal Areas: All</p> <p>Defence Aviation Area: PO 1.1, 1.3</p> <p>Future Road Widening: All</p> <p>Hazards (Bushfire - High Risk): All</p> <p>Hazards (Bushfire - Medium Risk): All</p> <p>Hazards (Bushfire - General Risk): All</p> <p>Hazards (Bushfire - Regional): All</p> <p>Hazards (Flooding): All</p> <p>Historic Area: All</p> <p>Key Outback and Rural Routes: All</p> <p>Key Railway Crossings: All</p> <p>Local Heritage Place: All</p> <p>Major Transport Routes: All</p> <p>Marine Parks (Managed Use): All</p> <p>Mt Lofty Ranges Catchment (Area 2): All</p> <p>Murray Darling Basin: All</p> <p>Native Vegetation: All</p> <p>Non-stop Corridor: All</p> <p>Prescribed Water Resources Area: All</p> <p>Prescribed Watercourses: All</p> <p>Prescribed Wells Area: All</p> <p>River Murray Flood Plain: All</p> <p>River Murray Tributaries Area: All</p> <p>Sloping Land: All</p> <p>State Heritage Area: All</p> <p>State Heritage Place: All</p> <p>State Significant Native Vegetation: All</p> <p>Strategic Infrastructure Gas Pipelines: All</p> <p>Traffic Generating Development: All</p>

Class of Development	Applicable Policies			
	Zone	General Development Policies	Subzone (applies only in the area affected by the Subzone)	Overlay (applies only in the area affected by the Overlay)
				Urban Transport Routes: All Water Protection Area: All Water Resources: All
Service trade premises	[Land Use and Intensity]: PO 1.1, 1.2 [Built Form and Character]: PO 2.1, 2.2 [Building Height and Setbacks]: PO 3.1, 3.2, 3.3, 3.4, 3.5, 3.6 [Landscaping]: PO 5.1, 5.2 [Concept Plans]: PO 7.1	Clearance from Overhead Powerlines: PO 1.1 Design in Rural Areas [On-site Waste Treatment Systems]: PO 6.1 Design in Urban Areas [All development – External appearance]: PO 1.4, 1.5 Design in Urban Areas [All development – Water Sensitive Urban Design]: PO 5.1 Design in Urban Areas [Car Parking Appearance]: PO 6.2 Design in Urban Areas [All Non-Residential Development – Water Sensitive Design]: PO 42.1 Infrastructure and Renewable Energy Facilities [Water Supply]: PO 11.1 Infrastructure and Renewable Energy Facilities [Wastewater Services]: PO 12.1, 12.2 Interface Between Land Uses [General Land Use Compatibility]: PO 1.2 Interface Between Land Uses [Hours of Operation]: PO 2.1 Interface Between Land Uses [Activities Generating Noise or Vibration]: PO 4.2 Interface Between Land Uses [Light Spill]: PO 6.1, 6.2 Transport, Access and Parking [Movement Systems]: PO 1.1, 1.2, 1.3, 1.4 Transport, Access and Parking [Sightlines]: PO 2.1, 2.2 Transport, Access and Parking [Vehicle Access]: PO 3.1, 3.3, 3.4, 3.5, 3.7, 3.8, 3.9 Transport, Access and Parking [Vehicle Parking Rates]: PO 5.1 Transport, Access and Parking [Vehicle Parking Areas]: PO 6.1, 6.2, 6.5, 6.6	None	Airport Building Heights (Aircraft Landing Area): PO 1.1 Airport Building Heights (Regulated): PO 1.1, 1.2 Building Near Airfields: PO 1.1, 1.2 Character Area: All Character Preservation District: All Coastal Areas: All Defence Aviation Area: PO 1.1, 1.3 Future Road Widening: All Hazards (Bushfire - High Risk): All Hazards (Bushfire - Medium Risk): All Hazards (Bushfire - General Risk): All Hazards (Bushfire - Regional): All Hazards (Flooding): All Historic Area: All Key Outback and Rural Routes: All Key Railway Crossings: All Local Heritage Place: All Major Transport Routes: All Marine Parks (Managed Use): All Mt Lofty Ranges Catchment (Area 2): All Murray Darling Basin: All Native Vegetation: All Non-stop Corridor: All Prescribed Water Resources Area: All Prescribed Watercourses: All Prescribed Wells Area: All River Murray Flood Plain: All

Class of Development	Applicable Policies			
	Zone	General Development Policies	Subzone (applies only in the area affected by the Subzone)	Overlay (applies only in the area affected by the Overlay)
				<p>River Murray Tributaries Area: All</p> <p>Sloping Land: All</p> <p>State Heritage Area: All</p> <p>State Heritage Place: All</p> <p>State Significant Native Vegetation: All</p> <p>Strategic Infrastructure Gas Pipelines: All</p> <p>Traffic Generating Development: All</p> <p>Urban Transport Routes: All</p> <p>Water Protection Area: All</p> <p>Water Resources: All</p>
<p>Shop</p> <p>Except where any of the following apply:</p> <ul style="list-style-type: none"> The gross leasable floor area is more than 1000m² other than a bulky goods outlet or it is ancillary to a light industry 	<p>[Land Use and Intensity]: PO 1.1, 1.2</p> <p>[Built Form and Character]: PO 2.1, 2.2</p> <p>[Building Height and Setbacks]: PO 3.1, 3.2, 3.3, 3.4, 3.5, 3.6</p> <p>[Landscaping]: PO 5.1, 5.2</p> <p>[Concept Plans]: PO 7.1</p>	<p>Clearance from Overhead Powerlines: PO 1.1</p> <p>Design in Rural Areas [On-site Waste Treatment Systems]: PO 6.1</p> <p>Design in Urban Areas [All development – External appearance]: PO 1.4, 1.5</p> <p>Design in Urban Areas [All development – Water Sensitive Urban Design]: PO 5.1</p> <p>Design in Urban Areas [Car Parking Appearance]: PO 6.2</p> <p>Design in Urban Areas [All Non-Residential Development – Water Sensitive Design]: PO 42.1</p> <p>Infrastructure and Renewable Energy Facilities [Water Supply]: PO 11.1</p> <p>Infrastructure and Renewable Energy Facilities [Wastewater Services]: PO 12.1, 12.2</p> <p>Interface Between Land Uses [General Land Use Compatibility]: PO 1.2</p> <p>Interface Between Land Uses [Hours of Operation]: PO 2.1</p> <p>Interface Between Land Uses [Activities Generating Noise or Vibration]: PO 4.2</p> <p>Interface Between Land Uses [Light Spill]: PO 6.1, 6.2</p>	None	<p>Airport Building Heights (Aircraft Landing Area): PO 1.1</p> <p>Airport Building Heights (Regulated): PO 1.1, 1.2</p> <p>Building Near Airfields: PO 1.1, 1.2</p> <p>Character Area: All</p> <p>Character Preservation District: All</p> <p>Coastal Areas: All</p> <p>Defence Aviation Area: PO 1.1, 1.3</p> <p>Future Road Widening: All</p> <p>Hazards (Bushfire - High Risk): All</p> <p>Hazards (Bushfire - Medium Risk): All</p> <p>Hazards (Bushfire - General Risk): All</p> <p>Hazards (Bushfire - Regional): All</p> <p>Hazards (Flooding): All</p> <p>Historic Area: All</p> <p>Key Outback and Rural Routes: All</p> <p>Key Railway Crossings: All</p> <p>Local Heritage Place: All</p> <p>Major Transport Routes: All</p> <p>Marine Parks (Managed Use): All</p>

Class of Development	Applicable Policies			
	Zone	General Development Policies	Subzone (applies only in the area affected by the Subzone)	Overlay (applies only in the area affected by the Overlay)
		<p>Transport, Access and Parking [Movement Systems]: PO 1.1, 1.2, 1.3, 1.4</p> <p>Transport, Access and Parking [Sightlines]: PO 2.1, 2.2</p> <p>Transport, Access and Parking [Vehicle Access]: PO 3.1, 3.3, 3.4, 3.5, 3.7, 3.8, 3.9</p> <p>Transport, Access and Parking [Vehicle Parking Rates]: PO 5.1</p> <p>Transport, Access and Parking [Vehicle Parking Areas]: PO 6.1, 6.2, 6.5, 6.6</p>		<p>Mt Lofty Ranges Catchment (Area 2): All</p> <p>Murray Darling Basin: All</p> <p>Native Vegetation: All</p> <p>Non-stop Corridor: All</p> <p>Prescribed Water Resources Area: All</p> <p>Prescribed Watercourses: All</p> <p>Prescribed Wells Area: All</p> <p>River Murray Flood Plain: All</p> <p>River Murray Tributaries Area: All</p> <p>Sloping Land: All</p> <p>State Heritage Area: All</p> <p>State Heritage Place: All</p> <p>State Significant Native Vegetation: All</p> <p>Strategic Infrastructure Gas Pipelines: All</p> <p>Traffic Generating Development: All</p> <p>Urban Transport Routes: All</p> <p>Water Protection Area: All</p> <p>Water Resources: All</p>
Store	<p>[Land Use and Intensity]: PO 1.1, 1.2</p> <p>[Built Form and Character]: PO 2.1, 2.2</p> <p>[Building Height and Setbacks]: PO 3.1, 3.2, 3.3, 3.4, 3.5, 3.6</p> <p>[Landscaping]: PO 5.1, 5.2</p> <p>[Concept Plans]: PO 7.1</p>	<p>Clearance from Overhead Powerlines: PO 1.1</p> <p>Design in Rural Areas [On-site Waste Treatment Systems]: PO 6.1</p> <p>Design in Urban Areas [All development – External appearance]: PO 1.4, 1.5</p> <p>Design in Urban Areas [All development – Water Sensitive Urban Design]: PO 5.1</p> <p>Design in Urban Areas [Car Parking Appearance]: PO 6.2</p> <p>Design in Urban Areas [All Non-Residential Development – Water Sensitive Design]: PO 42.1</p> <p>Infrastructure and Renewable Energy Facilities [Water Supply]: PO 11.1</p> <p>Infrastructure and Renewable Energy Facilities [Wastewater Services]: PO 12.1, 12.2</p>	None	<p>Airport Building Heights (Aircraft Landing Area): PO 1.1</p> <p>Airport Building Heights (Regulated): PO 1.1, 1.2</p> <p>Building Near Airfields: PO 1.1, 1.2</p> <p>Character Area: All</p> <p>Character Preservation District: All</p> <p>Coastal Areas: All</p> <p>Defence Aviation Area: PO 1.1, 1.3</p> <p>Future Road Widening: All</p> <p>Hazards (Bushfire - High Risk): All</p> <p>Hazards (Bushfire - Medium Risk): All</p> <p>Hazards (Bushfire - General Risk): All</p>

Class of Development	Applicable Policies			
	Zone	General Development Policies	Subzone (applies only in the area affected by the Subzone)	Overlay (applies only in the area affected by the Overlay)
		<p>Interface Between Land Uses [General Land Use Compatibility]: PO 1.2</p> <p>Interface Between Land Uses [Hours of Operation]: PO 2.1</p> <p>Interface Between Land Uses [Activities Generating Noise or Vibration]: PO 4.2</p> <p>Interface Between Land Uses [Light Spill]: PO 6.1, 6.2</p> <p>Transport, Access and Parking [Movement Systems]: PO 1.1, 1.2, 1.3, 1.4</p> <p>Transport, Access and Parking [Sightlines]: PO 2.1, 2.2</p> <p>Transport, Access and Parking [Vehicle Access]: PO 3.1, 3.3, 3.4, 3.5, 3.7, 3.8, 3.9</p> <p>Transport, Access and Parking [Vehicle Parking Rates]: PO 5.1</p> <p>Transport, Access and Parking [Vehicle Parking Areas]: PO 6.1, 6.2, 6.5, 6.6</p>		<p>Hazards (Bushfire - Regional): All</p> <p>Hazards (Flooding): All</p> <p>Historic Area: All</p> <p>Key Outback and Rural Routes: All</p> <p>Key Railway Crossings: All</p> <p>Local Heritage Place: All</p> <p>Major Transport Routes: All</p> <p>Marine Parks (Managed Use): All</p> <p>Mt Lofty Ranges Catchment (Area 2): All</p> <p>Murray Darling Basin: All</p> <p>Native Vegetation: All</p> <p>Non-stop Corridor: All</p> <p>Prescribed Water Resources Area: All</p> <p>Prescribed Watercourses: All</p> <p>Prescribed Wells Area: All</p> <p>River Murray Flood Plain: All</p> <p>River Murray Tributaries Area: All</p> <p>Sloping Land: All</p> <p>State Heritage Area: All</p> <p>State Heritage Place: All</p> <p>State Significant Native Vegetation: All</p> <p>Strategic Infrastructure Gas Pipelines: All</p> <p>Traffic Generating Development: All</p> <p>Urban Transport Routes: All</p> <p>Water Protection Area: All</p> <p>Water Resources: All</p>
Telecommunications facility	None	<p>Infrastructure and Renewable Energy Facilities [Telecommunication Facilities]: PO 6.1, 6.2</p>	None	<p>Airport Building Heights (Aircraft Landing Area): PO 1.1</p> <p>Airport Building Heights (Regulated): PO 1.1, 1.2</p> <p>Building Near Airfields: PO 1.1, 1.2</p> <p>Character Area: All</p>

Class of Development	Applicable Policies			
	Zone	General Development Policies	Subzone (applies only in the area affected by the Subzone)	Overlay (applies only in the area affected by the Overlay)
				Character Preservation District: All Coastal Areas: All Defence Aviation Area: PO 1.1, 1.3 Future Road Widening: All Hazards (Flooding): All Historic Area: All Key Outback and Rural Routes: PO 8.1, 10.1 Key Railway Crossings: All Local Heritage Place: All Major Transport Routes: PO 8.1, 10.1 Marine Parks (Managed Use): All Mt Lofty Ranges Catchment (Area 2): All Murray Darling Basin: All Native Vegetation: All Non-stop Corridor: All River Murray Flood Plain: All River Murray Tributaries Area: All Sloping Land: All State Heritage Area: All State Heritage Place: All State Significant Native Vegetation: All Strategic Infrastructure Gas Pipelines: All Urban Transport Routes: PO 8.1, 10.1 Water Protection Area: All Water Resources: All
Tourist accommodation	[Land Use and Intensity]: PO 1.1, 1.2 [Built Form and Character]: PO 2.1, 2.2 [Building Height and Setbacks]: PO 3.1, 3.2, 3.3, 3.4, 3.5, 3.6	Clearance from Overhead Powerlines: PO 1.1 Design in Rural Areas [On-site Waste Treatment Systems]: PO 6.1 Design in Urban Areas [All development – External appearance]: PO 1.4, 1.5	None	Airport Building Heights (Aircraft Landing Area): PO 1.1 Airport Building Heights (Regulated): PO 1.1, 1.2 Building Near Airfields: PO 1.1, 1.2 Character Area: All Character Preservation District: All

Class of Development	Applicable Policies			
	Zone	General Development Policies	Subzone (applies only in the area affected by the Subzone)	Overlay (applies only in the area affected by the Overlay)
	<p>The following policies are applicable to the assessment of the identified Class of Development.</p> <p>Policies referred to are Performance Outcome policies, and any associated Designated Performance Features. Relevant Desired Outcomes are not listed, but automatically apply in relation to a Performance Assessed Development.</p> <p>Where a development comprises more than one Class of Development the relevant policies will be taken to be the sum of the applicable policies for each Class of Development.</p>			
	<p>[Landscaping]: PO 5.1, 5.2</p> <p>[Concept Plans]: PO 7.1</p>	<p>Design in Urban Areas [All development – Water Sensitive Urban Design]: PO 5.1</p> <p>Design in Urban Areas [Car Parking Appearance]: PO 6.2</p> <p>Design in Urban Areas [All Non-Residential Development – Water Sensitive Design]: PO 42.1</p> <p>Infrastructure and Renewable Energy Facilities [Water Supply]: PO 11.1</p> <p>Infrastructure and Renewable Energy Facilities [Wastewater Services]: PO 12.1, 12.2</p> <p>Interface Between Land Uses [General Land Use Compatibility]: PO 1.2</p> <p>Interface Between Land Uses [Hours of Operation]: PO 2.1</p> <p>Interface Between Land Uses [Activities Generating Noise or Vibration]: PO 4.2</p> <p>Interface Between Land Uses [Light Spill]: PO 6.1, 6.2</p> <p>Transport, Access and Parking [Movement Systems]: PO 1.1, 1.2, 1.3, 1.4</p> <p>Transport, Access and Parking [Sightlines]: PO 2.1, 2.2</p> <p>Transport, Access and Parking [Vehicle Access]: PO 3.1, 3.3, 3.4, 3.5, 3.7, 3.8, 3.9</p> <p>Transport, Access and Parking [Vehicle Parking Rates]: PO 5.1</p> <p>Transport, Access and Parking [Vehicle Parking Areas]: PO 6.1, 6.2, 6.5, 6.6</p>		<p>Coastal Areas: All</p> <p>Defence Aviation Area: PO 1.1, 1.3</p> <p>Future Road Widening: All</p> <p>Hazards (Bushfire - High Risk): All</p> <p>Hazards (Bushfire - Medium Risk): All</p> <p>Hazards (Bushfire - General Risk): All</p> <p>Hazards (Bushfire - Regional): All</p> <p>Hazards (Flooding): All</p> <p>Historic Area: All</p> <p>Key Outback and Rural Routes: All</p> <p>Key Railway Crossings: All</p> <p>Local Heritage Place: All</p> <p>Major Transport Routes: All</p> <p>Marine Parks (Managed Use): All</p> <p>Mt Lofty Ranges Catchment (Area 2): All</p> <p>Murray Darling Basin: All</p> <p>Native Vegetation: All</p> <p>Non-stop Corridor: All</p> <p>Prescribed Water Resources Area: All</p> <p>Prescribed Watercourses: All</p> <p>Prescribed Wells Area: All</p> <p>River Murray Flood Plain: All</p> <p>River Murray Tributaries Area: All</p> <p>Sloping Land: All</p> <p>State Heritage Area: All</p> <p>State Heritage Place: All</p> <p>State Significant Native Vegetation: All</p> <p>Strategic Infrastructure Gas Pipelines: All</p> <p>Traffic Generating Development: All</p> <p>Urban Transport Routes: All</p> <p>Water Protection Area: All</p>

Class of Development	Applicable Policies			
	Zone	General Development Policies	Subzone (applies only in the area affected by the Subzone)	Overlay (applies only in the area affected by the Overlay)
				Water Resources: All
Tree damaging activity	None	None	None	Regulated Tree: All
Warehouse	<p>[Land Use and Intensity]: PO 1.1, 1.2</p> <p>[Built Form and Character]: PO 2.1, 2.2</p> <p>[Building Height and Setbacks]: PO 3.1, 3.2, 3.3, 3.4, 3.5, 3.6</p> <p>[Landscaping]: PO 5.1, 5.2</p> <p>[Concept Plans]: PO 7.1</p>	<p>Clearance from Overhead Powerlines: PO 1.1</p> <p>Design in Rural Areas [On-site Waste Treatment Systems]: PO 6.1</p> <p>Design in Urban Areas [All development – External appearance]: PO 1.4, 1.5</p> <p>Design in Urban Areas [All development – Water Sensitive Urban Design]: PO 5.1</p> <p>Design in Urban Areas [Car Parking Appearance]: PO 6.2</p> <p>Design in Urban Areas [All Non-Residential Development – Water Sensitive Design]: PO 42.1</p> <p>Infrastructure and Renewable Energy Facilities [Water Supply]: PO 11.1</p> <p>Infrastructure and Renewable Energy Facilities [Wastewater Services]: PO 12.1, 12.2</p> <p>Interface Between Land Uses [General Land Use Compatibility]: PO 1.2</p> <p>Interface Between Land Uses [Hours of Operation]: PO 2.1</p> <p>Interface Between Land Uses [Activities Generating Noise or Vibration]: PO 4.2</p> <p>Interface Between Land Uses [Light Spill]: PO 6.1, 6.2</p> <p>Transport, Access and Parking [Movement Systems]: PO 1.1, 1.2, 1.3, 1.4</p> <p>Transport, Access and Parking [Sightlines]: PO 2.1, 2.2</p> <p>Transport, Access and Parking [Vehicle Access]: PO 3.1, 3.3, 3.4, 3.5, 3.7, 3.8, 3.9</p> <p>Transport, Access and Parking [Vehicle Parking Rates]: PO 5.1</p> <p>Transport, Access and Parking [Vehicle Parking Areas]: PO 6.1, 6.2, 6.5, 6.6</p>	None	<p>Airport Building Heights (Aircraft Landing Area): PO 1.1</p> <p>Airport Building Heights (Regulated): PO 1.1, 1.2</p> <p>Building Near Airfields: PO 1.1, 1.2</p> <p>Character Area: All</p> <p>Character Preservation District: All</p> <p>Coastal Areas: All</p> <p>Defence Aviation Area: PO 1.1, 1.3</p> <p>Future Road Widening: All</p> <p>Hazards (Bushfire - High Risk): All</p> <p>Hazards (Bushfire - Medium Risk): All</p> <p>Hazards (Bushfire - General Risk): All</p> <p>Hazards (Bushfire - Regional): All</p> <p>Hazards (Flooding): All</p> <p>Historic Area: All</p> <p>Key Outback and Rural Routes: All</p> <p>Key Railway Crossings: All</p> <p>Local Heritage Place: All</p> <p>Major Transport Routes: All</p> <p>Marine Parks (Managed Use): All</p> <p>Mt Lofty Ranges Catchment (Area 2): All</p> <p>Murray Darling Basin: All</p> <p>Native Vegetation: All</p> <p>Non-stop Corridor: All</p> <p>Prescribed Water Resources Area: All</p> <p>Prescribed Watercourses: All</p> <p>Prescribed Wells Area: All</p> <p>River Murray Flood Plain: All</p> <p>River Murray Tributaries Area: All</p>

Class of Development	Applicable Policies			
	Zone	General Development Policies	Subzone (applies only in the area affected by the Subzone)	Overlay (applies only in the area affected by the Overlay)
				Sloping Land: All State Heritage Area: All State Heritage Place: All State Significant Native Vegetation: All Strategic Infrastructure Gas Pipelines: All Traffic Generating Development: All Urban Transport Routes: All Water Protection Area: All Water Resources: All
All other Code Assessed Development	All	All	None	Any Relevant Overlay: All

Table 4 – Restricted Development Classification

Class of Development The following Classes of Development are classified as Restricted subject to any 'Exclusions'	Exclusions
Industry	Light industry
Shop	Where: (d) the gross leasable floor area is no more than 1000m ² : or (e) it is a bulky goods outlet; or (f) it is ancillary to a light industry on the same allotment.
Waste reception, storage, treatment or disposal	
Wrecking yard	

Assessment Provisions

Desired Outcomes (DO)

DO 1

A zone supporting a diverse range of low impact light industrial, commercial and business activities that complement the role of other zones accommodating significant industrial, shopping and business activities.

Performance Outcomes and Deemed to Satisfy / Designated Performance Outcome Criteria

Land Use and Intensity

PO 1.1

A range of employment generating light industrial, service trade, motor repair and other compatible businesses servicing the local community that do not produce objectionable emissions.

DTS/DPF 1.1

Development comprises one or more of the following land uses:

- Bulky goods outlet
- Consulting room
- Indoor recreation facility
- Light industry
- Office
- Research facility
- Service trade premises
- Shop
- Store
- Training facility
- Tourist accommodation
- Retail fuel outlet
- Place of worship
- Motor repair station.

PO 1.2

Shops, other than bulky goods outlets, provide a local convenience service to meet the day to day needs of the local community and surrounding businesses as well as support the sale of products made on-site as a supplement to a business activity to enhance local job opportunities.

DTS/DPF1.2

Shop:

- a. with a gross leasable floor area up to 500m²;
- b. in the form of a bulky goods outlet; or
- c. ancillary to and located on the same allotment as a light industry.

Built Form and Character

PO 2.1

Development achieves distinctive building, landscape and streetscape design to achieve high visual and environmental amenity particularly along arterial roads, zone boundaries and public open spaces.

DTS/DPF 2.1

None are applicable.

PO 2.2

Building facades facing a boundary of a zone primarily intended to accommodate residential development, public roads, or public open space incorporate design elements to add visual interest by considering the following:

- (a) a variety of building finishes and avoid elevations that consist solely of metal cladding;
- (b) using materials with a low reflectivity; and
- (c) techniques to add visual interest and reduce large expanses of blank walls including modulation and incorporation of offices and showrooms along elevations visible to a public road.

DTS/DPF 2.2

None are applicable.

Building height and setbacks

PO 3.1

Buildings set back from the primary street boundary to contribute to a consistent streetscape.

DTS/DPF3.1

Buildings are no closer to the primary street frontage than:

- (a) the average of existing buildings on adjoining sites with the same primary street frontage and, if there is only one such building, the setback of that building; or
- (b) where no building exists on an adjoining site, 3m or more.

PO 3.2

Buildings set back from a secondary street boundary to accommodate the provision of landscaping between buildings and the street to enhance the appearance of land and buildings when viewed from the street.

DTS/DPF3.2

Buildings are no closer than 2m to the secondary street boundary.

PO 3.3

Buildings set back from rear access ways to provide adequate manoeuvrability for vehicles to enter and exit the site.

DTS/DPF3.3

Buildings are setback from the rear access way:

- (a) where the access way is 6.5m wide or more, no requirement; or
- (b) where the access way is less than 6.5m wide, the distance equal to the additional width required to make the access way at least 6.5m wide.

PO 3.4

Buildings are sited to accommodate vehicle access to the rear of a site for deliveries, maintenance and emergency purposes.

DTS/DPF3.4

Buildings setback at least 3m from at least one side boundary, unless an alternative means for vehicular access to the rear of the site is available.

PO 3.5

Buildings adjoining a zone primarily intended to accommodate residential development are sited and designed to minimise visual impacts from building bulk.

DTS/DPF 3.5

Buildings constructed within a building envelope provided by a 45 degree plane, measured from a height of 3m above natural ground level at the allotment boundary of a zone primarily intended to accommodate residential development as shown in the following diagram, except where the relevant boundary is a southern boundary, or where this boundary is the primary street boundary.

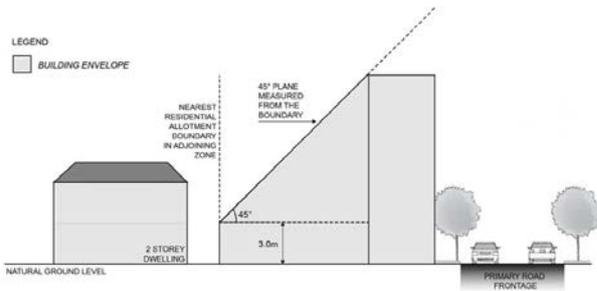

PO 3.6

Buildings are constructed to minimise overshadowing of sensitive receivers outside the zone.

DTS/DPF 3.6

Buildings on sites with a southern boundary adjoining a residential allotment within a different zone are constructed within a building envelope provided by a 30-degree plane grading north measured from a height of 3m above natural ground level at the southern boundary, as shown in the following diagram:

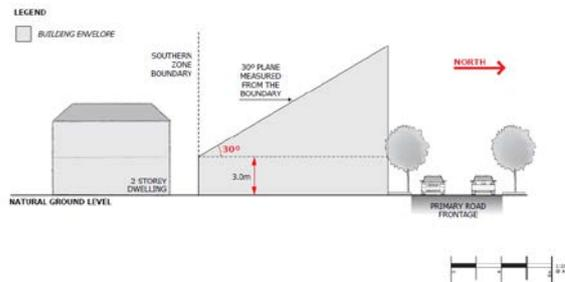

Site Dimensions and Land Division

PO 4.1

Land division that creates allotments that vary in size and are suitable for a variety of commercial and business activities.

DTS/DPF4.1

Allotments have:

- an area of 1250m² or more; and
- a frontage of 20 metres or more.

Landscaping

PO 5.1

Landscaping provided to enhance the visual appearance of development when viewed from public roads and thoroughfares.

DTS/DPF 5.1

Other than to accommodate a lawfully existing or authorised driveway or access point or an access point for which consent has been granted as part of an application for the division of land, a landscaped area is provided within the development site (excluding any land required for road widening purposes):

- where a building is setback less than 3m from the street boundary – 1m or more within the area remaining between a relevant building and the street boundary; or
- at least 1.5m wide.

PO 5.2

Development incorporates areas for landscaping to enhance the overall amenity of the site and locality.

DTS/DPF 5.2

Landscape areas comprise:

- (c) not less than 10 percent of the site;
- (d) a dimension of at least 1.5m.

Advertisements

PO 6.1

Freestanding advertisements are not visually dominant within the locality.

DTS/DPF 6.1

Freestanding advertisements:

- (a) do not exceed 4m in height above natural ground level; and
- (b) do not have a face that exceeds 3m².

Notification of Performance assessed development

All classes of performance assessed development are excluded from notification except where it involves any of the following:

(a)

Placement of Notices – Exemptions for Performance Assessed Development

None specified.

Placement of Notices – Exemptions for Restricted Development

None specified.

Suburban Activity Centre Zone

Table 1 – Accepted Development Classification

Class of Development The following Classes of Development are classified as Accepted Development subject to meeting the 'Accepted Development Classification Criteria'	Accepted Development Classification Criteria
Air handling unit, air conditioning system or exhaust fan including any associated components and any associated building alteration or addition necessary or incidental to its installation Except where any of the following apply: <ul style="list-style-type: none"> • Historic Area Overlay • Local Heritage Place Overlay • State Heritage Area Overlay • State Heritage Place Overlay 	<ol style="list-style-type: none"> 1 The item will be installed on or within an existing building 2 The item being installed does not encroach on a public street or affect the ability of the building to resist the spread of fire. 3 If the associated building is in a Local Heritage Area Overlay or State Heritage Area Overlay, no part of the item, when installed, will be able to be seen by a person standing at ground level in a public street.
Internal building work Except where any of the following apply: <ul style="list-style-type: none"> • A Local Heritage Place identified in the Local Heritage Place Overlay • State Heritage Area Overlay • A State Heritage Place identified in the State Heritage Place Overlay 	<ol style="list-style-type: none"> 9 There will be no increase in the total floor area of the building 10 There will be no alteration to the external appearance of the building.
Shade sail Except where any of the following apply: <ul style="list-style-type: none"> • Coastal Areas Overlay • Character Area Overlay 	<ol style="list-style-type: none"> 22 The development will not be built, or encroach, on an area that is, or will be, required for a sewerage system or waste control system 23 Shade sail consists of permeable material

<ul style="list-style-type: none"> • Historic Area Overlay • Local Heritage Place Overlay • State Heritage Area Overlay • State Heritage Place Overlay • Native Vegetation Overlay • State Significant Native Vegetation Overlay • River Murray Flood Plain Overlay • Sloping Land Overlay • Water Resources Overlay 	<p>24 The total area of the sail - does not exceed 40m²</p> <p>25 No part of the shade sail will be:</p> <ul style="list-style-type: none"> (a) 3m above ground or floor level (depending on where it is situated) at any place within 900mm of a boundary of the allotment (b) 5m above ground or floor level (depending on where it is situated) within any other part of the allotment <p>26 Primary street setback – at least as far back as the building line of the building to which it is ancillary</p> <p>27 If any part of the sail will be situated on a boundary of the allotment, the length of sail along a boundary does not exceed 8m</p> <p>28 In a case where any part of the sail or a supporting structure will be situated on a side boundary of the allotment – the length of the sail and any such supporting structure together with all relevant walls or structures located along the boundary will not exceed 45% of the length of the boundary.</p>
<p>Solar photovoltaic panels (roof mounted) Except where any of the following apply:</p> <ul style="list-style-type: none"> • Historic Area Overlay • A Local Heritage Place identified in the Local Heritage Place Overlay • State Heritage Area Overlay • A State Heritage Place identified in the State Heritage Place Overlay 	<p>10 Panels are installed parallel to the roof of a building and with the underside surface of the panel not being more than 100mm above the surface of the roof</p> <p>11 Panels and associated components do not overhang any part of the roof</p> <p>12 Does not apply to system with a generating capacity of more than 5MW that is to be connected to the State's power system.</p>
<p>Water tank (underground) Except where any of the following apply:</p> <ul style="list-style-type: none"> • Coastal Areas Overlay • Native Vegetation Overlay • State Significant Native Vegetation Overlay • Sloping Land Overlay • Water Resources Overlay 	<p>7 The development will not be built, or encroach, on an area that is, or will be, required for a sewerage system or waste control system</p> <p>8 The tank (including any associated pump) is located wholly below the level of the ground.</p>

Table 2 – Deemed-to-Satisfy Development Classification

Class of Development The following Classes of Development are classified as Deemed-to-Satisfy Development subject to meeting the 'Deemed-to-Satisfy Development Classification Criteria'	Deemed-to-Satisfy Development Classification Criteria Provisions referred to are Deemed-to-Satisfy Criteria Where a development comprises more than one Class of Development the relevant criteria will be taken to be the sum of the criteria for each Class of Development.			
	Zone	General Development Policies	Subzone (applies only in the area affected by the Subzone)	Overlay (applies only in the area affected by the Overlay)
Advertisement attached to a building or structure Except where any of the following apply: <ul style="list-style-type: none"> Advertising Near Signalised Intersections Overlay Character Area Overlay Historic Area Overlay Local Heritage Place Overlay State Heritage Area Overlay State Heritage Place Overlay 	None	Clearance from Overhead Powerlines: DTS 1.1 Advertisements [Appearance]: DTS 1.1, 1.3, 1.4 Advertisements [Proliferation of Advertisements]: DTS 2.1, 2.2 Advertisements [Advertising Content]: DTS 3.1 Advertisements [Amenity Content]: DTS 4.1 Advertising [Safety]: DTS 5.1, 5.2, 5.3, 5.4, 5.5	None	None
Freestanding advertisement located on private land Except where any of the following apply: <ul style="list-style-type: none"> Advertising Near Signalised Intersections Overlay Character Area Overlay Historic Area Overlay Local Heritage Place Overlay State Heritage Area Overlay State Heritage Place Overlay 	[Advertisements]: DTS 5.1	Clearance from Overhead Powerlines: DTS 1.1 Advertisements [Appearance]: DTS 1.1, 1.3, 1.4 Advertisements [Proliferation of Advertisements]: DTS 2.1, 2.2 Advertisements [Advertising Content]: DTS 3.1 Advertisements [Amenity Content]: DTS 4.1 Advertising [Safety]: DTS 5.1, 5.2, 5.3, 5.4, 5.5	None	Airport Building Heights (Aircraft Landing Areas) Overlay: All DTS Airport Building Heights (Regulated) Overlay: All DTS Future Road Widening Overlay: DTS 1.1
Change of use to a <u>shop, office, consulting room</u> or any combination of these uses where the area to be occupied by the proposed development is located in an existing building and utilises existing on-site car parking Except where any of the following apply: <ul style="list-style-type: none"> State Heritage Area Overlay State Heritage Place Overlay 	None	Transport, Access and Parking [Vehicle Parking Rates]: DTS 5.1	None	Major Urban Transport Routes Overlay: [Access – Existing Access Points] DTS 3.1 Key Outback and Rural Routes Overlay: Access – Existing Access Points] DTS 3.1
Land division	None	Land Division in Urban Areas [All Land Division – Allotment Configuration]: DTS 1.1	None	None
Temporary change of use to a <u>sales office</u> within an existing building for no more than 2 years	None	None	None	None
The construction of a new building in the same, or substantially the same, position as a building which was	None	None	None	None

Class of Development The following Classes of Development are classified as Deemed-to-Satisfy Development subject to meeting the 'Deemed-to-Satisfy Development Classification Criteria'	Deemed-to-Satisfy Development Classification Criteria Provisions referred to are Deemed-to-Satisfy Criteria Where a development comprises more than one Class of Development the relevant criteria will be taken to be the sum of the criteria for each Class of Development.			
	Zone	General Development Policies	Subzone (applies only in the area affected by the Subzone)	Overlay (applies only in the area affected by the Overlay)
<p>demolished within the previous 3 years where the new building has the same, or substantially the same, layout and external appearance as the previous building</p> <p>Except where any of the following apply:</p> <ul style="list-style-type: none"> • Historic Area Overlay • Local Heritage Place Overlay • State Heritage Area Overlay • State Heritage Place Overlay 				

Table 3 – Applicable Policies for Performance Assessed Development

Class of Development	Applicable Policies			
	Zone	General Development Policies	Subzone (applies only in the area affected by the Subzone)	Overlay (applies only in the area affected by the Overlay)
Advertisement	[Advertisements]: PO 5.1	Clearance from Overhead Powerlines: PO 1.1 Advertisements: All	None	Advertising Near Signalised Intersections Overlay: All Aircraft Noise Exposure Overlay: All Airport Building Heights (Aircraft Landing Area) Overlay: All Airport Building Heights (Regulated) Overlay: All Building Near Airfields Overlay: All Character Area Overlay: All Defence Aviation Area Overlay: All Future Road Widening Overlay: All Historic Area Overlay: All Key Railway Crossings Overlay: All Local Heritage Place Overlay: All Major Urban Transport Routes Overlay: All Marine Parks (Managed Use) Overlay: All Murray Darling Basin Overlay: All Native Vegetation Overlay: All Non-stop Corridor Overlay: All River Murray Flood Plain Overlay: All River Murray Tributaries Area Overlay: All State Heritage Area Overlay: All State Heritage Place Overlay: All State Significant Native Vegetation Overlay: All Strategic Infrastructure (Gas Pipelines) Overlay: All

Class of Development	Applicable Policies			
	Zone	General Development Policies	Subzone (applies only in the area affected by the Subzone)	Overlay (applies only in the area affected by the Overlay)
				Urban Transport Routes Overlay: All
Bulky goods outlet	<p>[Land use and intensity]: PO 1.1 and 1.5</p> <p>[Built form and character]: All</p> <p>[Building height and setbacks]: All</p> <p>[Concept Plans]: All</p>	<p>Clearance from Overhead Powerlines: PO 1.1</p> <p>Design in Urban Areas [All Development]: All</p> <p>Design in Urban Areas [All Development – 4 or More Building Levels]: All</p> <p>Design in Urban Areas [All Non Residential Development]: All</p> <p>Interface Between Land Uses [Hours of Operation]: PO 2.1</p> <p>Interface Between Land Uses [Overshadowing]: PO 3.1, 3.2</p> <p>Interface Between Land Uses [Activities Generating Noise or Vibration]: PO 4.1, 4.2</p> <p>Interface Between Land Uses [Light Spill]: PO 6.1, 6.2</p> <p>Infrastructure and Renewable Energy Facilities [Water Supply]: PO 11.1</p> <p>Infrastructure and Renewable Energy Facilities [Wastewater Services]: PO 12.1</p> <p>Transport, Access and Parking [Movement Systems]: All</p> <p>Transport, Access and Parking [Sightlines]: All</p> <p>Transport, Access and Parking [Vehicle Access]: All</p> <p>Transport, Access and Parking [Access to People with Disabilities]: All</p> <p>Transport, Access and Parking [Vehicle Parking Rates]: All</p> <p>Transport, Access and Parking [Vehicle Parking Areas]: All</p> <p>Transport, Access and Parking [Undercroft and Below Ground Garaging and Parking of Vehicles]: All</p>	None	<p>Airport Building Heights (Regulated) Overlay: All</p> <p>Aircraft Noise Exposure Overlay: All</p> <p>Airport Building Heights (Aircraft Landing Area) Overlay: All</p> <p>Building Near Airfields Overlay: All</p> <p>Character Area Overlay: All</p> <p>Coastal Areas Overlay: All</p> <p>Defence Aviation Area Overlay: All</p> <p>Design Overlay: All</p> <p>Environment and Food Production Area Overlay: All</p> <p>Future Road Widening Overlay: All</p> <p>Hazards (Bushfire – High Risk) Overlay: All</p> <p>Hazards (Bushfire – Medium Risk) Overlay: All</p> <p>Hazards (Bushfire – General Risk) Overlay: All</p> <p>Hazards (Bushfire – Urban Interface) Overlay: All</p> <p>Hazards (Bushfire – Regional) Overlay: All</p> <p>Hazards (Flooding) Overlay: All</p> <p>Historic Area Overlay: All</p> <p>Key Railway Crossings Overlay: All</p> <p>Local Heritage Place Overlay: All</p> <p>Major Urban Transport Routes Overlay: All</p> <p>Marine Parks (Managed Use) Overlay: All</p> <p>Mt Lofty Ranges Catchment (Area 2) Overlay: All</p>

Class of Development	Applicable Policies			
	Zone	General Development Policies	Subzone (applies only in the area affected by the Subzone)	Overlay (applies only in the area affected by the Overlay)
		Transport, Access and Parking [Bicycle Parking in Designated Areas]: All		Murray Darling Basin Overlay: All Native Vegetation Overlay: All Noise and Air Emissions Overlay: All Non-stop Corridor Overlay: All Prescribed Watercourses Overlay: All Prescribed Water Resources Area Overlay: All Prescribed Wells Area Overlay: All Regulated Trees Overlay: All River Murray Flood Plain Overlay: All River Murray Tributaries Area Overlay: All Sloping Land Overlay: All State Heritage Area Overlay: All State Heritage Place Overlay: All State Significant Native Vegetation Overlay: All Strategic Infrastructure (Gas Pipelines) Overlay: All Traffic Generating Development Overlay: All Urban Transport Routes Overlay: All Water Protection Area Overlay: All Water Resources Overlay: All
Cinema	[Land use and intensity]: PO 1.1 [Built form and character]: All [Building height and setbacks]: All [Concept Plans]: All	Clearance from Overhead Powerlines: PO 1.1 Design in Urban Areas [All Development]: All Design in Urban Areas [All Development – 4 or More Building Levels]: All Design in Urban Areas [All Non Residential Development]: All	None	Airport Building Heights (Regulated) Overlay: All Aircraft Noise Exposure Overlay: All Airport Building Heights (Aircraft Landing Area) Overlay: All Building Near Airfields Overlay: All

Class of Development	Applicable Policies The following policies are applicable to the assessment of the identified Class of Development. Policies referred to are Performance Outcome policies, and any associated Designated Performance Features. Relevant Desired Outcomes are not listed, but automatically apply in relation to a Performance Assessed Development. Where a development comprises more than one Class of Development the relevant policies will be taken to be the sum of the applicable policies for each Class of Development.			
	Zone	General Development Policies	Subzone (applies only in the area affected by the Subzone)	Overlay (applies only in the area affected by the Overlay)
		Interface Between Land Uses [Hours of Operation]: PO 2.1 Interface Between Land Uses [Overshadowing]: PO 3.1, 3.2 Interface Between Land Uses [Activities Generating Noise or Vibration]: PO 4.1, 4.2, 4.5, 4.6 Interface Between Lands Uses [Air Quality]: PO 5.2 Interface Between Land Uses [Light Spill]: PO 6.1, 6.2 Infrastructure and Renewable Energy Facilities [Water Supply]: PO 11.1 Infrastructure and Renewable Energy Facilities [Wastewater Services]: PO 12.1 Transport, Access and Parking [Movement Systems]: All Transport, Access and Parking [Sightlines]: All Transport, Access and Parking [Vehicle Access]: All Transport, Access and Parking [Access to People with Disabilities]: All Transport, Access and Parking [Vehicle Parking Rates]: All Transport, Access and Parking [Vehicle Parking Areas]: All Transport, Access and Parking [Undercroft and Below Ground Garaging and Parking of Vehicles]: All Transport, Access and Parking [Bicycle Parking in Designated Areas]: All		Character Area Overlay: All Coastal Areas Overlay: All Defence Aviation Area Overlay: All Design Overlay: All Environment and Food Production Area Overlay: All Future Road Widening Overlay: All Hazards (Bushfire – High Risk) Overlay: All Hazards (Bushfire – Medium Risk) Overlay: All Hazards (Bushfire – General Risk) Overlay: All Hazards (Bushfire – Urban Interface) Overlay: All Hazards (Bushfire – Regional) Overlay: All Hazards (Flooding) Overlay: All Historic Area Overlay: All Key Railway Crossings Overlay: All Local Heritage Place Overlay: All Major Urban Transport Routes Overlay: All Marine Parks (Managed Use) Overlay: All Mt Lofty Ranges Catchment (Area 2) Overlay: All Murray Darling Basin Overlay: All Native Vegetation Overlay: All Noise and Air Emissions Overlay: All Non-stop Corridor Overlay: All Prescribed Watercourses Overlay: All

Class of Development	Applicable Policies			
	Zone	General Development Policies	Subzone (applies only in the area affected by the Subzone)	Overlay (applies only in the area affected by the Overlay)
				<p>Prescribed Water Resources Area Overlay: All</p> <p>Prescribed Wells Area Overlay: All</p> <p>Regulated Trees Overlay: All</p> <p>River Murray Flood Plain Overlay: All</p> <p>River Murray Tributaries Area Overlay: All</p> <p>Sloping Land Overlay: All</p> <p>State Heritage Area Overlay: All</p> <p>State Heritage Place Overlay: All</p> <p>State Significant Native Vegetation Overlay: All</p> <p>Strategic Infrastructure (Gas Pipelines) Overlay: All</p> <p>Traffic Generating Development Overlay: All</p> <p>Urban Transport Routes Overlay: All</p> <p>Water Protection Area Overlay: All</p> <p>Water Resources Overlay: All</p>
<u>Community facility</u>	<p>[Land use and intensity]: PO 1.1</p> <p>[Built form and character]: All</p> <p>[Building height and setbacks]: All</p> <p>[Concept Plans]: All</p>	<p>Clearance from Overhead Powerlines: PO 1.1</p> <p>Design in Urban Areas [All Development]: All</p> <p>Design in Urban Areas [All Development – 4 or More Building Levels]: All</p> <p>Design in Urban Areas [All Non Residential Development]: All P</p> <p>Interface Between Land Uses [Hours of Operation]: PO 2.1</p> <p>Interface Between Land Uses [Overshadowing]: PO 3.1, 3.2</p> <p>Interface Between Land Uses [Activities Generating Noise or Vibration]: PO 4.1, 4.2</p> <p>Interface Between Land Uses [Light Spill]: PO 6.1, 6.2</p>	None	<p>Airport Building Heights (Regulated) Overlay: All</p> <p>Aircraft Noise Exposure Overlay: All</p> <p>Airport Building Heights (Aircraft Landing Area) Overlay: All</p> <p>Building Near Airfields Overlay: All</p> <p>Character Area Overlay: All</p> <p>Coastal Areas Overlay: All</p> <p>Defence Aviation Area Overlay: All</p> <p>Design Overlay: All</p> <p>Environment and Food Production Area Overlay: All</p>

Class of Development	Applicable Policies The following policies are applicable to the assessment of the identified Class of Development. Policies referred to are Performance Outcome policies, and any associated Designated Performance Features. Relevant Desired Outcomes are not listed, but automatically apply in relation to a Performance Assessed Development. Where a development comprises more than one Class of Development the relevant policies will be taken to be the sum of the applicable policies for each Class of Development.			
	Zone	General Development Policies	Subzone (applies only in the area affected by the Subzone)	Overlay (applies only in the area affected by the Overlay)
		Infrastructure and Renewable Energy Facilities [Water Supply]: PO 11.1 Infrastructure and Renewable Energy Facilities [Wastewater Services]: PO 12.1 Transport, Access and Parking [Movement Systems]: All Transport, Access and Parking [Sightlines]: All Transport, Access and Parking [Vehicle Access]: All Transport, Access and Parking [Access to People with Disabilities]: All Transport, Access and Parking [Vehicle Parking Rates]: All Transport, Access and Parking [Vehicle Parking Areas]: All Transport, Access and Parking [Undercroft and Below Ground Garaging and Parking of Vehicles]: All Transport, Access and Parking [Bicycle Parking in Designated Areas]: All		Future Road Widening Overlay: All Hazards (Bushfire – High Risk) Overlay: All Hazards (Bushfire – Medium Risk) Overlay: All Hazards (Bushfire – General Risk) Overlay: All Hazards (Bushfire – Urban Interface) Overlay: All Hazards (Bushfire – Regional) Overlay: All Hazards (Flooding) Overlay: All Historic Area Overlay: All Key Railway Crossings Overlay: All Local Heritage Place Overlay: All Major Urban Transport Routes Overlay: All Marine Parks (Managed Use) Overlay: All Mt Lofty Ranges Catchment (Area 2) Overlay: All Murray Darling Basin Overlay: All Native Vegetation Overlay: All Noise and Air Emissions Overlay: All Non-stop Corridor Overlay: All Prescribed Watercourses Overlay: All Prescribed Water Resources Area Overlay: All Prescribed Wells Area Overlay: All Regulated Trees Overlay: All River Murray Flood Plain Overlay: All River Murray Tributaries Area Overlay: All

Class of Development	Applicable Policies			
	Zone	General Development Policies	Subzone (applies only in the area affected by the Subzone)	Overlay (applies only in the area affected by the Overlay)
				Sloping Land Overlay: All State Heritage Area Overlay: All State Heritage Place Overlay: All State Significant Native Vegetation Overlay: All Strategic Infrastructure (Gas Pipelines) Overlay: All Traffic Generating Development Overlay: All Urban Transport Routes Overlay: All Water Protection Area Overlay: All Water Resources Overlay: All
Consulting room	[Land use and intensity]: PO 1.1 [Built form and character]: All [Building height and setbacks]: All [Concept Plans]: All	Clearance from Overhead Powerlines: PO 1.1 Design in Urban Areas [All Development]: All Design in Urban Areas [All Development – 4 or More Building Levels]: All Design in Urban Areas [All Non Residential Development]: All P Interface Between Land Uses [Hours of Operation]: PO 2.1 Interface Between Land Uses [Overshadowing]: PO 3.1, 3.2 Interface Between Land Uses [Activities Generating Noise or Vibration]: PO 4.1, 4.2 Interface Between Land Uses [Light Spill]: PO 6.1, 6.2 Infrastructure and Renewable Energy Facilities [Water Supply]: PO 11.1 Infrastructure and Renewable Energy Facilities [Wastewater Services]: PO 12.1 Transport, Access and Parking [Movement Systems]: All Transport, Access and Parking [Sightlines]: All	None	Airport Building Heights (Regulated) Overlay: All Aircraft Noise Exposure Overlay: All Airport Building Heights (Aircraft Landing Area) Overlay: All Building Near Airfields Overlay: All Character Area Overlay: All Coastal Areas Overlay: All Defence Aviation Area Overlay: All Design Overlay: All Environment and Food Production Area Overlay: All Future Road Widening Overlay: All Hazards (Bushfire – High Risk) Overlay: All Hazards (Bushfire – Medium Risk) Overlay: All Hazards (Bushfire – General Risk) Overlay: All Hazards (Bushfire – Urban Interface) Overlay: All

Class of Development	Applicable Policies The following policies are applicable to the assessment of the identified Class of Development. Policies referred to are Performance Outcome policies, and any associated Designated Performance Features. Relevant Desired Outcomes are not listed, but automatically apply in relation to a Performance Assessed Development. Where a development comprises more than one Class of Development the relevant policies will be taken to be the sum of the applicable policies for each Class of Development.			
	Zone	General Development Policies	Subzone (applies only in the area affected by the Subzone)	Overlay (applies only in the area affected by the Overlay)
		Transport, Access and Parking [Vehicle Access]: All Transport, Access and Parking [Access to People with Disabilities]: All Transport, Access and Parking [Vehicle Parking Rates]: All Transport, Access and Parking [Vehicle Parking Areas]: All Transport, Access and Parking [Undercroft and Below Ground Garaging and Parking of Vehicles]: All Transport, Access and Parking [Bicycle Parking in Designated Areas]: All		Hazards (Bushfire – Regional) Overlay: All Hazards (Flooding) Overlay: All Historic Area Overlay: All Key Railway Crossings Overlay: All Local Heritage Place Overlay: All Major Urban Transport Routes Overlay: All Marine Parks (Managed Use) Overlay: All Mt Lofty Ranges Catchment (Area 2) Overlay: All Murray Darling Basin Overlay: All Native Vegetation Overlay: All Noise and Air Emissions Overlay: All Non-stop Corridor Overlay: All Prescribed Watercourses Overlay: All Prescribed Water Resources Area Overlay: All Prescribed Wells Area Overlay: All Regulated Trees Overlay: All River Murray Flood Plain Overlay: All River Murray Tributaries Area Overlay: All Sloping Land Overlay: All State Heritage Area Overlay: All State Heritage Place Overlay: All State Significant Native Vegetation Overlay: All Strategic Infrastructure (Gas Pipelines) Overlay: All

Class of Development	Applicable Policies			
	Zone	General Development Policies	Subzone (applies only in the area affected by the Subzone)	Overlay (applies only in the area affected by the Overlay)
				Traffic Generating Development Overlay: All Urban Transport Routes Overlay: All Water Protection Area Overlay: All Water Resources Overlay: All
Demolition of a State or Local Heritage Place	None	None	None	Local Heritage Place Overlay: All State Heritage Place Overlay: All
Demolition within the Historic Area Overlay or the State Heritage Area Overlay	All	None	None	Historic Area Overlay: All State Heritage Area Overlay: All
Dwelling Residential flat building	[Land use and intensity]: PO 1.1-1.4 (inclusive) [Built form and character]: All [Building height and setbacks]: All [Concept Plans]: All	Clearance from Overhead Powerlines: PO 1.1 Infrastructure and Renewable Energy Facilities [Water Supply]: PO 11.2 Infrastructure and Renewable Energy Facilities [Wastewater Services]: PO 12.1, 12.2 Transport, Access and Parking [Vehicle Access]: PO 3.1, 3.2, 3.3, 3.4, 3.5, 3.6 Transport, Access and Parking [Vehicle Parking Rates]: PO 5.1 Design in Urban Areas [All Development]: All Design in Urban Areas [All Development – 4 or More Building Levels]: All Design in Urban Areas [All Residential Development]: All Design in Urban Areas [Residential Development – 3 Building Levels or Less]: All Design in Urban Areas [Residential Development – 4 Or More Building Levels (Including Serviced Apartments)]: All Design in Urban Areas [Group Dwellings, Residential Flat Buildings and Battle-Axe Development]: All	None	Affordable Housing Overlay: All Airport Building Heights (Aircraft Landing Area) Overlay: All Airport Building Heights (Regulated) Overlay: All Aircraft Noise Exposure Overlay: All Building Near Airfields Overlay: All Character Area Overlay: All Coastal Areas Overlay: All Defence Aviation Area Overlay: All Design Overlay: All Environment and Food Production Area Overlay: All Future Road Widening Overlay: All Hazards (Bushfire – High Risk) Overlay: All Hazards (Bushfire – Medium Risk) Overlay: All Hazards (Bushfire – General Risk) Overlay: All Hazards (Bushfire – Urban Interface) Overlay: All Hazards (Bushfire – Regional) Overlay: All

Class of Development	Applicable Policies			
	Zone	General Development Policies	Subzone (applies only in the area affected by the Subzone)	Overlay (applies only in the area affected by the Overlay)
		Interface Between Land Uses [General Land Use Compatibility]: PO 1.1 Interface Between Land Uses [Overshadowing]: PO 3.1, 3.2 Interface Between Land Uses [Activities Generating Noise or Vibration]: PO 4.4 Site Contamination: PO 1.1		Hazards (Flooding) Overlay: All Historic Area Overlay: All Key Railway Crossings Overlay: All Local Heritage Place Overlay: All Major Urban Transport Routes Overlay: All Marine Parks (Managed Use) Overlay: All Mt Lofty Ranges Catchment (Area 2) Overlay: All Murray Darling Basin Overlay: All Native Vegetation Overlay: All Noise and Air Emissions Overlay: All Non-stop Corridor Overlay: All Prescribed Watercourses Overlay: All River Murray Flood Plain Overlay: All River Murray Tributaries Area Overlay: All Sloping Land Overlay: All State Heritage Area Overlay: All State Heritage Place Overlay: All State Significant Native Vegetation Overlay: All Strategic Infrastructure (Gas Pipelines) Overlay: All Urban Transport Routes Overlay: All Water Protection Area Overlay: All
Educational establishment	[Land use and intensity]: PO 1.1 [Built form and character]: All	Clearance from Overhead Powerlines: PO 1.1 Design in Urban Areas [All Development]: All	None	Airport Building Heights (Regulated) Overlay: All Aircraft Noise Exposure Overlay: All

Class of Development	Applicable Policies The following policies are applicable to the assessment of the identified Class of Development. Policies referred to are Performance Outcome policies, and any associated Designated Performance Features. Relevant Desired Outcomes are not listed, but automatically apply in relation to a Performance Assessed Development. Where a development comprises more than one Class of Development the relevant policies will be taken to be the sum of the applicable policies for each Class of Development.			
	Zone	General Development Policies	Subzone (applies only in the area affected by the Subzone)	Overlay (applies only in the area affected by the Overlay)
	[Building height and setbacks]: All [Concept Plans]: All	Design in Urban Areas [All Development – 4 or More Building Levels]: All Design in Urban Areas [All Non Residential Development]: All P Interface Between Land Uses [Hours of Operation]: PO 2.1 Interface Between Land Uses [Overshadowing]: PO 3.1, 3.2 Interface Between Land Uses [Activities Generating Noise or Vibration]: PO 4.1, 4.2 Interface Between Land Uses [Light Spill]: PO 6.1, 6.2 Infrastructure and Renewable Energy Facilities [Water Supply]: PO 11.1 Infrastructure and Renewable Energy Facilities [Wastewater Services]: PO 12.1 Transport, Access and Parking [Movement Systems]: All Transport, Access and Parking [Sightlines]: All Transport, Access and Parking [Vehicle Access]: All Transport, Access and Parking [Access to People with Disabilities]: All Transport, Access and Parking [Vehicle Parking Rates]: All Transport, Access and Parking [Vehicle Parking Areas]: All Transport, Access and Parking [Undercroft and Below Ground Garaging and Parking of Vehicles]: All Transport, Access and Parking [Bicycle Parking in Designated Areas]: All		Airport Building Heights (Aircraft Landing Area) Overlay: All Building Near Airfields Overlay: All Character Area Overlay: All Coastal Areas Overlay: All Defence Aviation Area Overlay: All Design Overlay: All Environment and Food Production Area Overlay: All Future Road Widening Overlay: All Hazards (Bushfire – High Risk) Overlay: All Hazards (Bushfire – Medium Risk) Overlay: All Hazards (Bushfire – General Risk) Overlay: All Hazards (Bushfire – Urban Interface) Overlay: All Hazards (Bushfire – Regional) Overlay: All Hazards (Flooding) Overlay: All Historic Area Overlay: All Key Railway Crossings Overlay: All Local Heritage Place Overlay: All Major Urban Transport Routes Overlay: All Marine Parks (Managed Use) Overlay: All Mt Lofty Ranges Catchment (Area 2) Overlay: All Murray Darling Basin Overlay: All Native Vegetation Overlay: All Noise and Air Emissions Overlay: All

Class of Development	Applicable Policies			
	Zone	General Development Policies	Subzone (applies only in the area affected by the Subzone)	Overlay (applies only in the area affected by the Overlay)
				Non-stop Corridor Overlay: All Prescribed Watercourses Overlay: All Prescribed Water Resources Area Overlay: All Prescribed Wells Area Overlay: All Regulated Trees Overlay: All River Murray Flood Plain Overlay: All River Murray Tributaries Area Overlay: All Sloping Land Overlay: All State Heritage Area Overlay: All State Heritage Place Overlay: All State Significant Native Vegetation Overlay: All Strategic Infrastructure (Gas Pipelines) Overlay: All Traffic Generating Development Overlay: All Urban Transport Routes Overlay: All Water Protection Area Overlay: All Water Resources Overlay: All
<u>Emergency services facility</u>	[Land use and intensity]: PO 1.1 [Built form and character]: All [Building height and setbacks]: All [Concept Plans]: All	Clearance from Overhead Powerlines: PO 1.1 Design in Urban Areas [All Development]: All Design in Urban Areas [All Development – 4 or More Building Levels]: All Design in Urban Areas [All Non Residential Development]: All P Interface Between Land Uses [Hours of Operation]: PO 2.1 Interface Between Land Uses [Overshadowing]: PO 3.1, 3.2	None	Airport Building Heights (Regulated) Overlay: All Aircraft Noise Exposure Overlay: All Airport Building Heights (Aircraft Landing Area) Overlay: All Building Near Airfields Overlay: All Character Area Overlay: All Coastal Areas Overlay: All Defence Aviation Area Overlay: All

Class of Development	Applicable Policies The following policies are applicable to the assessment of the identified Class of Development. Policies referred to are Performance Outcome policies, and any associated Designated Performance Features. Relevant Desired Outcomes are not listed, but automatically apply in relation to a Performance Assessed Development. Where a development comprises more than one Class of Development the relevant policies will be taken to be the sum of the applicable policies for each Class of Development.			
	Zone	General Development Policies	Subzone (applies only in the area affected by the Subzone)	Overlay (applies only in the area affected by the Overlay)
		Interface Between Land Uses [Activities Generating Noise or Vibration]: PO 4.1, 4.2 Interface Between Land Uses [Light Spill]: PO 6.1, 6.2 Infrastructure and Renewable Energy Facilities [Water Supply]: PO 11.1 Infrastructure and Renewable Energy Facilities [Wastewater Services]: PO 12.1 Transport, Access and Parking [Movement Systems]: All Transport, Access and Parking [Sightlines]: All Transport, Access and Parking [Vehicle Access]: All Transport, Access and Parking [Access to People with Disabilities]: All Transport, Access and Parking [Vehicle Parking Rates]: All Transport, Access and Parking [Vehicle Parking Areas]: All		Design Overlay: All Environment and Food Production Area Overlay: All Future Road Widening Overlay: All Hazards (Bushfire – High Risk) Overlay: All Hazards (Bushfire – Medium Risk) Overlay: All Hazards (Bushfire – General Risk) Overlay: All Hazards (Bushfire – Urban Interface) Overlay: All Hazards (Bushfire – Regional) Overlay: All Hazards (Flooding) Overlay: All Historic Area Overlay: All Key Railway Crossings Overlay: All Local Heritage Place Overlay: All Major Urban Transport Routes Overlay: All Marine Parks (Managed Use) Overlay: All Mt Lofty Ranges Catchment (Area 2) Overlay: All Murray Darling Basin Overlay: All Native Vegetation Overlay: All Noise and Air Emissions Overlay: All Non-stop Corridor Overlay: All Prescribed Watercourses Overlay: All Prescribed Water Resources Area Overlay: All Prescribed Wells Area Overlay: All Regulated Trees Overlay: All

Class of Development	Applicable Policies			
	Zone	General Development Policies	Subzone (applies only in the area affected by the Subzone)	Overlay (applies only in the area affected by the Overlay)
				River Murray Flood Plain Overlay: All River Murray Tributaries Area Overlay: All Sloping Land Overlay: All State Heritage Area Overlay: All State Heritage Place Overlay: All State Significant Native Vegetation Overlay: All Strategic Infrastructure (Gas Pipelines) Overlay: All Traffic Generating Development Overlay: All Urban Transport Routes Overlay: All Water Protection Area Overlay: All Water Resources Overlay: All
Fence	[Built form and character]: All	Design in Urban Areas [Fences and Walls]: PO 8.1	None	Airport Building Heights (Aircraft Landing Area) Overlay Airport Building Heights (Regulated) Overlay: All Building Near Airfields Overlay: All Character Area Overlay: All Defence Aviation Area Overlay: All Environment and Food Production Area Overlay: All Future Road Widening Overlay: All Historic Area Overlay: All Key Railway Crossings Overlay: All Local Heritage Place Overlay: All Major Urban Transport Routes Overlay: All Marine Parks (Managed Use) Overlay: All Mt Lofty Ranges Catchment (Area 2) Overlay: All Murray Darling Basin Overlay: All Native Vegetation Overlay: All Non-stop Corridor Overlay: All Prescribed Watercourses Overlay: All River Murray Flood Plain Overlay River Murray Tributaries Area Overlay: All State Heritage Area Overlay: All

Class of Development	Applicable Policies			
	Zone	General Development Policies	Subzone (applies only in the area affected by the Subzone)	Overlay (applies only in the area affected by the Overlay)
				State Heritage Place Overlay: All State Significant Native Vegetation Overlay: All Strategic Infrastructure (Gas Pipelines) Overlay: All Urban Transport Routes Overlay: All
Hospital	[Land use and intensity]: PO 1.1 [Built form and character]: All [Building height and setbacks]: All [Concept Plans]: All	Clearance from Overhead Powerlines: PO 1.1 Design in Urban Areas [All Development]: All Design in Urban Areas [All Development – 4 or More Building Levels]: All Design in Urban Areas [All Non Residential Development]: All P Interface Between Land Uses [Hours of Operation]: PO 2.1 Interface Between Land Uses [Overshadowing]: PO 3.1, 3.2 Interface Between Land Uses [Activities Generating Noise or Vibration]: PO 4.1, 4.2 Interface Between Land Uses [Light Spill]: PO 6.1, 6.2 Infrastructure and Renewable Energy Facilities [Water Supply]: PO 11.1 Infrastructure and Renewable Energy Facilities [Wastewater Services]: PO 12.1 Transport, Access and Parking [Movement Systems]: All Transport, Access and Parking [Sightlines]: All Transport, Access and Parking [Vehicle Access]: All Transport, Access and Parking [Access to People with Disabilities]: All Transport, Access and Parking [Vehicle Parking Rates]: All Transport, Access and Parking [Vehicle Parking Areas]: All Transport, Access and Parking [Undercroft and Below Ground Garaging and Parking of Vehicles]: All	None	Airport Building Heights (Regulated) Overlay: All Aircraft Noise Exposure Overlay: All Airport Building Heights (Aircraft Landing Area) Overlay: All Building Near Airfields Overlay: All Character Area Overlay: All Coastal Areas Overlay: All Defence Aviation Area Overlay: All Design Overlay: All Environment and Food Production Area Overlay: All Future Road Widening Overlay: All Hazards (Bushfire – High Risk) Overlay: All Hazards (Bushfire – Medium Risk) Overlay: All Hazards (Bushfire – General Risk) Overlay: All Hazards (Bushfire – Urban Interface) Overlay: All Hazards (Bushfire – Regional) Overlay: All Hazards (Flooding) Overlay: All Historic Area Overlay: All Key Railway Crossings Overlay: All Local Heritage Place Overlay: All Major Urban Transport Routes Overlay: All

Class of Development	Applicable Policies			
	Zone	General Development Policies	Subzone (applies only in the area affected by the Subzone)	Overlay (applies only in the area affected by the Overlay)
		Transport, Access and Parking [Bicycle Parking in Designated Areas]: All		Marine Parks (Managed Use) Overlay: All Mt Lofty Ranges Catchment (Area 2) Overlay: All Murray Darling Basin Overlay: All Native Vegetation Overlay: All Noise and Air Emissions Overlay: All Non-stop Corridor Overlay: All Prescribed Watercourses Overlay: All Prescribed Water Resources Area Overlay: All Prescribed Wells Area Overlay: All Regulated Trees Overlay: All River Murray Flood Plain Overlay: All River Murray Tributaries Area Overlay: All Sloping Land Overlay: All State Heritage Area Overlay: All State Heritage Place Overlay: All State Significant Native Vegetation Overlay: All Strategic Infrastructure (Gas Pipelines) Overlay: All Traffic Generating Development Overlay: All Urban Transport Routes Overlay: All Water Protection Area Overlay: All Water Resources Overlay: All
Hotel	[Land use and intensity]: PO 1.1 [Built form and character]: All	Clearance from Overhead Powerlines: PO 1.1 Design in Urban Areas [All Development]: All	None	Airport Building Heights (Regulated) Overlay: All Aircraft Noise Exposure Overlay: All

Class of Development	Applicable Policies The following policies are applicable to the assessment of the identified Class of Development. Policies referred to are Performance Outcome policies, and any associated Designated Performance Features. Relevant Desired Outcomes are not listed, but automatically apply in relation to a Performance Assessed Development. Where a development comprises more than one Class of Development the relevant policies will be taken to be the sum of the applicable policies for each Class of Development.			
	Zone	General Development Policies	Subzone (applies only in the area affected by the Subzone)	Overlay (applies only in the area affected by the Overlay)
	[Building height and setbacks]: All [Concept Plans]: All	Design in Urban Areas [All Development – 4 or More Building Levels]: All Design in Urban Areas [All Non Residential Development]: All Interface Between Land Uses [Hours of Operation]: PO 2.1 Interface Between Land Uses [Overshadowing]: PO 3.1, 3.2 Interface Between Land Uses [Activities Generating Noise or Vibration]: PO 4.1, 4.2, 4.5, 4.6 Interface Between Lands Uses [Air Quality]: PO 5.2 Interface Between Land Uses [Light Spill]: PO 6.1, 6.2 Infrastructure and Renewable Energy Facilities [Water Supply]: PO 11.1 Infrastructure and Renewable Energy Facilities [Wastewater Services]: PO 12.1 Transport, Access and Parking [Movement Systems]: All Transport, Access and Parking [Sightlines]: All Transport, Access and Parking [Vehicle Access]: All Transport, Access and Parking [Access to People with Disabilities]: All Transport, Access and Parking [Vehicle Parking Rates]: All Transport, Access and Parking [Vehicle Parking Areas]: All Transport, Access and Parking [Undercroft and Below Ground Garaging and Parking of Vehicles]: All Transport, Access and Parking [Bicycle Parking in Designated Areas]: All		Airport Building Heights (Aircraft Landing Area) Overlay: All Building Near Airfields Overlay: All Character Area Overlay: All Coastal Areas Overlay: All Defence Aviation Area Overlay: All Design Overlay: All Environment and Food Production Area Overlay: All Future Road Widening Overlay: All Hazards (Bushfire – High Risk) Overlay: All Hazards (Bushfire – Medium Risk) Overlay: All Hazards (Bushfire – General Risk) Overlay: All Hazards (Bushfire – Urban Interface) Overlay: All Hazards (Bushfire – Regional) Overlay: All Hazards (Flooding) Overlay: All Historic Area Overlay: All Key Railway Crossings Overlay: All Local Heritage Place Overlay: All Major Urban Transport Routes Overlay: All Marine Parks (Managed Use) Overlay: All Mt Lofty Ranges Catchment (Area 2) Overlay: All Murray Darling Basin Overlay: All Native Vegetation Overlay: All Noise and Air Emissions Overlay: All

Class of Development	Applicable Policies			
	Zone	General Development Policies	Subzone (applies only in the area affected by the Subzone)	Overlay (applies only in the area affected by the Overlay)
				<p>Non-stop Corridor Overlay: All</p> <p>Prescribed Watercourses Overlay: All</p> <p>Prescribed Water Resources Area Overlay: All</p> <p>Prescribed Wells Area Overlay: All</p> <p>Regulated Trees Overlay: All</p> <p>River Murray Flood Plain Overlay: All</p> <p>River Murray Tributaries Area Overlay: All</p> <p>Sloping Land Overlay: All</p> <p>State Heritage Area Overlay: All</p> <p>State Heritage Place Overlay: All</p> <p>State Significant Native Vegetation Overlay: All</p> <p>Strategic Infrastructure (Gas Pipelines) Overlay: All</p> <p>Traffic Generating Development Overlay: All</p> <p>Urban Transport Routes Overlay: All</p> <p>Water Protection Area Overlay: All</p> <p>Water Resources Overlay: All</p>
<u>Indoor recreation facility</u>	<p>[Land use and intensity]: PO 1.1</p> <p>[Built form and character]: All</p> <p>[Building height and setbacks]: All</p> <p>[Concept Plans]: All</p>	<p>Clearance from Overhead Powerlines: PO 1.1</p> <p>Design in Urban Areas [All Development]: All</p> <p>Design in Urban Areas [All Development – 4 or More Building Levels]: All</p> <p>Design in Urban Areas [All Non Residential Development]: All</p> <p>Interface Between Land Uses [Hours of Operation]: PO 2.1</p> <p>Interface Between Land Uses [Overshadowing]: PO 3.1, 3.2</p>	None	<p>Airport Building Heights (Regulated) Overlay: All</p> <p>Aircraft Noise Exposure Overlay: All</p> <p>Airport Building Heights (Aircraft Landing Area) Overlay: All</p> <p>Building Near Airfields Overlay: All</p> <p>Character Area Overlay: All</p> <p>Coastal Areas Overlay: All</p> <p>Defence Aviation Area Overlay: All</p>

Class of Development	Applicable Policies The following policies are applicable to the assessment of the identified Class of Development. Policies referred to are Performance Outcome policies, and any associated Designated Performance Features. Relevant Desired Outcomes are not listed, but automatically apply in relation to a Performance Assessed Development. Where a development comprises more than one Class of Development the relevant policies will be taken to be the sum of the applicable policies for each Class of Development.			
	Zone	General Development Policies	Subzone (applies only in the area affected by the Subzone)	Overlay (applies only in the area affected by the Overlay)
		Interface Between Land Uses [Activities Generating Noise or Vibration]: PO 4.1, 4.2, 4.5, 4.6 Interface Between Lands Uses [Air Quality]: PO 5.2 Interface Between Land Uses [Light Spill]: PO 6.1, 6.2 Infrastructure and Renewable Energy Facilities [Water Supply]: PO 11.1 Infrastructure and Renewable Energy Facilities [Wastewater Services]: PO 12.1 Transport, Access and Parking [Movement Systems]: All Transport, Access and Parking [Sightlines]: All Transport, Access and Parking [Vehicle Access]: All Transport, Access and Parking [Access to People with Disabilities]: All Transport, Access and Parking [Vehicle Parking Rates]: All Transport, Access and Parking [Vehicle Parking Areas]: All Transport, Access and Parking [Undercroft and Below Ground Garaging and Parking of Vehicles]: All Transport, Access and Parking [Bicycle Parking in Designated Areas]: All		Design Overlay: All Environment and Food Production Area Overlay: All Future Road Widening Overlay: All Hazards (Bushfire – High Risk) Overlay: All Hazards (Bushfire – Medium Risk) Overlay: All Hazards (Bushfire – General Risk) Overlay: All Hazards (Bushfire – Urban Interface) Overlay: All Hazards (Bushfire – Regional) Overlay: All Hazards (Flooding) Overlay: All Historic Area Overlay: All Key Railway Crossings Overlay: All Local Heritage Place Overlay: All Major Urban Transport Routes Overlay: All Marine Parks (Managed Use) Overlay: All Mt Lofty Ranges Catchment (Area 2) Overlay: All Murray Darling Basin Overlay: All Native Vegetation Overlay: All Noise and Air Emissions Overlay: All Non-stop Corridor Overlay: All Prescribed Watercourses Overlay: All Prescribed Water Resources Area Overlay: All Prescribed Wells Area Overlay: All Regulated Trees Overlay: All

Class of Development	Applicable Policies			
	Zone	General Development Policies	Subzone (applies only in the area affected by the Subzone)	Overlay (applies only in the area affected by the Overlay)
				<p>River Murray Flood Plain Overlay: All</p> <p>River Murray Tributaries Area Overlay: All</p> <p>Sloping Land Overlay: All</p> <p>State Heritage Area Overlay: All</p> <p>State Heritage Place Overlay: All</p> <p>State Significant Native Vegetation Overlay: All</p> <p>Strategic Infrastructure (Gas Pipelines) Overlay: All</p> <p>Traffic Generating Development Overlay: All</p> <p>Urban Transport Routes Overlay: All</p> <p>Water Protection Area Overlay: All</p> <p>Water Resources Overlay: All</p>
Library	<p>[Land use and intensity]: PO 1.1</p> <p>[Built form and character]: All</p> <p>[Building height and setbacks]: All</p> <p>[Concept Plans]: All</p>	<p>Clearance from Overhead Powerlines: PO 1.1</p> <p>Design in Urban Areas [All Development]: All</p> <p>Design in Urban Areas [All Development – 4 or More Building Levels]: All</p> <p>Design in Urban Areas [All Non Residential Development]: All P</p> <p>Interface Between Land Uses [Hours of Operation]: PO 2.1</p> <p>Interface Between Land Uses [Overshadowing]: PO 3.1, 3.2</p> <p>Interface Between Land Uses [Activities Generating Noise or Vibration]: PO 4.1, 4.2</p> <p>Interface Between Land Uses [Light Spill]: PO 6.1, 6.2</p> <p>Infrastructure and Renewable Energy Facilities [Water Supply]: PO 11.1</p> <p>Infrastructure and Renewable Energy Facilities [Wastewater Services]: PO 12.1</p>	None	<p>Airport Building Heights (Regulated) Overlay: All</p> <p>Aircraft Noise Exposure Overlay: All</p> <p>Airport Building Heights (Aircraft Landing Area) Overlay: All</p> <p>Building Near Airfields Overlay: All</p> <p>Character Area Overlay: All</p> <p>Coastal Areas Overlay: All</p> <p>Defence Aviation Area Overlay: All</p> <p>Design Overlay: All</p> <p>Environment and Food Production Area Overlay: All</p> <p>Future Road Widening Overlay: All</p> <p>Hazards (Bushfire – High Risk) Overlay: All</p> <p>Hazards (Bushfire – Medium Risk) Overlay: All</p>

Class of Development	Applicable Policies			
	Zone	General Development Policies	Subzone (applies only in the area affected by the Subzone)	Overlay (applies only in the area affected by the Overlay)
		Transport, Access and Parking [Movement Systems]: All Transport, Access and Parking [Sightlines]: All Transport, Access and Parking [Vehicle Access]: All Transport, Access and Parking [Access to People with Disabilities]: All Transport, Access and Parking [Vehicle Parking Rates]: All Transport, Access and Parking [Vehicle Parking Areas]: All Transport, Access and Parking [Undercroft and Below Ground Garaging and Parking of Vehicles]: All Transport, Access and Parking [Bicycle Parking in Designated Areas]: All		Hazards (Bushfire – General Risk) Overlay: All Hazards (Bushfire – Urban Interface) Overlay: All Hazards (Bushfire – Regional) Overlay: All Hazards (Flooding) Overlay: All Historic Area Overlay: All Key Railway Crossings Overlay: All Local Heritage Place Overlay: All Major Urban Transport Routes Overlay: All Marine Parks (Managed Use) Overlay: All Mt Lofty Ranges Catchment (Area 2) Overlay: All Murray Darling Basin Overlay: All Native Vegetation Overlay: All Noise and Air Emissions Overlay: All Non-stop Corridor Overlay: All Prescribed Watercourses Overlay: All Prescribed Water Resources Area Overlay: All Prescribed Wells Area Overlay: All Regulated Trees Overlay: All River Murray Flood Plain Overlay: All River Murray Tributaries Area Overlay: All Sloping Land Overlay: All State Heritage Area Overlay: All State Heritage Place Overlay: All

Class of Development	Applicable Policies			
	Zone	General Development Policies	Subzone (applies only in the area affected by the Subzone)	Overlay (applies only in the area affected by the Overlay)
				State Significant Native Vegetation Overlay: All Strategic Infrastructure (Gas Pipelines) Overlay: All Traffic Generating Development Overlay: All Urban Transport Routes Overlay: All Water Protection Area Overlay: All Water Resources Overlay: All
Land division	[Land Division]: PO 4.1	Land Division in Urban Areas: All	None	Affordable Housing Overlay: All Character Area Overlay: All Coastal Areas Overlay: All Environment and Food Production Area Overlay: All Hazards (Bushfire – High Risk) Overlay: All Hazards (Bushfire – Medium Risk) Overlay : All Hazards (Bushfire – General Risk) Overlay : All Hazards (Bushfire – Urban Interface) Overlay: All Hazards (Bushfire – Regional) Overlay: All Hazards (Flooding) Overlay: All Historic Area Overlay: All Key Railway Crossings Overlay: All Local Heritage Place Overlay: All Major Urban Transport Routes Overlay: All Marine Parks (Managed Use) Overlay: All Mt Lofty Ranges Catchment (Area 2) Overlay: All Murray Darling Basin Overlay: All

Class of Development	Applicable Policies			
	Zone	General Development Policies	Subzone (applies only in the area affected by the Subzone)	Overlay (applies only in the area affected by the Overlay)
				Native Vegetation Overlay: All Noise and Air Emissions Overlay: All Non-stop Corridor Overlay: All Prescribed Watercourses Overlay: All Prescribed Water Resources Area Overlay: All Prescribed Wells Area Overlay: All River Murray Flood Plain Overlay: All River Murray Tributaries Area Overlay: All Sloping Land Overlay: All State Heritage Area Overlay: All State Heritage Place Overlay: All State Significant Native Vegetation Overlay: All Strategic Infrastructure (Gas Pipelines) Overlay: All Traffic Generating Development Overlay: All Urban Transport Routes Overlay: All Water Protection Area Overlay: All Water Resources Overlay: All
Office Bank Civic centre	[Land use and intensity]: PO 1.1 [Built form and character]: All [Building height and setbacks]: All [Concept Plans]: All	Clearance from Overhead Powerlines: PO 1.1 Design in Urban Areas [All Development]: All Design in Urban Areas [All Development – 4 or More Building Levels]: All Design in Urban Areas [All Non Residential Development]: All P Interface Between Land Uses [Hours of Operation]: PO 2.1 Interface Between Land Uses [Overshadowing]: PO 3.1, 3.2	None	Airport Building Heights (Regulated) Overlay: All Aircraft Noise Exposure Overlay: All Airport Building Heights (Aircraft Landing Area) Overlay: All Building Near Airfields Overlay: All Character Area Overlay: All Coastal Areas Overlay: All

Class of Development	Applicable Policies The following policies are applicable to the assessment of the identified Class of Development. Policies referred to are Performance Outcome policies, and any associated Designated Performance Features. Relevant Desired Outcomes are not listed, but automatically apply in relation to a Performance Assessed Development. Where a development comprises more than one Class of Development the relevant policies will be taken to be the sum of the applicable policies for each Class of Development.			
	Zone	General Development Policies	Subzone (applies only in the area affected by the Subzone)	Overlay (applies only in the area affected by the Overlay)
		Interface Between Land Uses [Activities Generating Noise or Vibration]: PO 4.1, 4.2 Interface Between Land Uses [Light Spill]: PO 6.1, 6.2 Infrastructure and Renewable Energy Facilities [Water Supply]: PO 11.1 Infrastructure and Renewable Energy Facilities [Wastewater Services]: PO 12.1 Transport, Access and Parking [Movement Systems]: All Transport, Access and Parking [Sightlines]: All Transport, Access and Parking [Vehicle Access]: All Transport, Access and Parking [Access to People with Disabilities]: All Transport, Access and Parking [Vehicle Parking Rates]: All Transport, Access and Parking [Vehicle Parking Areas]: All Transport, Access and Parking [Undercroft and Below Ground Garaging and Parking of Vehicles]: All Transport, Access and Parking [Bicycle Parking in Designated Areas]: All		Defence Aviation Area Overlay: All Design Overlay: All Environment and Food Production Area Overlay: All Future Road Widening Overlay: All Hazards (Bushfire – High Risk) Overlay: All Hazards (Bushfire – Medium Risk) Overlay: All Hazards (Bushfire – General Risk) Overlay: All Hazards (Bushfire – Urban Interface) Overlay: All Hazards (Bushfire – Regional) Overlay: All Hazards (Flooding) Overlay: All Historic Area Overlay: All Key Railway Crossings Overlay: All Local Heritage Place Overlay: All Major Urban Transport Routes Overlay: All Marine Parks (Managed Use) Overlay: All Mt Lofty Ranges Catchment (Area 2) Overlay: All Murray Darling Basin Overlay: All Native Vegetation Overlay: All Noise and Air Emissions Overlay: All Non-stop Corridor Overlay: All Prescribed Watercourses Overlay: All Prescribed Water Resources Area Overlay: All Prescribed Wells Area Overlay: All

Class of Development	Applicable Policies			
	Zone	General Development Policies	Subzone (applies only in the area affected by the Subzone)	Overlay (applies only in the area affected by the Overlay)
				Regulated Trees Overlay: All River Murray Flood Plain Overlay: All River Murray Tributaries Area Overlay: All Sloping Land Overlay: All State Heritage Area Overlay: All State Heritage Place Overlay: All State Significant Native Vegetation Overlay: All Strategic Infrastructure (Gas Pipelines) Overlay: All Traffic Generating Development Overlay: All Urban Transport Routes Overlay: All Water Protection Area Overlay: All Water Resources Overlay: All
<u>Outbuilding Store</u>	[Land use and intensity]: PO 1.1 [Built form and character]: All [Building height and setbacks]: All [Concept Plans]: All	None	None	Airport Building Heights (Regulated) Overlay: All Airport Building Heights (Aircraft Landing Area) Overlay: All Building Near Airfields Overlay: All Character Area Overlay: All Defence Aviation Area Overlay: All Future Road Widening Overlay: All Historic Area Overlay: All Key Railway Crossings Overlay: All Local Heritage Place Overlay: All Major Urban Transport Routes Overlay: All Mt Lofty Ranges Catchment (Area 2) Overlay: All

Class of Development	Applicable Policies			
	Zone	General Development Policies	Subzone (applies only in the area affected by the Subzone)	Overlay (applies only in the area affected by the Overlay)
				Marine Parks (Managed Use) Overlay: All Murray Darling Basin Overlay: All Native Vegetation Overlay: All Non-stop Corridor Overlay: All River Murray Flood Plain Overlay: All River Murray Tributaries Area Overlay: All State Heritage Area Overlay: All State Heritage Place Overlay: All State Significant Native Vegetation Overlay: All Strategic Infrastructure (Gas Pipelines) Overlay: All Urban Transport Routes Overlay: All
Place of worship	[Land use and intensity]: PO 1.1 [Built form and character]: All [Building height and setbacks]: All [Concept Plans]: All	Clearance from Overhead Powerlines: PO 1.1 Design in Urban Areas [All Development]: All Design in Urban Areas [All Development – 4 or More Building Levels]: All Design in Urban Areas [All Non Residential Development]: All P Interface Between Land Uses [Hours of Operation]: PO 2.1 Interface Between Land Uses [Overshadowing]: PO 3.1, 3.2 Interface Between Land Uses [Activities Generating Noise or Vibration]: PO 4.1, 4.2 Interface Between Land Uses [Light Spill]: PO 6.1, 6.2 Infrastructure and Renewable Energy Facilities [Water Supply]: PO 11.1	None	Airport Building Heights (Regulated) Overlay: All Aircraft Noise Exposure Overlay: All Airport Building Heights (Aircraft Landing Area) Overlay: All Building Near Airfields Overlay: All Character Area Overlay: All Coastal Areas Overlay: All Defence Aviation Area Overlay: All Design Overlay: All Environment and Food Production Area Overlay: All Future Road Widening Overlay: All Hazards (Bushfire – High Risk) Overlay: All Hazards (Bushfire – Medium Risk) Overlay: All

Class of Development	Applicable Policies The following policies are applicable to the assessment of the identified Class of Development. Policies referred to are Performance Outcome policies, and any associated Designated Performance Features. Relevant Desired Outcomes are not listed, but automatically apply in relation to a Performance Assessed Development. Where a development comprises more than one Class of Development the relevant policies will be taken to be the sum of the applicable policies for each Class of Development.			
	Zone	General Development Policies	Subzone (applies only in the area affected by the Subzone)	Overlay (applies only in the area affected by the Overlay)
		Infrastructure and Renewable Energy Facilities [Wastewater Services]: PO 12.1 Transport, Access and Parking [Movement Systems]: All Transport, Access and Parking [Sightlines]: All Transport, Access and Parking [Vehicle Access]: All Transport, Access and Parking [Access to People with Disabilities]: All Transport, Access and Parking [Vehicle Parking Rates]: All Transport, Access and Parking [Vehicle Parking Areas]: All Transport, Access and Parking [Undercroft and Below Ground Garaging and Parking of Vehicles]: All Transport, Access and Parking [Bicycle Parking in Designated Areas]: All		Hazards (Bushfire – General Risk) Overlay: All Hazards (Bushfire – Urban Interface) Overlay: All Hazards (Bushfire – Regional) Overlay: All Hazards (Flooding) Overlay: All Historic Area Overlay: All Key Railway Crossings Overlay: All Local Heritage Place Overlay: All Major Urban Transport Routes Overlay: All Marine Parks (Managed Use) Overlay: All Mt Lofty Ranges Catchment (Area 2) Overlay: All Murray Darling Basin Overlay: All Native Vegetation Overlay: All Noise and Air Emissions Overlay: All Non-stop Corridor Overlay: All Prescribed Watercourses Overlay: All Prescribed Water Resources Area Overlay: All Prescribed Wells Area Overlay: All Regulated Trees Overlay: All River Murray Flood Plain Overlay: All River Murray Tributaries Area Overlay: All Sloping Land Overlay: All State Heritage Area Overlay: All State Heritage Place Overlay: All

Class of Development	Applicable Policies			
	Zone	General Development Policies	Subzone (applies only in the area affected by the Subzone)	Overlay (applies only in the area affected by the Overlay)
				State Significant Native Vegetation Overlay: All Strategic Infrastructure (Gas Pipelines) Overlay: All Traffic Generating Development Overlay: All Urban Transport Routes Overlay: All Water Protection Area Overlay: All Water Resources Overlay: All
Pre-school	[Land use and intensity]: PO 1.1 [Built form and character]: All [Building height and setbacks]: All [Concept Plans]: All	Clearance from Overhead Powerlines: PO 1.1 Design in Urban Areas [All Development]: All Design in Urban Areas [All Development – 4 or More Building Levels]: All Design in Urban Areas [All Non Residential Development]: All P Interface Between Land Uses [Hours of Operation]: PO 2.1 Interface Between Land Uses [Overshadowing]: PO 3.1, 3.2 Interface Between Land Uses [Activities Generating Noise or Vibration]: PO 4.1, 4.2 Interface Between Land Uses [Light Spill]: PO 6.1, 6.2 Infrastructure and Renewable Energy Facilities [Water Supply]: PO 11.1 Infrastructure and Renewable Energy Facilities [Wastewater Services]: PO 12.1 Transport, Access and Parking [Movement Systems]: All Transport, Access and Parking [Sightlines]: All Transport, Access and Parking [Vehicle Access]: All Transport, Access and Parking [Access to People with Disabilities]: All	None	Airport Building Heights (Regulated) Overlay: All Aircraft Noise Exposure Overlay: All Airport Building Heights (Aircraft Landing Area) Overlay: All Building Near Airfields Overlay: All Character Area Overlay: All Coastal Areas Overlay: All Defence Aviation Area Overlay: All Design Overlay: All Environment and Food Production Area Overlay: All Future Road Widening Overlay: All Hazards (Bushfire – High Risk) Overlay: All Hazards (Bushfire – Medium Risk) Overlay: All Hazards (Bushfire – General Risk) Overlay: All Hazards (Bushfire – Urban Interface) Overlay: All Hazards (Bushfire – Regional) Overlay: All Hazards (Flooding) Overlay: All Historic Area Overlay: All

Class of Development	Applicable Policies The following policies are applicable to the assessment of the identified Class of Development. Policies referred to are Performance Outcome policies, and any associated Designated Performance Features. Relevant Desired Outcomes are not listed, but automatically apply in relation to a Performance Assessed Development. Where a development comprises more than one Class of Development the relevant policies will be taken to be the sum of the applicable policies for each Class of Development.			
	Zone	General Development Policies	Subzone (applies only in the area affected by the Subzone)	Overlay (applies only in the area affected by the Overlay)
		Transport, Access and Parking [Vehicle Parking Rates]: All Transport, Access and Parking [Vehicle Parking Areas]: All Transport, Access and Parking [Undercroft and Below Ground Garaging and Parking of Vehicles]: All Transport, Access and Parking [Bicycle Parking in Designated Areas]: All		Key Railway Crossings Overlay: All Local Heritage Place Overlay: All Major Urban Transport Routes Overlay: All Marine Parks (Managed Use) Overlay: All Mt Lofty Ranges Catchment (Area 2) Overlay: All Murray Darling Basin Overlay: All Native Vegetation Overlay: All Noise and Air Emissions Overlay: All Non-stop Corridor Overlay: All Prescribed Watercourses Overlay: All Prescribed Water Resources Area Overlay: All Prescribed Wells Area Overlay: All Regulated Trees Overlay: All River Murray Flood Plain Overlay: All River Murray Tributaries Area Overlay: All Sloping Land Overlay: All State Heritage Area Overlay: All State Heritage Place Overlay: All State Significant Native Vegetation Overlay: All Strategic Infrastructure (Gas Pipelines) Overlay: All Traffic Generating Development Overlay: All Urban Transport Routes Overlay: All Water Protection Area Overlay: All

Class of Development	Applicable Policies			
	Zone	General Development Policies	Subzone (applies only in the area affected by the Subzone)	Overlay (applies only in the area affected by the Overlay)
				Water Resources Overlay: All
<u>Public transport terminal</u>	[Land use and intensity]: PO 1.1 [Built form and character]: All [Building height and setbacks]: All [Concept Plans]: All	Clearance from Overhead Powerlines: PO 1.1 Design in Urban Areas [All Development]: All Design in Urban Areas [All Development – 4 or More Building Levels]: All Design in Urban Areas [All Non Residential Development]: All PO Interface Between Land Uses [Hours of Operation]: PO 2.1 Interface Between Land Uses [Overshadowing]: PO 3.1, 3.2 Interface Between Land Uses [Activities Generating Noise or Vibration]: PO 4.1, 4.2 Interface Between Land Uses [Light Spill]: PO 6.1, 6.2 Infrastructure and Renewable Energy Facilities [Water Supply]: PO 11.1 Infrastructure and Renewable Energy Facilities [Wastewater Services]: PO 12.1 Transport, Access and Parking [Movement Systems]: All Transport, Access and Parking [Sightlines]: All Transport, Access and Parking [Vehicle Access]: All Transport, Access and Parking [Access to People with Disabilities]: All Transport, Access and Parking [Vehicle Parking Rates]: All Transport, Access and Parking [Vehicle Parking Areas]: All Transport, Access and Parking [Undercroft and Below Ground Garaging and Parking of Vehicles]: All	None	Water Resources Overlay: All Airport Building Heights (Regulated) Overlay: All Aircraft Noise Exposure Overlay: All Airport Building Heights (Aircraft Landing Area) Overlay: All Building Near Airfields Overlay: All Character Area Overlay: All Coastal Areas Overlay: All Defence Aviation Area Overlay: All Design Overlay: All Environment and Food Production Area Overlay: All Future Road Widening Overlay: All Hazards (Bushfire – High Risk) Overlay: All Hazards (Bushfire – Medium Risk) Overlay: All Hazards (Bushfire – General Risk) Overlay: All Hazards (Bushfire – Urban Interface) Overlay: All Hazards (Bushfire – Regional) Overlay: All Hazards (Flooding) Overlay: All Historic Area Overlay: All Key Railway Crossings Overlay: All Local Heritage Place Overlay: All Major Urban Transport Routes Overlay: All Marine Parks (Managed Use) Overlay: All Mt Lofty Ranges Catchment (Area 2) Overlay: All

Class of Development	Applicable Policies			
	Zone	General Development Policies	Subzone (applies only in the area affected by the Subzone)	Overlay (applies only in the area affected by the Overlay)
		Transport, Access and Parking [Bicycle Parking in Designated Areas]: All		Murray Darling Basin Overlay: All Native Vegetation Overlay: All Noise and Air Emissions Overlay: All Non-stop Corridor Overlay: All Prescribed Watercourses Overlay: All Prescribed Water Resources Area Overlay: All Prescribed Wells Area Overlay: All Regulated Trees Overlay: All River Murray Flood Plain Overlay: All River Murray Tributaries Area Overlay: All Sloping Land Overlay: All State Heritage Area Overlay: All State Heritage Place Overlay: All State Significant Native Vegetation Overlay: All Strategic Infrastructure (Gas Pipelines) Overlay: All Traffic Generating Development Overlay: All Urban Transport Routes Overlay: All Water Protection Area Overlay: All Water Resources Overlay: All
Recreation area	[Land use and intensity]: PO 1.1 [Built form and character]: All [Concept Plans]: All	Open Space and Recreation: All Transport, Access and Parking [Movement Systems]: All Transport, Access and Parking [Sightlines]: All Transport, Access and Parking [Vehicle Access]: All	None	Character Area Overlay: All Coastal Areas Overlay: All Future Road Widening Overlay: All Hazards (Bushfire – High Risk) Overlay: All

Class of Development	Applicable Policies The following policies are applicable to the assessment of the identified Class of Development. Policies referred to are Performance Outcome policies, and any associated Designated Performance Features. Relevant Desired Outcomes are not listed, but automatically apply in relation to a Performance Assessed Development. Where a development comprises more than one Class of Development the relevant policies will be taken to be the sum of the applicable policies for each Class of Development.			
	Zone	General Development Policies	Subzone (applies only in the area affected by the Subzone)	Overlay (applies only in the area affected by the Overlay)
		Transport, Access and Parking [Access to People with Disabilities]: All Transport, Access and Parking [Vehicle Parking Rates]: All Transport, Access and Parking [Vehicle Parking Areas]: All Transport, Access and Parking [Undercroft and Below Ground Garaging and Parking of Vehicles]: All Transport, Access and Parking [Bicycle Parking in Designated Areas]: All		Hazards (Bushfire – Medium Risk) Overlay: All Hazards (Bushfire – General Risk) Overlay: All Hazards (Bushfire – Regional) Overlay Hazards (Bushfire – Urban Interface) Overlay: All Historic Area Overlay: All Local Heritage Place Overlay: All Major Urban Transport Routes Overlay: All Marine Parks (Managed Use) Overlay: All Mt Lofty Ranges Catchment (Area 2) Overlay: All Murray Darling Basin Overlay: All Native Vegetation Overlay: All Non-stop Corridor Overlay: All Prescribed Watercourses Overlay: All Prescribed Water Resources Area Overlay: All Prescribed Wells Area Overlay: All River Murray Flood Plain Overlay River Murray Tributaries Area Overlay: All Sloping Land Overlay: All State Heritage Area Overlay: All State Heritage Place Overlay: All State Significant Native Vegetation Overlay: All Strategic Infrastructure (Gas Pipelines) Overlay: All Traffic Generating Development Overlay: All

Class of Development	Applicable Policies			
	Zone	General Development Policies	Subzone (applies only in the area affected by the Subzone)	Overlay (applies only in the area affected by the Overlay)
				Urban Transport Routes Overlay: All Water Protection Area Overlay: All Water Resources Overlay: All
<u>Retail fuel outlet</u>	[Land use and intensity]: PO 1.1 [Built form and character]: All [Building height and setbacks]: All [Concept Plans]: All	Clearance from Overhead Powerlines: PO 1.1 Design in Urban Areas [All Development]: All Design in Urban Areas [All Development – 4 or More Building Levels]: All Design in Urban Areas [All Non Residential Development]: All Interface Between Land Uses [Hours of Operation]: PO 2.1 Interface Between Land Uses [Overshadowing]: PO 3.1, 3.2 Interface Between Land Uses [Activities Generating Noise or Vibration]: PO 4.1, 4.2 Interface Between Land Uses [Light Spill]: PO 6.1, 6.2 Infrastructure and Renewable Energy Facilities [Water Supply]: PO 11.1 Infrastructure and Renewable Energy Facilities [Wastewater Services]: PO 12.1 Transport, Access and Parking [Movement Systems]: All Transport, Access and Parking [Sightlines]: All Transport, Access and Parking [Vehicle Access]: All Transport, Access and Parking [Access to People with Disabilities]: All Transport, Access and Parking [Vehicle Parking Rates]: All Transport, Access and Parking [Vehicle Parking Areas]: All	None	Airport Building Heights (Regulated) Overlay: All Aircraft Noise Exposure Overlay: All Airport Building Heights (Aircraft Landing Area) Overlay: All Building Near Airfields Overlay: All Character Area Overlay: All Coastal Areas Overlay: All Defence Aviation Area Overlay: All Design Overlay: All Environment and Food Production Area Overlay: All Future Road Widening Overlay: All Hazards (Bushfire – High Risk) Overlay: All Hazards (Bushfire – Medium Risk) Overlay: All Hazards (Bushfire – General Risk) Overlay: All Hazards (Bushfire – Urban Interface) Overlay: All Hazards (Bushfire – Regional) Overlay: All Hazards (Flooding) Overlay: All Historic Area Overlay: All Key Railway Crossings Overlay: All Local Heritage Place Overlay: All Major Urban Transport Routes Overlay: All

Class of Development	Applicable Policies			
	Zone	General Development Policies	Subzone (applies only in the area affected by the Subzone)	Overlay (applies only in the area affected by the Overlay)
		Transport, Access and Parking [Undercroft and Below Ground Garaging and Parking of Vehicles]: All Transport, Access and Parking [Bicycle Parking in Designated Areas]: All		Marine Parks (Managed Use) Overlay: All Mt Lofty Ranges Catchment (Area 2) Overlay: All Murray Darling Basin Overlay: All Native Vegetation Overlay: All Noise and Air Emissions Overlay: All Non-stop Corridor Overlay: All Prescribed Watercourses Overlay: All Prescribed Water Resources Area Overlay: All Prescribed Wells Area Overlay: All Regulated Trees Overlay: All River Murray Flood Plain Overlay: All River Murray Tributaries Area Overlay: All Sloping Land Overlay: All State Heritage Area Overlay: All State Heritage Place Overlay: All State Significant Native Vegetation Overlay: All Strategic Infrastructure (Gas Pipelines) Overlay: All Traffic Generating Development Overlay: All Urban Transport Routes Overlay: All Water Protection Area Overlay: All Water Resources Overlay: All
Restaurant	[Land use and intensity]: PO 1.1 [Built form and character]: All	Clearance from Overhead Powerlines: PO 1.1 Design in Urban Areas [All Development]: All	None	Airport Building Heights (Regulated) Overlay: All Aircraft Noise Exposure Overlay: All

Class of Development	Applicable Policies The following policies are applicable to the assessment of the identified Class of Development. Policies referred to are Performance Outcome policies, and any associated Designated Performance Features. Relevant Desired Outcomes are not listed, but automatically apply in relation to a Performance Assessed Development. Where a development comprises more than one Class of Development the relevant policies will be taken to be the sum of the applicable policies for each Class of Development.			
	Zone	General Development Policies	Subzone (applies only in the area affected by the Subzone)	Overlay (applies only in the area affected by the Overlay)
	[Building height and setbacks]: All [Concept Plans]: All	Design in Urban Areas [All Development – 4 or More Building Levels]: All Design in Urban Areas [All Non Residential Development]: All Interface Between Land Uses [Hours of Operation]: PO 2.1 Interface Between Land Uses [Overshadowing]: PO 3.1, 3.2 Interface Between Land Uses [Activities Generating Noise or Vibration]: PO 4.1, 4.2 Interface Between Lands Uses [Air Quality]: PO 5.2 Interface Between Land Uses [Light Spill]: PO 6.1, 6.2 Infrastructure and Renewable Energy Facilities [Water Supply]: PO 11.1 Infrastructure and Renewable Energy Facilities [Wastewater Services]: PO 12.1 Transport, Access and Parking [Movement Systems]: All Transport, Access and Parking [Sightlines]: All Transport, Access and Parking [Vehicle Access]: All Transport, Access and Parking [Access to People with Disabilities]: All Transport, Access and Parking [Vehicle Parking Rates]: All Transport, Access and Parking [Vehicle Parking Areas]: All Transport, Access and Parking [Undercroft and Below Ground Garaging and Parking of Vehicles]: All Transport, Access and Parking [Bicycle Parking in Designated Areas]: All		Airport Building Heights (Aircraft Landing Area) Overlay: All Building Near Airfields Overlay: All Character Area Overlay: All Coastal Areas Overlay: All Defence Aviation Area Overlay: All Design Overlay: All Environment and Food Production Area Overlay: All Future Road Widening Overlay: All Hazards (Bushfire – High Risk) Overlay: All Hazards (Bushfire – Medium Risk) Overlay: All Hazards (Bushfire – General Risk) Overlay: All Hazards (Bushfire – Urban Interface) Overlay: All Hazards (Bushfire – Regional) Overlay: All Hazards (Flooding) Overlay: All Historic Area Overlay: All Key Railway Crossings Overlay: All Local Heritage Place Overlay: All Major Urban Transport Routes Overlay: All Marine Parks (Managed Use) Overlay: All Mt Lofty Ranges Catchment (Area 2) Overlay: All Murray Darling Basin Overlay: All Native Vegetation Overlay: All Noise and Air Emissions Overlay: All

Class of Development	Applicable Policies			
	Zone	General Development Policies	Subzone (applies only in the area affected by the Subzone)	Overlay (applies only in the area affected by the Overlay)
				<p>Non-stop Corridor Overlay: All</p> <p>Prescribed Watercourses Overlay: All</p> <p>Prescribed Water Resources Area Overlay: All</p> <p>Prescribed Wells Area Overlay: All</p> <p>Regulated Trees Overlay: All</p> <p>River Murray Flood Plain Overlay: All</p> <p>River Murray Tributaries Area Overlay: All</p> <p>Sloping Land Overlay: All</p> <p>State Heritage Area Overlay: All</p> <p>State Heritage Place Overlay: All</p> <p>State Significant Native Vegetation Overlay: All</p> <p>Strategic Infrastructure (Gas Pipelines) Overlay: All</p> <p>Traffic Generating Development Overlay: All</p> <p>Urban Transport Routes Overlay: All</p> <p>Water Protection Area Overlay: All</p> <p>Water Resources Overlay: All</p>
Retaining wall	[Built form and character]: All	Design in Urban Areas [All Development – Fences and Walls]: All	None	<p>Character Area Overlay: All</p> <p>Defence Aviation Area Overlay: All</p> <p>Environment and Food Production Area Overlay: All</p> <p>Future Road Widening Overlay: All</p> <p>Historic Area Overlay: All</p> <p>Key Railway Crossings Overlay: All</p> <p>Local Heritage Place Overlay: All</p> <p>Major Urban Transport Routes Overlay: All</p>

Class of Development	Applicable Policies			
	Zone	General Development Policies	Subzone (applies only in the area affected by the Subzone)	Overlay (applies only in the area affected by the Overlay)
				Marine Parks (Managed Use) Overlay: All Mt Lofty Ranges Catchment (Area 2) Overlay: All Murray Darling Basin Overlay: All Native Vegetation Overlay: All Non-stop Corridor Overlay: All Prescribed Watercourses Overlay: All River Murray Flood Plain Overlay: All River Murray Tributaries Area Overlay: All State Heritage Area Overlay: All State Heritage Place Overlay: All State Significant Native Vegetation Overlay: All Strategic Infrastructure (Gas Pipelines) Overlay: All Urban Transport Routes Overlay: All
Shop (not being a restaurant or bulky goods outlet)	[Land use and intensity]: PO 1.1 [Built form and character]: All [Building height and setbacks]: All [Concept Plans]: All	Clearance from Overhead Powerlines: PO 1.1 Design in Urban Areas [All Development]: All Design in Urban Areas [All Development – 4 or More Building Levels]: All Design in Urban Areas [All Non Residential Development]: All Interface Between Land Uses [Hours of Operation]: PO 2.1 Interface Between Land Uses [Overshadowing]: PO 3.1, 3.2 Interface Between Land Uses [Activities Generating Noise or Vibration]: PO 4.1, 4.2 Interface Between Land Uses [Light Spill]: PO 6.1, 6.2 Infrastructure and Renewable Energy Facilities [Water Supply]: PO 11.1	None	Airport Building Heights (Regulated) Overlay: All Aircraft Noise Exposure Overlay: All Airport Building Heights (Aircraft Landing Area) Overlay: All Building Near Airfields Overlay: All Character Area Overlay: All Coastal Areas Overlay: All Defence Aviation Area Overlay: All Design Overlay: All Environment and Food Production Area Overlay: All Future Road Widening Overlay: All Hazards (Bushfire – High Risk) Overlay: All

Class of Development	Applicable Policies The following policies are applicable to the assessment of the identified Class of Development. Policies referred to are Performance Outcome policies, and any associated Designated Performance Features. Relevant Desired Outcomes are not listed, but automatically apply in relation to a Performance Assessed Development. Where a development comprises more than one Class of Development the relevant policies will be taken to be the sum of the applicable policies for each Class of Development.			
	Zone	General Development Policies	Subzone (applies only in the area affected by the Subzone)	Overlay (applies only in the area affected by the Overlay)
		Infrastructure and Renewable Energy Facilities [Wastewater Services]: PO 12.1 Transport, Access and Parking [Movement Systems]: All Transport, Access and Parking [Sightlines]: All Transport, Access and Parking [Vehicle Access]: All Transport, Access and Parking [Access to People with Disabilities]: All Transport, Access and Parking [Vehicle Parking Rates]: All Transport, Access and Parking [Vehicle Parking Areas]: All Transport, Access and Parking [Undercroft and Below Ground Garaging and Parking of Vehicles]: All Transport, Access and Parking [Bicycle Parking in Designated Areas]: All		Hazards (Bushfire – Medium Risk) Overlay: All Hazards (Bushfire – General Risk) Overlay: All Hazards (Bushfire – Urban Interface) Overlay: All Hazards (Bushfire – Regional) Overlay: All Hazards (Flooding) Overlay: All Historic Area Overlay: All Key Railway Crossings Overlay: All Local Heritage Place Overlay: All Major Urban Transport Routes Overlay: All Marine Parks (Managed Use) Overlay: All Mt Lofty Ranges Catchment (Area 2) Overlay: All Murray Darling Basin Overlay: All Native Vegetation Overlay: All Noise and Air Emissions Overlay: All Non-stop Corridor Overlay: All Prescribed Watercourses Overlay: All Prescribed Water Resources Area Overlay: All Prescribed Wells Area Overlay: All Regulated Trees Overlay: All River Murray Flood Plain Overlay: All River Murray Tributaries Area Overlay: All Sloping Land Overlay: All State Heritage Area Overlay: All State Heritage Place Overlay: All

Class of Development	Applicable Policies			
	Zone	General Development Policies	Subzone (applies only in the area affected by the Subzone)	Overlay (applies only in the area affected by the Overlay)
				State Significant Native Vegetation Overlay: All Strategic Infrastructure (Gas Pipelines) Overlay: All Traffic Generating Development Overlay: All Urban Transport Routes Overlay: All Water Protection Area Overlay: All Water Resources Overlay: All
<u>Telecommunications facility</u>	[Built form and character]: All	Infrastructure and Renewable Energy Facilities [General]: All Infrastructure and Renewable Energy Facilities [Visual Amenity]: All Infrastructure and Renewable Energy Facilities [Telecommunication Facilities]: All	None	Airport Building Heights (Aircraft Landing Area) Overlay: All Airport Building Heights (Regulated) Overlay: All Building Near Airfields Overlay: All Character Area Overlay: All Defence Aviation Area Overlay: All Future Road Widening Overlay: All Historic Area Overlay: All Local Heritage Place Overlay: All Major Urban Transport Routes Overlay: All Murray Darling Basin Overlay: All Native Vegetation Overlay: All State Heritage Area Overlay: All State Heritage Place Overlay: All State Significant Native Vegetation Overlay: All Strategic Infrastructure (Gas Pipelines) Overlay: All
Tree-damaging activity	None	None	None	Regulated Tree Overlay: All
Verandah Shade sail	[Built form and character]: All	None	None	Airport Building Heights (Regulated) Overlay: All Airport Building Heights (Aircraft Landing Area) Overlay: All

Class of Development	Applicable Policies			
	Zone	General Development Policies	Subzone (applies only in the area affected by the Subzone)	Overlay (applies only in the area affected by the Overlay)
				Building Near Airfields Overlay: All Character Area Overlay: All Defence Aviation Area Overlay: All Future Road Widening Overlay: All Historic Area Overlay: All Key Railway Crossings Overlay: All Local Heritage Place Overlay: All Major Urban Transport Routes Overlay: All Mt Lofty Ranges Catchment (Area 2) Overlay: All Marine Parks (Managed Use) Overlay: All Murray Darling Basin Overlay: All Native Vegetation Overlay: All Non-stop Corridor Overlay: All River Murray Flood Plain Overlay: All River Murray Tributaries Area Overlay: All State Heritage Area Overlay: All State Heritage Place Overlay: All State Significant Native Vegetation Overlay: All Strategic Infrastructure (Gas Pipelines) Overlay: All Urban Transport Routes Overlay: All
All other Code Assessed Development	All	All	None	All

Table 4 – Restricted Development Classification

Class of Development

The following Classes of Development are classified as Restricted

Industry (except light industry)

Assessment Provisions

Desired Outcome (DO)

DO 1

An active retail precinct that includes neighbourhood scale shopping, business, entertainment and recreation facilities. It is a focus for business and community life and provides for most daily and weekly shopping needs of the community. The precinct includes buildings that are well integrated with pedestrian and cycle networks as well as public transport, and sit within a high quality and well activated public realm.

Performance Outcomes and Deemed to Satisfy / Designated Performance Outcome Criteria

Land Use and Intensity

PO 1.1

Shops, office, entertainment, health and recreation related uses supplemented by other businesses that provide a range of goods and services to the surrounding neighbourhood and district.

DTS/DPF 1.1

Development comprises one or more of the following land uses:

Cinema

Community facility

Consulting room

Educational establishment

Emergency services facility

Health facility

Hospital

Hotel

Indoor recreation facility

Library

Office

Place of worship

Pre-school

Public transport terminal

Recreation area

Restaurant

Retail fuel outlet

Service trade premises

Shop

Tourist accommodation.

PO 1.2

Residential development does not prejudice the operation of existing non-residential development and the long term provision of services and facilities for wider community benefit.

DTS 1.2

None are applicable.

PO 1.3

Dwellings developed only in conjunction with non-residential uses to support business, entertainment and recreational activities

DTS 1.3

Dwellings are developed only in conjunction with non-residential uses and sited:

- (a) at upper levels of buildings with non-residential uses located at ground level; or
- (b) behind non-residential uses on the same allotment.

PO 1.4

Where residential development is appropriate having regard to other performance outcomes of the zone, residential development achieves medium-to-high densities.

PO 1.4

Residential development achieves a minimum net density of 35 dwelling units per hectare.

PO 1.5

Bulky goods outlets are sited and designed to achieve or maintain a vibrant and interesting streetscape within retail areas.

DTS/DPF 1.5

Bulky goods outlets with a gross leaseable area of 500m² or more are located towards the periphery of the zone.

Built Form and Character

PO 2.1

Development throughout the zone that integrates with desired development through building scale, connections and complementary land uses.

DTS 2.1

None are applicable.

PO 2.2

Buildings sited and designed to create pedestrian, vehicular, open space and visual linkages between the various built-form elements within the zone and adjoining main roads and thoroughfares.

DTS 2.2

None are applicable.

PO 2.3

Vehicular access points and car parks are coordinated and consolidated to enable the shared use of parking spaces.

DTS 2.3

None are applicable.

PO 2.4

Development promotes the use of pedestrian and cyclist connections to centre facilities and services.

DTS 2.4

None are applicable.

PO 2.5

Non-residential buildings and facilities are sited and designed to create streetscapes and spaces that encourage social interaction.

DTS 2.5

None are applicable.

Building height and setbacks

PO 3.1

A range of low to medium rise buildings, with the highest intensity of built form at the centre of the zone and lower scale at the peripheral zone interface.

DTS/DPF 3.1

Building height is not greater than any maximum, or less than any minimum, specified in the *Maximum Building Height Levels Technical and Numeric Variation Overlay*, the *Maximum Building Height Metres Technical and Numeric Variation Overlay*, or the *Minimum Building Height Levels Technical and Numeric Variation Overlay*.

PO 3.2

Buildings mitigate visual impacts of building massing on residential development within a neighbourhood zone.

DTS/DPF 3.2

Buildings constructed within a building envelope provided by a 45 degree plane measured from a height of 3 metres above natural ground level at the allotment boundary of a residential allotment within a neighbourhood zone as shown in the following diagram (except where this boundary is a southern boundary in which case DTS/DPF 3.3 will apply, or where this boundary is the primary street boundary):

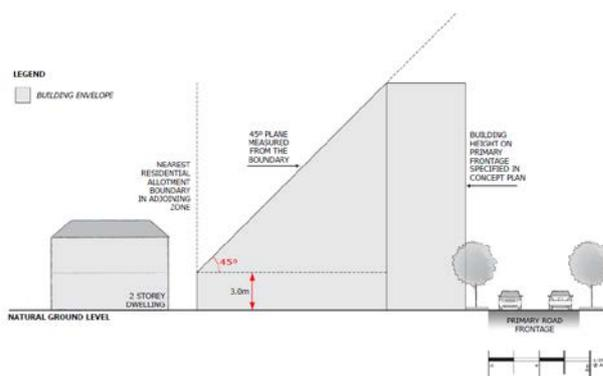

PO 3.3

Buildings mitigate overshadowing of residential development within a neighbourhood zone.

DTS / DPF 3.3

Buildings on sites with a southern boundary adjoining a residential allotment within a neighbourhood zone are constructed within a building envelope provided by a 30 degree plane grading north measured from a height of 3m above natural ground level at the southern boundary, as shown in the following diagram:

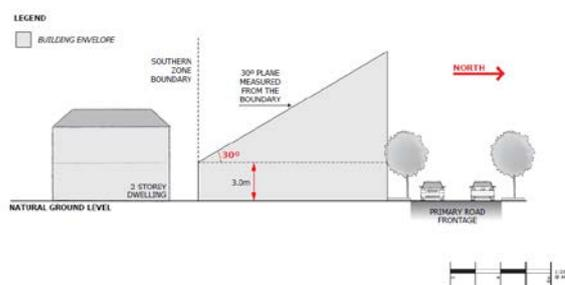

Land Division

PO 4.1

Land division that creates allotments that vary in size and are suitable for a variety of business and community facilities.

DTS 4.1

None are applicable.

Advertisements

PO 5.1

Freestanding advertisements that identify the associated business without creating a visually dominant element within the locality.

DTS 5.1

Freestanding advertisements that:

- a) do not exceed 8m in height; and
- b) do not have a sign face that exceeds 6m² per side

Concept Plans

PO 6.1

Development is compatible with the outcomes sought by any relevant Concept Plan contained within the *Concept Plans Technical and Numeric Variation Overlay*

DTS/DPF 6.1

None are applicable

Procedural Matters (PM)

Notification

All classes of performance assessed development are excluded from notification except where they involve any of the following:

- (a) development on a site located adjacent a dwelling within a Neighbourhood Zone which comprises:
 - (i) development defined as 'all other code assessed development' in Suburban Activity Centre Zone Table 3
 - (ii) construction of a building which fails to comply with DTS 3.1 to 3.3 (inclusive)
 - (iii) the construction of or change of use to a retail fuel outlet, educational establishment, emergency services facility, entertainment venue, hospital, hotel, light industry

Placement of Notices – Exemptions for Performance Assessed Development

None specified.

Placement of Notices – Exemptions for Restricted Development

None specified.

Suburban Neighbourhood Zone

Table 1 – Accepted Development Classification

Class of Development The following Classes of Development are classified as Accepted Development subject to meeting the 'Accepted Development Classification Criteria'	Accepted Development Classification Criteria
<p>Carport Except where any of the following apply:</p> <ul style="list-style-type: none"> • Building Near Airfields Overlay • Character Preservation District Overlay • Coastal Areas Overlay • Hazards (Acid Sulfate Soils) Overlay • Hazards (Flooding) Overlay • Character Area Overlay • Historic Area Overlay • Local Heritage Place Overlay • State Heritage Area Overlay • State Heritage Place Overlay • Native Vegetation Overlay • State Significant Native Vegetation Overlay • Ramsar Wetlands Overlay • River Murray Flood Plain Overlay • Sloping Land Overlay • Future Road Widening Overlay where an existing access is altered or a new access is created • Key Railway Crossings Overlay where an existing access is altered or a new access is created 	<ol style="list-style-type: none"> 1 The development will not be built, or encroach, on an area that is, or will be, required for a sewerage system or waste control system 2 It is ancillary to a dwelling erected on the site 3 Primary street setback – at least 5.5m from the primary street boundary and as far back as the building line of the building to which it is ancillary 4 Secondary street setback – at least 900mm from the boundary of the allotment (if the land has boundaries on two or more roads) 5 Total floor area - does not exceed 40m² 6 Post height - does not exceed 3m measured from natural ground level (and not including a gable end) 7 Building height - does not exceed 5m 8 If situated on or abutting a boundary (not being a boundary with a primary street or secondary street) – a length not exceeding 10m unless: <ol style="list-style-type: none"> (a) a longer wall or structure exists on the adjacent site and is situated on the same allotment boundary; and (b) the proposed wall or structure will be built along the same length of boundary as the existing adjacent wall or structure to the same or lesser extent 9 If the carport abuts or is situated on the boundary of the allotment (not being a boundary with a primary street or secondary street): <ol style="list-style-type: none"> (a) it will not result in all relevant walls or structures located along the boundary exceeding 45% of the length of the boundary; and

Class of Development The following Classes of Development are classified as Accepted Development subject to meeting the 'Accepted Development Classification Criteria'	Accepted Development Classification Criteria
<ul style="list-style-type: none"> • Key Outback and Rural Routes Overlay where an existing access is altered or a new access is created • Major Urban Transport Routes Overlay where an existing access is altered or a new access is created • Non-stop Corridor Overlay where an existing access is altered or a new access is created • Urban Transport Routes Overlay where an existing access is altered or a new access is created Water Resources Overlay	<p>(b) it will not be located within 3m of any other wall along the same boundary unless on an adjacent site on that boundary there is an existing wall of a building that would be adjacent to or abut the proposed wall or structure</p> <p>10 The total roofed area of all existing or proposed buildings on the allotment does not exceed 50% of the area of the allotment</p> <p>11 Door opening for vehicle access – does not exceed, in total, 7m in width or 50% of the width of the allotment frontage (whichever lesser)</p> <p>12 The carport:</p> <p>(a) is located so that vehicle access:</p> <ul style="list-style-type: none"> i. is provided via a lawfully existing or authorised driveway or access point or an access point for which consent has been granted as part of an application for the division of land; or ii. will use a driveway that: <ul style="list-style-type: none"> A. is not located within 6 metres of an intersection of 2 or more roads or a pedestrian actuated crossing; and B. will not interfere with an item of street furniture (including directional signs, lighting, seating and weather shelters), other infrastructure, or a tree; or iii. if adjacent a kerbed road, will be via a kerb that is designed to allow a vehicle to roll over it; and <p>(b) is located so that the gradient from the place of access on the boundary of the allotment to the finished floor level at the front of the carport when the work is completed is not steeper than 1:4 on average; and</p> <p>The centre of the driveway at the public road boundary is no more than 25 degree deviation from the centre of the front of the covered car parking space for which it provides vehicle access</p>
Demolition Except where any of the following apply:	None.

Class of Development

The following Classes of Development are classified as Accepted Development subject to meeting the 'Accepted Development Classification Criteria'

Accepted Development Classification Criteria

- Historic Area Overlay
 - A Local Heritage Place identified in the Local Heritage Place Overlay
 - State Heritage Area Overlay
- A State Heritage Place identified in the State Heritage Place Overlay

Internal building work

Except where any of the following apply:

- A Local Heritage Place identified in the Local Heritage Place Overlay
 - State Heritage Area Overlay
- A State Heritage Place identified in the State Heritage Place Overlay

- 1 There will be no increase in the total floor area of the building
- 2 There will be no alteration to the external appearance of the building.

Outbuilding (in the form of a garage)

Except where any of the following apply:

- Character Preservation District Overlay
- Coastal Areas Overlay
- Hazards (Acid Sulfate Soils) Overlay
- Hazards (Flooding) Overlay
- Character Area Overlay
- Historic Area Overlay
- Local Heritage Place Overlay
- State Heritage Area Overlay
- State Heritage Place Overlay
- Native Vegetation Overlay
- State Significant Native Vegetation Overlay

- 1 The development will not be built, or encroach, on an area that is, or will be, required for a sewerage system or waste control system
- 2 It is detached from and ancillary to a dwelling erected on the site.
- 3 Primary street setback – at least 5.5m from the primary street boundary and as far back as the building line of the building to which it is ancillary
- 4 Secondary street setback – at least 900mm from the boundary of the allotment (if the land has boundaries on two or more roads)
- 5 Total floor area - does not exceed 40m²
- 6 Wall height - does not exceed 3m measured from natural ground level (and not including a gable end)
- 7 Building height - does not exceed 5m
- 8 If situated on or abutting a boundary (not being a boundary with a primary street or secondary street) – a length not exceeding 10m unless:

Class of Development The following Classes of Development are classified as Accepted Development subject to meeting the 'Accepted Development Classification Criteria'	Accepted Development Classification Criteria
<ul style="list-style-type: none"> • Ramsar Wetlands Overlay • River Murray Flood Plain Overlay • Sloping Land Overlay • Future Road Widening Overlay where an existing access is altered or a new access is created • Key Railway Crossings Overlay where an existing access is altered or a new access is created • Key Outback and Rural Routes Overlay where an existing access is altered or a new access is created • Major Urban Transport Routes Overlay where an existing access is altered or a new access is created • Non-stop Corridor Overlay where an existing access is altered or a new access is created • Urban Transport Routes Overlay where an existing access is altered or a new access is created <p>Water Resources Overlay</p>	<ul style="list-style-type: none"> (a) a longer wall or structure exists on the adjacent site and is situated on the same allotment boundary; and (b) the proposed wall or structure will be built along the same length of boundary as the existing adjacent wall or structure to the same or lesser extent <p>9 If the outbuilding abuts or is situated on the boundary of the allotment (not being a boundary with a primary street or secondary street):</p> <ul style="list-style-type: none"> (a) it will not result in all relevant walls or structures located along the boundary exceeding 45% of the length of the boundary; and (b) it will not be located within 3m of any other wall along the same boundary unless on an adjacent site on that boundary there is an existing wall of a building that would be adjacent to or abut the proposed wall or structure <p>10 Total roofed area of all existing and proposed buildings on the allotment - does not exceed 50%</p> <p>11 Door opening for vehicle access – does not exceed, in total, 7m in width or 50% of the width of the allotment frontage (whichever lesser)</p> <p>12 The garage:</p> <ul style="list-style-type: none"> (a) is located so that vehicle access: <ul style="list-style-type: none"> i. is provided via a lawfully existing or authorised driveway or access point or an access point for which consent has been granted as part of an application for the division of land; or ii. will use a driveway that: <ul style="list-style-type: none"> A. is not located within 6 metres of an intersection of 2 or more roads or a pedestrian actuated crossing; and B. will not interfere with an item of street furniture (including directional signs, lighting, seating and weather shelters), other infrastructure, or a tree; or iii. if adjacent a kerbed road, will be via a kerb that is designed to allow a vehicle to roll over it; and

Class of Development

The following Classes of Development are classified as Accepted Development subject to meeting the 'Accepted Development Classification Criteria'

Accepted Development Classification Criteria

- (b) is located so that the gradient from the place of access on the boundary of the allotment to the finished floor level at the front of the carport when the work is completed is not steeper than 1:4 on average; and
 - (c) The centre of the driveway at the public road boundary is no more than 25 degree deviation from the centre of the front of the covered car parking space for which it provides vehicle access
- 2 If clad in sheet metal—is pre-colour treated or painted in a non-reflective colour.

Outbuilding (not being a garage)

Except where any of the following apply:

- Character Preservation District Overlay
- Coastal Areas Overlay
- Hazards (Acid Sulfate Soils) Overlay
- Hazards (Flooding) Overlay
- Character Area Overlay
- Historic Area Overlay
- Local Heritage Place Overlay
- State Heritage Area Overlay
- State Heritage Place Overlay
- Native Vegetation Overlay
- State Significant Native Vegetation Overlay
- Ramsar Wetlands Overlay
- River Murray Flood Plain Overlay
- Sloping Land Overlay
- Water Resources Overlay

- 36 The development will not be built, or encroach, on an area that is, or will be, required for a sewerage system or waste control system
- 37 It is detached from and ancillary to a dwelling erected on the site
- 38 Primary street setback – at least as far back as the building line of the building to which it is ancillary
- 39 Secondary street setback – at least 900mm from the boundary of the allotment (if the land has boundaries on two or more roads)
- 40 Side boundary setbacks – at least 900mm from the boundary of the allotment
- 41 Total floor area does not exceed 40m²
- 42 Wall height - does not exceed 3m measured from natural ground level (and not including a gable end)
- 43 Building height - does not exceed 5m
- 44 If situated on or abutting a boundary (not being a boundary with a primary street or secondary street) – a length not exceeding 10m unless:
 - (a) a longer wall or structure exists on the adjacent site and is situated on the same allotment boundary; and
 - (b) the proposed wall or structure will be built along the same length of boundary as the existing adjacent wall or structure to the same or lesser extent

Class of Development The following Classes of Development are classified as Accepted Development subject to meeting the 'Accepted Development Classification Criteria'	Accepted Development Classification Criteria
	<p>45 If the outbuilding abuts or is situated on the boundary of the allotment (not being a boundary with a primary street or secondary street):</p> <p>(a) it will not result in all relevant walls or structures located along the boundary exceeding 45% of the length of the boundary; and</p> <p>(b) will not be located within 3m of any other wall along the same boundary unless on an adjacent site on that boundary there is an existing wall of a building that would be adjacent to or abut the proposed wall or structure</p> <p>46 Total roofed area of all existing and proposed buildings on the allotment - does not exceed 50%</p> <p>If clad in sheet metal—is pre-colour treated or painted in a non-reflective colour.</p>
Shade sail Except where any of the following apply: <ul style="list-style-type: none"> • Character Preservation District Overlay • Coastal Areas Overlay • Hazards (Acid Sulfate Soils) Overlay • Character Area Overlay • Historic Area Overlay • Local Heritage Place Overlay • State Heritage Area Overlay • State Heritage Place Overlay • State Significant Native Vegetation Overlay • Ramsar Wetlands Overlay • River Murray Flood Plain Overlay • Sloping Land Overlay • Water Resources Overlay 	<p>29 The development will not be built, or encroach, on an area that is, or will be, required for a sewerage system or waste control system</p> <p>30 Shade sail consists of permeable material</p> <p>31 The total area of the sail - does not exceed 40m²</p> <p>32 No part of the shade sail will be:</p> <p>(a) 3m above ground or floor level (depending on where it is situated) at any place within 900mm of a boundary of the allotment</p> <p>(b) 5m above ground or floor level (depending on where it is situated) within any other part of the allotment</p> <p>33 Primary street setback – at least as far back as the building line of the building to which it is ancillary</p> <p>34 If any part of the sail will be situated on a boundary of the allotment, the length of sail along a boundary does not exceed 8m</p> <p>14 In a case where any part of the sail or a supporting structure will be situated on a side boundary of the allotment — the length of the sail and any such supporting structure</p>

Class of Development The following Classes of Development are classified as Accepted Development subject to meeting the 'Accepted Development Classification Criteria'	Accepted Development Classification Criteria
	together with all relevant walls or structures located along the boundary will not exceed 45% of the length of the boundary.
Solar photovoltaic panels (roof mounted) Except where any of the following apply: <ul style="list-style-type: none"> • Historic Area Overlay • A Local Heritage Place identified in the Local Heritage Place Overlay • State Heritage Area Overlay A State Heritage Place identified in the State Heritage Place Overlay	13 Panels are installed parallel to the roof of a building and with the underside surface of the panel not being more than 100mm above the surface of the roof 14 Panels and associated components do not overhang any part of the roof Does not apply to system with a generating capacity of more than 5MW that is to be connected to the State's power system.
Spa pool Swimming pool Except where any of the following apply: <ul style="list-style-type: none"> • Character Preservation District Overlay • Coastal Areas Overlay • Hazards (Acid Sulfate Soils) Overlay • Hazards (Flooding) Overlay • Character Area Overlay • Historic Area Overlay • Local Heritage Place Overlay • State Heritage Area Overlay • State Heritage Place Overlay • Native Vegetation Overlay • State Significant Native Vegetation Overlay • Ramsar Wetlands Overlay 	41 The development will not be built, or encroach, on an area that is, or will be, required for a sewerage system or waste control system 42 It is ancillary to a dwelling erected on the site 43 Allotment boundary setback – not less than 1m 44 Primary street setback – at least as far back as the building line of the building to which it is ancillary 45 Location of filtration system from a dwelling on an adjoining allotment: <ul style="list-style-type: none"> (a) not less than 5m where the filtration system is located inside a solid structure that will have material impact on the transmission of noise not less than 12m in any other case.

Class of Development

The following Classes of Development are classified as Accepted Development subject to meeting the 'Accepted Development Classification Criteria'

Accepted Development Classification Criteria

- River Murray Flood Plain Overlay
 - Sloping Land Overlay
- Water Resources Overlay.

Verandah

Except where any of the following apply:

- Character Preservation District Overlay
- Coastal Areas Overlay
- Hazards (Acid Sulfate Soils) Overlay
- Hazards (Flooding) Overlay
- Character Area Overlay
- Historic Area Overlay
- Local Heritage Place Overlay
- State Heritage Area Overlay
- State Heritage Place Overlay
- Native Vegetation Overlay
- State Significant Native Vegetation Overlay
- Ramsar Wetlands Overlay
- River Murray Flood Plain Overlay

Water Resources Overlay

Water tank (above ground)

Except where any of the following apply:

- Character Preservation District Overlay
- Coastal Areas Overlay
- Hazards (Flooding) Overlay
- Character Area Overlay
- Historic Area Overlay

- 24 The development will not be built, or encroach, on an area that is, or will be, required for a sewerage system or waste control system
- 25 It is ancillary to a dwelling erected on the site
- 26 Primary street setback – as far back as the building line of the building to which it is ancillary
- 27 Total floor area - does not exceed 40m²
- 28 Post height - does not exceed 3m measured from natural ground level
- 29 Building height - does not exceed 5m
- 30 Length - does not exceed 10m if any part of the structure abuts or is situated on a boundary of the allotment
- 17 Total roofed area of all existing and proposed buildings on the allotment - does not exceed 50%.

- 22 The development will not be built, or encroach, on an area that is, or will be, required for a sewerage system or waste control system
- 23 The tank is part of a roof drainage system
- 24 Total floor area - not exceeding 15m²
- 25 The tank is located wholly above ground
- 26 Tank height – does not exceed 4m above natural ground level

Class of Development The following Classes of Development are classified as Accepted Development subject to meeting the 'Accepted Development Classification Criteria'	Accepted Development Classification Criteria
<ul style="list-style-type: none"> • Local Heritage Place Overlay • State Heritage Area Overlay • State Heritage Place Overlay • Native Vegetation Overlay • State Significant Native Vegetation Overlay • Ramsar Wetlands Overlay • River Murray Flood Plain Overlay • Sloping Land Overlay Water Resources Overlay	<p>27 Primary street setback – at least as far back as the building line of the building to which it is ancillary</p> <p>1 In the case of a tank made of metal – the tank is pre-colour treated or painted in a non-reflective colour.</p>
<p>Water tank (underground) Except where any of the following apply:</p> <ul style="list-style-type: none"> • Character Preservation District Overlay • Coastal Areas Overlay • Hazards (Acid Sulfate Soils) Overlay • Native Vegetation Overlay • State Significant Native Vegetation Overlay • Ramsar Wetlands Overlay • Sloping Land Overlay Water Resources Overlay	<p>9 The development will not be built, or encroach, on an area that is, or will be, required for a sewerage system or waste control system</p> <p>The tank (including any associated pump) is located wholly below the level of the ground.</p>

Table 2 – Deemed-to-Satisfy Development Classification

Class of Development The following Classes of Development are classified as Deemed-to-Satisfy Development subject to meeting the 'Deemed-to-Satisfy Development Classification Criteria'	Deemed-to-Satisfy Development Classification Criteria Provisions referred to are Deemed-to-Satisfy Criteria Where a development comprises more than one Class of Development the relevant criteria will be taken to be the sum of the criteria for each Class of Development.			
	Zone	General Development Policies	Subzone (applies only in the area affected by the Subzone)	Overlay (applies only in the area affected by the Overlay)
Ancillary accommodation Except where Located within the Underground Subzone Aircraft Noise Exposure Overlay Building Near Airfields Overlay Character Area Overlay Character Preservation District Overlay Coastal Areas Overlay Hazards (Bushfire-High Risk) Overlay		Design in Urban Areas [All Residential Development – Ancillary Development]: PO 17.1, 17.2	All	Airport Building Heights (Aircraft Landing Areas) Overlay: All Airport Building Heights (Regulated) Overlay: All Major Urban Transport Routes Overlay [Corner Cut-Offs]: All Key Railway Crossings Overlay: All Native Vegetation Overlay [Environmental Protection]: DTS 1.1 State Significant Native Vegetation Areas Overlay [Environmental Protection]: All Future Road Widening Overlay: All

Class of Development

The following Classes of Development are classified as Deemed-to-Satisfy Development subject to meeting the 'Deemed-to-Satisfy Development Classification Criteria'

Deemed-to-Satisfy Development Classification Criteria

Provisions referred to are Deemed-to-Satisfy Criteria

Where a development comprises more than one Class of Development the relevant criteria will be taken to be the sum of the criteria for each Class of Development.

Zone	General Development Policies	Subzone (applies only in the area affected by the Subzone)	Overlay (applies only in the area affected by the Overlay)
-------------	-------------------------------------	--	--

- Hazards (Medium-Risk) Overlay
- Hazards (General-Risk) Overlay
- Hazards (Urban Interface) Overlay
- Hazards (Flooding) Overlay
- Historic Areas Overlay
- Local Heritage Place Overlay
- Marine Parks (Managed Use) Overlay
- Mt Lofty Ranges Catchment (Area 2) Overlay
- Noise and Air Emission Overlay
- Ramsar Wetlands Overlay

- Hazards (Acid Sulfate Soils) Overlay: All
- Urban Transport Routes Overlay [Corner Cut-Offs]: All

Class of Development
 The following Classes of Development are classified as Deemed-to-Satisfy Development subject to meeting the 'Deemed-to-Satisfy Development Classification Criteria'

Deemed-to-Satisfy Development Classification Criteria
 Provisions referred to are Deemed-to-Satisfy Criteria
 Where a development comprises more than one Class of Development the relevant criteria will be taken to be the sum of the criteria for each Class of Development.

Zone	General Development Policies	Subzone (applies only in the area affected by the Subzone)	Overlay (applies only in the area affected by the Overlay)
-------------	-------------------------------------	--	--

River Murray Tributaries Overlay
 River Murray Flood Plain Overlay
 Significant Industry Interface Overlay
 State Heritage Area Overlay
 State Heritage Place Overlay
 Sloping Land Overlay

Carport
Outbuilding (in the form of a garage)
 Except where the following apply:

Design in Urban Areas [All Residential Development – Ancillary Development]:
 DTS 17.1, 17.2

Airport Building Heights (Aircraft Landing Areas) Overlay: All
 Airport Building Heights (Regulated) Overlay: All

Class of Development

The following Classes of Development are classified as Deemed-to-Satisfy Development subject to meeting the 'Deemed-to-Satisfy Development Classification Criteria'

Deemed-to-Satisfy Development Classification Criteria

Provisions referred to are Deemed-to-Satisfy Criteria

Where a development comprises more than one Class of Development the relevant criteria will be taken to be the sum of the criteria for each Class of Development.

	Zone	General Development Policies	Subzone (applies only in the area affected by the Subzone)	Overlay (applies only in the area affected by the Overlay)
Character Area Overlay Character Preservation District Overlay Coastal Areas Overlay Historic Areas Overlay Hazards (Bushfire-High Risk) Overlay Hazards (Medium-Risk) Overlay Hazards (General-Risk) Overlay Hazards (Urban Interface) Overlay Hazards (Flooding) Overlay Local Heritage Place Overlay		Design in Urban Areas [Residential Development – 3 Building Levels or Less – External Appearance]: DTS 19.1 Design in Urban Areas [Residential Development – 3 Building Levels or Less – Car parking, Access and Manoeuvrability]: All Transport, Access and Parking [Vehicle Access]: DTS 3.1, 3.4, 3.5		Key Outback and Rural Route: All Key Railway Crossings Overlay: All Major Urban Transport Routes Overlay: All Native Vegetation Overlay [Environmental Protection]: DTS 1.1 State Significant Native Vegetation Areas Overlay [Environmental Protection]: All Future Road Widening Overlay: All Hazards (Acid Sulfate Soils) Overlay: All Urban Transport Routes Overlay: All

Class of Development

The following Classes of Development are classified as Deemed-to-Satisfy Development subject to meeting the 'Deemed-to-Satisfy Development Classification Criteria'

Deemed-to-Satisfy Development Classification Criteria

Provisions referred to are Deemed-to-Satisfy Criteria

Where a development comprises more than one Class of Development the relevant criteria will be taken to be the sum of the criteria for each Class of Development.

	Zone	General Development Policies	Subzone (applies only in the area affected by the Subzone)	Overlay (applies only in the area affected by the Overlay)
Marine Parks (Managed Use) Overlay Mt Lofty Ranges Catchment (Area 2) Overlay Non-Stop Corridors Overlay River Murray Tributaries Overlay River Murray Flood Plain Overlay State Heritage Area Overlay State Heritage Place Overlay Sloping Land Overlay				
<p>Dwelling addition Except where</p>	[Site Coverage]: PO 3.1	Clearance from Overhead Powerlines: DTS 1.1	All	Airport Building Heights (Aircraft Landing Areas) Overlay: All

Class of Development

The following Classes of Development are classified as Deemed-to-Satisfy Development subject to meeting the 'Deemed-to-Satisfy Development Classification Criteria'

Deemed-to-Satisfy Development Classification Criteria

Provisions referred to are Deemed-to-Satisfy Criteria

Where a development comprises more than one Class of Development the relevant criteria will be taken to be the sum of the criteria for each Class of Development.

	Zone	General Development Policies	Subzone (applies only in the area affected by the Subzone)	Overlay (applies only in the area affected by the Overlay)
Located in the Underground Subzone Aircraft Noise Exposure Overlay Building Near Airfields Overlay Character Area Overlay Character Preservation District Overlay Coastal Areas Overlay Hazards (Bushfire-High Risk) Overlay Hazards (Medium-Risk) Overlay Hazards (General-Risk) Overlay	[Building Height]: PO 4.1 [Primary Street Setback]: PO 5.1 [Secondary Street Setback]: PO 6.1 [Boundary Walls] PO 7.1, 7.2 [Side Boundary Setback] PO 8.1 [Rear Boundary Setback] PO 9.1	Infrastructure and Renewable Energy Facilities [Water Supply]: DTS 11.2 Infrastructure and Renewable Energy Facilities [Wastewater Services]: DTS 12.1, 12.2 Design in Urban Areas [All Residential Development – External Appearance]: DTS 14.1 Design in Urban Areas [All Residential Development – Outlook and Amenity]: DTS 15.1 Design in Urban Areas [All Residential Development – 3 Building Levels or Less – External Appearance]: DTS 19.1, 19.2, 19.3 Design in Urban Areas [All Residential Development – 3 Building Levels or		Airport Building Heights (Regulated) Overlay: All Key Outback and Rural Route: All Key Railway Crossings Overlay: All Major Urban Transport Routes Overlay [Access – Safe Entry and Exit: All Native Vegetation Overlay [Environmental Protection]: DTS 1.1 State Significant Native Vegetation Areas Overlay [Environmental Protection]: DTS 1.1 Future Road Widening Overlay: All

Class of Development

The following Classes of Development are classified as Deemed-to-Satisfy Development subject to meeting the 'Deemed-to-Satisfy Development Classification Criteria'

Deemed-to-Satisfy Development Classification Criteria

Provisions referred to are Deemed-to-Satisfy Criteria

Where a development comprises more than one Class of Development the relevant criteria will be taken to be the sum of the criteria for each Class of Development.

	Zone	General Development Policies	Subzone (applies only in the area affected by the Subzone)	Overlay (applies only in the area affected by the Overlay)
Hazards (Urban Interface) Overlay Hazards (Flooding) Overlay Historic Areas Overlay Local Heritage Place Overlay Marine Parks (Managed Use) Overlay Mt Lofty Ranges Catchment (Area 2) Overlay Non-Stop Corridors Overlay Noise and Air Emission Overlay Ramsar Wetlands Overlay River Murray Tributaries Overlay		Less –Overlooking / Visual Privacy]: DTS 20.1 Design in Urban Areas [All Residential Development – 3 Building Levels or Less –Private Open Space]: DTS 21.1, 21.2 Design in Urban Areas [All Residential Development – 3 Building Levels or Less –Landscaping]: DTS 22.1, 22.2 Design in Urban Areas [All Residential Development – 3 Building Levels or Less – Waste Storage]: DTS 25.1 Interface Between Land Uses [Overshadowing]: DTS 3.1, 3.2 Interface Between Land Uses [Activities Generating Noise or Vibration]: DTS 4.4 Site Contamination: DTS 1.1		Hazards (Acid Sulfate Soils) Overlay: All Urban Transport Routes Overlay: All

Class of Development The following Classes of Development are classified as Deemed-to-Satisfy Development subject to meeting the 'Deemed-to-Satisfy Development Classification Criteria'	Deemed-to-Satisfy Development Classification Criteria Provisions referred to are Deemed-to-Satisfy Criteria Where a development comprises more than one Class of Development the relevant criteria will be taken to be the sum of the criteria for each Class of Development.			
	Zone	General Development Policies	Subzone (applies only in the area affected by the Subzone)	Overlay (applies only in the area affected by the Overlay)
River Murray Flood Plain Overlay Significant Industry Interface Overlay State Heritage Area Overlay State Heritage Place Overlay Sloping Land Overlay				
Detached Dwelling (not being in a Battle-axe arrangement) Except where: located within the Underground Subzone;	[Site Dimensions and Land Division]: DTS 2.1, 2.2 [Site Coverage]: DTS 3.1 [Building Height]: DTS 4.1	Clearance from Overhead Powerlines: DTS 1.1 Infrastructure and Renewable Energy Facilities [Water Supply]: DTS 11.2 Infrastructure and Renewable Energy Facilities [Wastewater Services]: DTS 12.1, 12.2	All	Affordable Housing Overlay: All Airport Building Heights (Aircraft Landing Areas) Overlay: All Airport Building Heights (Regulated) Overlay: All Key Outback and Rural Route Overlay: All

Class of Development

The following Classes of Development are classified as Deemed-to-Satisfy Development subject to meeting the 'Deemed-to-Satisfy Development Classification Criteria'

Deemed-to-Satisfy Development Classification Criteria

Provisions referred to are Deemed-to-Satisfy Criteria

Where a development comprises more than one Class of Development the relevant criteria will be taken to be the sum of the criteria for each Class of Development.

	Zone	General Development Policies	Subzone (applies only in the area affected by the Subzone)	Overlay (applies only in the area affected by the Overlay)
Aircraft Noise Exposure Overlay Building Near Airfields Overlay Character Area Overlay Character Preservation District Overlay Coastal Areas Overlay Hazards (Bushfire-High Risk) Overlay Hazards (Medium-Risk) Overlay Hazards (General-Risk) Overlay Hazards (Urban Interface) Overlay Hazards (Flooding) Overlay	[Primary Street Setback]: 5.1 [Secondary Street Setback]: DTS 6.1 [Boundary Walls]: DTS 7.1, 7.2 [Side Boundary Setbacks]: DTS 8.1 [Rear Boundary Setbacks]: 9.1	Transport, Access and Parking [Vehicle Parking Rates]: DTS 5.1 Design in Urban Areas [All Development – Car Parking Appearance]: DTS 6.1 Design in Urban Areas [All Residential Development – External Appearance]: DTS 14.1, 14.2 Design in Urban Areas [All Residential Development – Outlook and Amenity]: DTS 15.1 Design in Urban Areas [All Residential Development – Access and Servicing]: DTS 16.1 Design in Urban Areas [All Residential Development – Flooding]: DTS 18.1 Design in Urban Areas [All Residential Development – 3 Building Levels or		Key Railway Crossings Overlay: All Major Urban Transport Routes Overlay: All Native Vegetation Overlay [Environmental Protection]: DTS 1.1 State Significant Native Vegetation Areas Overlay [Environmental Protection]: DTS 1.1 Future Road Widening Overlay: All Hazards (Acid Sulfate Soils) Overlay: All Urban Transport Routes Overlay: All

Class of Development

The following Classes of Development are classified as Deemed-to-Satisfy Development subject to meeting the 'Deemed-to-Satisfy Development Classification Criteria'

Deemed-to-Satisfy Development Classification Criteria

Provisions referred to are Deemed-to-Satisfy Criteria

Where a development comprises more than one Class of Development the relevant criteria will be taken to be the sum of the criteria for each Class of Development.

Zone	General Development Policies	Subzone (applies only in the area affected by the Subzone)	Overlay (applies only in the area affected by the Overlay)
-------------	-------------------------------------	--	--

- Historic Areas Overlay
- Local Heritage Place Overlay
- Marine Parks (Managed Use) Overlay
- Mt Lofty Ranges Catchment (Area 2) Overlay
- Non-Stop Corridors Overlay
- Noise and Air Emission Overlay
- Ramsar Wetlands Overlay
- River Murray Tributaries Overlay
- River Murray Flood Plain Overlay
- Significant Industry Interface Overlay

Less – External Appearance]: DTS 19.1, 19.2, 19.3

Design in Urban Areas [All Residential Development – 3 Building Levels or Less –Overlooking / Visual Privacy]: DTS 20.1

Design in Urban Areas [All Residential Development – 3 Building Levels or Less –Private Open Space]: DTS 21.1, 21.2

Design in Urban Areas [All Residential Development – 3 Building Levels or Less –Landscaping]: DTS 22.1, 22.2

Design in Urban Areas [All Residential Development – 3 Building Levels or Less – Water Sensitive Design]: DTS 23.1, 23.2, 23.3

Design in Urban Areas [All Residential Development – 3 Building Levels or

Class of Development

The following Classes of Development are classified as Deemed-to-Satisfy Development subject to meeting the 'Deemed-to-Satisfy Development Classification Criteria'

Deemed-to-Satisfy Development Classification Criteria

Provisions referred to are Deemed-to-Satisfy Criteria
 Where a development comprises more than one Class of Development the relevant criteria will be taken to be the sum of the criteria for each Class of Development.

	Zone	General Development Policies	Subzone (applies only in the area affected by the Subzone)	Overlay (applies only in the area affected by the Overlay)
State Heritage Area Overlay State Heritage Place Overlay Sloping Land Overlay		Less – Car Parking and Manoeuvrability]: DTS 24.1, 24.2, 24.3, 24.4, 24.5, 24.6 Design in Urban Areas [All Residential Development – 3 Building Levels or Less – Waste Storage]: DTS 25.1 Interface Between Land Uses [Overshadowing]: DTS 3.1, 3.2 Interface Between Land Uses [Interface Between Rural Activities]: DTS 9.3, 9.4, 9.5 Interface Between Land Uses [Interface with Mines and Quarries (Rural and Remote Areas): DTS 10.1 Site Contamination: DTS 1.1		

Class of Development

The following Classes of Development are classified as Deemed-to-Satisfy Development subject to meeting the 'Deemed-to-Satisfy Development Classification Criteria'

Deemed-to-Satisfy Development Classification Criteria

Provisions referred to are Deemed-to-Satisfy Criteria

Where a development comprises more than one Class of Development the relevant criteria will be taken to be the sum of the criteria for each Class of Development.

Zone	General Development Policies	Subzone (applies only in the area affected by the Subzone)	Overlay (applies only in the area affected by the Overlay)
-------------	-------------------------------------	--	--

Dwelling, dwellings or residential flat building undertaken by:

a) the South Australian Housing Trust either individually or jointly with other persons or bodies; or

b) registered Community Housing providers participating in housing renewal programs endorsed by the South Australian Housing Authority

located within the Underground Subzone;

Housing Renewal: All DTS

- Affordable Housing Overlay [Land Division] DTS 1.1
- Airport Building Heights (Aircraft Landing Areas) Overlay: All
- Airport Building Heights (Regulated) Overlay: All
- Key Outback and Rural Route: All
- Key Railway Crossings Overlay: All
- Major Urban Transport Routes Overlay: All
- Native Vegetation Overlay [Environmental Protection]: DTS 1.1
- State Significant Native Vegetation Areas Overlay [Environmental Protection]: DTS 1.1

Class of Development

The following Classes of Development are classified as Deemed-to-Satisfy Development subject to meeting the 'Deemed-to-Satisfy Development Classification Criteria'

Deemed-to-Satisfy Development Classification Criteria

Provisions referred to are Deemed-to-Satisfy Criteria

Where a development comprises more than one Class of Development the relevant criteria will be taken to be the sum of the criteria for each Class of Development.

Zone	General Development Policies	Subzone (applies only in the area affected by the Subzone)	Overlay (applies only in the area affected by the Overlay)
-------------	-------------------------------------	--	--

- Aircraft Noise Exposure Overlay
- Building Near Airfields Overlay
- Character Area Overlay
- Character Preservation District Overlay
- Coastal Areas Overlay
- Hazards (Bushfire-High Risk) Overlay
- Hazards (Medium-Risk) Overlay
- Hazards (General-Risk) Overlay
- Hazards (Urban Interface) Overlay
- Hazards (Flooding) Overlay

- Future Road Widening Overlay: All
- Hazards (Acid Sulfate Soils) Overlay: All
- Urban Transport Routes Overlay: All

Class of Development

The following Classes of Development are classified as Deemed-to-Satisfy Development subject to meeting the 'Deemed-to-Satisfy Development Classification Criteria'

Deemed-to-Satisfy Development Classification Criteria

Provisions referred to are Deemed-to-Satisfy Criteria

Where a development comprises more than one Class of Development the relevant criteria will be taken to be the sum of the criteria for each Class of Development.

Zone	General Development Policies	Subzone (applies only in the area affected by the Subzone)	Overlay (applies only in the area affected by the Overlay)
-------------	-------------------------------------	--	--

- Historic Areas Overlay
- Local Heritage Place Overlay
- Marine Parks (Managed Use) Overlay
- Mt Lofty Ranges Catchment (Area 2) Overlay
- Non-Stop Corridors Overlay
- Noise and Air Emission Overlay
- Ramsar Wetlands Overlay
- River Murray Tributaries Overlay
- River Murray Flood Plain Overlay
- Significant Industry Interface Overlay

Class of Development
 The following Classes of Development are classified as Deemed-to-Satisfy Development subject to meeting the 'Deemed-to-Satisfy Development Classification Criteria'

Deemed-to-Satisfy Development Classification Criteria
 Provisions referred to are Deemed-to-Satisfy Criteria
 Where a development comprises more than one Class of Development the relevant criteria will be taken to be the sum of the criteria for each Class of Development.

Zone	General Development Policies	Subzone (applies only in the area affected by the Subzone)	Overlay (applies only in the area affected by the Overlay)
-------------	-------------------------------------	--	--

State Heritage Area Overlay
 State Heritage Place Overlay
 Sloping Land Overlay

Excavation and filling
 Except where
 Character Area Overlay
 Character Preservation District Overlay
 Coastal Areas Overlay
 Hazards (Flooding) Overlay
 Historic Areas Overlay

Design in Urban Areas [All Development – Fences and Walls]: DTS 8.2

Native Vegetation Overlay [Environmental Protection]: DTS 1.1
 State Significant Native Vegetation Areas Overlay [Environmental Protection]: DTS 1.1

Class of Development

The following Classes of Development are classified as Deemed-to-Satisfy Development subject to meeting the 'Deemed-to-Satisfy Development Classification Criteria'

Deemed-to-Satisfy Development Classification Criteria

Provisions referred to are Deemed-to-Satisfy Criteria

Where a development comprises more than one Class of Development the relevant criteria will be taken to be the sum of the criteria for each Class of Development.

Zone	General Development Policies	Subzone (applies only in the area affected by the Subzone)	Overlay (applies only in the area affected by the Overlay)
-------------	-------------------------------------	--	--

- Local Heritage Place Overlay
- Marine Parks (Managed Use) Overlay
- Mt Lofty Ranges Catchment (Area 2) Overlay
- Ramsar Wetlands Overlay
- River Murray Tributaries Overlay
- River Murray Flood Plain Overlay
- State Heritage Area Overlay
- State Heritage Place Overlay
- Sloping Land Overlay

Class of Development

The following Classes of Development are classified as Deemed-to-Satisfy Development subject to meeting the 'Deemed-to-Satisfy Development Classification Criteria'

Deemed-to-Satisfy Development Classification Criteria

Provisions referred to are Deemed-to-Satisfy Criteria

Where a development comprises more than one Class of Development the relevant criteria will be taken to be the sum of the criteria for each Class of Development.

Zone	General Development Policies	Subzone (applies only in the area affected by the Subzone)	Overlay (applies only in the area affected by the Overlay)
-------------	-------------------------------------	--	--

Outbuilding (not being a garage)
Verandah
Except where the following apply:
Character Area Overlay
Character Preservation District Overlay
Coastal Areas Overlay
Hazards (Flooding) Overlay
Historic Areas Overlay
Local Heritage Place Overlay
Marine Parks (Managed Use) Overlay
Mt Lofty Ranges Catchment (Area 2) Overlay

Design in Urban Areas [All Residential Development – Ancillary Development]:
DTS 17.1, 17.2

Major Urban Transport Routes Overlay [Corner Cut-Offs]: All
Native Vegetation Overlay [Environmental Protection]: DTS 1.1
State Significant Native Vegetation Areas Overlay [Environmental Protection]: All
Future Road Widening Overlay: All
Hazards (Acid Sulfate Soils) Overlay: All
Urban Transport Routes Overlay [Corner Cut-Offs]: All

Class of Development

The following Classes of Development are classified as Deemed-to-Satisfy Development subject to meeting the 'Deemed-to-Satisfy Development Classification Criteria'

Deemed-to-Satisfy Development Classification Criteria

Provisions referred to are Deemed-to-Satisfy Criteria

Where a development comprises more than one Class of Development the relevant criteria will be taken to be the sum of the criteria for each Class of Development.

Zone	General Development Policies	Subzone (applies only in the area affected by the Subzone)	Overlay (applies only in the area affected by the Overlay)
-------------	-------------------------------------	--	--

- River Murray Tributaries Overlay
- River Murray Flood Plain Overlay
- State Heritage Area Overlay
- State Heritage Place Overlay
- Sloping Land Overlay

--	--	--	--

Table 3 - Applicable Policies for Performance Assessed Development

Class of Development	Applicable Policies			
	Zone	General Development Policies	Subzone (applies only in the area affected by the Subzone)	Overlay (applies only in the area affected by the Overlay)
Ancillary accommodation		Design in Urban Areas [All Residential Development – Ancillary Development]: PO 17.1, 17.2		Aircraft Noise Exposure Overlay: All Airport Building Heights (Aircraft Landing Area) Overlay: All Airport Building Heights (Regulated) Overlay: All Building Near Airfields: All Character Preservation District Overlay: All Coastal Areas Overlay: All Character Area Overlay: All Future Road Widening Overlay: All Hazards (Acid Sulfate Soils) Overlay: All Hazards (Bushfire-High Risk) Overlay: All Hazards (Medium-Risk) Overlay: All Hazards (General-Risk) Overlay: All Hazards (Urban Interface) Overlay: All Hazards (Flooding) Overlay: All Historic Areas Overlay: All Local Heritage Place Overlay: All Major Urban Transport Routes Overlay: All Mt Lofty Ranges Catchment (Area 2) Overlay: All Native Vegetation Overlay: All Noise and Air Emission Overlay: All Ramsar Wetlands Overlay: All River Murray Tributaries Overlay: All River Murray Flood Plain Overlay: All Significant Industry Interface Overlay: All

Class of Development	Applicable Policies			
	Zone	General Development Policies	Subzone (applies only in the area affected by the Subzone)	Overlay (applies only in the area affected by the Overlay)
				State Significant Native Vegetation Areas Overlay: All State Heritage Area Overlay: All State Heritage Place Overlay: All Sloping Land Overlay: All
Carport Outbuilding (in the form of a garage)		Design in Urban Areas [All Residential Development – Ancillary Development]: PO 17.1, 17.2 Design in Urban Areas [Residential Development – 3 Building Levels or Less – External Appearance]: PO 19.1 Design in Urban Areas [Residential Development – 3 Building Levels or Less – Car parking, Access and Manoeuvrability]: All Transport, Access and Parking [Vehicle Access]: PO 3.1, 3.4, 3.5		Airport Building Heights (Aircraft Landing Area) Overlay: All Airport Building Heights (Regulated) Overlay: All Building Near Airfields: All Coastal Areas: All Future Road Widening: All Hazards (Flooding): All Historic Area: All Local Heritage Place: All Major Urban Transport Routes: All Noise and Air Emissions: All Regulated Trees: All Sloping Land: All State Heritage Area: All State Heritage Place: All Local Heritage Place Overlay: All Character Area Overlay: All Historic Areas Overlay: All Urban Transport Routes: All Key Outback and Rural Route Overlay All

Class of Development	Applicable Policies			
	Zone	General Development Policies	Subzone (applies only in the area affected by the Subzone)	Overlay (applies only in the area affected by the Overlay)
				Key Railway Crossings Overlay: All Major Urban Transport Routes: All Native Vegetation Overlay [Environmental Protection]: All State Significant Native Vegetation Areas Overlay: All Mt Lofty Ranges Catchment (Area 2) Overlay: All Future Road Widening Overlay: All Hazards (Acid Sulfate Soils) Overlay: All Non-Stop Corridors Overlay: All Character Preservation District Overlay: All Hazards (Flooding) Overlay: All Coastal Areas Overlay : All River Murray Tributaries Overlay: All River Murray Flood Plain Overlay: All
Consulting room Office Preschool	[Land Use and Intensity]: PO 1.3, 1.4, PO 1.5, PO 1.6 [Site Coverage]: PO 3.1 [Building Height]: PO 4.1 [Primary Street Setback]: PO 5.1 [Secondary Street Setback]: PO 6.1 [Boundary Walls]: PO 7.1 [Side Boundary Setback]: PO 8.1	Clearance from Overhead Powerlines: PO 1.1 Design in Urban Areas [External Appearance]: PO 1.4 Design in Urban Areas [Car Parking Appearance]: PO 6.1, 6.4, 6.5 Design in Urban Areas [Water Sensitive Design]: PO 42.1, 42.3 Interface Between Land Uses [Hours of Operation]: PO 2.1 Interface Between Land Uses [Overshadowing]: PO 3.1, 3.2		Aircraft Noise Exposure Overlay: All Airport Building Heights (Aircraft Landing Area) Overlay: All Airport Building Heights (Regulated) Overlay: All Building Near Airfields: All Character Area Overlay: All Character Preservation District: All Coastal Areas: All Future Road Widening: All Hazards (Acid Sulfate Soils): All Hazards (Bushfire – High Risk): All Hazards (Bushfire – Medium Risk): All Hazards (Bushfire – General Risk): All Hazards (Bushfire – Urban Interface): All Hazards (Bushfire – Regional): All Hazards (Flooding): All

Class of Development	Applicable Policies			
	Zone	General Development Policies	Subzone (applies only in the area affected by the Subzone)	Overlay (applies only in the area affected by the Overlay)
	<p>The following policies are applicable to the assessment of the identified Class of Development.</p> <p>Policies referred to are Performance Outcome policies, and any associated Designated Performance Features. Relevant Desired Outcomes are not listed, but automatically apply in relation to a Performance Assessed Development.</p> <p>Where a development comprises more than one Class of Development the relevant policies will be taken to be the sum of the applicable policies for each Class of Development.</p>			
	[Rear Boundary Setback]: PO 9.1	Transport, Access and Parking [Movement Systems]: PO 1.4 Infrastructure and Renewable Energy Facilities [Wastewater Services]: PO 12.1, 12.2 Transport, Access and Parking [Vehicle Access]: PO 3.1, 3.5, 3.6 Transport, Access and Parking [Vehicle Parking Rates]: PO 5.1 Transport, Access and Parking [Vehicle Parking Areas]: PO 6.1, 6.6 Transport, Access and Parking [Bicycle Parking in Designated Areas]: PO 9.1		Historic Area: All Key Outback and Rural Routes Overlay: All Key Railway Crossings Overlay: All Local Heritage Place Overlay: All Major Urban Transport Routes: All Mt Lofty Ranges Catchment (Area 2) Overlay: All Marine Parks (Managed Use) : All Murray Darling Basin : All Native Vegetation : All Noise and Air Emissions: All Non-stop Corridor Overlay: All Ramsar Wetlands Overlay: All River Murray Flood Plain Overlay : All River Murray Tributaries Area Overlay : All Significant Industry Interface Overlay: All Sloping Land Overlay : All State Heritage Area Overlay : All State Heritage Place Overlay : All State Significant Native Vegetation Overlay : All Strategic Infrastructure (Gas Pipelines) Overlay: All Traffic Generating Development Overlay : All Urban Transport Routes Overlay : All Water Protection Area Overlay : All Water Resources Overlay: All
Demolition of a State or Local Heritage Place	None	None	None	Local Heritage Place: All State Heritage Place: All
Demolition within an Historic Areas Overlay area or State Heritage Area	None	None	None	Historic Areas: All State Heritage Area: All
Dwelling addition	[Land Use and Intensity]: PO 1.2 [Site Coverage]: PO 3.1 [Building Height]: PO 4.1	Clearance from Overhead Powerlines: PO 1.1 Infrastructure and Renewable Energy Facilities [Water Supply]: PO 11.2 Infrastructure and Renewable Energy Facilities [Wastewater Services]: PO 12.1, 12.2		Aircraft Noise Exposure Overlay: All Airport Building Heights (Aircraft Landing Area) Overlay: All Airport Building Heights (Regulated) Overlay: All Building Near Airfields: All Building Near Airfields: All Character Area Overlay: All Character Preservation District: All

Class of Development	Applicable Policies			
	Zone	General Development Policies	Subzone (applies only in the area affected by the Subzone)	Overlay (applies only in the area affected by the Overlay)
	<p>The following policies are applicable to the assessment of the identified Class of Development.</p> <p>Policies referred to are Performance Outcome policies, and any associated Designated Performance Features. Relevant Desired Outcomes are not listed, but automatically apply in relation to a Performance Assessed Development.</p> <p>Where a development comprises more than one Class of Development the relevant policies will be taken to be the sum of the applicable policies for each Class of Development.</p>			
	<p>[Primary Street Setback]: PO 5.1 [Secondary Street Setback]: PO 6.1 [Boundary Walls]: PO 7.1, 7.2 [Side Boundary Setback]: PO 8.1 [Rear Boundary Setback]: PO 9.1</p>	<p>Design in Urban Areas [All Residential Development – External Appearance]: PO 14.1</p> <p>Design in Urban Areas [All Residential Development – Outlook and Amenity]: PO 15.1</p> <p>Design in Urban Areas [All Residential Development – 3 Building Levels or Less – External Appearance]: PO 19.1, 19.2, 19.3</p> <p>Design in Urban Areas [All Residential Development – 3 Building Levels or Less –Overlooking / Visual Privacy]: PO 20.1</p> <p>Design in Urban Areas [All Residential Development – 3 Building Levels or Less –Private Open Space]: PO 21.1, 21.2</p> <p>Design in Urban Areas [All Residential Development – 3 Building Levels or Less –Landscaping]: PO 22.1, 22.2</p> <p>Design in Urban Areas [All Residential Development – 3 Building Levels or Less – Waste Storage]: PO 25.1</p> <p>Interface Between Land Uses [Overshadowing]: PO 3.1, 3.2</p> <p>Interface Between Land Uses [Activities Generating Noise or Vibration]: PO 4.4</p> <p>Site Contamination: PO 1.1</p>		<p>Coastal Areas: All</p> <p>Defence Aviation Area Overlay: All Future Road Widening: All</p> <p>Hazards (Acid Sulfate Soils): All Hazards (Bushfire – High Risk): All Hazards (Bushfire – Medium Risk): All Hazards (Bushfire – General Risk): All Hazards (Bushfire – Urban Interface): All Hazards (Bushfire – Regional): All Hazards (Flooding): All Historic Area: All</p> <p>Key Outback and Rural Routes Overlay: All Key Railway Crossings Overlay: All Local Heritage Place Overlay: All Major Urban Transport Routes: All Marine Parks (Managed Use) : All Mt Lofty Ranges Catchment (Area 2) Overlay: All Murray Darling Basin : All Native Vegetation : All Noise and Air Emissions: All Non-stop Corridor Overlay: All Ramsar Wetlands Overlay: All Regulated Trees Overlay: All River Murray Flood Plain Overlay: All River Murray Tributaries Area Overlay: All Significant Industry Interface Overlay: All Sloping Land Overlay: All State Heritage Area Overlay: All State Heritage Place Overlay: All State Significant Native Vegetation Overlay: All Strategic Infrastructure (Gas Pipelines) Overlay: All Traffic Generating Development Overlay: All Urban Transport Routes Overlay: All Water Protection Area Overlay: All Water Resources Overlay: All</p>
Detached dwelling (not being in a Battle-axe arrangement)	[Land Use and Intensity]: PO 1.2	Clearance from Overhead Powerlines: PO 1.1		Aircraft Noise Exposure Overlay: All

Class of Development	Applicable Policies			
	Zone	General Development Policies	Subzone (applies only in the area affected by the Subzone)	Overlay (applies only in the area affected by the Overlay)
Semi-detached dwelling	<p>[Site Dimensions and Land Division]: 2.1, 2.2</p> <p>[Site Coverage]: PO 3.1</p> <p>[Building Height]: PO 4.1</p> <p>[Primary Street Setback]: PO 5.1</p> <p>[Secondary Street Setback]: PO 6.1</p> <p>[Boundary Walls]: PO 7.1, 7.2</p> <p>[Side Boundary Setback]: PO 8.1</p> <p>[Rear Boundary Setback]: PO 9.1</p>	<p>Infrastructure and Renewable Energy Facilities [Water Supply]: PO 11.2</p> <p>Infrastructure and Renewable Energy Facilities [Wastewater Services]: PO 12.1, 12.2</p> <p>Transport, Access and Parking [Vehicle Access]: PO 3.1, 3.5, 3.6</p> <p>Transport, Access and Parking [Vehicle Parking Rates]: PO 5.1</p> <p>Design in Urban Areas [All Development – Car Parking Appearance]: PO 6.1</p> <p>Design in Urban Areas [All Residential Development – External Appearance]: PO 14.1, 14.2</p> <p>Design in Urban Areas [All Residential Development – Outlook and Amenity]: PO 15.1</p> <p>Design in Urban Areas [All Residential Development – Access and Servicing]: PO 16.1</p> <p>Design in Urban Areas [All Residential Development – Flooding]: PO 18.1</p> <p>Design in Urban Areas [All Residential Development – 3 Building Levels or Less – External Appearance]: PO 19.1, 19.2, 19.3</p> <p>Design in Urban Areas [All Residential Development – 3 Building Levels or Less –Overlooking / Visual Privacy]: PO 20.1</p> <p>Design in Urban Areas [All Residential Development – 3 Building Levels or Less –Private Open Space]: PO 21.1, 21.2</p> <p>Design in Urban Areas [All Residential Development – 3 Building Levels or Less –Landscaping]: PO 22.1, 22.2</p>		<p>Airport Building Heights (Aircraft Landing Area) Overlay: All</p> <p>Airport Building Heights (Regulated) Overlay: All</p> <p>Building Near Airfields: All</p> <p>Building Near Airfields: All</p> <p>Character Area Overlay: All</p> <p>Character Preservation District: All</p> <p>Coastal Areas: All</p> <p>Defence Aviation Area Overlay: All</p> <p>Future Road Widening: All</p> <p>Hazards (Acid Sulfate Soils): All</p> <p>Hazards (Bushfire – High Risk): All</p> <p>Hazards (Bushfire – Medium Risk): All</p> <p>Hazards (Bushfire – General Risk): All</p> <p>Hazards (Bushfire – Urban Interface): All</p> <p>Hazards (Bushfire – Regional): All</p> <p>Hazards (Flooding): All</p> <p>Historic Area: All</p> <p>Key Outback and Rural Routes Overlay: All</p> <p>Key Railway Crossings Overlay: All</p> <p>Local Heritage Place Overlay: All</p> <p>Major Urban Transport Routes: All</p> <p>Marine Parks (Managed Use) : All</p> <p>Mt Lofty Ranges Catchment (Area 2) Overlay: All</p> <p>Murray Darling Basin : All</p> <p>Native Vegetation : All</p> <p>Noise and Air Emissions: All</p> <p>Non-stop Corridor Overlay: All</p> <p>Ramsar Wetlands Overlay: All</p> <p>Regulated Trees Overlay: All</p> <p>River Murray Flood Plain Overlay: All</p> <p>River Murray Tributaries Area Overlay: All</p> <p>Significant Industry Interface Overlay: All</p> <p>Sloping Land Overlay: All</p> <p>State Heritage Area Overlay: All</p> <p>State Heritage Place Overlay: All</p> <p>State Significant Native Vegetation Overlay: All</p> <p>Strategic Infrastructure (Gas Pipelines) Overlay: All</p>

Class of Development	Applicable Policies			
	Zone	General Development Policies	Subzone (applies only in the area affected by the Subzone)	Overlay (applies only in the area affected by the Overlay)
		<p>Design in Urban Areas [All Residential Development – 3 Building Levels or Less – Water Sensitive Design]: PO 23.1, 23.2, 23.3</p> <p>Design in Urban Areas [All Residential Development – 3 Building Levels or Less – Car Parking and Manoeuvrability]: PO 24.1, 24.2, 24.3, 24.4, 24.5, 24.6</p> <p>Design in Urban Areas [All Residential Development – 3 Building Levels or Less – Waste Storage]: PO 25.1</p> <p>Interface Between Land Uses [Overshadowing]: PO 3.1, 3.2</p> <p>Interface Between Land Uses [Interface Between Rural Activities]: PO 9.3, 9.4, 9.5</p> <p>Interface Between Land Uses [Interface with Mines and Quarries (Rural and Remote Areas)]: PO 10.1</p> <p>Site Contamination: PO 1.1</p>		<p>Traffic Generating Development Overlay: All</p> <p>Urban Transport Routes Overlay: All</p> <p>Water Protection Area Overlay: All</p> <p>Water Resources Overlay: All</p>
<p>Dwelling, dwellings or residential flat building undertaken by:</p> <p>a) the South Australian Housing Trust either individually or jointly with other persons or bodies; or</p> <p>b) registered Community Housing providers participating in housing renewal programs endorsed by the South Australian Housing Authority</p>		Housing Renewal: All		<p>Aircraft Noise Exposure Overlay: All</p> <p>Airport Building Heights (Aircraft Landing Area) Overlay: All</p> <p>Airport Building Heights (Regulated) Overlay: All</p> <p>Building Near Airfields: All</p> <p>Building Near Airfields: All</p> <p>Character Area Overlay: All</p> <p>Character Preservation District: All</p> <p>Coastal Areas: All</p> <p>Defence Aviation Area Overlay: All</p> <p>Future Road Widening: All</p> <p>Hazards (Acid Sulfate Soils): All</p> <p>Hazards (Bushfire – High Risk): All</p> <p>Hazards (Bushfire – Medium Risk): All</p> <p>Hazards (Bushfire – General Risk): All</p> <p>Hazards (Bushfire – Urban Interface): All</p> <p>Hazards (Bushfire – Regional): All</p> <p>Hazards (Flooding): All</p>

Class of Development	Applicable Policies			
	Zone	General Development Policies	Subzone (applies only in the area affected by the Subzone)	Overlay (applies only in the area affected by the Overlay)
				<p>Historic Area: All</p> <p>Key Outback and Rural Routes Overlay: All</p> <p>Key Railway Crossings Overlay: All</p> <p>Local Heritage Place Overlay: All</p> <p>Major Urban Transport Routes: All</p> <p>Marine Parks (Managed Use) : All</p> <p>Mt Lofty Ranges Catchment (Area 2) Overlay: All</p> <p>Murray Darling Basin : All</p> <p>Native Vegetation : All</p> <p>Noise and Air Emissions: All</p> <p>Non-stop Corridor Overlay: All</p> <p>Ramsar Wetlands Overlay: All</p> <p>Regulated Trees Overlay: All</p> <p>River Murray Flood Plain Overlay: All</p> <p>River Murray Tributaries Area Overlay: All</p> <p>Significant Industry Interface Overlay: All</p> <p>Sloping Land Overlay: All</p> <p>State Heritage Area Overlay: All</p> <p>State Heritage Place Overlay: All</p> <p>State Significant Native Vegetation Overlay: All</p> <p>Strategic Infrastructure (Gas Pipelines) Overlay: All</p> <p>Traffic Generating Development Overlay: All</p> <p>Urban Transport Routes Overlay: All</p> <p>Water Protection Area Overlay: All</p> <p>Water Resources Overlay: All</p>
Excavation and filling		Design in Urban Areas [All Development – Fences and Walls]: PO 8.2		<p>Coastal Areas: All</p> <p>Future Road Widening: All</p> <p>Hazards (Flooding): All</p> <p>Historic Area: All</p> <p>Local Heritage Place: All</p> <p>Major Urban Transport Routes: All</p> <p>Noise and Air Emissions: All</p> <p>Regulated Trees: All</p>

Class of Development	Applicable Policies			
	Zone	General Development Policies	Subzone (applies only in the area affected by the Subzone)	Overlay (applies only in the area affected by the Overlay)
				Sloping Land: All State Heritage Area: All State Heritage Place: All Local Heritage Place Overlay: All Character Area Overlay: All Historic Areas Overlay: All Urban Transport Routes: All Key Outback and Rural Route Overlay All Key Railway Crossings Overlay: All Major Urban Transport Routes: All Mt Lofty Ranges Catchment (Area 2) Overlay: All Native Vegetation Overlay [Environmental Protection]: All State Significant Native Vegetation Areas Overlay: All Future Road Widening Overlay: All Hazards (Acid Sulfate Soils) Overlay: All Non-Stop Corridors Overlay: All Character Preservation District Overlay: All Hazards (Flooding) Overlay: All Coastal Areas Overlay : All River Murray Tributaries Overlay: All River Murray Flood Plain Overlay: All
Fence		Design in Urban Areas [All Development – Fences and Walls]: PO 8.1		Coastal Areas: All Future Road Widening: All

Class of Development

Applicable Policies

The following policies are applicable to the assessment of the identified Class of Development.

Policies referred to are Performance Outcome policies, and any associated Designated Performance Features. Relevant Desired Outcomes are not listed, but automatically apply in relation to a Performance Assessed Development.

Where a development comprises more than one Class of Development the relevant policies will be taken to be the sum of the applicable policies for each Class of Development.

Zone	General Development Policies	Subzone (applies only in the area affected by the Subzone)	Overlay (applies only in the area affected by the Overlay)
-------------	-------------------------------------	--	--

			Hazards (Flooding): All Historic Area: All Local Heritage Place: All Major Urban Transport Routes: All Noise and Air Emissions: All Regulated Trees: All Sloping Land: All State Heritage Area: All State Heritage Place: All Local Heritage Place Overlay: All Character Area Overlay: All Historic Areas Overlay: All Urban Transport Routes: All Key Outback and Rural Route Overlay All Key Railway Crossings Overlay: All Major Urban Transport Routes: All Mt Lofty Ranges Catchment (Area 2) Overlay: All Native Vegetation Overlay [Environmental Protection]: All State Significant Native Vegetation Areas Overlay: All Future Road Widening Overlay: All Hazards (Acid Sulfate Soils) Overlay: All Non-Stop Corridors Overlay: All Character Preservation District Overlay: All Hazards (Flooding) Overlay: All
--	--	--	---

Class of Development	Applicable Policies The following policies are applicable to the assessment of the identified Class of Development. Policies referred to are Performance Outcome policies, and any associated Designated Performance Features. Relevant Desired Outcomes are not listed, but automatically apply in relation to a Performance Assessed Development. Where a development comprises more than one Class of Development the relevant policies will be taken to be the sum of the applicable policies for each Class of Development.			
	Zone	General Development Policies	Subzone (applies only in the area affected by the Subzone)	Overlay (applies only in the area affected by the Overlay)
				Coastal Areas Overlay : All River Murray Tributaries Overlay: All River Murray Flood Plain Overlay: All
Land division	[Site Dimensions and Land Division] PO 2.1, 2.2	Land Division in Urban Areas: All		Affordable Housing Overlay: All Building Near Airfields Overlay : All Character Area Overlay : All Character Preservation District Overlay : All Coastal Areas Overlay : All Environment and Food Production Area Overlay : All Future Road Widening Overlay : All Hazards (Acid Sulfate Soils) Overlay : All Hazards (Bushfire – High Risk) Overlay : All Hazards (Bushfire – Medium Risk) Overlay : All Hazards (Bushfire – General Risk) Overlay : All Hazards (Bushfire – Urban Interface) Overlay : All Hazards (Bushfire – Regional) Overlay : All Hazards (Flooding) Overlay : All Historic Area Overlay : All Key Outback and Rural Routes Overlay : All Key Railway Crossings Overlay : All Local Heritage Place Overlay : All Limited Land Division Overlay: All Major Urban Transport Routes Overlay : All Marine Parks (Managed Use) Overlay : All Murray Darling Basin Overlay : All Native Vegetation Overlay : All Noise and Air Emissions Overlay : All Non-stop Corridor Overlay : All Ramsar Wetlands Overlay : All Regulated Trees Overlay : All River Murray Flood Plain Overlay : All River Murray Tributaries Area Overlay : All Sloping Land Overlay : All State Heritage Area Overlay : All State Heritage Place Overlay : All State Significant Native Vegetation Overlay : All Strategic Infrastructure (Gas Pipelines) Overlay : All

Class of Development	Applicable Policies			
	Zone	General Development Policies	Subzone (applies only in the area affected by the Subzone)	Overlay (applies only in the area affected by the Overlay)
				Traffic Generating Development Overlay : All Urban Transport Routes Overlay : All Water Protection Area Overlay : All Water Resources Overlay: All
Retirement facility Supported accommodation	[Land Use and Intensity] PO 1.2, 1.5 [Site Dimensions and Land Division] PO 2.1 [Site Coverage]: PO 3.1 [Building Height]: PO 4.1 [Primary Street Setback]: PO 5.1 [Secondary Street Setback]: PO 6.1 [Boundary Walls]: PO 7.1, 7.2 [Side Boundary Setback]: PO 8.1 [Rear Boundary Setback]: PO 9.1	Clearance from Overhead Powerlines: PO 1.1 Infrastructure and Renewable Energy Facilities [Water Supply]: PO 11.2 Infrastructure and Renewable Energy Facilities [Wastewater Services]: PO 12.1, 12.2 Transport, Access and Parking [Vehicle Access]: PO 3.1, 3.2, 3.3, 3.4, 3.5, 3.6, 3.8, 3.9 Transport, Access and Parking [Access for People with Disabilities]: All Transport, Access and Parking [Vehicle Parking Rates]: PO 5.1 Transport, Access and Parking [Vehicle Parking Areas]: All Transport, Access and parking [Undercroft and Below Ground Garaging and Parking of Vehicles]: All Design in Urban Areas [All Development]: All Design in Urban Areas [All Residential Development]: All Design in Urban Areas [Residential Development – 3 Building Levels or Less]: All Design in Urban Areas [Group Dwellings, Residential Flat Buildings and Battle-Axe Development]: All Design in Urban Areas [Supported Accommodation, Housing for Aged Persons, and People with Disabilities]: All All Interface Between Land Uses [Overshadowing]: PO 3.1, 3.2		Aircraft Noise Exposure Overlay: All Airport Building Heights (Aircraft Landing Area) Overlay: All Airport Building Heights (Regulated) Overlay: All Building Near Airfields: All Building Near Airfields: All Character Area Overlay: All Character Preservation District: All Coastal Areas: All Defence Aviation Area Overlay: All Future Road Widening: All Hazards (Acid Sulfate Soils): All Hazards (Bushfire – High Risk): All Hazards (Bushfire – Medium Risk): All Hazards (Bushfire – General Risk): All Hazards (Bushfire – Urban Interface): All Hazards (Bushfire – Regional): All Hazards (Flooding): All Historic Area: All Key Outback and Rural Routes Overlay: All Key Railway Crossings Overlay: All Local Heritage Place Overlay: All Major Urban Transport Routes: All Marine Parks (Managed Use) : All Mt Lofty Ranges Catchment (Area 2) Overlay: All Murray Darling Basin : All Native Vegetation : All Noise and Air Emissions: All Non-stop Corridor Overlay: All Ramsar Wetlands Overlay: All Regulated Trees Overlay: All River Murray Flood Plain Overlay: All River Murray Tributaries Area Overlay: All

Class of Development	Applicable Policies			
	Zone	General Development Policies	Subzone (applies only in the area affected by the Subzone)	Overlay (applies only in the area affected by the Overlay)
		<p>Interface Between Land Uses [Activities Generating Noise or Vibration]: PO 4.1, 4.2, 4.4</p> <p>Interface Between Land Uses [Air Quality]: PO 5.2</p> <p>Interface Between Land Uses [Light Spill]: All</p> <p>Site Contamination: PO 1.1</p>		<p>Significant Industry Interface Overlay: All</p> <p>Sloping Land Overlay: All</p> <p>State Heritage Area Overlay: All</p> <p>State Heritage Place Overlay: All</p> <p>State Significant Native Vegetation Overlay: All</p> <p>Strategic Infrastructure (Gas Pipelines) Overlay: All</p> <p>Traffic Generating Development Overlay: All</p> <p>Urban Transport Routes Overlay: All</p> <p>Water Protection Area Overlay: All</p> <p>Water Resources Overlay: All</p>
Shop	<p>[Land Use and Intensity] PO 1.3, 1.4, 1.5, 1.6</p> <p>[Site Coverage]: PO 3.1</p> <p>[Building Height]: PO 4.1</p> <p>[Primary Street Setback]: PO 5.1</p> <p>[Secondary Street Setback]: PO 6.1</p> <p>[Boundary Walls]: PO 7.1, 7.2</p> <p>[Side Boundary Setback]: PO 8.1</p> <p>[Rear Boundary Setback]: PO 9.1</p>	<p>Clearance from Overhead Powerlines: PO 1.1</p> <p>Design in Urban Areas [External Appearance]: PO 1.4</p> <p>Design in Urban Areas [Car Parking Appearance]: PO 6.1, 6.4, 6.5</p> <p>Design in Urban Areas [Water Sensitive Design]: PO 42.1, 42.3</p> <p>Interface Between Land Uses [Hours of Operation]: PO 2.1</p> <p>Interface Between Land Uses [Overshadowing]: PO 3.1, 3.2</p> <p>Transport, Access and Parking [Movement Systems]: PO 1.4</p> <p>Infrastructure and Renewable Energy Facilities [Wastewater Services]: PO 12.1, 12.2</p> <p>Transport, Access and Parking [Vehicle Access]: PO 3.1, 3.5, 3.6</p> <p>Transport, Access and Parking [Vehicle Parking Rates]: PO 5.1</p> <p>Transport, Access and Parking [Vehicle Parking Areas]: PO 6.1, 6.6</p>		<p>Aircraft Noise Exposure Overlay: All</p> <p>Airport Building Heights (Aircraft Landing Area) Overlay: All</p> <p>Airport Building Heights (Regulated) Overlay: All</p> <p>Building Near Airfields: All</p> <p>Building Near Airfields: All</p> <p>Character Area Overlay: All</p> <p>Character Preservation District: All</p> <p>Coastal Areas: All</p> <p>Future Road Widening: All</p> <p>Hazards (Acid Sulfate Soils): All</p> <p>Hazards (Bushfire – High Risk): All</p> <p>Hazards (Bushfire – Medium Risk): All</p> <p>Hazards (Bushfire – General Risk): All</p> <p>Hazards (Bushfire – Urban Interface): All</p> <p>Hazards (Bushfire – Regional): All</p> <p>Hazards (Flooding): All</p> <p>Historic Area: All</p> <p>Key Outback and Rural Routes Overlay: All</p> <p>Key Railway Crossings Overlay: All</p> <p>Local Heritage Place Overlay: All</p> <p>Major Urban Transport Routes: All</p> <p>Marine Parks (Managed Use) : All</p> <p>Mt Lofty Ranges Catchment (Area 2) Overlay: All</p> <p>Murray Darling Basin : All</p> <p>Native Vegetation : All</p> <p>Noise and Air Emissions: All</p>

Class of Development	Applicable Policies			
	Zone	General Development Policies	Subzone (applies only in the area affected by the Subzone)	Overlay (applies only in the area affected by the Overlay)
		Transport, Access and Parking [Bicycle Parking in Designated Areas]: PO 9.1 Interface Between Lands Uses [Air Quality]: PO 5.2		Non-stop Corridor Overlay: All Ramsar Wetlands Overlay : All River Murray Flood Plain Overlay : All River Murray Tributaries Area Overlay : All Significant Industry Interface Overlay: All Sloping Land Overlay : All State Heritage Area Overlay : All State Heritage Place Overlay : All State Significant Native Vegetation Overlay : All Strategic Infrastructure (Gas Pipelines) Overlay: All Traffic Generating Development Overlay : All Urban Transport Routes Overlay : All Water Protection Area Overlay : All Water Resources Overlay: All
Tree damaging activity				Regulated Trees Overlay: All
All other Code Assessed Development				

Table 4 – Restricted Development Classification

Class of Development The following Classes of Development are classified as Restricted subject to any 'Exclusions'	Exclusions
Shop	With a gross leasable area less than 1000m².

Assessment Provisions (AP)

Desired Outcome (DO)

DO 1

Low or very low-density housing that is consistent with the existing local context and development pattern. Services and community facilities will contribute to making the neighbourhood a convenient place to live without compromising residential amenity and character.

DO 2

Development on sloping land that is sensitive to the topography of the area and minimises environmental and visual impacts.

Performance Outcomes and Deemed to Satisfy / Designated Performance Outcome Criteria

Land Use and Intensity

PO 1.1

Residential development and supporting uses that provide housing and supporting services and facilities that preserve a low density residential character.

DTS 1.1

Development comprises one or more of the following land uses:

Community facility

Dwelling

Educational establishment

Office

Pre-school

Recreation area

Shop.

PO 1.2

Dwellings complement the low-density or very-low density character of the neighbourhood.

DTS 1.2

None are applicable.

PO 1.3

Shops, consulting rooms and offices of a scale to maintain the amenity of nearby residents.

DTS 1.3

Other than a change in the use of an existing building that has been lawfully used as a shop, office or consulting room (or any combination thereof), shops, offices and consulting rooms do not exceed 100m² in gross leasable floor area (individually or combined).

PO 1.4

Larger scale shops, offices and consulting rooms established on higher order roads and adjacent existing commercial and retail precincts.

DTS/DPF 1.4

Shop, consulting room and office:

- (a) floor area does not exceed 200m²; and
- (b) are located on sites with a frontage to an arterial or collector road or adjacent a Main Street or Activity Centre Zone.

PO 1.5

Non-residential development located and designed to improve community accessibility to services, primarily in the form of:

- (c) commercial uses including small scale offices, personal and domestic services and consulting rooms;
- (d) community services such as educational establishments, community centres, places of worship, pre-schools, childcare and other health and welfare services;
- (e) services and facilities ancillary to the function or operation of supported accommodation or retirement facilities;
- (f) open space and recreation facilities.

DTS 1.5

None are applicable

PO 1.6

Non-residential development compatible with the low density suburban character and amenity.

DTS 1.6

None are applicable

Site Dimensions and Land Division

PO 2.1

Allotments/sites created for residential purposes are of suitable size and dimension and are compatible with the housing pattern consistent to the locality.

DTS/DPF 2.1

Where the allotment has a slope less than 12.5% (1-in-8), development accords with the following:

- l) site areas (or allotment areas in the case of land division) not less than the minimum allotment size specified in the *Minimum Allotment Size Technical and Numeric Variation Overlay*; and
- m) site frontages not less than the minimum allotment frontage specified in the *Minimum Allotment Frontage Technical and Numeric Variation Overlay*.

PO 2.2

Allotments/sites created for residential purposes are of suitable size and dimension to accommodate residential development that is sensitive to the topography of the locality.

DTS/DPF 2.2

Where the allotment has a slope equal to or greater than 12.5% (1-in-8), development accords with the greater of the following:

- (a) the site areas and site frontages specified in DTS/DPF 2.1; or

(b) the site areas and site frontages specified below:

Development Type	Gradient	Minimum Site Area (m ²)	Minimum Frontage (m)
All Dwelling Types	> 1:8 & < 1:4	1000	15
	≥ 1:4	1500	20

Site coverage

PO 3.1

Building footprints consistent with the character and pattern of a low-density suburban neighbourhood and provide sufficient space around buildings to limit visual impact, provide an attractive outlook and access to light and ventilation.

DTS / DPF 3.1

The development does not result in a total roofed area (excluding eaves of a dwelling) on the site exceeding 50%.

Building Height

PO 4.1

Buildings contribute to a low-rise suburban character and complement the height of nearby buildings.

DTS/DPF 4.1

Building height (excluding garages, carports and outbuildings) no greater than that specified in the *Building Height Technical and Numeric Variations Overlay*.

Primary Street Setback

PO 5.1

Buildings are setback from primary street boundaries to complement the existing suburban streetscape character.

DTS/DPF 4.1

Buildings are setback from the primary street boundary either:

- (a) at least the average of existing buildings on the adjoining sites which face the same street; or
- (b) in relation to a site on the corner of two streets or adjacent a public space or thoroughfare, at least the distance of existing buildings on the adjacent site or the closest site away from the corner, public space or thoroughfare that contains a building facing the same primary street without crossing another street, public space or thoroughfare; or
- (c) at least 8m where no buildings exist on the adjoining or adjacent sites.

Secondary Street Setback

PO 6.1

Buildings are set back from secondary street boundaries to maintain a pattern of separation between buildings and public streets and reinforce streetscape character.

DTS/DPF 6.1

Buildings are set back at least 900mm from the boundary of the allotment with the secondary street frontage, or if a dwelling on any adjoining allotment is closer to the secondary street than 900 millimetres, the distance of that dwelling from the boundary with the secondary street (being, if relevant, the lesser of the 2 distances).

Boundary Walls

PO 7.1

Boundary walls are limited in height and length to manage impacts on adjoining properties.

DTS/DPF 7.1

Except where the dwelling is located on a central site within a row dwelling or terrace arrangement, dwellings with side boundary walls are sited on only one side boundary, and either:

- (a) adjoin or abut a boundary wall of a building on adjoining land for the same length and height; or
- (b) do not exceed the following:
 - (i) 3m in height from the top of the footings;
 - (ii) 10m in length;
 - (iii) when combined with other walls on the boundary of the subject development site, maximum 45% of the length of the boundary; and
 - (iv) setback at least 3 metres from any other existing or proposed boundary walls on the subject land.

PO 7.2

Dwellings in a semi-detached, row or terrace arrangement maintain space between buildings consistent with a low density suburban streetscape character.

DTS / DPF 7.2

Dwellings in a semi-detached, row or terrace arrangement are setback from side boundaries shared with allotments outside the development site at least the minimum distance identified in DTS / DPF 6.1.

Side Boundary Setback

PO 8.1

Buildings are set back from side boundaries to provide:

- (a) separation between dwellings in a way that complements the established character of the locality; and
- (b) access to natural light and ventilation for neighbours.

DTS/DPF 8.1

Buildings are setback from the side boundary at least:

- A. On sites greater than 800m²:
 - (i) Other than a wall facing a southern boundary 1900mm
 - (ii) At least 1900mm plus a 1/3 of the wall height above 3m measured from the top of the footings for walls facing a southern boundary
- B. On sites less than 800m², and other than walls located on a side boundary:
 - (i) at least 900mm where the wall is up to 3m measured from the top of the footings;

- (ii) other than for a wall facing a southern side boundary, at least 900mm plus 1/3 of the wall height above 3m measured from the top of the footings; and
- (iii) at least 1900mm plus 1/3 of the wall height above 3m measured from the top of the footings for walls facing a southern side boundary.

Rear Boundary Setback

PO 9.1

Buildings are set back from rear boundaries to provide:

- (a) separation between dwellings in a way that complements the established character of the locality;
- (b) access to natural light and ventilation for neighbours;
- (c) private opens space; and
- (d) space for landscaping and vegetation.

DTS/DPF 9.1

Buildings are set back from the rear boundary at least:

- (a) 3m for the first building level; and
- (b) 5m for any second building level.

Procedural Matters (PM)

Notification

All classes of performance assessed development are excluded from notification except where they involve any of the following:

- (a) the site of the development is adjacent land to land in a different zone
- (b) development identified as "all other code assessed development" in Suburban Neighbourhood (Low Density) Zone Table 3;
- (c) development involving the creation of four or more additional dwellings or allotments; or
- (d) development exceed the height specified in DTS / DPF 4.1.

Part 3 – Overlays

Advertising Near Signalised Intersections Overlay

Assessment Provisions (AP)

Desired Outcomes (DO)

DO 1

Provision of a safe road environment by reducing driver distraction at key points of conflict on the road.

Performance Outcomes and Deemed to Satisfy / Designated Performance Outcome Criteria

Advertisements Near Signalised Intersections

PO 1.1

Advertising near signalised intersections does not cause unreasonable distraction to road users through excessive size or illumination.

DTS/DPF 1.1

None are applicable.

Procedural Matters (PM)

Referrals		
Class of Development / Activity	Referral Body	Purpose of Referral
Development includes an advertisement or advertising hoarding; that: a) is within 100m of a: (i) signalised intersection; or (ii) signalised pedestrian crossing; and b) will: (i) be internally illuminated; (ii) incorporate a moving or changing display or message; or (iii) incorporate a flashing light.	Commissioner of Highways	To provide expert technical assessment on potential risks relating to pedestrian and road safety which may arise from advertisements near intersections.

Building Near Airfields Overlay

Assessment Provisions (AP)

Desired Outcome (DO)

DO 1

Management of lighting and bird attraction impacts on the operational and safety requirements of certified commercial and military airfields, airports, airstrips and helicopter landing sites.

Performance Outcomes and Deemed to Satisfy / Designated Performance Outcome Criteria

PO 1.1

Outdoor lighting does not pose a hazard to commercial or military aircraft operations.

DTS/DPF 1.1

Development does not include outdoor floodlighting

PO 1.2

Development likely to attract birds adequately separated from airfields to minimise the potential for aircraft bird strike.

DTS/DPF 1.2

Development incorporating one or more of the following land uses is located not less than 3km from the boundaries of an airport used by commercial or military aircraft:

- a. food packing/processing plant;
- b. horticulture;
- c. intensive animal husbandry;
- d. showground;
- e. waste management facility;
- f. waste transfer station;
- g. wetland; or
- h. wildlife sanctuary.

PO 1.3

Buildings and structures that are sensitive to aircraft noise designed to minimise aircraft noise intrusion and provide appropriate interior amenity.

DTS/DPF 1.3

None are applicable

Procedural Matters

Referrals		
Class of Development / Activity	Referral Body	Purpose of Referral
None	None	None

Coastal Areas Overlay

Assessment Provisions (AP)

Desired Outcomes (DO)

DO 1

Conservation and enhancement of the natural coastal environment, provision for natural coastal processes and recognition of current and future coastal hazards including sea level rise, flooding erosion and dune drift to avoid the need, now or in the future, for public expenditure on protection of the environment and development.

Performance Outcomes and Deemed to Satisfy / Designated Performance Outcome Criteria

Land Division

PO 1.1

Land divided only if it or the subsequent development and use of the land will not adversely affect environmental values or the ability of the land or adjoining land to adapt to changing coastal processes.

DTS/DPF 1.1

Land division for minor adjustment of allotment boundaries to remove an anomaly in the current boundaries with respect to the location of existing buildings or structures.

PO 1.2

Land is not divided unless a layout is achieved whereby roads, parking areas and development sites for each allotment are at least 0.3m above the standard sea flood risk level, unless the land is, or can be provided with appropriate and acceptable coastal protection measures.

DTS/DPF 1.2

None are applicable.

PO 1.3

Other than small-scale infill land division in a predominantly urban zone, land division adjacent to the coast incorporates an existing or proposed public reserve (not including a road or erosion buffer) of a size adequate to provide for natural coastal processes, public access and recreation.

DTS/DPF 1.3

None are applicable.

Hazard Risk Minimisation

PO 2.1

Buildings sited over tidal water, or that are not capable of being raised or protected by flood protection measures in the future, are protected against the standard sea flood risk level and sea level rise.

DTS/DPF 2.1

Building floor levels are at least 1.25m above the standard sea flood risk level.

PO 2.2

Development, including associated roads and parking areas, but not minor structures unlikely to be adversely affected by flooding, protected from the standard sea flood risk level and sea level rise.

DTS/DPF 2.2

Development:

- (a) site levels are 0.3m or more above the standard sea flood risk level;
- (b) building floor levels are 0.55m or more above the standard sea flood risk level; and
- (c) practical measures to provide protection against an additional sea level rise of 0.7m plus an allowance to accommodate 100 years of land subsidence are incorporated.

PO 2.3

Development will not create or aggravate coastal erosion or require coast protection works that cause or aggravate coastal erosion.

DTS/DPF 2.3

None are applicable.

PO 2.4

Development set back a sufficient distance from the coast to provide an erosion buffer in addition to a public reserve that will allow for at least 100 years of coastal retreat for single buildings or small-scale developments, or 200 years of coastal retreat for large scale developments unless:

- (a) the development incorporates appropriate private coastal protection measures to protect it from anticipated erosion; or
- (b) there are formal commitments to protect the existing or proposed public reserve and development from anticipated coastal erosion.

DTS/DPF 2.4

None are applicable.

PO 2.5

Additions or alterations to or replacement of an existing dwelling does not increase the risk of effects from natural coastal processes such as flooding, sea-level rise, sand drift and erosion.

DTS/DPF 2.5

None are applicable.

Coast Protection Works

PO 3.1

Development avoids the need for coast protection works through measures such as setbacks to protect development from coastal erosion, sea or stormwater flooding, sand drift or other coastal processes.

DTS 3.1

None are applicable.

PO 3.2

Development does not compromise the structural integrity of any sea wall or levee bank or the ability to maintain, modify or upgrade any sea wall or levee bank.

DTS/DPF 3.2

None are applicable.

PO 3.3

Unavoidable coast protection works are the subject of binding agreements to cover the cost of future construction, operation, maintenance and management measures and will not:

- (a) have an adverse effect on coastal ecology, processes, conservation, public access and amenity;
- (b) require commitment of public resources including land; and

(c) present an unacceptable risk of failure relative to potential hazard resulting from failure.

DTS/DPF 3.3

None are applicable.

Environment Protection

PO 4.1

Development will not unreasonably affect the marine and onshore coastal environment by pollution, erosion, damage or depletion of physical or biological resources, interference with natural coastal processes, introduction of and spread of marine pests or any other means.

DTS/DPF 4.1

None are applicable.

PO 4.2

Development avoids delicate or environmentally-sensitive coastal areas such as sand dunes, cliff tops, estuaries, wetlands or substantially intact strata of native vegetation.

DTS/DPF 4.2

None are applicable.

PO 4.3

Development allows for ecological and natural landform adjustment to changing climatic conditions and sea levels, by allowing landward migration of dunes, coastal wetlands, mangrove and samphire areas.

DTS/DPF 4.3

None are applicable.

PO 4.4

Development avoids, or in built up areas minimises, impacts on important habitat areas that support the nesting, breeding and movement/migration patterns of fauna, including threatened shorebirds.

DTS/DPF 4.4

None are applicable.

PO 4.5

Development designed so that solid and fluid wastes and stormwater runoff are disposed of in a manner that avoids pollution or other detrimental impacts on the marine and on-shore environment of coastal areas.

DTS/DPF 4.5

None are applicable.

PO 4.6

Development involving the removal of shell grit, cobbles or sand, other than for coastal protection works purposes, is not undertaken.

DTS/DPF 4.6

Development does not involve the removal of shell grit or sand.

Access

PO 5.1

Development maintains or enhances appropriate public access to and along the foreshore.

DTS/DPF 5.1

None are applicable.

PO 5.2

Public access through sensitive coastal landforms, particularly sand dunes, wetlands and cliffs, is restricted to defined pedestrian paths and constructed to minimise adverse environmental impact.

DTS/DPF 5.2

None are applicable.

PO 5.3

Access roads to the coast, lookouts and places of interest:

- (a) do not detract from the amenity or the environment;
- (b) are designed for slow moving traffic; and
- (c) are minimised in number.

DTS/DPF 5.3

None are applicable.

PO 5.4

Development on land adjoining a coastal reserve should be sited and designed to be compatible with the purpose, management and amenity of the reserve, as well as to prevent inappropriate access to or use of the reserve.

DTS/DPF 5.4

None are applicable.

Procedural Matters (PM)

Referrals		
Class of Development / Activity	Referral Body	Purpose of Referral
<p>Except where the development is in the opinion of the relevant authority minor in nature and would not warrant a referral when considering the purpose of the referral, the following:</p> <ul style="list-style-type: none">(a) excavation or filling where the total volume of material excavated or filled exceeds 9m³;(b) dwellings and habitable buildings that<ul style="list-style-type: none">(i) do not meet site and building floor level requirements set out in the Coastal Areas Overlay; or(ii) are within 100m of the mean high water mark;(c) other than within a Settlement Zone:	Coast Protection Board	<p>To provide expert assessment and direction to the relevant authority on:</p> <ul style="list-style-type: none">• the risk to development from current and future coastal hazards (including sea-level rise, coastal flooding, erosion, dune drift and acid sulfate soils);• coast protection works;• potential impacts from development on public access and the coastal environment

Referrals		
Class of Development / Activity	Referral Body	Purpose of Referral
(i) buildings with a floor area greater than 60m ² ; (ii) tourist accommodation, including a caravan park; or (iii) development that involves a division of land that would create 1 or more additional allotments; (d) off shore structures; (e) coast protection works; or (f) infrastructure within 100m landward of the mean high water mark.		(including important coastal features).

Hazards (Bushfire – Outback) Overlay

Assessment Provisions (AP)

Desired Outcomes (DO)

DO 1

Development is located to minimise the threat and impact of bushfires on life and property.

DO 2

To facilitate access for emergency service vehicles to protect assets and lives from bushfire danger.

Performance Outcomes and Deemed to Satisfy / Designated Performance Outcome Criteria

Habitable Buildings

PO 1.1

Residential and tourist accommodation (including boarding houses, hostels, dormitory style accommodation, student accommodation and workers accommodation):

- (a) are sited to avoid, narrow gullies, steep slopes (especially slopes with a northerly or westerly aspect) and vegetated areas (including unmanaged grasslands) that pose an unacceptable bushfire risk; and
- (b) minimise the need to clear native vegetation.

DTS/DPF 1.1

Development meets the following requirements:

- (a) an asset protection zone with a minimum width of 50m already exists and can continue to be maintained around the accommodation; and
- (b) the asset protection zone is contained wholly within the allotment of the development.

Vehicle Access –Roads and Driveways

PO 2.1

Roads are designed and constructed to:

- (a) facilitate the safe and effective:

- i. use, operation and evacuation of fire-fighting and emergency personnel; and
 - ii. evacuation of residents; and
- (b) avoid the unnecessary clearance of native vegetation

DTS/DPF 2.1

Roads:

- (a) do not require the clearance of native vegetation;
- (b) are constructed with a formed, all-weather surface;
- (c) have a gradient of not more than 16 degrees (1-in-3.5) at any point along the road;
- (d) have a cross fall of not more than 6 degrees (1-in-9.5) at any point along the road;
- (e) have a minimum formed road width of 6m;
- (f) provide overhead clearance of not less than 4.0m between the road surface and overhanging branches or other obstructions including buildings and/or structures (Figure 2);
- (g) allow fire-fighting services (personnel and vehicles) to travel in a continuous forward movement around road curves by constructing the curves with a minimum external radius of 12.5m (Figure 3);
- (h) incorporating use of cul-de-sac endings or dead end roads to not exceed 200m in length and the end of the road to have either:
 - a. a turning area with a minimum formed surface radius of 12.5m (Figure 4); or
 - b. a 'T' or 'Y' shaped turning area with a minimum formed surface length of 11m and minimum internal radii of 9.5m (Figure 5); and
- (i) incorporate solid, all-weather crossings that support fire-fighting vehicles with a gross vehicle mass (GVM) of 21 tonnes, over any watercourse.

PO 2.2

Where the furthest point of the building from the nearest public road is greater than 30m, driveways are designed and constructed to:

- (a) facilitate the safe and effective:
 - i. use, operation and evacuation of fire-fighting and emergency personnel; and
 - ii. evacuation of residents; and
- (b) avoid the unnecessary clearance of native vegetation.

DTS/DPF 2.2

Driveways:

- (a) do not require the clearance of native vegetation;
- (b) do not exceed 600m in length;
- (c) are constructed with a formed, all-weather surface;
- (d) are connected to a formed, all-weather public road with the transition area between the road and driveway having a gradient of not more than 7 degrees (1-in-8);
- (e) have a gradient of not more than 16 degrees (1-in-3.5) at any point along the driveway;
- (f) have a cross fall of not more than 6 degrees (1-in-9.5) at any point along the driveway;
- (g) have a minimum formed width of 3m (4m where the gradient of the driveway is steeper than 12 degrees (1-in-4.5) plus 0.5 metres clearance either side of the driveway from overhanging branches or other obstructions, including buildings and/or structures (Figure 2);
- (h) incorporate passing bays with a minimum width of 6m and length of 17m every 200m (Figure 6);
- (i) provide overhead clearance of not less than 4.0m between the driveway surface and overhanging branches or other obstructions, including buildings and/or structures (Figure 2);
- (j) allow fire-fighting services (personnel and vehicles) to travel in a continuous forward movement around driveway curves by constructing the curves with a minimum external radius of 12.5m (Figure 3);

- (k) allow fire-fighting vehicles to safely enter and exit an allotment in a forward direction by incorporating at the end of the driveway either:
 - i. a loop road around the building; or
 - ii. a turning area with a minimum radius of 12.5m (Figure 4); or
 - iii. 'T' or 'Y' shaped turning area with a minimum formed length of 11m and minimum internal radii of 9.5m (Figure 5).
- (l) incorporate solid, all-weather crossings that support fire-fighting vehicles with a gross vehicle mass (GVM) of 21 tonnes, over any watercourse.

Procedural Matters (PM)

Referrals		
Class of Development / Activity	Referral Body	Purpose of Referral
None	None	None

Figures and Diagrams

Fire Appliance Clearances

Figure 1 – Overhead and Side Clearances

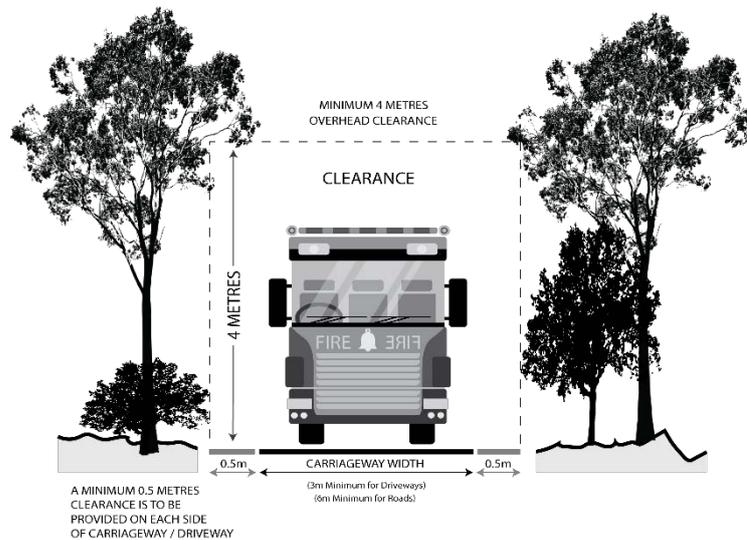

Roads and Driveway Design

Figure 2 - Road and Driveway Curves

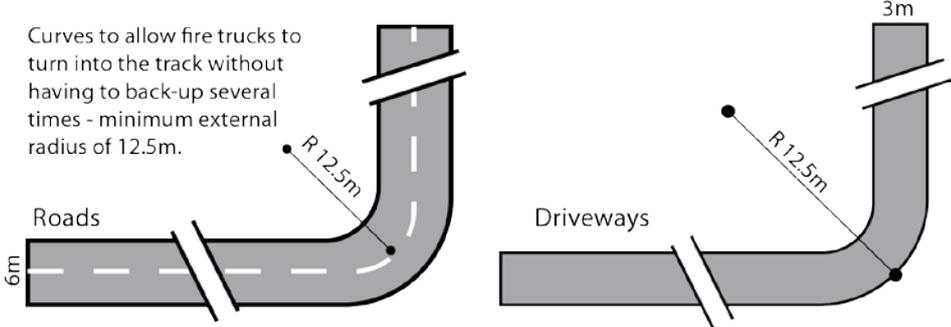

Figure 3 – Full Circle Turning Area

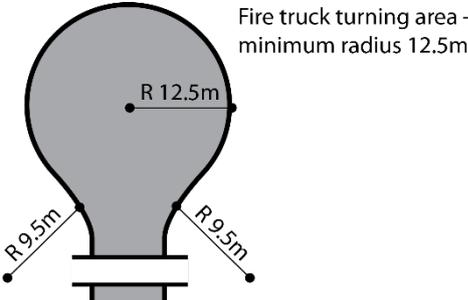

Figure 4 - 'T' or 'Y' Shaped Turning Head

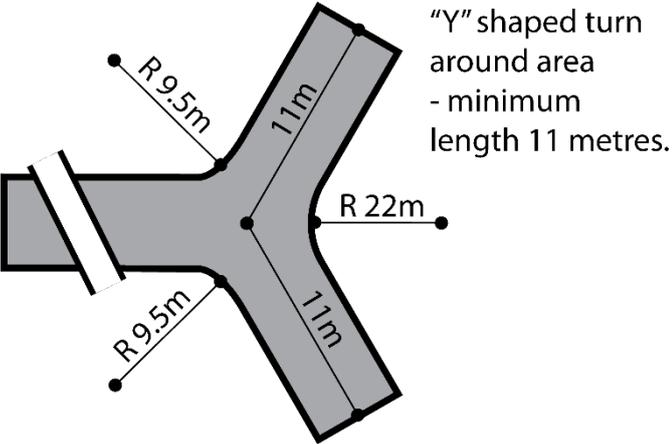
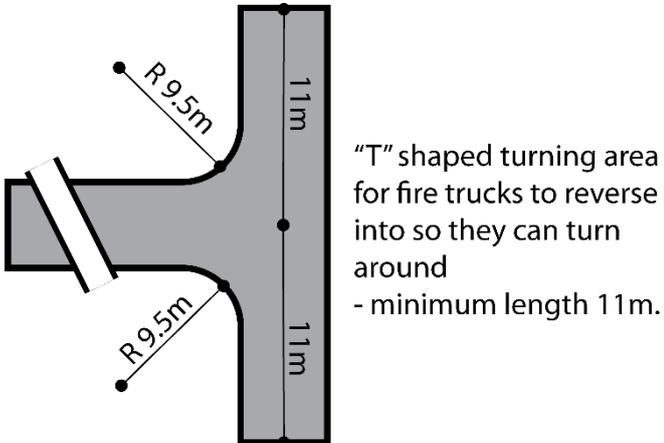
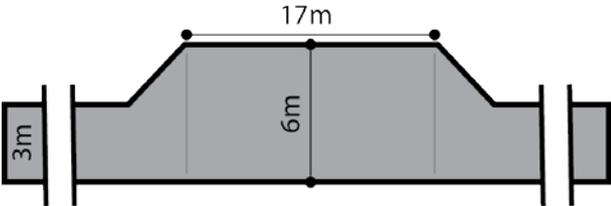

Figure 5 - Driveway Passing Bays

Passing bay for fire trucks - minimum width 6 metres, minimum length 17 metres.



Hazards (Bushfire – Regional) Overlay

Assessment Provisions (AP)

Desired Outcomes (DO)

DO 1

Development is located to minimise the threat and impact of bushfires on life and property.

DO 2

To facilitate access for emergency service vehicles to protect assets and lives from bushfire danger.

Performance Outcomes and Deemed to Satisfy / Designated Performance Outcome Criteria

Siting

PO 1.1

Buildings and structures are located away from areas that pose an unacceptable bushfire risk as a result of:

- (a) vegetation cover comprising trees and/or shrubs and/or unmanaged grasslands;
- (b) poor access;
- (c) rugged terrain;
- (d) isolated location (e.g. more than 600m from a public road);
- (e) inability to provide an adequate asset protection zone; and/or
- (f) inability to provide a suitable site for an adequate supply of water for firefighting purposes.

DTS/DPF 1.1

None are applicable

Built Form

PO 2.1

Buildings and structures are designed and configured to reduce the impact of bushfire through using designs that reduce the potential for trapping burning debris against or underneath the building or structure, or between the ground and building floor level in the case of transportable buildings and buildings on stilts

DTS/DPF 2.1

None are applicable

PO 2.2

Extensions to existing buildings, outbuildings and other ancillary structures are sited and constructed using materials to minimise the threat of fire spread to residential and tourist accommodation (including boarding houses, hostels, dormitory style accommodation, student accommodation and workers accommodation) in the event of bushfire.

DTS/DPF 2.2

None are applicable

Habitable Buildings

PO 3.1

To minimise the threat, impact and exposure to bushfires on life and property, residential and tourist accommodation (including boarding houses, hostels, dormitory style accommodation, student accommodation and workers accommodation) are sited on the flatter portion of allotments and avoid steep slopes, especially:

- (a) upper slopes;
- (b) narrow ridge crests and the tops of narrow gullies; and
- (c) slopes with a northerly or westerly aspect.

DTS/DPF 3.1

None are applicable

PO 3.2

Residential and tourist accommodation (including boarding houses, hostels, dormitory style accommodation, student accommodation and workers accommodation):

- (a) are sited away from vegetated areas that pose an unacceptable bushfire risk; and
- (b) minimise the need to clear native vegetation.

DTS/DPF 3.2

Development meets the following requirements:

- (a) an asset protection zone with a minimum width of 50m already exists and can continue to be maintained around the accommodation; and
- (b) the asset protection zone is contained wholly within the allotment of the development.

PO 3.3

Residential and tourist accommodation (including boarding houses, hostels, dormitory style accommodation, student accommodation and workers accommodation) have a dedicated and accessible water supply available at all times for fire-fighting purposes.

DTS/DPF 3.3

Development has a dedicated water supply available at all times for fire-fighting purposes:

- (a) comprising a minimum of 5000 litres; and
- (b) positioned in an accessible location and accompanied with necessary equipment to allow occupants to minimise the spread of bushfire to the accommodation.

Land Division

PO 4.1

Land division is designed to:

- (a) minimise fire risk danger to residents, other occupants of buildings and firefighting personnel;
- (b) minimise the potential risk of damage to buildings and other property during a bushfire; and
- (c) ensure each allotment contains a suitable building envelope that is located away from any vegetation that would pose an unacceptable risk in the event of bushfire.

DTS/DPF 4.1

None are applicable

PO 4.2

Land division designed in accordance with Figure 1 to:

- (a) facilitate the movement of emergency vehicles through, within and out of bushfire risk areas;
- (b) provide a mainly continuous street pattern serving new allotments that eliminates the use of cul-de-sacs or dead end roads. Where cul-de-sacs/dead end roads are proposed an alternative emergency evacuation route is provided;
- (c) facilitate the safe and efficient evacuation of residents, visitors and other personnel during a bushfire event and not rely on fire tracks as means of evacuation; and
- (d) include at least two separate entry/exit points where 10 or more allotments are proposed.

DTS/DPF 4.2

None are applicable

PO 4.3

Land division will ensure provision of a bushfire buffer zone that isolates residential allotments from areas that pose an unacceptable bushfire risk by containing the allotments within a perimeter road and other means such as open parks and sporting areas that achieve adequate separation (Figure 1).

DTS/DPF 4.3

None are applicable

Vehicle Access –Roads and Driveways

PO 5.1

Roads are designed and constructed to:

- (a) facilitate the safe and effective:
 - i. use, operation and evacuation of fire-fighting and emergency personnel; and
 - ii. evacuation of residents; and
- (b) avoid the unnecessary clearance of native vegetation avoid the unnecessary clearance of native vegetation

DTS/DPF 5.1

Roads:

- (a) do not require the clearance of native vegetation;
- (b) are constructed with a formed, all-weather surface;
- (c) have a gradient of not more than 16 degrees (1-in-3.5) at any point along the road;
- (d) have a cross fall of not more than 6 degrees (1-in-9.5) at any point along the road;
- (e) have a minimum formed road width of 6m;
- (f) provide overhead clearance of not less than 4.0m between the road surface and overhanging branches or other obstructions including buildings and/or structures (Figure 2);
- (g) allow fire-fighting services (personnel and vehicles) to travel in a continuous forward movement around road curves by constructing the curves with a minimum external radius of 12.5m (Figure 3);
- (h) incorporating use of cul-de-sac endings or dead end roads to not exceed 200m in length and the end of the road to have either:
 - (i) a turning area with a minimum formed surface radius of 12.5m (Figure 4); or
 - (ii) a 'T' or 'Y' shaped turning area with a minimum formed surface length of 11m and minimum internal radii of 9.5m (Figure 5); and

- (i) incorporate solid, all-weather crossings that support fire-fighting vehicles with a gross vehicle mass (GVM) of 21 tonnes, over any watercourse.

PO 5.2

Where the furthest point of the building from the nearest public road is greater than 30m, driveways are designed and constructed to:

- (a) facilitate the safe and effective:
 - i. use, operation and evacuation of fire-fighting and emergency personnel; and
 - ii. evacuation of residents; and
- (b) avoid the unnecessary clearance of native vegetation

DTS/DPF 5.2

Driveways:

- (a) do not require the clearance of native vegetation;
- (b) do not exceed 600m in length;
- (c) are constructed with a formed, all-weather surface;
- (d) are connected to a formed, all-weather public road with the transition area between the road and driveway having a gradient of not more than 7 degrees (1-in-8);
- (e) have a gradient of not more than 16 degrees (1-in-3.5) at any point along the driveway;
- (f) have a cross fall of not more than 6 degrees (1-in-9.5) at any point along the driveway;
- (g) have a minimum formed width of 3m (4m where the gradient of the driveway is steeper than 12 degrees (1-in-4.5) plus 0.5 metres clearance either side of the driveway from overhanging branches or other obstructions, including buildings and/or structures (Figure 2);
- (h) incorporate passing bays with a minimum width of 6m and length of 17m every 200m (Figure 6);
- (i) provide overhead clearance of not less than 4.0m between the driveway surface and overhanging branches or other obstructions, including buildings and/or structures (Figure 2);
- (j) allow fire-fighting services (personnel and vehicles) to travel in a continuous forward movement around driveway curves by constructing the curves with a minimum external radius of 12.5m (Figure 3);
- (k) allow fire-fighting vehicles to safely enter and exit an allotment in a forward direction by incorporating at the end of the driveway either:
 - i. a loop road around the building; or
 - ii. a turning area with a minimum radius of 12.5m (Figure 4); or
 - iii. a 'T' or 'Y' shaped turning area with a minimum formed length of 11m and minimum internal radii of 9.5m (Figure 5).
- (l) incorporate solid, all-weather crossings that support fire-fighting vehicles with a gross vehicle mass (GVM) of 21 tonnes, over any watercourse.

Procedural Matters (PM)

Referrals		
Class of Development / Activity	Referral Body	Purpose of Referral
None	None	None

Figures and Diagrams

Land Division

Figure 1 – Land Division Layout

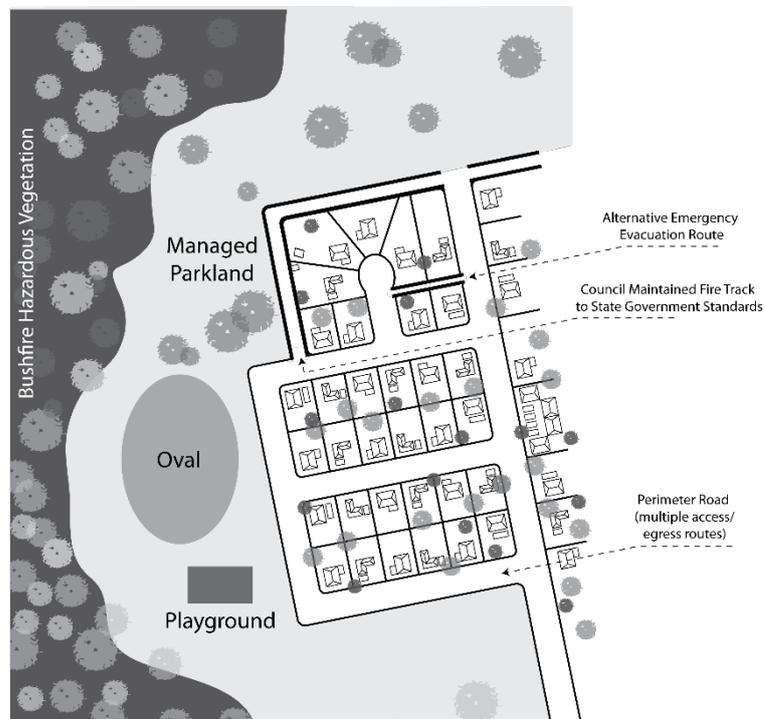

Fire Appliance Clearances

Figure 2 – Overhead and Side Clearances

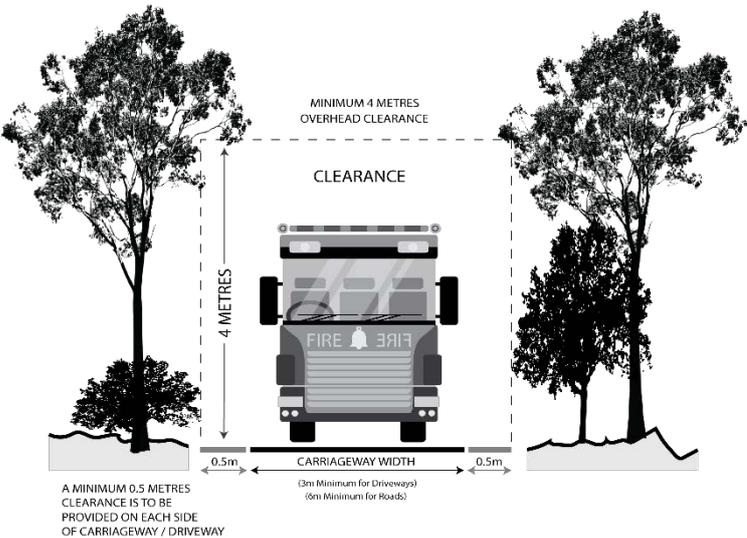

Roads and Driveway Design

Figure 3 - Road and Driveway Curves

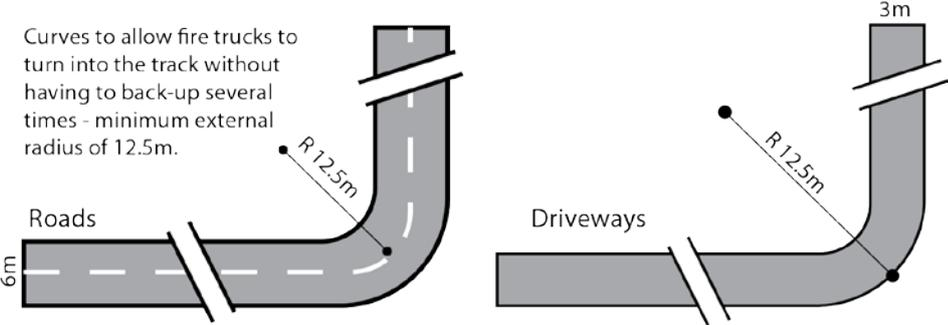

Figure 4 – Full Circle Turning Area

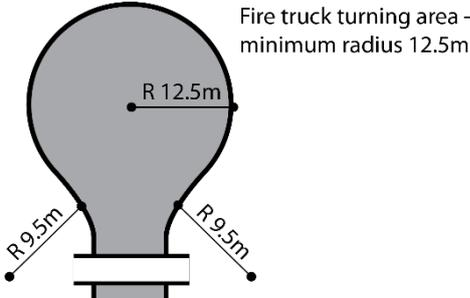

Figure 5 - 'T' or 'Y' Shaped Turning Head

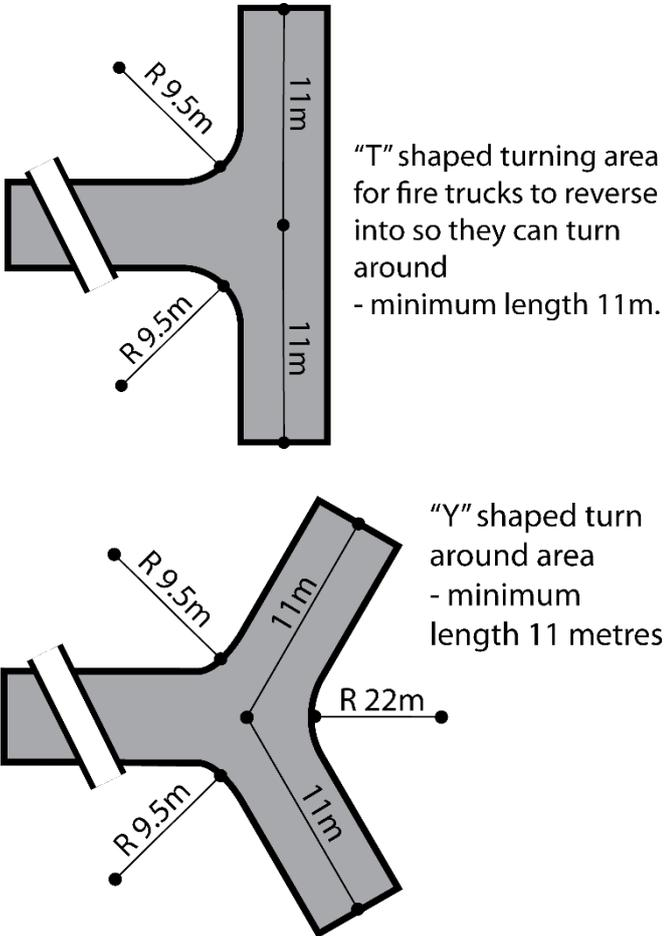
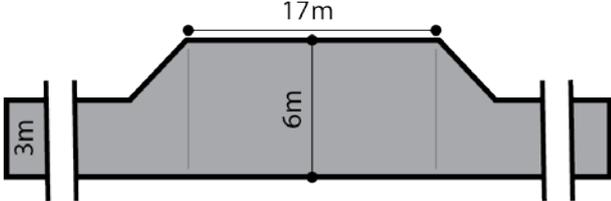

Figure 6 - Driveway Passing Bays

Passing bay for fire trucks - minimum width 6 metres, minimum length 17 metres.



Hazards (Acid Sulfate Soils) Overlay

Assessment Provisions (AP)

Desired Outcomes (DO)

DO 1

Protection of the environment and development from the release of acid water resulting from the disturbance of acid sulfate soils.

Performance Outcomes and Deemed to Satisfy / Designated Performance Outcome Criteria

Land Use and Intensity

PO 1.1

Excavation or change to a water table is managed in a way that effectively avoids potential harm or damage to any of the following from release of acid sulfate soils:

- a. marine and estuarine environments;
- b. natural water bodies and wetlands;
- c. agricultural or aquaculture activities;
- d. buildings, structures and infrastructure; or
- e. public health.

DTS/DPF 1.1

Development does not involve or cause:

- a. excavation of land; or
- b. change to a water table.

Procedural Matters (PM)

Referrals		
Class of Development / Activity	Referral Body	Purpose of Referral
None	None	None

Hazards (Bushfire – General Risk) Overlay

Assessment Provisions (AP)

Desired Outcomes (DO)

DO 1

Development responds to the general level of bushfire risk by siting and designing buildings in a manner that mitigates the threat and impact of bushfires on life and property.

DO 2

To facilitate access for emergency service vehicles to protect assets and lives from bushfire danger.

Performance Outcomes and Deemed to Satisfy / Designated Performance Outcome Criteria

Siting

PO 1.1

Buildings and structures are located away from areas that pose an unacceptable bushfire risk as a result of:

- a. vegetation cover comprising trees and/or shrubs and/or unmanaged grasslands;
- b. poor access;
- c. rugged terrain;
- d. isolated location (e.g. more than 600m from a public road);
- e. inability to provide an adequate asset protection zone; and/or
- f. inability to provide a suitable site for an adequate supply of water for firefighting purposes.

DTS/DPF 1.1

None are applicable.

Built Form

PO 2.1

Buildings and structures are designed and configured to reduce the impact of bushfire through using designs that reduce the potential for trapping burning debris against or underneath the building or structure, or between the ground and building floor level in the case of transportable buildings and buildings on stilts.

DTS/DPF 2.1

None are applicable.

PO 2.2

Extensions to existing buildings, outbuildings and other ancillary structures are sited and constructed using materials to minimise the threat of fire spread to residential and tourist accommodation (including boarding houses, hostels, dormitory style accommodation, student accommodation and workers accommodation) in the event of bushfire.

DTS/DPF 2.2

None are applicable.

Habitable Buildings

PO 3.1

To minimise the threat, impact and exposure to bushfires on life and property, residential and tourist accommodation (including boarding houses, hostels, dormitory style accommodation, student

accommodation and workers accommodation) are sited on the flatter portion of allotments and avoid steep slopes, especially:

- a. upper slopes;
- b. narrow ridge crests and the tops of narrow gullies; and
- c. slopes with a northerly or westerly aspect.

DTS/DPF 3.1

None are applicable.

PO 3.2

Residential and tourist accommodation (including boarding houses, hostels, dormitory style accommodation, student accommodation and workers accommodation):

- a. are sited away from vegetated areas that pose an unacceptable bushfire risk; and
- b. minimise the need to clear native vegetation.

DTS/DPF 3.2

Development meets the following requirements:

- a. an asset protection zone with a minimum width of 50m already exists and can continue to be maintained around the accommodation; and
- b. the asset protection zone is contained wholly within the allotment of the development.

PO 3.3

Residential and tourist accommodation (including boarding houses, hostels, dormitory style accommodation, student accommodation and workers accommodation) have a dedicated area available that is capable of accommodating a bushfire protection system comprising firefighting equipment and water supply in accordance with Ministerial Building Standard SA 008.

DTS/DPF 3.3

None are applicable.

Land Division

PO 4.1

Land division is designed to:

- a. minimise fire risk danger to residents, other occupants of buildings and firefighting personnel;
- b. minimise the potential risk of damage to buildings and other property during a bushfire; and
- c. ensure each allotment contains a suitable building envelope that is located away from any vegetation that would pose an unacceptable risk in the event of bushfire.

DTS/DPF 4.1

None are applicable.

PO 4.2

Land division designed in accordance with Figure 1 to:

- (a) facilitate the movement of emergency vehicles through, within and out of bushfire risk areas;
- (b) provide a mainly continuous street pattern serving new allotments that eliminates the use of cul-de-sacs or dead end roads. Where cul-de-sacs/dead end roads are proposed an alternative emergency evacuation route is provided;

- (c) facilitate the safe and efficient evacuation of residents, visitors and other personnel during a bushfire event and not rely on fire tracks as means of evacuation; and
- (d) include at least two separate entry/exit points where 10 or more allotments are proposed.

DTS/DPF 4.2

None are applicable.

PO 4.3

Land division will ensure provision of a bushfire buffer zone that isolates residential allotments from areas that pose an unacceptable bushfire risk by containing the allotments within a perimeter road and other means such as open parks and sporting areas that achieve adequate separation (Figure 1).

DTS/DPF 4.3

None are applicable.

Vehicle Access –Roads and Driveways

PO 5.1

Roads are designed and constructed to:

- (a) facilitate the safe and effective:
 - i. use, operation and evacuation of fire-fighting and emergency personnel; and
 - ii. evacuation of residents; and
- (b) avoid the unnecessary clearance of native vegetation

DTS/DPF 5.1

Roads:

- (a) do not require the clearance of native vegetation;
- (b) are constructed with a formed, all-weather surface;
- (c) have a gradient of not more than 16 degrees (1-in-3.5) at any point along the road;
- (d) have a cross fall of not more than 6 degrees (1-in-9.5) at any point along the road;
- (e) have a minimum formed road width of 6m;
- (f) provide overhead clearance of not less than 4.0m between the road surface and overhanging branches or other obstructions including buildings and/or structures (Figure 2);
- (g) allow fire-fighting services (personnel and vehicles) to travel in a continuous forward movement around road curves by constructing the curves with a minimum external radius of 12.5m (Figure 3);
- (h) incorporating use of cul-de-sac endings or dead end roads to not exceed 200m in length and the end of the road to have either:
 - i. a turning area with a minimum formed surface radius of 12.5m (Figure 4); or
 - ii. a 'T' or 'Y' shaped turning area with a minimum formed surface length of 11m and minimum internal radii of 9.5m (Figure 5); and
- (i) incorporate solid, all-weather crossings that support fire-fighting vehicles with a gross vehicle mass (GVM) of 21 tonnes, over any watercourse.

PO 5.2

Where the furthest point of the building from the nearest public road is greater than 30m, driveways are designed and constructed to:

- (a) facilitate the safe and effective:
 - i. use, operation and evacuation of fire-fighting and emergency personnel; and
 - ii. evacuation of residents; and
- (b) avoid the unnecessary clearance of native vegetation

DTS/DPF 5.2

Driveways:

- (a) do not require the clearance of native vegetation;
- (b) do not exceed 600m in length;
- (c) are constructed with a formed, all-weather surface;
- (d) are connected to a formed, all-weather public road with the transition area between the road and driveway having a gradient of not more than 7 degrees (1-in-8);
- (e) have a gradient of not more than 16 degrees (1-in-3.5) at any point along the driveway;
- (f) have a cross fall of not more than 6 degrees (1-in-9.5) at any point along the driveway;
- (g) have a minimum formed width of 3m (4m where the gradient of the driveway is steeper than 12 degrees (1-in-4.5) plus 0.5 metres clearance either side of the driveway from overhanging branches or other obstructions, including buildings and/or structures (Figure 2);
- (h) incorporate passing bays with a minimum width of 6m and length of 17m every 200m (Figure 6);
- (i) provide overhead clearance of not less than 4.0m between the driveway surface and overhanging branches or other obstructions, including buildings and/or structures (Figure 2);
- (j) allow fire-fighting services (personnel and vehicles) to travel in a continuous forward movement around driveway curves by constructing the curves with a minimum external radius of 12.5m (Figure 3);
- (k) allow fire-fighting vehicles to safely enter and exit an allotment in a forward direction by incorporating at the end of the driveway either:
 - i. a loop road around the building; or
 - ii. a turning area with a minimum radius of 12.5m (Figure 4); or
 - iii. a 'T' or 'Y' shaped turning area with a minimum formed length of 11m and minimum internal radii of 9.5m (Figure 5).
- (l) incorporate solid, all-weather crossings that support fire-fighting vehicles with a gross vehicle mass (GVM) of 21 tonnes, over any watercourse.

Procedural Matters (PM)

Referrals		
Class of Development / Activity	Referral Body	Purpose of Referral
None	None	None

Figures and Diagrams

Land Division

Figure 1 – Land Division Layout

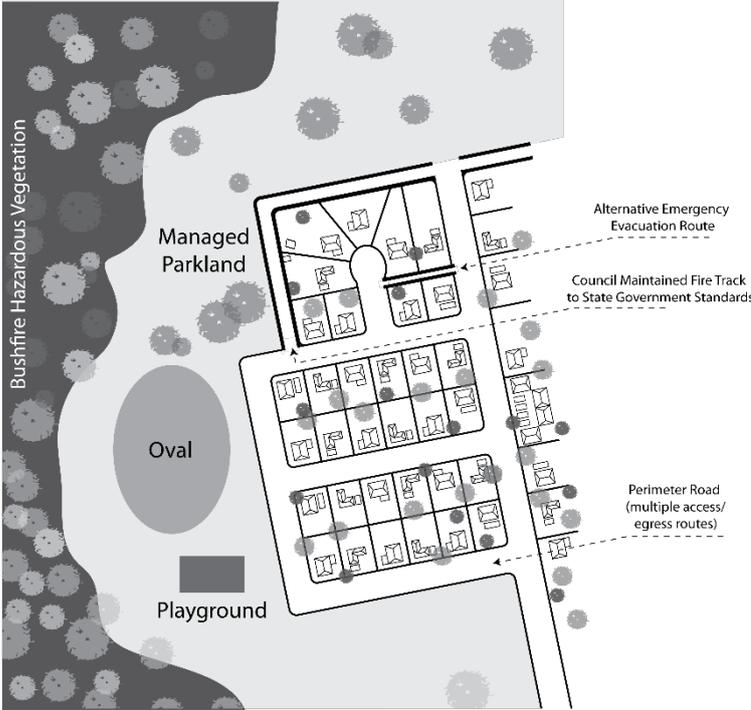

Fire Appliance Clearances

Figure 2 – Overhead and Side Clearances

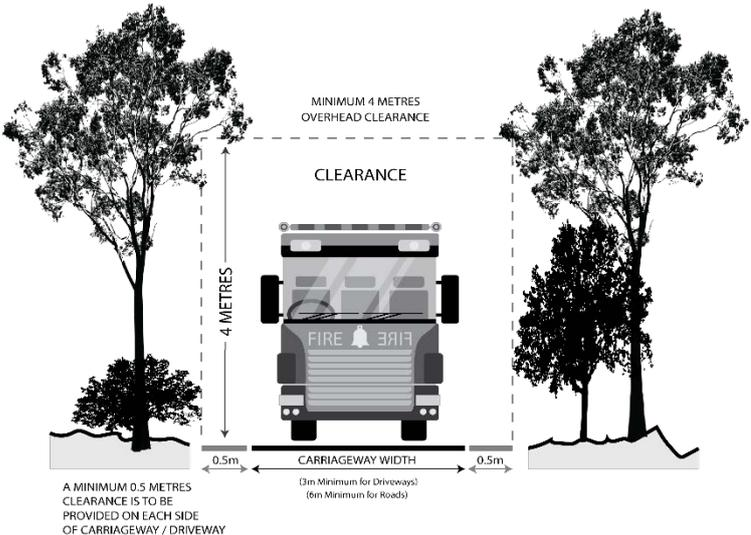

Roads and Driveway Design

Figure 3 - Road and Driveway Curves

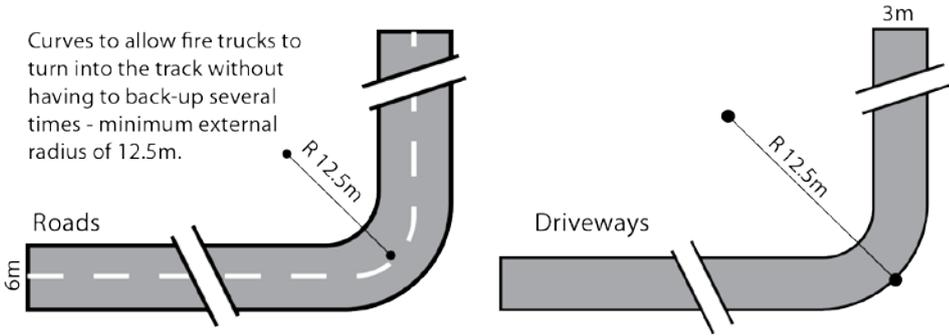

Figure 4 - Full Circle Turning Area

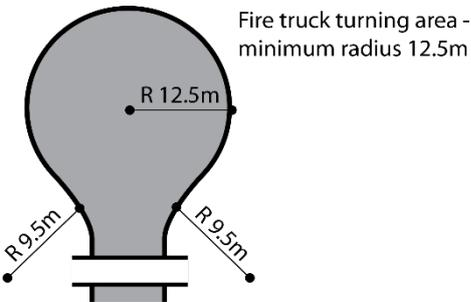

Figure 5 - 'T' or 'Y' Shaped Turning Head

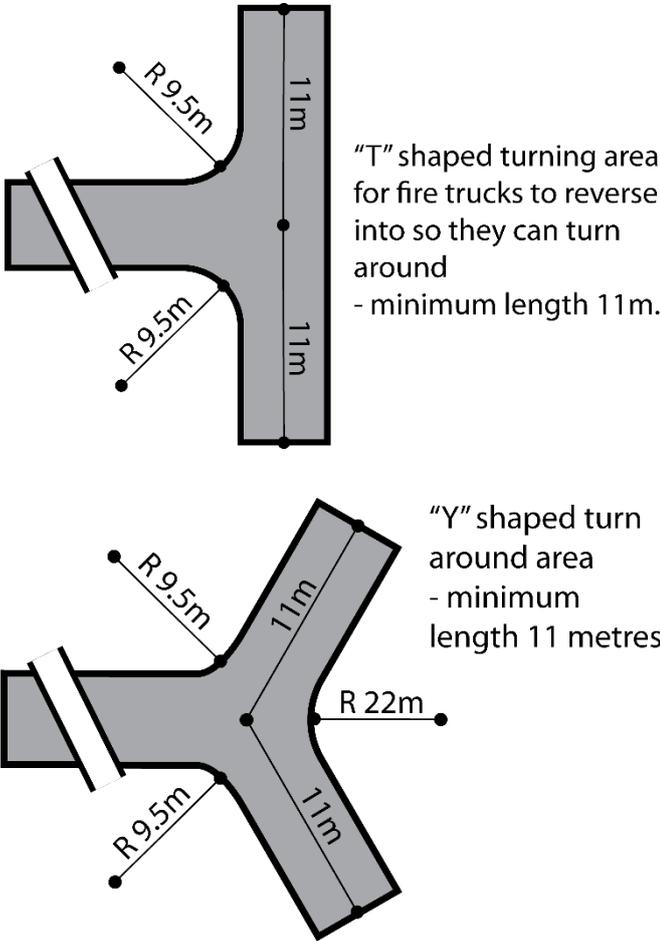
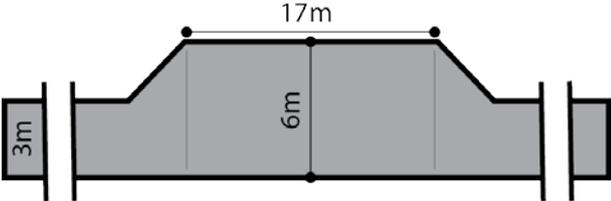

Figure 6 - Driveway Passing Bays

Passing bay for fire trucks - minimum width 6 metres, minimum length 17 metres.



Hazards (Bushfire – High Risk) Overlay

Assessment Provisions (AP)

Desired Outcomes (DO)

DO 1

Development will be sited and designed to minimise the threat and impact of bushfires on life and property with regard to the following risks:

- (a) potential for uncontrolled bushfire events
- (b) high levels and exposure to ember attack;
- (c) impact from burning debris;
- (d) radiant heat; and
- (e) likelihood and direct exposure to flames from a fire front.

DO 2

Activities that increase the number of people living and working in the area or where evacuation would be difficult is situated away from areas of unacceptable bushfire risk.

DO 3

To facilitate access for emergency service vehicles to protect assets and lives from bushfire danger.

Performance Outcomes and Deemed to Satisfy / Designated Performance Outcome Criteria

Land Use

PO 1.1

Development that significantly increases the potential for fire outbreak as a result of the spontaneous combustion of materials, spark generation or through the magnification and reflection of light are not located in areas of unacceptable bushfire risk.

DTS/DPF 1.1

None are applicable.

PO 1.2

Pre-schools, educational establishments, hospitals, retirement and supported accommodation are sited away from:

- (a) areas of unacceptable bushfire risk; and
- (b) locations where staff, children, students, residents and the public cannot be safely evacuated in the event of a bushfire.

DTS/DPF 1.2

None are applicable.

Siting

PO 2.1

Buildings and structures are located away from areas that pose an unacceptable bushfire risk as a result of:

- (a) vegetation cover comprising trees and/or shrubs and/or unmanaged grasslands;
- (b) poor access;
- (c) rugged terrain;
- (d) isolated location (e.g. more than 600m from a public road);
- (e) inability to provide an adequate asset protection zone; and/or

(f) inability to provide a suitable site for an adequate supply of water for firefighting purposes.

DTS/DPF 2.1

None are applicable.

Built Form

PO 3.1

Buildings and structures are designed and configured to reduce the impact of bushfire through using designs that reduce the potential for trapping burning debris against or underneath the building or structure, or between the ground and building floor level in the case of transportable buildings and buildings on stilts.

DTS/DPF 3.1

None are applicable.

PO 3.2

Extensions to existing buildings, outbuildings and other ancillary structures are sited and constructed using materials to minimise the threat of fire spread to residential and tourist accommodation (including boarding houses, hostels, dormitory style accommodation, student accommodation and workers accommodation) in the event of bushfire.

DTS/DPF 3.2

None are applicable.

Habitable Buildings

PO 4.1

To minimise the threat, impact and potential exposure to bushfires on life and property, residential and tourist accommodation (including boarding houses, hostels, dormitory style accommodation, student accommodation and workers accommodation) are sited on the flatter portion of allotments and avoid steep slopes, especially:

- (a) upper slopes;
- (b) narrow ridge crests and the tops of narrow gullies; and
- (c) slopes with a northerly or westerly aspect.

DTS/DPF 4.1

None are applicable.

PO 4.2

Residential and tourist accommodation (including boarding houses, hostels, dormitory style accommodation, student accommodation and workers accommodation):

- (a) are sited away from vegetated areas that pose an unacceptable bushfire risk; and
- (b) minimise the need to clear native vegetation.

DTS/DPF 4.2

Development meets the following requirements:

- (a) an asset protection zone with a minimum width of 100m already exists and can be maintained around the accommodation; and
- (b) the asset protection zone is contained wholly within the allotment of the development.

PO 4.3

Residential and tourist accommodation (including boarding houses, hostels, dormitory style accommodation, student accommodation and workers accommodation) have a dedicated area available that:

- (a) is capable of accommodating a bushfire protection system comprising firefighting equipment and water supply in accordance with Ministerial Building Standard SA 008; and
- (b) includes the provision of an all-weather hardstand area in a location that:
 - i. allows fire-fighting vehicles to safely access the dedicated water supply and exit the site in a forward direction; and
 - ii. is no further than 6 metres from the dedicated water supply outlet(s).

DTS/DPF 4.3

None are applicable.

Land Division

PO 5.1

Land division for residential and tourist accommodation (including boarding houses, hostels, dormitory style accommodation, student accommodation and workers accommodation) will:

- (a) be limited to those areas specifically set aside for these uses; and
- (b) ensure provision of a bushfire buffer zone that isolates residential allotments from areas that pose an unacceptable bushfire risk by containing the allotments within a perimeter road and use of other means such as open parks and sporting areas that achieve adequate separation (Figure 1).

DTS/DPF 5.1

None are applicable.

PO 5.2

Land division designed to:

- (a) minimise fire risk danger to residents, other occupants of buildings and firefighting personnel;
- (b) minimise the potential risk of damage to buildings and other property during a bushfire; and
- (c) ensure each allotment contains a suitable building envelope that is located away from any vegetation that would pose an unacceptable risk in the event of bushfire.

DTS/DPF 5.2

None are applicable.

PO 5.3

Land division designed in accordance with Figure 1 to:

- (a) facilitate the movement of emergency vehicles through, within and out of bushfire risk areas;
- (b) provide a mainly continuous street pattern serving new allotments that eliminates the use of cul-de-sacs or dead end roads. Where cul-de-sacs/dead end roads are proposed an alternative emergency evacuation route is provided;
- (c) facilitate the safe and efficient evacuation of residents, visitors and other personnel during a bushfire event and not rely on fire tracks as means of evacuation; and
- (d) include at least two separate entry/exit points where 10 or more allotments are proposed.

DTS/DPF 5.3

None are applicable.

Vehicle Access –Roads and Driveways

PO 6.1

Roads are designed and constructed to:

- (a) facilitate the safe and effective:
 - i. use, operation and evacuation of fire-fighting and emergency personnel; and
 - ii. evacuation of residents.
- (b) avoid the unnecessary clearance of native vegetation

DTS/DPF 6.1

Roads:

- (a) do not require the clearance of native vegetation;
- (b) are constructed with a formed, all-weather surface;
- (c) have a gradient of not more than 16 degrees (1-in-3.5) at any point along the road;
- (d) have a cross fall of not more than 6 degrees (1-in-9.5) at any point along the road;
- (e) have a minimum formed road width of 6m;
- (f) provide overhead clearance of not less than 4.0m between the road surface and overhanging branches or other obstructions including buildings and/or structures (Figure 2);
- (g) allow fire-fighting services (personnel and vehicles) to travel in a continuous forward movement around road curves by constructing the curves with a minimum external radius of 12.5m (Figure 3);
- (h) incorporating use of cul-de-sac endings or dead end roads to not exceed 200m in length and the end of the road to have either:
 - i. a turning area with a minimum formed surface radius of 12.5m (Figure 4); or
 - ii. a 'T' or 'Y' shaped turning area with a minimum formed surface length of 11m and minimum internal radii of 9.5m (Figure 5); and
- (i) incorporate solid, all-weather crossings that support fire-fighting vehicles with a gross vehicle mass (GVM) of 21 tonnes, over any watercourse.

PO 6.2

Where the furthest point of the building from the nearest public road is greater than 30m, driveways are designed and constructed to:

- (a) facilitate the safe and effective:
 - i. use, operation and evacuation of fire-fighting and emergency personnel; and
 - ii. evacuation of residents; and
- (b) avoid the unnecessary clearance of native vegetation

DTS/DPF 6.2

Driveways:

- (a) do not require the clearance of native vegetation;
- (b) do not exceed 600m in length;
- (c) are constructed with a formed, all-weather surface;
- (d) are connected to a formed, all-weather public road with the transition area between the road and driveway having a gradient of not more than 7 degrees (1-in-8);
- (e) have a gradient of not more than 16 degrees (1-in-3.5) at any point along the driveway;
- (f) have a cross fall of not more than 6 degrees (1-in-9.5) at any point along the driveway;
- (g) have a minimum formed width of 3m (4m where the gradient of the driveway is steeper than 12 degrees (1-in-4.5) plus 0.5 metres clearance either side of the driveway from overhanging branches or other obstructions, including buildings and/or structures (Figure 2);

- (h) incorporate passing bays with a minimum width of 6m and length of 17m every 200m (Figure 6);
- (i) provide overhead clearance of not less than 4.0m between the driveway surface and overhanging branches or other obstructions, including buildings and/or structures (Figure 2);
- (j) allow fire-fighting services (personnel and vehicles) to travel in a continuous forward movement around driveway curves by constructing the curves with a minimum external radius of 12.5m (Figure 3);
- (k) allow fire-fighting vehicles to safely enter and exit an allotment in a forward direction by incorporating at the end of the driveway either:
 - i. a loop road around the building; or
 - ii. a turning area with a minimum radius of 12.5m (Figure 4); or
 - iii. a 'T' or 'Y' shaped turning area with a minimum formed length of 11m and minimum internal radii of 9.5m (Figure 5).
- (l) incorporate solid, all-weather crossings that support fire-fighting vehicles with a gross vehicle mass (GVM) of 21 tonnes, over any watercourse.

Procedural Matters (PM)

Referrals		
Class of Development / Activity	Referral Body	Purpose of Referral
<p>The following types of development (including alterations and additions which increase the floor area of such buildings by 10% or more):</p> <ul style="list-style-type: none"> (a) Land Division creating one or more additional allotments; (b) Dwellings; (c) Ancillary accommodation; (d) Residential flat buildings; (e) Tourist accommodation; (f) Boarding homes; (g) Dormitory style accommodation; (h) Workers' accommodation (i) Student accommodation (j) Pre-schools; (k) Educational establishments; (l) Retirement villages; (m) Supported accommodation; (n) Residential parks; (o) Hospitals. 	<p>South Australian Country Fire Service</p>	<p>To provide expert assessment and direction to the relevant authority on the potential impacts of bushfire on the development.</p>

Figures and Diagrams

Land Division

Figure 1 – Land Division Layout

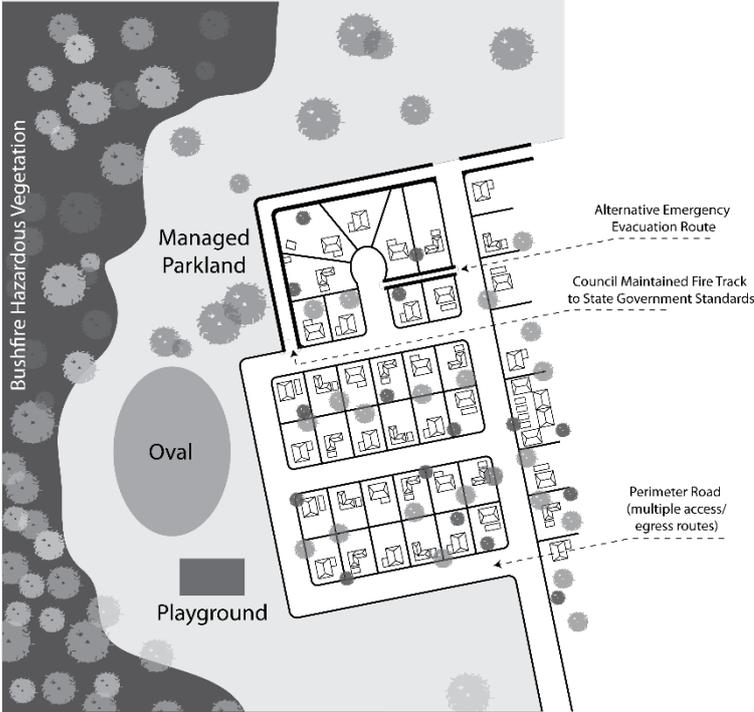

Fire Appliance Clearances

Figure 2 – Overhead and Side Clearances

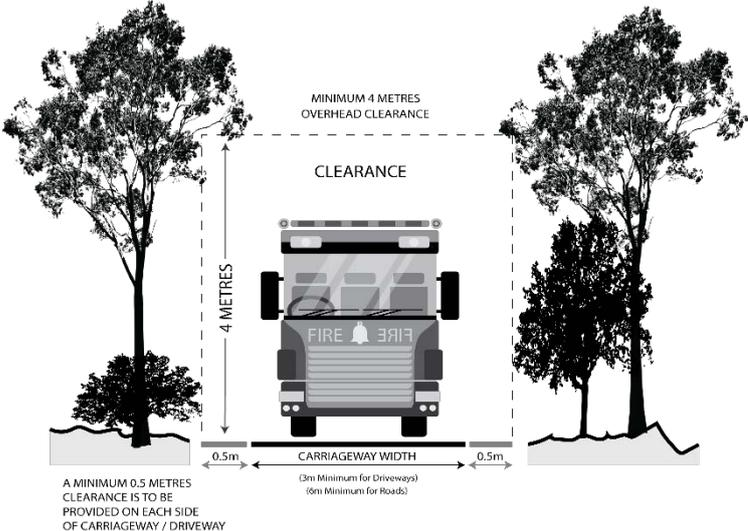

Roads and Driveway Design

Figure 3 - Road and Driveway Curves

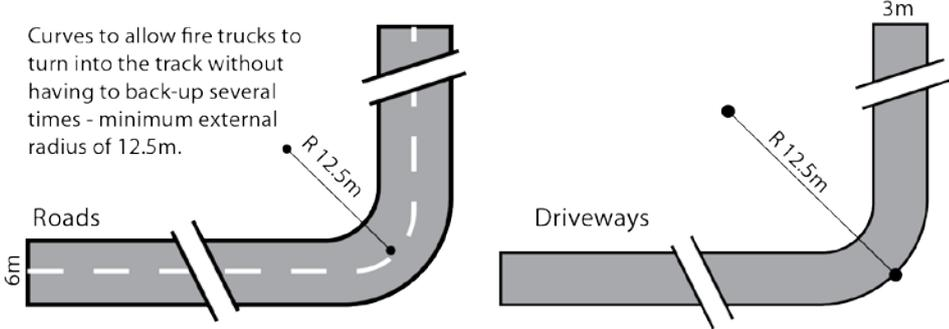

Figure 4 – Full Circle Turning Area

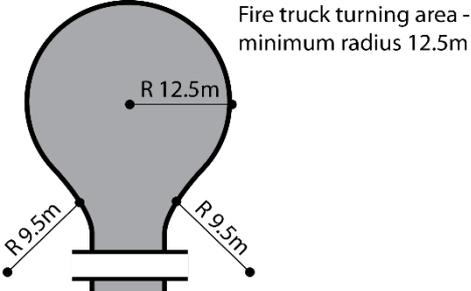

Figure 5 - 'T' or 'Y' Shaped Turning Head

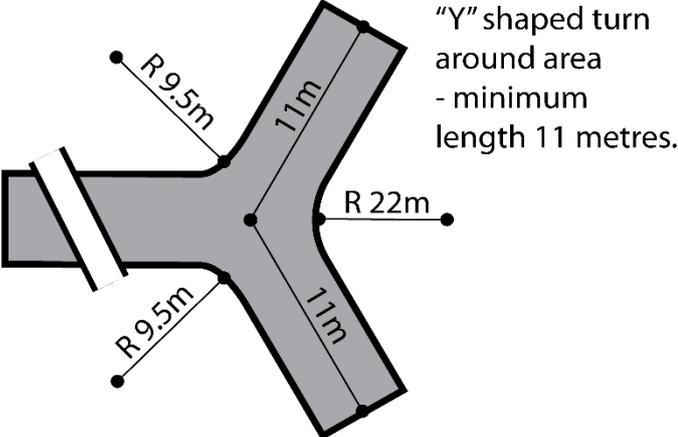
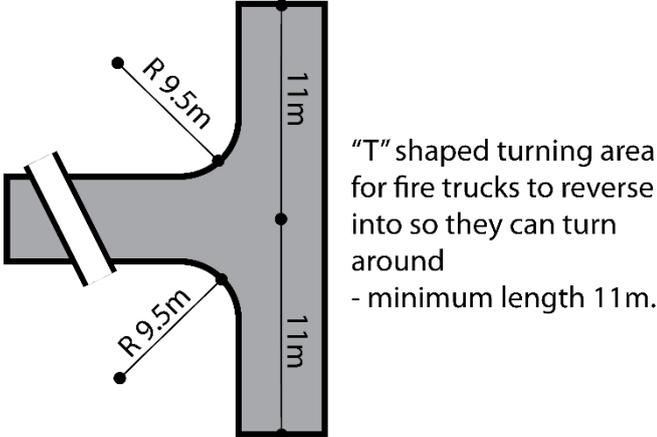
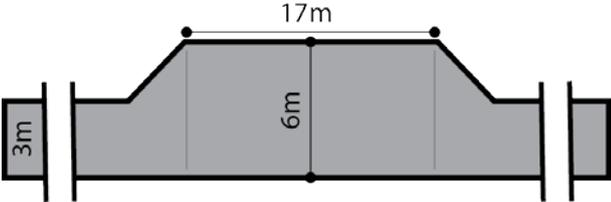

Figure 6 - Driveway Passing Bays

Passing bay for fire trucks - minimum width 6 metres, minimum length 17 metres.



Hazards (Bushfire – Medium Risk) Overlay

Assessment Provisions (AP)

Desired Outcomes (DO)

DO 1

Development responds to the medium level of bushfire risk and potential for ember attack and radiant heat by siting and designing buildings in a manner that mitigates the threat and impact of bushfires on life and property.

DO 2

To facilitate access for emergency service vehicles to protect assets and lives from bushfire danger.

Performance Outcomes and Deemed to Satisfy / Designated Performance Outcome Criteria

Siting

PO 1.1

Buildings and structures are located away from areas that pose an unacceptable bushfire risk as a result of:

- (a) vegetation cover comprising trees and/or shrubs and/or unmanaged grasslands;
- (b) poor access;
- (c) rugged terrain;
- (d) isolated location (e.g. more than 600m from a public road);
- (e) inability to provide an adequate asset protection zone; and/or
- (f) inability to provide a suitable site for an adequate supply of water for firefighting purposes.

DTS/DPF 1.1

None are applicable.

Built Form

PO 2.1

Buildings and structures are designed and configured to reduce the impact of bushfire through using designs that reduce the potential for trapping burning debris against or underneath the building or structure, or between the ground and building floor level in the case of transportable buildings and buildings on stilts.

DTS/DPF 2.1

None are applicable.

PO 2.2

Extensions to existing buildings, outbuildings and other ancillary structures are sited and constructed using materials to minimise the threat of fire spread to residential and tourist accommodation (including boarding houses, hostels, dormitory style accommodation, student accommodation and workers accommodation) in the event of bushfire.

DTS/DPF 2.2

None are applicable.

Habitable Buildings

PO 3.1

To minimise the threat, impact and potential exposure to bushfires on life and property, residential and tourist accommodation (including boarding houses, hostels, dormitory style accommodation, student

accommodation and workers accommodation) are sited on the flatter portion of allotments and avoid steep slopes, especially:

- (a) upper slopes;
- (b) narrow ridge crests and the tops of narrow gullies; and
- (c) slopes with a northerly or westerly aspect.

DTS/DPF 3.1

None are applicable.

PO 3.2

Residential and tourist accommodation (including boarding houses, hostels, dormitory style accommodation, student accommodation and workers accommodation):

- (a) are sited away from vegetated areas that pose an unacceptable bushfire risk; and
- (b) minimise the need to clear native vegetation.

DTS/DPF 3.2

Development meets the following requirements:

- (a) an asset protection zone with a minimum width of 50m already exists and can continue to be maintained around the accommodation; and
- (b) the asset protection zone is contained wholly within the allotment of the development.

PO 3.3

Residential and tourist accommodation (including boarding houses, hostels, dormitory style accommodation, student accommodation and workers accommodation) have a dedicated area available that is capable of accommodating a bushfire protection system comprising firefighting equipment and water supply in accordance with Ministerial Building Standard SA 008.

DTS/DPF 3.3

None are applicable.

Land Division

PO 4.1

Land division is designed to:

- (a) minimise fire risk danger to residents, other occupants of buildings and firefighting personnel;
- (b) minimise the potential risk of damage to buildings and other property during a bushfire; and
- (c) ensure each allotment contains a suitable building envelope that is located away from any vegetation that would pose an unacceptable risk in the event of bushfire.

DTS/DPF 4.1

None are applicable.

PO 4.2

Land division designed in accordance with Figure 1 to:

- (a) facilitate the movement of emergency vehicles through, within and out of bushfire risk areas;
- (b) provide a mainly continuous street pattern serving new allotments that eliminates the use of cul-de-sacs or dead end roads. Where cul-de-sacs/dead end roads are proposed an alternative emergency evacuation route is provided;

- (c) facilitate the safe and efficient evacuation of residents, visitors and other personnel during a bushfire event and not rely on fire tracks as means of evacuation; and
- (d) include at least two separate entry/exit points where 10 or more allotments are proposed.

DTS/DPF 4.2

None are applicable.

PO 4.3

Land division will ensure provision of a bushfire buffer zone that isolates residential allotments from areas that pose an unacceptable bushfire risk by containing the allotments within a perimeter road and other means such as open parks and sporting areas that achieve adequate separation (Figure 1).

DTS/DPF 4.3

None are applicable.

Vehicle Access –Roads and Driveways

PO 5.1

Roads are designed and constructed to:

- (a) facilitate the safe and effective:
 - i. use, operation and evacuation of fire-fighting and emergency personnel; and
 - ii. evacuation of residents; and
- (b) avoid the unnecessary clearance of native vegetation.

DTS/DPF 5.1

Roads:

- (a) do not require the clearance of native vegetation;
- (b) are constructed with a formed, all-weather surface;
- (c) have a gradient of not more than 16 degrees (1-in-3.5) at any point along the road;
- (d) have a cross fall of not more than 6 degrees (1-in-9.5) at any point along the road;
- (e) have a minimum formed road width of 6m;
- (f) provide overhead clearance of not less than 4.0m between the road surface and overhanging branches or other obstructions including buildings and/or structures (Figure 2);
- (g) allow fire-fighting services (personnel and vehicles) to travel in a continuous forward movement around road curves by constructing the curves with a minimum external radius of 12.5m (Figure 3);
- (h) incorporating use of cul-de-sac endings or dead end roads to not exceed 200m in length and the end of the road to have either:
 - i. a turning area with a minimum formed surface radius of 12.5m (Figure 4); or
 - ii. a 'T' or 'Y' shaped turning area with a minimum formed surface length of 11m and minimum internal radii of 9.5m (Figure 5); and
- (i) incorporate solid, all-weather crossings that support fire-fighting vehicles with a gross vehicle mass (GVM) of 21 tonnes, over any watercourse.

PO 5.2

Where the furthest point of the building from the nearest public road is greater than 30m, driveways are designed and constructed to:

- (a) facilitate the safe and effective:
 - i. use, operation and evacuation of fire-fighting and emergency personnel; and
 - ii. evacuation of residents; and

- (b) avoid the unnecessary clearance of native vegetation.

DTS/DPF 5.2

Driveways:

- (a) do not require the clearance of native vegetation;
- (b) do not exceed 600m in length;
- (c) are constructed with a formed, all-weather surface;
- (d) are connected to a formed, all-weather public road with the transition area between the road and driveway having a gradient of not more than 7 degrees (1-in-8);
- (e) have a gradient of not more than 16 degrees (1-in-3.5) at any point along the driveway;
- (f) have a cross fall of not more than 6 degrees (1-in-9.5) at any point along the driveway;
- (g) have a minimum formed width of 3m (4m where the gradient of the driveway is steeper than 12 degrees (1-in-4.5) plus 0.5 metres clearance either side of the driveway from overhanging branches or other obstructions, including buildings and/or structures (Figure 2);
- (h) incorporate passing bays with a minimum width of 6m and length of 17m every 200m (Figure 6);
- (i) provide overhead clearance of not less than 4.0m between the driveway surface and overhanging branches or other obstructions, including buildings and/or structures (Figure 2);
- (j) allow fire-fighting services (personnel and vehicles) to travel in a continuous forward movement around driveway curves by constructing the curves with a minimum external radius of 12.5m (Figure 3);
- (k) allow fire-fighting vehicles to safely enter and exit an allotment in a forward direction by incorporating at the end of the driveway either:
 - i. a loop road around the building; or
 - ii. a turning area with a minimum radius of 12.5m (Figure 4); or
 - iii. a 'T' or 'Y' shaped turning area with a minimum formed length of 11m and minimum internal radii of 9.5m (Figure 5).
- (l) incorporate solid, all-weather crossings that support fire-fighting vehicles with a gross vehicle mass (GVM) of 21 tonnes, over any watercourse.

Procedural Matters (PM) Procedural Matters (PM)

Referrals		
Class of Development / Activity	Referral Body	Purpose of Referral
None	None	None

Figures and Diagrams

Land Division

Figure 1 – Land Division Layout

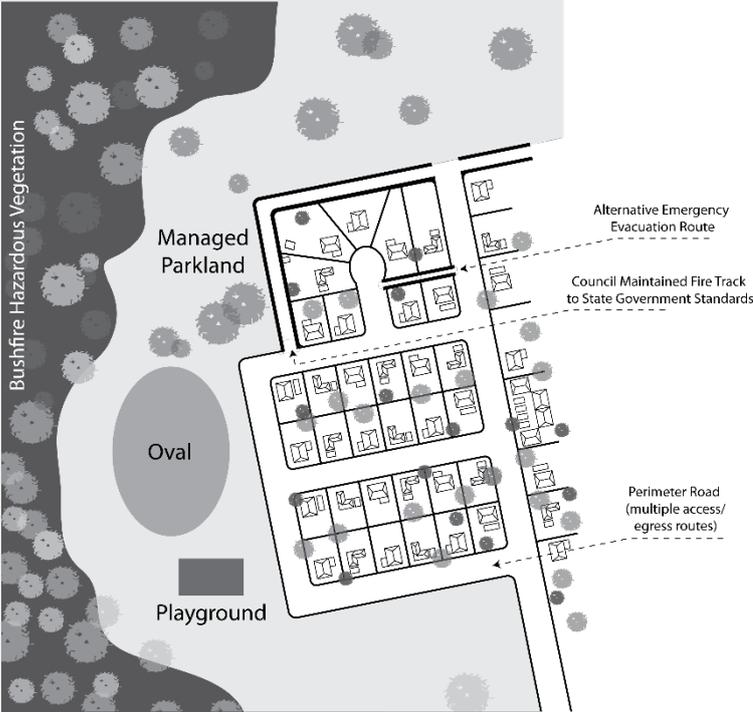

Fire Engine and Appliance Clearances

Figure 2 – Overhead and Side Clearances

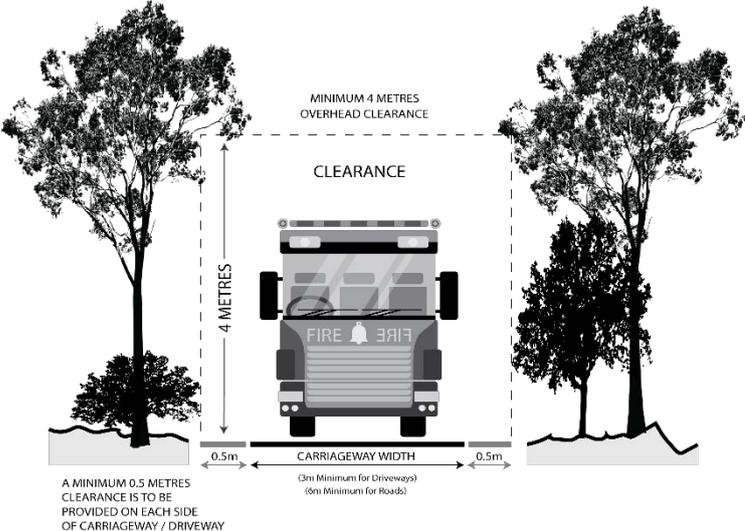

Roads and Driveway Design

Figure 3 - Road and Driveway Curves

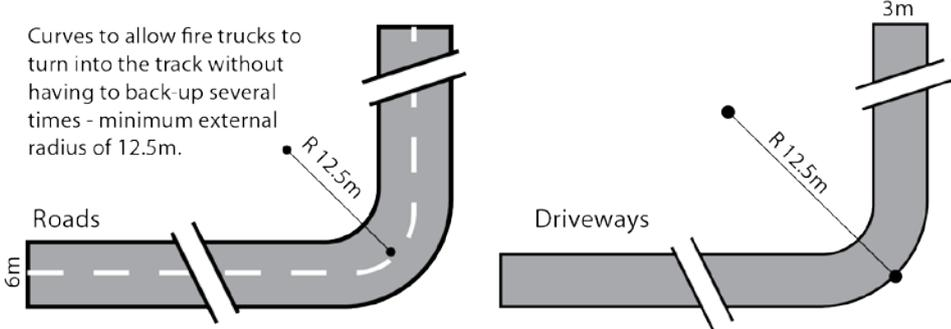

Figure 4 – Full Circle Turning Area

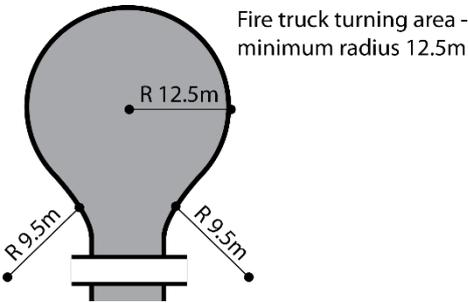

Figure 5 - 'T' or 'Y' Shaped Turning Head

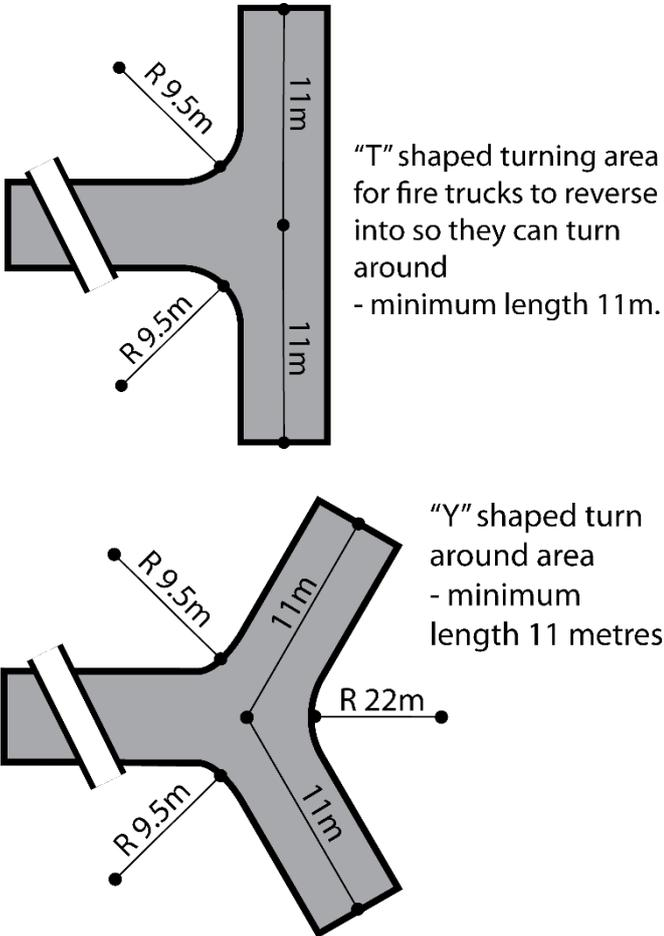
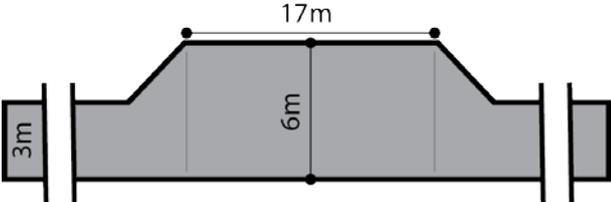

Figure 6 - Driveway Passing Bays

Passing bay for fire trucks - minimum width 6 metres, minimum length 17 metres.



Hazards (Bushfire – Urban Interface) Overlay

Assessment Provisions (AP)

Desired Outcomes (DO)

DO 1

Urban neighbourhoods that adjoin areas of General, Medium and High Bushfire Risk allow access through to bushfire risk areas, are designed to protect life and property from the threat of bushfire and the dangers posed by ember attack and facilitate evacuation to areas safe from bushfire danger.

Performance Outcomes and Deemed to Satisfy / Designated Performance Outcome Criteria

Land Division

PO 1.1

Land division within the Urban Interface is designed to make provision for:

- (a) emergency vehicle access through to the bushfire risk area;
- (b) a mainly continuous street pattern serving new allotments that eliminates the use of cul-de-sacs or dead end roads. Where cul-de-sacs/dead end roads are proposed an alternative emergency evacuation route is provided;
- (c) the safe and efficient evacuation of residents, visitors and other personnel during a bushfire event and not rely on fire tracks as means of evacuation;
- (d) include at least two separate entry/exit points where 10 or more allotments are proposed; and
- (e) a bushfire buffer zone isolating residential allotments from areas of unacceptable bushfire risk by containing the allotments within a perimeter road and through other means such as open parks and sporting areas that achieve adequate separation (Figure 1).

DTS/DPF 1.1

None are applicable

Procedural Matters (PM)

Referrals		
Class of Development / Activity	Referral Body	Purpose of Referral
None	None	None

Land Division

Figure 1 – Land Division Layouts

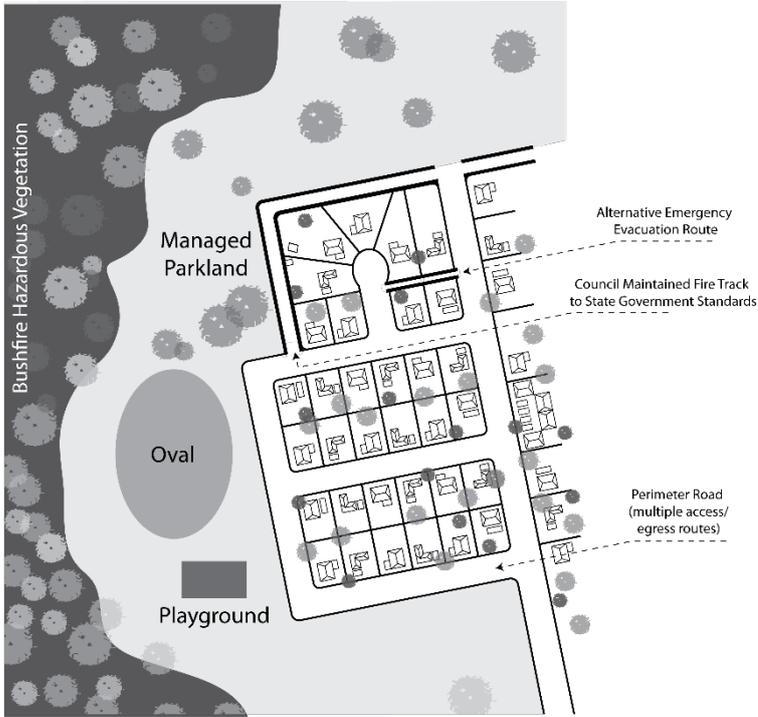

Hazards (Flooding) Overlay

Assessment Provisions (AP)

Desired Outcome (DO)

DO 1

Minimise impacts on people, property, infrastructure and the environment from exposure to flood hazard risk through limitation of development intensification.

Performance Outcomes and Deemed to Satisfy / Designated Performance Outcome Criteria

Land Division

PO 1.1

Land division limited to areas where the consequences to buildings and safety are low and can be readily managed or overcome.

DTS/DPF 1.1

Land division resulting in the creation of new allotments occurs outside of areas where flood depth would exceed 0.3m above natural ground level and flood velocity would exceed 0.3m per second during a 1% AEP flood event.

PO 1.2

Allotments can be connected to a public stormwater system capable of catering for a 1% AEP flood event.

DTS/DPF 1.2

None are applicable

PO 1.3

Land is not divided unless a layout is achieved whereby roads, parking areas and development sites for each allotment are at least 0.3m above the 1% AEP flood event level, unless the land is, or can be provided with flood protection measures that are appropriate and acceptable for the intended future land use.

DTS/DPF 1.3

None are applicable

Land Use

PO 2.1

Buildings housing vulnerable people, community services facilities and emergency services are sited away from areas of unacceptable flood risk.

DTS/DPF 2.1

Pre-schools, educational establishments, retirement and supported accommodation, emergency services facilities, hospitals and prisons located outside of the 1% AEP flood area.

Flood Resilience

PO 3.1

Development avoids necessitating flood protection works through measures such as setbacks to protect development from the impacts of flooding.

DTS/DPF 3.1

None are applicable

PO 3.2

Development does not cause unacceptable impacts on any adjoining property by diversion of flood waters, increase in flood velocity or flood level, or cause an unacceptable loss of flood storage.

DTS/DPF 3.2

Development is limited to:

- (a) buildings, structures or earthworks required as part of flood protection works associated with a regional flood mitigation scheme; or
- (b) recreation area.

PO 3.3

Buildings sited, designed and constructed to prevent the entry of floodwaters in a 1% AEP flood event where the entry of flood waters is likely to result in undue damage to or compromise ongoing activities within buildings.

DTS/DPF 3.3

None are applicable

PO 3.4

Development, including outbuildings and fences, does not impede floodwaters.

DTS/DPF 3.4

None are applicable

Environmental Protection

PO 4.1

Buildings used either partly or wholly to contain or store hazardous materials designed to prevent spills or leaks leaving the confines of the building during a 1% AEP flood event to avoid potential environmental harm.

DTS/DPF 4.1

Development involving storage or disposal of hazardous materials is wholly located outside of the 1% AEP flood level.

PO 4.2

Development does not create or aggravate the potential for erosion or siltation or lead to the destruction of vegetation during a flood.

DTS/DPF 4.2

None are applicable

Site Earthworks

PO 5.1

The depth and extent of filling required to raise the finished floor level of a building does not cause unacceptable impact on any adjoining property by diversion of flood waters, an increase in flood velocity or flood level, or cause an unacceptable loss of flood storage.

DTS/DPF 5.1

None are applicable

PO 5.2

Driveways, access tracks and parking areas are designed and constructed to minimise excavation and filling.

DTS/DPF 5.2

Filling for ancillary purposes:

- (a) does not exceed 100mm above existing ground level; and
- (b) is no more than 5m wide.

Access

PO 6.1

Development does not occur on land:

- (a) from which evacuation to areas not vulnerable to flood risk is not possible during a 1% AEP flood event; or
- (b) which cannot be accessed by emergency services vehicles or essential utility service vehicles during a 1% AEP flood event.

DTS/DPF 6.1

None are applicable

PO 6.2

Access driveways and tracks to significant development (i.e. dwellings, places of work, etc.) consist of a safe, all-weather trafficable surface that is accessible during a 1% AEP flood event.

DTS/DPF 6.2

None are applicable

Procedural Matters (PM)

Referrals		
Class of Development / Activity	Referral Body	Purpose of Referral
None	None	None

Historic Shipwrecks Overlay

Assessment Provisions (AP)

Desired Outcome (DO)

DO 1

Historic shipwrecks and historic relics protected from encroaching development.

Performance Outcomes and Deemed to Satisfy / Designated Performance Outcome Criteria

General

PO 1.1

Development located and designed to avoid potential impacts on historic shipwrecks and historic relics.

DTS/DPF 1.1

Development involving impact to the surface or subsoil of land or sea/river floor is not located:

- a. seaward of the mean high water mark; or

b. within 15m landward of the existing banks of the River Murray.

Procedural Matters (PM)

Referrals		
Class of Development / Activity	Referral Body	Purpose of Referral
Development that may involve impact to the surface or subsoil of land or the floor of a sea, lake or river.	The Minister responsible for administering the <i>Historic Shipwrecks Act 1981</i>	To provide expert assessment and direction to the relevant authority on the potential impacts of development on, or in proximity to, historic shipwrecks or relics protected under the relevant Act.

Key Outback and Rural Route Overlay

Assessment Provisions (AP)

Desired Outcomes (DO)

DO 1

Safe and efficient movement of vehicle and freight traffic on key outback and rural routes.

DO 2

Provision of safe and efficient vehicular access to and from key outback and rural routes.

Performance Outcomes and Deemed to Satisfy / Designated Performance Outcome Criteria

Access – Safe Entry and Exit (Traffic Flow)

PO 1.1

Access points designed to allow safe entry and exit to and from a site to meet the needs of development, to ensure traffic flow interference associated with access movements is minimised.

DTS/DPF 1.1

An access point is located outside of a Township Zone and is designed to ensure:

- (a) the following for the largest vehicle expected to access the site:
 - i. entry and exit movements are left turn only;
 - ii. access to and from the site is in a forward direction, with on-site manoeuvring available through circulation around the site or no more than a 3-point turn;
 - iii. vehicles cross the property boundary at an angle between 70 and 90 degrees; and
 - iv. iv) access to and from the site using the kerbside lane of the road; and
- (b) where the access point services or is intended to service:
 - i. a single dwelling, the access point has a width of no more than 4m (measured at the site boundary); or
 - ii. development other than a single dwelling, the access point has:
 - A. a width of at least 6.0 m (measured at the site boundary) where vehicles 12.5m or less in length are expected to access the site; or
 - B. a width of at least 8.0m (measured at the site boundary) where vehicles over 12.5m in length are expected to access the site; and
- (c) the access point is located 10m or more from any roadside infrastructure or trees.

Access – On-Site Queuing

PO 2.1

Sufficient accessible on-site queuing adjacent to access points is provided to meet the needs of development so that all vehicle queues are contained fully within the boundaries of the development site, to minimise interruption on the functional performance of the road and safe vehicle movement.

DTS/DPF 2.1

An access point:

- a. will be used by vehicles no greater than 12.5m in length and is not connected to internal intersections, car parking spaces, car park isles or any internal obstructions within 20m of the access point; or
- b. serves a single dwelling and there are no internal driveway intersections car parking spaces or gates within 6.0m of the access point

Access - Existing Access Points

PO 3.1

Existing access points designed to accommodate the type and volume of traffic likely to be generated by the development.

DTS/DPF 3.1

An existing access point:

- a. will not service and is not intended to service more than 6 dwellings; or
- b. will service development that will not result in:
 - i. an increase in traffic using an existing access point that is greater than 10% of the traffic volumes using the existing access prior to the development or 60 vehicles per day (whichever is the lesser); or
 - ii. a larger class of vehicle expected to access the site using the existing access.

Access – Location (Spacing)

PO 4.1

New access points are widely spaced apart from any existing access point or public road junction to not impede traffic flow and ensure safe and efficient road operating conditions.

DTS/DPF 4.1

Where access from an alternative road at least 25m from the Key Outback and Rural Route is not available, a new access point is:

- a. not located on a section affected by double barrier lines between either edge of the access point; and
- b. at least the following distance from a public road junction or railway, or terminating / merging lane or another access point:
 - i. 110 km/h road – 325m
 - ii. 100 km/h road – 280m
 - iii. 90 km/h road – 240m
 - iv. 80 km/h road – 200m
 - v. 70 km/h road – 165m
 - vi. 60 km/h road – 135m
 - vii. 50km/h or less road – 105m

Access – Location (Sight Lines)

PO 5.1

Access points located and designed to ensure appropriate sight distances are provided so that drivers:

- (a) on the road approaching the access point are able to recognise the presence of the access point and/or see a vehicle turning into or out of the access point in time to slow down or stop in a safe and controlled manner; and
- (b) exiting the access point onto the road can see approaching vehicles to avoid potential conflict.

DTS/DPF 5.1

Drivers approaching or exiting a new access point have an unobstructed line of sight to or from the new access point in accordance with the following distances:

- i. 110 km/h road – 325m
- ii. 100 km/h road – 280m
- iii. 90 km/h road – 240m

- iv. 80 km/h road – 200m
- v. 70 km/h road – 165m
- vi. 60 km/h road – 135m; and
- vii. 50km/h or less road – 105m.

Access – Mud and Debris

PO 6.1

Access points constructed to minimise mud or other debris being carried or transferred onto roads, to ensure safe road operating conditions.

DTS/DPF 6.1

The access way is spray sealed (except where the access point is for a single dwelling, or where the Key Outback or Rural Route is unsealed) from the road to a point not less than 10m into the site.

Access – Stormwater

PO 7.1

Access points designed to minimise negative impact on roadside drainage of water.

DTS/DPF 7.1

Development does not:

- (a) decrease the capacity of an existing drainage point; or
- (b) restrict or prevent the flow of stormwater to an existing drainage point and system.

Building on Road Reserve

PO 8.1

Buildings or structures that encroach onto, above or below road reserves designed and sited to minimise impact on safe movements by all road users.

DTS/DPF 8.1

No encroachment of buildings or structures onto, above or below the road reserve.

Public Road Junctions

PO 9.1

New junctions with public roads (including the opening of unmade public road junctions) and modifications to existing road junctions located and designed to ensure safe and efficient road operating conditions.

DTS/DPF 9.1

Development does not involve creation of a new junction with a public road, opening of an unmade public road junction or modification to an existing public road junction.

Corner Cut-Offs

PO 10.1

Development located and designed to ensure drivers can safely turn into and out of public road junctions.

DTS/DPF 10.1

None are applicable.

Procedural Matters (PM)

Referrals		
Class of Development / Activity	Referral Body	Purpose of Referral
<p>Except where all of the relevant deemed-to-satisfy criteria are met, development (including the division of land) that:</p> <ul style="list-style-type: none">(a) creates a new access or junction; or(b) proposes either of the following (except where deemed to be minor in the opinion of the relevant authority):<ul style="list-style-type: none">i. alters an existing access or public road junction; orii. may change the nature of vehicular movements or increase the number or frequency of movements through an existing access; <p>on a Key Outback or Rural Routes road or within 25m of an intersection with such a road.</p>	Commissioner of Highways	To provide expert technical assessment and direction to the Relevant Authority on the safe and efficient operation and management of all roads relevant to the Commissioner of Highways as described in the Planning and Design Code.

Key Railway Crossings Overlay

Assessment Provisions (AP)

Desired Outcome (DO)

DO 1

Safe, efficient and uninterrupted operation of key railway crossings.

Performance Outcomes and Deemed to Satisfy / Designated Performance Outcome Criteria

Access Design and Function

PO 1.1

Site access does not interfere or impact on the safe operation of a railway crossing.

DTS/DPF 1.1

Development does not involve a new or modified access or an increase in traffic through an existing access that is located within the following distance from a railway crossing:

- i. 110 km/h road – 190m
- ii. 100 km/h road – 165m
- iii. 90 km/h road – 140m
- iv. 80 km/h road – 110m
- v. 70 km/h road – 90m
- vi. 60 km/h road – 70m
- vii. 50km/h or less road – 50m

Procedural Matters

Referrals		
Class of Development / Activity	Referral Body	Purpose of Referral
None	None	None

Limited Land Division Overlay

Assessment Provisions (AP)

Desired Outcomes (DO)

DO 1

Limitation of land fragmentation to pursue various outcomes.

Performance Outcomes and Deemed to Satisfy / Designated Performance Outcome Criteria

General

PO 1.1

Land division does not result in the creation of an additional allotment.

DTS/DPF 1.1

No additional allotments are created.

Procedural Matters (PM)

Referrals		
Class of Development / Activity	Referral Body	Purpose of Referral
None	None	N/A

Major Urban Transport Routes Overlay

Assessment Provisions (AP)

Desired Outcomes (DO)

DO 1

Safe and efficient operation of major urban transport routes for all road users.

DO 2

Provision of safe and efficient access to and from major urban transport routes.

Performance Outcomes and Deemed to Satisfy / Designated Performance Outcome Criteria

Access – Safe Entry and Exit (Traffic Flow)

PO 1.1

Access points designed to allow safe entry and exit to and from a site to meet the needs of development, to ensure traffic flow interference associated with access movements is minimised.

DTS/DPF 1.1

An access point is designed to ensure:

- a. the following for the largest vehicle expected to access the site:
 - (i) entry and exit movements are left turn only;
 - (ii) access to and from the site is in a forward direction, with on-site manoeuvring available through circulation around the site of no more than a 3-point turn;
 - (iii) vehicles cross the property boundary at an angle between 70 degrees and 90 degrees; and
- b. access to and from the site fully within the kerbside lane of the road; and where the access point services, or is intended to service:
 - (i) a single dwelling, the access point has a width of between 3m and 4m (measured at the site boundary); or
 - (ii) between 2 and 6 dwellings, the access point has a width of between 6m and 7m (measured at the site boundary); or
 - (iii) over 6 dwellings or any other non-residential land uses, then:
 - A. where vehicles 6.4m or less are expected to access the site, the access point has a width of between 7m and 10m (measured at the site boundary); or
 - B. where vehicles up to 8.8m in length are expected to access the site, the access point has a width of between 12m and 16m (measured at the site boundary); and
- c. the access point is located 1m or more from any roadside infrastructure or trees.

Access – On-Site Queuing

PO 2.1

Sufficient accessible on-site queuing adjacent to access points is provided to meet the needs of development so that all vehicle queues are contained fully within the boundaries of the development site, to minimise interruption on the functional performance of the road and safe vehicle movement.

DTS/DPF 2.1

An access point:

- (a) will not service, or is not intended to service, more than 6 dwellings and there are no internal driveways, intersections, car parking spaces or gates within 6.0m of the access point; or
- (b) will service development that will generate less than 60 vehicle movements per day; and
 - i. where vehicles no greater than 6.4m in length are expected to access the site, there are no internal driveways, intersections, car parking spaces, car park isles or any other internal obstructions within 10.5m of the access point; or
 - ii. where vehicles no greater than 8.8m in length are expected to access the site, there are no internal driveways, intersections, car parking spaces, car park isles or any other internal obstructions within 14.5m of the access point; or
 - iii. where vehicles over 8.8m in length are expected to access the site, no Deemed-to-Satisfy Criteria applies.

Access – Existing Access Points

PO 3.1

Existing access points designed to accommodate the type and volume of traffic likely to be generated by the development.

DTS/DPF 3.1

An existing access point:

- (a) will not service and is not intended to service more than 6 dwellings; or

- (b) will service development that will not result in:
 - i. an increase in traffic using an existing access point that is greater than 10% of the traffic volumes using the existing access prior to the development or 60 vehicles per day (whichever is the lesser); or
 - ii. a larger class of vehicle expected to access the site using the existing access.

Access – Location (Spacing)

PO 4.1

New access points are widely spaced apart from any existing access point or public road junction to not impede traffic flow and ensure safe and efficient operating conditions are maintained on the road.

DTS/DPF 4.1

Where access from an alternative local road at least 25m from the Major Urban Route is not available, and the access is not located on a Controlled Access Road, a new access point is:

- (a) not located on a section affected by double barrier lines between either edge of the access point; and
- (b) at least the following distance from a public road junction, or terminating / merging lane on a public road:
 - A. 110 km/h road – 325m
 - B. 100 km/h road – 280m
 - C. 90 km/h road – 240m
 - D. 80 km/h road – 200m
 - E. 70 km/h road – 165m
 - F. 60 km/h road – 135m
 - G. 50km/h or less road – 105m; and
- (c) at least the following distance from another private (non-public road) access point:
 - A. 110 km/h road – 190m
 - B. 100 km/h road – 165m
 - C. 90 km/h road – 140m
 - D. 80 km/h road – 110m
 - E. 70 km/h road – 90m
 - F. 60 km/h road – 70m
 - G. 50km/h or less road – 50m

Access – Location (Sight Lines)

PO 5.1

Access points located and designed to ensure appropriate sight distances are provided so that drivers:

- (a) on the road approaching the access point are able to recognise the presence of the access point and/or see a vehicle turning into or out of the access point in time to slow down or stop in a safe and controlled manner; and
- (b) exiting the access point onto the road can see approaching vehicles to avoid potential conflict.

DTS/DPF 5.1

Drivers approaching or exiting a new access point have an unobstructed line of sight to or from the new access point in accordance with the following distances:

- (a) 110 km/h road – 325m
- (b) 100 km/h road – 280m
- (c) 90 km/h road – 240m
- (d) 80 km/h road – 200m

- (e) 70 km/h road – 165m
- (f) 60 km/h road – 135m; and
- (g) 50km/h or less road – 105m.

Access – Mud and Debris

PO 6.1

Access points constructed to minimise mud or other debris being carried or transferred onto the road, to ensure safe road operating conditions.

DTS/DPF 6.1

None are applicable.

Access – Stormwater

PO 7.1

Access points designed to minimise negative impact on roadside drainage of water.

DTS/DPF 7.1

Development does not:

- (a) decrease the capacity of an existing drainage point; or
- (b) restrict or prevent the flow of stormwater to an existing drainage point and system.

Building on Road Reserve

PO 8.1

Buildings or structures that encroach onto, above or below road reserves designed and sited to minimise impact on safe movements by all road users.

DTS/DPF 8.1

No encroachment of buildings or structures onto, above or below the road reserve.

Public Road Junctions

PO 9.1

New junctions with public roads (including the opening of unmade public road junctions) or modifications to existing road junctions located and designed to ensure safe and efficient road operating conditions.

DTS/DPF 9.1

Development does not involve creation of a new junction with a public road, opening of an unmade public road junction or modification to an existing public road junction.

Corner Cut-Offs

PO 10.1

Development located and designed to ensure drivers can safely turn into and out of public road junctions.

DTS/DPF 10.1

Development does not involve building work, or building work is located wholly outside the land shown as “Site Area” in the following diagram:

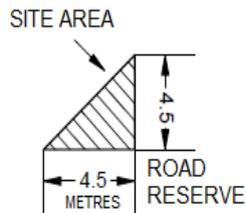

Procedural Matters (PM)

Referrals		
Class of Development / Activity	Referral Body	Purpose of Referral
<p>Except where all of the relevant deemed-to-satisfy criteria are met, development (including the division of land) that:</p> <ol style="list-style-type: none"> creates a new access or junction; or proposes either of the following (except where deemed to be minor in the opinion of the relevant authority): <ol style="list-style-type: none"> alters an existing access or public road junction; or may change the nature of vehicular movements or increase the number or frequency of movements through an existing access; <p>on a Major Urban Traffic Route road or within 25m of an intersection with such a road.</p>	Commissioner of Highways	To provide expert technical assessment and direction to the Relevant Authority on the safe and efficient operation and management of all roads relevant to the Commissioner of Highways as described in the Planning and Design Code.

Marine Parks (Managed Use) Overlay

Assessment Provisions (AP)

Desired Outcomes (DO)

DO 1

Protection of marine habitats and biodiversity through limiting development to coastal infrastructure (jetties, marinas, pontoons), aquaculture, tourism, recreation and renewable energy facilities.

Performance Outcomes and Deemed to Satisfy / Designated Performance Outcome Criteria

Land Use

PO 1.1

Development does not unduly harm marine habitats, biodiversity or the functioning of ecosystems.

DTS/DPF 1.1

None are applicable.

Procedural Matters (PM)

Referrals		
Class of Development / Activity	Referral Body	Purpose of Referral
None	None	None

Marine Parks (Restricted Use) Overlay

Assessment Provisions (AP)

Desired Outcomes (DO)

DO 1

Conservation of high value marine habitats and biological diversity.

Performance Outcomes and Deemed to Satisfy / Designated Performance Outcome Criteria

Land Use

PO 1.1

Development limited to that required to support the ongoing operation of ports and harbours.

DTS/DPF 1.1

None are applicable.

Procedural Matters (PM)

Referrals		
Class of Development / Activity	Referral Body	Purpose of Referral
None	None	None

Native Vegetation Overlay

Assessment Provisions (AP)

Desired Outcome (DO)

DO 1

Protect, retain and restore areas of native vegetation.

Performance Outcome (PO) • Deemed to Satisfy Criteria (DTS)
(required for development to be classified as Deemed-to-Satisfy)

• Designated Performance Feature (DPF)

(used for development to be assessed on its merits against the applicable policies of the Planning and Design Code)

Environmental Protection

PO 1.1

Development avoids, or where it cannot be practically avoided, minimises the clearance of native vegetation taking into account the siting of buildings, access points, bushfire protection measures and building maintenance.

DTS / DPF 1.1

An application is accompanied by:

- (a) a declaration stating that the proposal will not, or would not, involve clearance of native vegetation under the Native Vegetation Act 1991, including any clearance that may occur:
- (i) in connection with a relevant access point and / or driveway;
 - (ii) within 10m of a building (other than a residential building or tourist accommodation);
 - (iii) within 20m of a dwelling or addition to an existing dwelling for fire prevention and control; and/or
 - (iv) within 50m of residential or tourist accommodation in connection with a requirement under a relevant overlay to establish an asset protection zone in a bushfire prone area; or

(b) a report prepared in accordance with Regulation 18(2)(a) of the Native Vegetation Regulations 2017 that establishes that the clearance is categorised as 'low level clearance'.

PO 1.2

Native vegetation clearance in association with development avoids the following:

- (a) significant wildlife habitat and movement corridors;
- (b) of rare, vulnerable or endangered plants species;
- (c) that is significant because it is located in an area which has been extensively cleared; or
- (d) that is growing in, or in association with, a wetland environment.

None are applicable.

PO 1.3

Intensive animal husbandry and agricultural activities are sited, setback and designed to minimise impacts on native vegetation, including impacts on native vegetation in State Significant Native Vegetation Areas, from:

- (a) the spread of pest plants and phytophthora;
- (b) the spread of non-indigenous plants species;
- (c) excessive nutrient loading of the soil or arising from surface water runoff;
- (d) soil compaction; or
- (e) chemical spray drift. DTS / DPF 1.3

All classes of development, other than the following located within 500 metres of a boundary of an area identified in the State Significant Native Vegetation Areas Overlay:

- (a) horticulture;
- (b) intensive animal husbandry;

- (c) dairy;
- (d) commercial forestry; or
- (e) aquaculture.

Land division

PO 2.1

Land division that does not result in the fragmentation of land containing native vegetation, or necessitate the clearance of native vegetation, unless such clearance is considered minor, taking into account the location of allotment boundaries, accessways, fire breaks, boundary fencing, and potential building siting or the like.

DTS / DPF 2.1

Land division where:

(a) an application is accompanied by:

(i) a declaration stating that none of the allotments in the proposed plan of division contain native vegetation under the Native Vegetation Act 1991; or

(ii) a declaration stating that no native vegetation clearance under the Native Vegetation Act 1991 will be required as a result of the division of land; or

(iii) a report prepared in accordance with Regulation 18(2)(a) of the Native Vegetation Regulations 2017 that establishes that the vegetation to be cleared is categorised as 'low level clearance'.

(b) an application for land division is being considered concurrently with a proposal to develop each allotment which will satisfy, or would satisfy, the requirements of DTS / DPF 1.1, including any clearance that may occur; or

(c) the division is to support a Heritage Agreement under the Native Vegetation Act 1991 or the Heritage Places Act 1993.

Procedural Matters (PM)

Referrals

Class of Development / Activity Referral Body Purpose of Referral

Except where all of the relevant deemed-to-satisfy criteria are met, the following:

(a) all classes of development where a report prepared in accordance with Regulation 18(2)(a) of the Native Vegetation Regulations 2017 in connection with a development application categorises the clearance, or potential clearance, as 'major level clearance'.

Native Vegetation Council

To provide expert assessment and direction to the relevant authority on the potential impacts of development on native vegetation.

State Significant Native Vegetation Areas Overlay

Assessment Provisions (AP)

Desired Outcome (DO)

DO 1

Protect, retain and restore significant areas of native vegetation.

Performance Outcome (PO) • Deemed to Satisfy Criteria (DTS)

(required for development to be classified as Deemed-to-Satisfy)

- Designated Performance Feature (DPF)

(used for development to be assessed on its merits against the applicable policies of the Planning and Design Code)

Environmental Protection

PO 1.1

Development enhances biodiversity and habitat values through revegetation and avoiding native vegetation clearance except to promote an appreciation and awareness of wildlife areas, including visitor parking and amenities, or for the administration and management of a reserve or park established for the protection and conservation of wildlife.

DTS / DPF 1.1

An application is accompanied by:

- (a) a declaration stating that the proposal will not, or would not, involve clearance of native vegetation under the Native Vegetation Act 1991, including any clearance that may occur:
 - (i) in connection with a relevant access point and / or driveway;
 - (ii) within 10m of a building (other than a residential building or tourist accommodation);
 - (iii) within 20m of a dwelling or addition to an existing dwelling for fire prevention and control; and/or
 - (iv) within 50m of residential or tourist accommodation in connection with a requirement under a relevant overlay to establish an asset protection zone in a bushfire prone area; or

- (b) a report prepared in accordance with Regulation 18(2)(a) of the Native Vegetation Regulations 2017 that establishes that the clearance is categorised as 'low level clearance'.

Land division

PO 2.1

Land division that contributes to the conservation, protection and enhancement of native vegetation.

DTS / DPF 2.1

Land division to:

- (a) create a public road or a public reserve where the application is accompanied by a report prepared in accordance with Regulation 18(2)(a) of the Native Vegetation Regulations 2017 in which the extent of

native vegetation clearance proposed to be undertaken in connection with the division is categorised as 'low level clearance'; or

(b) realign allotment boundaries to incorporate land into a park or reserve established under the National Parks and Wildlife Act 1972.

Procedural Matters (PM)

Referrals

Class of Development / Activity Referral Body Purpose of Referral

Except where all of the relevant DTS / DPF are met, the following:

(a) land division where a report prepared in accordance with Regulation 18(2)(a) of the Native Vegetation Regulations 2017 in connection with a development application categorises the clearance, or potential clearance, as 'moderate level clearance' or 'major level clearance';

(b) all other classes of development. Native Vegetation Council

To provide expert assessment and direction to the relevant authority on the potential impacts of development on native vegetation.

Significant Industry Interface Overlay

Assessment Provisions (AP)

Desired Outcome (DO)

DO 1

Protection of state significant industrial activities by ensuring development has regard to potential environmental and amenity impacts generated by the lawful operation of proximate industry.

Performance Outcomes and Deemed to Satisfy / Designated Performance Outcome Criteria

Land Division

PO 1.1

Sensitive uses and sensitive receivers are:

- (d) located away from areas which may be subject to unacceptable noise, dust, odour or other emissions;
or
- (e) able to adequately mitigate impacts of noise, dust, odour or other dour emissions through design techniques such as:
 - i. locating residential accommodation the greatest distance practicable from the industry;
 - ii. locating buildings containing less non-sensitive receivers between the industry and sensitive receivers;
 - iii. placing rooms more sensitive to air, noise and odour impacts (e.g. bedrooms) further away from the industry; or
 - iv. providing private or common open space adjacent a building facade that shields the space from impacts of the industry

DTS/DPF 1.1

Development does not incorporate any of the following (including alterations and additions which increase the floor area of buildings accommodating the following by 10% or more):

- a. land division creating one or more additional allotments for residential purposes;
- b. dwelling;
- c. residential flat building
- d. tourist accommodation;
- e. boarding home;
- f. dormitory style accommodation;
- g. workers' accommodation;
- h. student accommodation;
- i. pre-school;
- j. educational establishment;
- k. retirement village; or
- l. supported accommodation;
- m. residential park; or
- n. hospital.

Procedural Matters (PM)

Referrals		
Class of Development / Activity	Referral Body	Purpose of Referral
None	None	None

Significant Landscape Protection Overlay

Assessment Provisions (AP)

Desired Outcome (DO)

DO 1

Conservation of the natural and rural character and scenic and cultural qualities of significant landscapes.

Performance Outcomes and Deemed to Satisfy / Designated Performance Outcome Criteria

Land Use and Intensity

PO 1.1

Land use intensity restrained to conserve and enhance natural and rural character.

DTS/DPF 1.1

None are applicable

PO 1.2

Development in the form of the following not undertaken:

- (a) renewable energy facilities;
- (b) large scale industry, storage, distribution, warehousing; and
- (c) intensive animal husbandry.

DTS/DPF 1.2

None are applicable

Built Form and Character

PO 2.1

Development carefully sited and designed to:

- (a) complement rural character;
- (b) minimise disruption to natural landform and integrate existing natural environmental features including, particularly, native vegetation;
- (c) minimise impacts on wildlife habitat;
- (d) be visually unobtrusive and blend in with the surrounding area; and
- (e) be located below ridge lines.

DTS/DPF 2.1

None are applicable

PO 2.2

Buildings and structures limited to those that:

- (a) are ancillary, adjacent to and of the same or lesser scale as existing buildings;

- (b) are essential in supporting existing pastoral or rural activities;
- (c) are used for the ancillary sale of produce associated with a pastoral or rural activity;
- (d) are in the form of high quality nature-based tourist accommodation;
- (e) are for rainwater storage;
- (f) are for research or education purposes; or
- (g) support conservation or the interpretation of the environment or cultural features.

DTS/DPF 2.2

None are applicable.

Landscaping

PO 3.1

Landscaping comprises locally indigenous species to enhance landscape quality and habitat restoration.

DTS/DPF 3.1

Landscaping plantings exclusively constitute locally indigenous plant species.

Earthworks

PO 4.1

Excavation and filling of land limited to that associated with:

- (a) minimising the visual impact of buildings or structures; or
- (b) construction of water storage facilities.

DTS/DPF 4.1

Excavation and/or filling:

- (a) is undertaken in order to reduce the visual impact of buildings or structures or to construct water storage facilities;
- (b) does not involve excavation exceeding a vertical height of 0.75m;
- (c) does not involve filling exceeding a vertical height of 0.75m;
- (d) does not involve a total combined excavation and filling vertical height of 1.5m; and
- (e) scree slopes are covered in topsoil and landscaped with locally indigenous plant species.

Procedural Matters (PM)

Referrals		
Class of Development / Activity	Referral Body	Purpose of Referral
None	None	None

Sloping Land Overlay

Assessment Provision (AP)

Desired Outcomes (DO)

DO 1

Development on sloping land designed to protect public safety, maintain and improve soil stability and minimise environmental and visual impacts.

Performance Outcomes and Deemed to Satisfy / Designated Performance Outcome Criteria

Land slip and Soil Erosion

PO 1.1

Development does not occur on land at risk of landslip or increase the potential for landslip or land surface instability.

DTS/DPF 1.1

None are applicable.

PO 1.2

Steep slopes stabilised through retention and replanting of vegetation.

DTS/DPF 1.2

None are applicable.

PO 1.3

Development includes site drainage systems that minimise erosion and avoid adverse impacts on slope stability.

DTS/DPF 1.3

None are applicable.

PO 1.4

Development avoids the alteration and obstruction of natural drainage lines.

DTS/DPF 1.4

None are applicable.

Visual Impacts

PO 2.1

Buildings sited and designed to integrate with the natural topography of the land using measures such as split level building construction and other approaches that minimise the extent of cut and fill.

DTS/DPF 2.1

None are applicable

Driveways and Access Tracks

PO 3.1

Driveways and access tracks are of a suitable gradient to allow safe and convenient access.

DTS/DPF 3.1

Driveways and access tracks do not have a gradient exceeding 25% (1-in-4) at any point along the driveway.

PO 3.2

Driveways and access tracks are of suitable construction to allow safe and convenient access.

DTS/DPF 3.2

Driveways and access tracks are constructed with an all-weather trafficable surface.

PO 3.3

Driveways and access tracks do not cause or contribute to the instability of embankments and cuttings.

DTS/DPF 3.3

None are applicable.

PO 3.4

Driveways and access tracks are sited and designed to integrate with the natural topography.

DTS/DPF 3.4

None are applicable.

PO 3.5

Driveways and access tracks provide level transition areas to enable safe movement of people and goods to and from the development.

DTS/DPF 3.5

None are applicable.

Earthworks

PO 4.1

Earthworks located outside townships and urban areas is limited and only undertaken to reduce the visual impact of buildings and structures and where it preserves the natural form of the land and native vegetation.

DTS/DPF 4.1

Development does not involve either:

(b) excavation exceeding a vertical height of 0.75m; or

(c) filling exceeding a vertical height of 0.75m;

and, if the development involves both excavation and filling, the total combined excavation and filling does not exceed a vertical height of 1.5m.

Procedural Matters (PM)

Referrals		
Class of Development / Activity	Referral Body	Purpose of Referral
None	None	None

State Heritage Place Overlay

Assessment Provisions (AP)

Desired Outcome (DO)

DO 1

Development maintains the heritage and cultural values of State Heritage Places through conservation, ongoing use and adaptive reuse.

Performance Outcomes and Deemed to Satisfy / Designated Performance Outcome Criteria

Built Form

PO 1.1

The form of new buildings and structures maintains the heritage values of the Place.

DTS 1.1

None are applicable.

PO 1.2

Massing and scale of development maintains the heritage values of the Place.

DTS 1.2

None are applicable.

PO 1.3

Design and architectural detailing maintains the heritage values of the Place.

DTS 1.3

None are applicable.

PO 1.4

Development is consistent with boundary setbacks and setting.

DTS 1.4

None are applicable.

PO 1.5

Materials and colours are either consistent with or complement the heritage values of the Place.

DTS 1.5

None are applicable.

PO 1.6

New buildings are not placed or erected between the front street boundary and the façade of a State Heritage Place.

DTS 1.6

None are applicable.

PO 1.7

Development of a State Heritage Place retains elements contributing to its heritage value.

DTS 1.7

None are applicable.

Alterations and Additions

PO 2.1

Alterations and additions complement the subject building and are sited to be unobtrusive, not conceal or obstruct heritage elements and detailing, or dominate the Place or its setting.

DTS 2.1

None are applicable.

Ancillary Development

PO 3.1

Ancillary development, including carports, outbuildings and garages, complement the heritage values of the Place.

DTS 3.1

None are applicable.

PO 3.2

Ancillary development, including carports, outbuildings and garages, is located behind the building line of the principal building(s).

DTS 3.2

None are applicable.

PO 3.3

Advertising and advertising hoardings are designed and located to complement the State Heritage Place, be unobtrusive, not conceal or obstruct heritage elements and detailing, or dominate the building or the setting.

DTS 3.3

None are applicable.

Land Division

PO 4.1

Land division creates allotments that:

- (a) are compatible with the surrounding pattern of subdivision of the State Heritage Place; and
- (b) are of a dimension to accommodate new development that reinforces and is compatible with the heritage values of the State Heritage Place.

DTS 4.1

None are applicable.

Landscape Context and Streetscape Amenity

PO 5.1

Individually heritage listed trees, parks, historic gardens and memorial avenues retained unless:

- (a) trees / plantings are, or have the potential to be, a danger to life or property; or
- (b) trees / plantings are significantly diseased and their life expectancy is short.

DTS 5.1

None are applicable.

Demolition

PO 6.1

State Heritage Places are not demolished, destroyed or removed in total or in part unless either of the following apply:

- (a) the portion of the Place to be demolished, destroyed or removed is excluded from the extent of listing that is of heritage value; or
- (b) the structural condition of the Place represents an unacceptable risk to public or private safety and results from actions and unforeseen events beyond the control of the owner and is irredeemably beyond repair.

DTS 6.1

None are applicable.

Conservation Works

PO 7.1

Conservation works to the exterior of a Place and other features of identified heritage value match existing materials to be repaired and utilise traditional work methods.

DTS 7.1

None are applicable.

Procedural Matters (PM)

Referrals		
Class of Development / Activity	Referral Body	Purpose of Referral
<p>Except where:</p> <ul style="list-style-type: none">(i) the development is to be undertaken in accordance with a Heritage Agreement under the <i>Heritage Places Act 1993</i>; or(ii) the development is, in the opinion of the relevant authority, minor in nature or like for like maintenance and would not warrant a referral when considering the purpose of the referral <p>the following forms of development:</p> <ul style="list-style-type: none">(a) demolition of internal or external significant building fabric;(b) freestanding advertisements, signs and associated structures that are visible from a public street, road or thoroughfare that abuts the State Heritage Place;(c) alterations or additions to buildings that:<ul style="list-style-type: none">(i) are visible from a public street, road or thoroughfare that abuts the State Heritage Place;(ii) may materially affect the context of a State Heritage Place; or(iii) involve substantive physical impact to the fabric of significant buildings;(d) new buildings that:<ul style="list-style-type: none">(i) are visible from a public street, road or thoroughfare that abuts the State Heritage Place; or	<p>The Minister responsible for administering the <i>Heritage Places Act 1993</i></p>	<p>To provide expert assessment and direction to the relevant authority on the potential impacts of development on State Heritage Places.</p>

Referrals

Class of Development / Activity	Referral Body	Purpose of Referral
<ul style="list-style-type: none">(ii) may materially affect the context of the State Heritage Place;(e) conservation repair works that are not representative of 'like for like' maintenance;(f) solar panels that are visible from a public street, road or thoroughfare that abuts the State Heritage Place;(g) land division;(h) the removal, alteration or installation of fencing where visible from a public street, road or thoroughfare that abuts the State Heritage Place; or(i) the removal of an individual tree or a tree within a garden or park of identified heritage significance.		

Strategic Infrastructure Gas Pipelines Overlay

Assessment Provisions (AP)

Desired Outcome (DO)

DO 1

Safe operation of high-pressure gas transmission pipelines and associated infrastructure.

Performance Outcomes and Deemed to Satisfy / Designated Performance Outcome Criteria

Land Division

PO 1.1

Land division preserves access to high pressure gas transmission pipelines for maintenance and emergency response purposes.

DTS/DPF 1.1

None are applicable.

Land Use

PO 2.1

Development maintains safe operation of high pressure gas transmission pipelines.

DTS/DPF 2.1

Development does not incorporate the following land uses:

- (a) educational establishment;
- (b) emergency services facility;
- (c) hospital;
- (d) industry;
- (e) pre-school;
- (f) retirement facility; or
- (g) supported accommodation.

Procedural Matters (PM)

Referrals		
Class of Development / Activity	Referral Body	Purpose of Referral
None	None	None

Urban Transport Routes Overlay

Assessment Provisions (AP)

Desired Outcomes (DO)

DO 1

Safe and efficient operation of urban transport routes for all road users.

DO 2

Provision of safe and efficient access to and from urban transport routes.

Performance Outcomes and Deemed to Satisfy / Designated Performance Outcome Criteria

Access – Safe Entry and Exit (Traffic Flow)

PO 1.1

Access points designed to allow safe entry and exit to and from a site to meet the needs of development, to ensure traffic flow interference associated with access movements is minimised.

DTS/DPF 1.1

An access point is designed to ensure:

- a. the following for the largest vehicle expected to access the site:
 - (i) entry and exit movements are left turn only;
 - (ii) access to and from the site is in a forward direction, with on-site manoeuvring available through circulation around the site of no more than a 3-point turn;
 - (iii) vehicles cross the property boundary at an angle between 70 and 90 degrees; and
 - (iv) access to and from the site fully within the kerbside lane of the road; and
- b. where the access point services, or is intended to service:
 - (i) a single dwelling, the access point has a width of between 3m and 4m (measured at the site boundary); or
 - (ii) between 2 and 6 dwellings, the access point has a width of between 6m and 7m (measured at the site boundary); or
 - (iii) over 6 dwellings or any other non-residential land use, then:
 - A. where vehicles 6.4m or less are expected to access the site, the access point has a width of between 7m and 10m (measured at the site boundary); or
 - B. where vehicles between 6.4m and 8.8m in length are expected to access the site, the access point has a width of between 12m and 16m (measured at the site boundary); or
 - C. where vehicles up to 12.5m in length are expected to access the site, the access point has a width of between 16m and 22m (measured at the site boundary); and
- c. the access point is located 1m or more from any roadside infrastructure or trees.

Access – On-Site Queuing

PO 2.1

Sufficient accessible on-site queuing adjacent to access points is provided to meet the needs of development so that all vehicle queues are contained fully within the boundaries of the development site, to minimise interruption on the functional performance of the road and safe vehicle movement.

DTS/DPF 2.1

An access point:

- (a) will not service, or is not intended to service, more than 6 dwellings and there are no internal driveways, intersections, car parking spaces or gates within 6.0m of the access point; or
- (b) will service development that will generate less than 60 vehicle movements per day; and
 - (i) where vehicles no greater than 6.4m in length are expected to access the site, there are no internal driveways, intersections, car parking spaces, car park isles or any other internal obstructions within 10.5m of the access point;
 - (ii) where vehicles between 6.4m and 8.8m in length are expected to access the site, there are no internal driveways, intersections, car parking spaces, car park isles or any other internal obstructions within 14.5m of the access point;

- (iii) where vehicles no greater than 12.5m in length are expected to access the site, there are no internal driveways, intersections, car parking spaces, car park isles or any internal obstructions within 20m of the access point; or
- (iv) where vehicles over 12.5m in length are expected to access the site, no Deemed-to-Satisfy Criteria applies.

Access - Existing Access Point

PO 3.1

Existing access points designed to accommodate the type and volume of traffic likely to be generated by the development.

DTS/DPF 3.1

An existing access point:

- (a) will not service and is not intended to service more than 6 dwellings; or
- (b) will service development that will not result in:
 - (i) an increase in traffic using an existing access point that is 10% greater than the traffic volumes using the existing access prior to the development or 60 vehicles per day (whichever is the lesser); or
 - (ii) a larger class of vehicle expected to access the site using the existing access.

Access – Location (Spacing)

PO 4.1

New access points are widely spaced apart from any existing access point or public road junction to not impede traffic flow and ensure safe and efficient road operating conditions.

DTS/DPF 4.1

Where access from an alternative local road at least 25m from the Urban Route is not available, and the access is not located on a Controlled Access Road, a new access point is:

- a. not located on a section affected by double barrier lines between either edge of the access point; and
- b. at least the following distance from a public road junction, or terminating / merging lane on a public road:
 - (a) 110 km/h road – 190m
 - (b) 100 km/h road – 165m
 - (c) 90 km/h road – 140m
 - (d) 80 km/h road – 110m
 - (e) 70 km/h road – 90m
 - (f) 60 km/h road – 70m
 - (g) 50km/h or less road – 50m; and
- c. at least the following distance from another private (non-public road) access point:
 - (a) 110 km/h road – 130m
 - (b) 100 km/h road – 105m
 - (c) 90 km/h road – 85m
 - (d) 80 km/h road – 70m
 - (e) 70 km/h road – 55m
 - (f) 60 km/h road – 40m
 - (g) 50km/h or less road – 30m

Access – Location (Sight Lines)

PO 5.1

Access points located and designed to ensure appropriate sight distances are provided so that drivers:

- (a) on the road approaching the access point are able to recognise the presence of the access point and/or see a vehicle turning into or out of the access point in time to slow down or stop in a safe and controlled manner; and
- (b) exiting the access point onto the road can see approaching vehicles to avoid potential conflict.

DTS/DPF 5.1

Drivers approaching or exiting a new access point have an unobstructed line of sight to or from the new access point in accordance with the following distances:

- (a) 110 km/h road – 325m
- (b) 100 km/h road – 280m
- (c) 90 km/h road – 240m
- (d) 80 km/h road – 200m
- (e) 70 km/h road – 165m
- (f) 60 km/h road – 135m; and
- (g) 50km/h or less road – 105m.

Procedural Matters (PM)

Referrals		
Class of Development / Activity	Referral Body	Purpose of Referral
Except where all of the relevant deemed-to-satisfy criteria are met, development (including the division of land) that: (a) creates a new access or junction; or (b) proposes either of the following (except where deemed to be minor in the opinion of the relevant authority): (i) alters an existing access or public road junction; or (ii) may change the nature of vehicular movements or increase the number or frequency of movements through an existing access; on an Urban Traffic Route road or within 25m of an intersection with such a road.	Commissioner of Highways	To provide expert technical assessment and direction to the Relevant Authority on the safe and efficient operation and management of all roads relevant to the Commissioner of Highways as described in the Planning and Design Code.

Water Resources Overlay

Assessment Provisions (AP)

Desired Outcome (DO)

DO 1

Protection of the quality of surface waters.

Performance Outcomes and Deemed to Satisfy / Designated Performance Outcome Criteria

Water Catchment

PO 1.1

Watercourses and their beds, banks, wetlands and floodplains are not damaged or modified and are retained in their natural state, except where modification is required for essential access or maintenance purposes.

DTS/DPF 1.1

None are applicable.

PO 1.2

Development avoids interfering with the hydrology or water regime of swamps and wetlands.

DTS/DPF 1.2

None are applicable.

PO 1.3

Wetlands and low-lying areas providing habitat for native flora and fauna are not drained, except temporarily for essential management purposes to enhance environmental values.

DTS/DPF 1.3

None are applicable.

PO 1.4

Along watercourses, areas of remnant native vegetation, or areas prone to erosion, that are capable of natural regeneration are fenced off to limit stock access.

DTS/DPF 1.4

None are applicable.

PO 1.5

Development that increases surface water run-off includes a suitably sized strip of vegetated land on each side of a watercourse to filter runoff so as to:

- (a) reduce the impacts on native aquatic ecosystems; and
- (b) minimise soil loss eroding into the watercourse.

DTS/DPF 1.5

A strip of land 20m or more wide measured from the top of existing banks on each side of the watercourse is free from development, livestock use and revegetated with locally indigenous vegetation.

PO 1.6

Development resulting in the depositing or placing of an object or solid material in a watercourse or lake only occurs where it involves:

- (a) the construction of an erosion control structure;
- (b) devices or structures used to extract or regulate water flowing in a watercourse;
- (c) devices used for scientific purposes; or
- (d) the rehabilitation of watercourses.

DTS/DPF 1.6

None are applicable.

PO 1.7

Watercourses, floodplains and wetlands protected and enhanced by retaining and protecting existing native vegetation.

DTS/DPF 1.7

None are applicable.

PO 1.8

Watercourses, floodplains and wetlands protected and enhanced by stabilising watercourse banks and reducing sediments and nutrients entering the watercourse.

DTS/DPF 1.8

None are applicable.

PO 1.9

Dams, water tanks and diversion drains are located and constructed to maintain the quality and quantity of flows required to meet environmental and downstream needs.

DTS/DPF 1.9

None are applicable.

Procedural Matters (PM)

Referrals		
Class of Development / Activity	Referral Body	Purpose of Referral
None	None	None

Part 4 – General Development Policies

Advertisements

Assessment Provisions (AP)

Desired Outcome (DO)

DO 1

Advertisements and advertising hoardings are designed appropriate to context, are efficient and effective in communicating with the public, are limited in number to avoid clutter, and do not create hazard.

Performance Outcomes and Deemed to Satisfy / Designated Performance Outcome Criteria

Appearance

PO 1.1

Advertisements are compatible and integrated with the design of the building and/or land they are located on.

DTS/DPF 1.1

Advertisements attached to a building:

- (b) if located below canopy level, are flush with a wall;
- (c) if located at canopy level, are in the form of a fascia sign;
- (d) if located above a canopy:
 - i. are flush with a wall;
 - ii. do not have any part rising above parapet height; and
 - iii. are not attached to the roof of the building.
- (e) if attached to the side of a verandah, do not exceed the width of the verandah or project from the verandah;
- (f) if attached to the front of a verandah, do not exceed the length of the verandah or project from the verandah;
- (g) if attached to a two storey building, have no part located above the finished floor level of the second storey of the building; and
- (h) where they are flush with a wall, do not, in combination with any other existing sign, cover more than 15% of the building facade to which they are attached.

PO 1.2

Advertisements designed to conceal their supporting advertising hoarding from view.

DTS 1.2

None are applicable.

PO 1.3

Advertising located so as to not encroach on public land or the land of an adjacent allotment.

DTS/DPF 1.3

Advertisements and/or advertising hoardings are:

- (a) completely contained within the boundaries of the site; or
- (b) if a road widening is applicable, advertising and/or advertising hoarding are completely contained within the proposed property boundary realignment.

PO 1.4

Where possible advertisements on public land are integrated with existing structures and infrastructure.

DTS/DPF 1.4

An advertisement on public land:

- (a) achieves Advertisements DTS/DPF 1.1; or
- (b) is integrated with a bus shelter and it is not to be illuminated.

PO 1.5

Advertisements and/or advertising hoarding of a scale and size appropriate to the character of the locality.

DTS / DPF 1.5

Advertising and/or advertising hoardings meet the area and height requirements set out in [Advertisements Table 1 – Maximum Size and Height Requirements](#)

Proliferation of Advertisements

PO 2.1

Proliferation of advertisements minimised to avoid visual clutter and untidiness.

DTS/DPF 2.1

No more than one advertisement is displayed on each public road per occupancy.

PO 2.2

Multiple-business or activity advertisements co-located and coordinated to avoid visual clutter and untidiness.

DTS/DPF 2.2

Advertisements for multiple-business or activity complex incorporating information regarding each business or activity in a single advertisement fixture or structure.

Advertising Content

PO 3.1

Content of advertisements primarily limited to information relating to the lawful use of land they are located on.

DTS/DPF 3.1

An advertisement does not contain third party content.

Amenity Impacts

PO 4.1

Light spill from advertisement illumination does not unreasonably compromise amenity of adjacent and proximate sensitive receivers.

DTS/DPF 4.1

An advertisement does not incorporate any illumination.

Safety

PO 5.1

Advertisements and/or advertising hoardings erected on a verandah or project from a building wall designed and located to allow for safe and convenient pedestrian access.

DTS/DPF 5.1

An advertisement with a minimum clearance of 2.5m between the top of the footway and base of the underside of the sign.

PO 5.2

Advertisements and/or advertising hoardings do not distract or create a hazard to drivers through excessive illumination.

DTS/DPF 5.2

No advertisement illumination is proposed.

PO 5.3

Advertisements and/or advertising hoardings do not create a hazard to drivers by:

- (a) being liable to interpretation by drivers as an official traffic sign or signal;
- (b) obscuring or impairing a driver's view of official traffic signs or signals; or
- (c) obscuring or impairing a driver's view of features of a road that are potentially hazardous (such as junctions, bends, changes in width and traffic control devices) or other road or rail vehicles at/or approaching level crossings.

DTS/DPF 5.3

DTS/DPF 1.1, 1.2, 5.1, 5.2 and 5.5 are met.

PO 5.4

Advertisements and/or advertising hoardings do not create a hazard by distracting drivers from the primary driving task at a location where the demands on driver concentration are high.

DTS/DPF 5.4

An advertisement and/or advertising hoarding not located along or adjacent to a road having a speed limit of 80km/h or more.

PO 5.5

Advertisements and/or advertising hoardings provide sufficient clearance from the road carriageway to allow for safe and convenient movement by all road users

DTS/DPF 5.5

Where the advertisement or advertising hoarding is:

- (a) on a kerbed road with a speed zone of 60km/h or less, the advertisement or advertising hoarding is located at least 0.6m from the roadside edge of the kerb;
- (b) on an unkerbed road with a speed zone of 60km/h or less, the advertisement or advertising hoarding is located at least 5.5m from the edge of the seal; or
- (c) on any other kerbed or unkerbed road, the advertisement or advertising hoarding is located a minimum of the following distance from the roadside edge of the kerb or the seal:
 - i. 110 km/h road – 14m
 - ii. 100 km/h road – 13m
 - iii. 90 km/h road – 10m
 - iv. 70 or 80 km/h road – 8.5m

Table 1 – Maximum Size and Height Requirements

Advertisements and Advertising Hoardings			
P&D Code Zone	Type of Advertisement	Advertised area	Maximum height (metres)
Urban Activity Centre Suburban Activity Centre	Attached to building	Does not exceed 25 per cent of the ground floor wall area on the façade the sign is placed	N/A
	Freestanding	does not exceed 5m ² per side	8
Township Activity Centre	Attached to building	X	N/A
	Freestanding	Sign face does not exceed 5m ² per side	6
Suburban Main Street	Attached to building	X	N/A
	Freestanding	Sign face does not exceed 4m ² per side	6
Township Main Street	Attached to building	X	X
	Freestanding	X	X
Suburban Business and Innovation Business Neighbourhood	Attached to building	Does not exceed 25 per cent of the ground floor wall area on the façade the sign is placed	N/A
	Freestanding	X	X
Employment	Attached to building	X	N/A
	Freestanding	Sign face does not exceed 8m ² per side	6
Suburban Employment	Attached to building	X	N/A
	Freestanding	X	X
City Living	Attached to building	no greater than 0.2 square metres in area, with the exception of the Wellington Square frontages of non-residential sites in the south eastern part of the Square (sited between 2 and 38 Wellington Square,	N/A

P&D Code Zone	Type of Advertisement	Advertised area	Maximum height (metres)
		where larger advertisements may be appropriate	
	Freestanding	no greater than 0.2 square metres in area, with the exception of the Wellington Square frontages of non-residential sites in the south eastern part of the Square (sited between 2 and 38 Wellington Square, where larger advertisements may be appropriate	X
Urban Corridor (Boulevard) Urban Corridor (Business) Urban Corridor (Living) Urban Corridor (Main Street)	Attached to building	Does not exceed 25 per cent of the ground floor wall area on the façade the sign is placed	X
	Freestanding	X	X
Rural	Attached to building	2m ²	X
Horticulture Viticulture	Freestanding	2m ²	X
Peri-Urban	Attached to building	X	X
	Freestanding	X	X
Township	Attached to building	X	X
Settlement	Freestanding	X	X
	Attached to building	X	X
Urban Neighbourhood	Freestanding	X	X
Capital City	Attached to building	X	X
City Main Street	Freestanding	X	X

P&D Code Zone	Type of Advertisement	Advertised area	Maximum height (metres)
Home Industry	Attached to building	X	X
	Freestanding	X	X
Neighbourhood	Attached to building	X	X
Rural Living etc.	Freestanding	X	X

Animal Keeping and Horse Keeping

Assessment Provisions (AP)

Desired Outcomes (DO)

DO 1

Animals kept at a density that is not beyond the carrying capacity of the land and in a manner that minimises adverse effects on the environment, local amenity and surrounding development.

Performance Outcomes and Deemed to Satisfy / Designated Performance Outcome Criteria

Siting and Design

PO 1.1

Animal keeping, horse keeping and associated activities do not create adverse impacts on the environment or the amenity of the locality.

DTS/DPF 1.1

None are applicable

PO 1.2

Animal keeping and horse keeping located and managed to minimise the potential transmission of disease to other operations where animals are kept.

DTS/DPF 1.2

None are applicable

Horse Keeping

PO 2.1

Water from stable wash-down areas directed to appropriate absorption areas and/or drainage pits to minimise pollution of land and water.

DTS/DPF 2.1

None are applicable

PO 2.2

Stables, horse shelters or associated yards sited appropriate distances away from sensitive receivers and/or allotments in other ownership to avoid adverse impacts from dust, erosion and odour.

DTS/DPF 2.2

None are applicable

Stables, horse shelters and/or associated yards sited in accordance with the following:

- (a) 30m or more from any sensitive receivers or approved sensitive receivers on land in other ownership;
- (b) where an adjacent allotment is vacant and in other ownership, 30m or more from the boundary of that allotment.

PO 2.3

All areas accessible to horses separated from septic tank effluent disposal areas to protect the integrity of that system. Kennel flooring constructed with an impervious material to facilitate regular cleaning.

DTS/DPF 2.3

Septic tank effluent disposal areas enclosed with a horse proof barrier such as a fence to exclude horses from this area.

PO 2.4

To minimise environmental harm and adverse impacts on water resources, stables, horse shelters or associated yards are appropriately setback from a watercourse.

DTS/DPF 2.4

Stables, horse shelters or associated yards setback 50m or more from a watercourse

PO 2.5

Stables, horse shelters or associated yards are established on slopes that are stable to minimise risk of soil erosion and water run-off.

DTS/DPF 2.5

Stables, horse shelters or associated yards not located on land with a slope greater than 10% (1-in-10).

Kennels

PO 3.1

Kennel flooring constructed with an impervious material to facilitate regular cleaning.

DTS/DPF 3.1

The floor of kennels:

- (a) constructed of impervious concrete; and
- (b) designed to be self-draining when washed down.

PO 3.2

Kennels and exercise yards designed and sited to minimise noise nuisance to neighbours through measures such as:

- (a) adopting appropriate separation distances; and
- (b) orientating openings away from sensitive receivers.

DTS/DPF 3.2

Kennels sited 500m or more from the nearest sensitive receiver on land in other ownership.

PO 3.3

Dogs are regularly observed and managed to minimise nuisance impact on adjoining sensitive receivers from animal behaviour.

DTS/DPF 3.3

Kennels sited in association with a permanent dwelling on the land.

Wastes

PO 4.1

Storage of manure, used litter and other wastes (other than waste water lagoons) is sited, designed, constructed and managed to:

- (a) avoid attracting and harbouring vermin;
- (b) avoid polluting water resources; and
- (c) be located outside 1% AEP flood event areas.

DTS/DPF 4.1

None are applicable

Aquaculture

Assessment Provisions (AP)

Desired Outcomes (DO)

DO 1

Development of aquaculture facilities in an ecologically, economically and socially sustainable manner to support a fair and equitable sharing of marine, coastal and inland resources and mitigate conflict with other water-based and land-based uses.

Performance Outcomes and Deemed to Satisfy / Designated Performance Outcome Criteria

Land Based Aquaculture

PO 1.1

Land-based aquaculture and associated components sited and designed to avoid adverse impacts on nearby sensitive receivers.

DTS/DPF 1.1

Land-based aquaculture and associated components located:

- (a) 200m or more from a sensitive receiver in other ownership; or
- (b) 500m or more from the boundary of a zone primarily intended to accommodate sensitive receivers.

PO 1.2

Land-based aquaculture and associated components sited and designed to prevent surface flows from entering ponds in a 1% AEP sea flood level event.

DTS/DPF 1.2

None are applicable.

PO 1.3

Land-based aquaculture and associated components sited and designed to prevent pond leakage that would pollute groundwater.

DTS/DPF 1.3

None are applicable.

PO 1.4

Land-based aquaculture and associated components sited and designed to prevent farmed species escaping and entering into any waters.

DTS/DPF 1.4

None are applicable.

PO 1.5

Land-based aquaculture and associated components, including intake and discharge pipes, designed to minimise the need to traverse sensitive areas to minimise impact on the natural environment.

DTS/DPF 1.5

None are applicable.

PO 1.6

Pipe inlet and outlets associated with land-based aquaculture sited and designed to minimise the risk of disease transmission.

DTS/DPF 1.6

None are applicable.

PO 1.7

Storage areas associated with aquaculture activity integrated with the use of the land and sited and designed to minimise visual impact on the surrounding environment.

DTS/DPF 1.7

None are applicable.

Marine Based Aquaculture

PO 2.1

Marine aquaculture sited and designed to minimise adverse impacts on sensitive ecological areas including:

- (a) creeks, and estuaries;
- (b) wetlands;
- (c) significant seagrass and mangrove communities; and
- (d) marine habitats and ecosystems.

DTS/DPF 2.1

None are applicable.

PO 2.2

Marine aquaculture sited in areas with adequate water current to disperse sediments to prevent the build-up of waste.

DTS/DPF 2.2

None are applicable.

PO 2.3

Marine aquaculture incorporates measures to ensure satisfactory removal and disposal of litter, disused material, shells, debris, detritus, dead animals and animal waste from the development to prevent pollution of waters, wetlands, or the nearby coastline.

DTS/DPF 2.3

None are applicable.

PO 2.4

Marine aquaculture designed to not involve discharge of human waste on the site, on any adjacent land or into nearby waters.

DTS/DPF 2.4

None are applicable

PO 2.5

Marine aquaculture (other than inter-tidal aquaculture) located an appropriate distance seaward of the high water mark.

DTS/DPF 2.5

Marine aquaculture development located 100m or more seaward of the high water mark.

PO 2.6

Marine aquaculture sited and designed to not obstruct or interfere with:

- (a) areas of high public use;
- (b) areas, including beaches, used for recreational activities such as swimming, fishing, skiing, sailing and other water sports.

DTS/DPF 2.6

None are applicable

PO 2.7

Marine aquaculture sited and designed to minimise interference and obstruction to the natural processes of the coastal and marine environment.

DTS/DPF 2.7

None are applicable

PO 2.8

Marine aquaculture sited and designed at a sufficient height above the sea floor and in a manner to minimise seabed damage.

DTS/DPF 2.8

None are applicable

PO 2.9

Marine aquaculture designed to be as unobtrusive as practicable by incorporating measures such as:

- (a) using feed hoppers that are painted in subdued colours and suspended as close as possible to the water surface;
- (b) positioning of structures to protrude the minimum distance practicable above the water surface;
- (c) avoiding the use of shelters and structures above cages and platforms unless necessary to exclude predators and protected species from interacting with the farming structures and/or stock inside the cages, or for safety reasons; and
- (d) positioning racks, floats and other farm structures in visually unobtrusive locations from the shoreline.

DTS/DPF 2.9

None are applicable

PO 2.10

Access, launching and maintenance facilities utilise existing established roads, tracks, ramps and paths to or from the sea where possible.

DTS/DPF 2.10

None are applicable

PO 2.11

Access, launching and maintenance facilities developed as common user facilities and co-located where practicable to mitigate adverse impacts on coastal areas.

DTS/DPF 2.11

None are applicable

PO 2.12

Marine aquaculture sited to minimise potential impacts on, and to protect the integrity of, reserves under the *National Parks and Wildlife Act 1972*.

DTS/DPF 2.12

Marine aquaculture located 1000m or more seaward of the boundary of any reserve under the *National Parks and Wildlife Act 1972*.

PO 2.13

Onshore storage, cooling and processing facilities that do not impair the coastline and its visual amenity and:

- (a) sited, designed, landscaped and developed at a scale and using external materials to minimise any adverse visual impact on the coastal landscape;
- (b) sited and designed with appropriate vehicular access arrangement; and
- (c) incorporate appropriate waste treatment and disposal.

DTS/DPF 2.13

None are applicable

Navigation and Safety

PO 3.1

Marine aquaculture sites are suitably marked to maintain navigational safety.

DTS/DPF 3.1

None are applicable

PO 3.2

Marine aquaculture sited to provide adequate separation between farms for safe navigation.

DTS/DPF 3.2

None are applicable

PO 3.3

Structures secured and/or weighted to prevent drifting from the licensed site.

DTS/DPF 3.3

None are applicable

Environmental Management

PO 4.1

Marine aquaculture is maintained to prevent hazards to people and wildlife, including breeding grounds and habitats of native marine mammals and terrestrial fauna, especially migratory species.

DTS/DPF 4.1

None are applicable

PO 4.2

Marine aquaculture designed to facilitate the relocation or removal of structures in the case of emergency such as oil spills, algal blooms and altered water flows.

DTS/DPF 4.2

None are applicable

PO 4.3

Marine aquaculture that provides for progressive or future reclamation of disturbed areas ahead of, or upon, decommissioning.

DTS/DPF 4.3

None are applicable

Beverage Production in Rural Areas

Assessment Provisions (AP)

Desired Outcome (DO)

DO 1

Mitigation of potential amenity and environmental impacts of value-adding beverage production facilities such as wineries, distilleries, cideries and breweries.

Performance Outcomes and Deemed to Satisfy / Designated Performance Outcome Criteria

Odour and Noise

PO 1.1

Beverage production activities are designed and sited to minimise odour impacts on amenity.

DTS/DPF 1.1

None are applicable

PO 1.2

Beverage production activities are designed and sited to minimise noise impacts on sensitive receivers.

DTS/DPF 1.2

None are applicable

PO 1.3

Fermentation, distillation, manufacturing, storage, packaging and bottling activities occur within enclosed buildings.

DTS/DPF 1.3

None are applicable

PO 1.4

Breweries designed to minimise odours emitted during boiling and fermentation stages of production.

DTS/DPF 1.4

Brew kettles are fitted with a vapour condenser.

PO 1.5

Beverage production solid wastes stored in a manner that minimises odour impacts on sensitive receivers in other ownership.

DTS/DPF 1.5

Solid waste is collected and stored in sealed containers and removed from the site within 48 hours.

Water Quality

PO 2.1

Beverage production wastewater management systems (including wastewater irrigation) setback from watercourses to minimise adverse impacts on water resources.

DTS/DPF 2.1

Wastewater management systems are setback 50m or more from the banks of watercourses and bores.

PO 2.2

Water resources are protected from pollution by ensuring development does not involve the storage or disposal of chemicals or hazardous substances in a manner that would pose a water pollution risk.

DTS/DPF 2.2

None are applicable

PO 2.3

Stormwater run-off from areas subject to contamination by beverage production activities (including vehicle movements and machinery operations) is drained to an onsite stormwater treatment system.

DTS/DPF 2.3

None are applicable

PO 2.4

Stormwater run-off from areas not likely to be subject to contamination by beverage production and associated activities (such as roof catchments and clean hard paved surfaces) is diverted away from beverage production areas and wastewater management systems.

DTS/DPF 2.4

None are applicable

Wastewater Irrigation

PO 3.1

Beverage production wastewater irrigation systems designed and located to not contaminate soil and surface and ground water resources or damage crops.

DTS/DPF 3.1

None are applicable

PO 3.2

Beverage production wastewater irrigation systems designed and located to minimise impact on amenity and avoid spray drift onto adjoining land.

DTS/DPF 3.2

Beverage production wastewater is not irrigated within 50 metres of any dwelling in other ownership.

PO 3.3

Beverage production wastewater is not irrigated onto:

- (a) waterlogged areas;
- (b) land within 50 metres of a creek, swamp or domestic or stock water bore;
- (c) land subject to flooding;
- (d) steeply sloping land; or
- (e) rocky or highly permeable soil overlaying an unconfined aquifer.

DTS/DPF 3.3

None are applicable

Bulk Handling and Storage Facilities

Assessment Provisions (AP)

Desired Outcomes (DO)

DO 1

Facilities for the bulk handling and storage of agricultural, mineral, petroleum, rock, ore or other similar commodities designed to minimise adverse impacts on transport networks, the landscape and surrounding land uses.

Performance Outcomes and Deemed to Satisfy / Designated Performance Outcome Criteria

Siting and Design

PO 1.1

Bulk handling and storage facilities sited and designed to minimise risks of adverse air quality and noise impacts on sensitive receivers.

DTS/DPF 1.1

Facilities for the handling, storage and dispatch of commodities in bulk (excluding processing), meet the following minimum separation distances from sensitive receivers:

- (a) bulk handling of agricultural crop products, rock, ores, minerals, petroleum products or chemicals at a wharf or wharf side facility: 300m or more
- (b) bulk petroleum storage: 500m or more
- (c) coal handling with:
 - i. capacity up to 1 tonne per day or a storage capacity up to 50 tonnes: 500m or more
 - ii. capacity exceeding 1 tonne per day or a storage capacity exceeding 50 tonnes: 1,000m or more.

Buffers and Landscaping

PO 2.1

Bulk handling and storage facilities incorporate a buffer area for the establishment of dense landscaping adjacent road frontages.

DTS/DPF 2.1

None are applicable

PO 2.2

Bulk handling and storage facilities incorporate landscaping to assist with screening and dust filtration.

DTS/DPF 2.2

None are applicable

Access and Parking

PO 3.1

Roadways and vehicle parking areas associated with bulk handling and storage facilities designed and surfaced to control dust emissions and drag out of material from the site.

DTS/DPF 3.1

Roadways and vehicle parking areas are sealed with an all-weather surface.

Slipways, Wharves and Pontoons

PO 4.1

Slipways, wharves and pontoons used for the handling of bulk materials (such as fuel, oil, catch, bait and the like) incorporate catchment devices to avoid the release of materials into adjacent waters.

DTS/DPF 4.1

None are applicable.

Clearance from Overhead Powerlines

Assessment Provisions (AP)

Desired Outcome (DO)

DO 1

Protection of human health and safety when undertaking development in the vicinity of overhead transmission powerlines.

Performance Outcomes and Deemed to Satisfy / Designated Performance Outcome Criteria

PO 1.1

Buildings are adequately separated from aboveground powerlines to minimise potential hazard to people and property.

DTS/DPF 1.1

One of the following is satisfied:

- (a) a declaration is provided by or on behalf of the applicant to the effect that the proposal would not be contrary to the regulations prescribed for the purposes of section 86 of the *Electricity Act 1996*; or
- (b) there are no above ground powerlines adjoining the site that is the subject of the proposed development.

Design in Urban Areas

Assessment Provisions (AP)

Desired Outcome (DO)

DO 1

Development that is:

- (a) contextual – by considering, recognising and carefully responding to its natural surroundings and positively contributing to the character of the immediate area;
- (b) durable – fit for purpose, adaptable and long lasting;
- (c) inclusive – by integrating landscape design to optimise pedestrian and cyclist usability, privacy and equitable access, and also promote the provision of quality spaces integrated with the public realm that can be used for access and recreation and help optimise security and safety both internally and within the public realm, for occupants and visitors alike; and
- (d) sustainable – by integrating sustainable techniques into the design and siting of development and landscaping to improve community health, urban heat, water management, environmental performance, biodiversity and local amenity and to minimise energy consumption.

Performance Outcomes and Deemed to Satisfy / Designated Performance Outcome Criteria

ALL DEVELOPMENT

External Appearance

PO 1.1

Buildings that reinforce corners through changes in setback, articulation, materials, colour and massing (including height, width, bulk, roof form and slope).

DTS 1.1

None are applicable.

PO 1.2

Where zero or minor setbacks are desirable, development provides shelter over footpaths to positively contribute to the walkability and comfort of the public realm.

DTS 1.2

None are applicable.

PO 1.3

Buildings (other than ancillary buildings, group dwellings or buildings on a battle-axe allotment) designed so the main façade faces the primary street frontage of the land on which they are situated.

DTS 1.3

None are applicable.

PO 1.4

Plant, exhaust and intake vents and other technical equipment integrated into the building design to minimise visibility from the public realm and negative impacts on residential amenity by:

- (a) positioning plant and equipment discretely, in unobtrusive locations as viewed from public roads and spaces;
- (b) screening rooftop plant and equipment from view; and
- (c) when located on the roof of non-residential development, locating the plant and equipment as far as practicable from adjacent sensitive land uses.

DTS / DPF 1.4

Development does not incorporate any structures that protrude beyond the roofline.

PO 1.5

The negative visual impact of outdoor storage, waste management, loading and service areas is minimised by integrating them into the building design and screening them from public view (such as fencing, landscaping and built form) taking into account the form of development contemplated in the relevant zone.

DTS 1.5

None are applicable.

Safety

PO 2.1

Development maximises opportunities for passive surveillance of the public realm by providing clear lines of sight, appropriate lighting and the use of visually permeable screening wherever practicable.

DTS 2.1

None are applicable.

PO 2.2

Development designed to differentiate public, communal and private areas.

DTS 2.2

None are applicable.

PO 2.3

Buildings designed with safe, perceptible and direct access from public street frontages and vehicle parking areas.

DTS 2.3

None are applicable.

PO 2.4

Development at street level designed to maximise opportunities for passive surveillance of adjacent public realm.

DTS 2.4

None are applicable.

PO 2.5

Common areas and entry points of buildings (such as the foyer areas of residential buildings), and non-residential land uses at street level, maximise passive surveillance from the public realm to the inside of the building at night.

DTS 2.5

None are applicable.

Landscaping**PO 3.1**

Landscaped (including trees), permeable open spaces incorporated to:

- (a) minimise heat absorption and reflection;
- (b) maximise shade and shelter;
- (c) maximise stormwater infiltration; and
- (d) enhance the appearance of land and streetscapes.

DTS 3.1

None are applicable.

Environmental Performance**PO 4.1**

Buildings sited, oriented and designed to maximise natural sunlight access and ventilation to main activity areas, habitable rooms, common areas and open spaces.

DTS 4.1

None are applicable.

PO 4.2

Buildings sited and designed to maximise passive environmental performance and minimise energy consumption and reliance on mechanical systems, such as heating and cooling.

DTS 4.2

None are applicable.

PO 4.3

Buildings incorporate climate responsive techniques and features such as building and window orientation, use of eaves, verandahs and shading structures, water harvesting, at ground landscaping, green walls, green roofs and photovoltaic cells.

DTS 4.3

None are applicable.

Water Sensitive Design

PO 5.1

Development sited and designed to maintain natural hydrological systems without negatively impacting:

- (a) the quantity and quality of surface and groundwater;
- (b) the depth and directional flow of surface and groundwater; or
- (c) the quality and function of natural springs.

DTS 5.1

None are applicable.

Car parking appearance

PO 6.1

Development facing the street designed to minimise the negative impacts of any semi-basement and under-croft car parking on streetscapes.

DTS/DPF 6.1

The protrusion of semi-basement and undercroft car parking structures does not exceed 1.2m above finished ground level and is screened through appropriate plantings, except in a location or zone where a continuous ground floor façade aligned with the front property boundary is desired.

PO 6.2

Vehicle parking areas appropriately located, designed and constructed to minimise impacts on adjacent sensitive receivers through measures such as ensuring they are attractively developed and landscaped, screen fenced, and the like.

DTS 6.2

None are applicable.

PO 6.3

Pedestrian connections that are safe, legible, direct and accessible are provided between parking areas and the development.

DTS 6.3

None are applicable.

PO 6.4

Street level vehicle parking areas that are open to the sky are landscaped to provide shade and reduce solar heat absorption and reflection.

DTS / DPF 6.4

Vehicle parking areas that are open to the sky and comprise 10 or more car parking spaces include a shade tree with a mature canopy of 4m diameter spaced for each 10 car parking spaces provided and a landscaped strip on any road frontage of a minimum dimension of 1m.

PO 6.5

Vehicle parking areas are landscaped along public frontages, allotment boundaries and between double rows of parking spaces.

DTS / DPF 6.5

Vehicle parking areas comprising 10 or more car parking spaces contain a vegetated landscaped strip of a minimum dimension of:

- (a) 1m along all public road frontages and allotment boundaries; and
- (b) 0.6m between double rows of car parking spaces.

PO 6.6

Vehicle parking areas and associated driveways are landscaped to shade and positively contribute to amenity.

DTS 6.6

None are applicable.

PO 6.7

Vehicle parking areas and accessways incorporate integrated stormwater management techniques such as permeable or porous surfaces, infiltration systems, drainage swales or rain gardens that integrate with landscaping requirements.

DTS 6.7

None are applicable.

Earthworks

PO 7.1

Development, including any associated driveways and access tracks, minimises the need for earthworks to limit disturbance to natural topography.

DTS / DPF 7.1

Development does not involve either:

- (a) excavation exceeding a vertical height of 1m;
- (b) filling exceeding a vertical height of 1m; or
- (c) a total combined excavation and filling vertical height of 2m or more.

Fences and walls

PO 8.1

Fences, walls and retaining walls of sufficient height to maintain privacy and security without unreasonably impacting visual amenity and adjoining land's access to sunlight.

DTS 8.1

None are applicable.

PO 8.2

Landscaping incorporated on the low side of retaining walls that are visible from public roads and public open space to minimise visual impacts.

DTS / DPF 8.2

A vegetated landscaped strip 500mm deep or more is provided against the low side of a retaining wall.

ALL DEVELOPMENT - 4 OR MORE BUILDING LEVELS

External Appearance

PO 9.1

Buildings positively contribute to the character of the local area by responding to local context.

DTS 9.1

None are applicable.

PO 9.2

Fine-grain detail at street level and a mixture of materials at lower building levels near the public interface are provided to reinforce a human scale.

DTS 9.2

None are applicable.

PO 9.3

Buildings designed to reduce visual mass by breaking up building façades into distinct elements.

DTS 9.3

None are applicable.

PO 9.4

Boundary walls visible from public land include visually interesting treatments to break up large blank elevations.

DTS 9.4

None are applicable.

PO 9.5

External materials and finishes are durable and age well to minimise ongoing maintenance requirements.

DTS / DPF 9.5

Buildings utilise a combination (or thereof) of the following external materials and finishes:

- (a) masonry;
- (b) natural stone; and
- (c) pre-finished materials that minimise staining, discolouring or deterioration.

PO 9.6

Street facing building elevations designed to provide attractive, high quality and pedestrian friendly street frontages.

DTS / DPF 9.6

Building street frontages incorporate:

- (a) active uses such as shops or offices;
- (b) prominent entry areas for multi-storey buildings (where it is a common entry);
- (c) habitable rooms of dwellings; and
- (d) areas of communal public realm with public art or the like, where consistent with the Zone and/or sub zone provisions.

PO 9.7

Entrances to multi-storey buildings are safe, attractive, welcoming, functional and contribute to streetscape character.

DTS / DPF 9.7

Entrances to multi-storey buildings:

- (a) oriented towards the street;
- (b) clearly visible and easily identifiable from the street and vehicle parking areas;
- (c) designed to be prominent, accentuated and a welcoming feature if there are no active or occupied ground floor uses;
- (d) provide shelter, a sense of personal address and transitional space around the entry;

- (e) located as close as practicable to the lift and / or lobby access to minimise the need for long access corridors; and
- (f) avoid the creation of potential areas of entrapment.

PO 9.8

Building services, plant and mechanical equipment screened from view from the public realm.

DTS 9.8

None are applicable.

Landscaping

PO 10.1

Development facing a street provides a well landscaped area that contains a deep soil space to accommodate a tree of a species and size adequate to provide shade, contribute to tree canopy targets and soften the appearance of buildings.

DTS / DPF 10.1

Buildings provide a 4m by 4m deep soil space in front of the building to accommodate a medium to large tree, except where no building setback from front property boundaries is desired.

PO 10.2

Deep soil zones provided to retain existing vegetation or provide areas that can accommodate new deep root vegetation, including tall trees with large canopies to provide shade and soften the appearance of multi storey buildings.

DTS / DPF 10.2

Multi-storey development provides deep soil zones and incorporate trees at not less than the following rates, except in a location or zone where full site coverage is desired:

Site-area	Minimum-deep-soil-area	Minimum-dimension	Tree/-deep-soil-zones
<300m ²	10m ²	1.5m	1-small-tree/-10m ² -deep-soil
300-1500m ²	7%-site-area	3m	1-medium-tree/-30m ² -deep-soil
>1500m ²	7%-site-area	6m	1-large-or-medium-tree/-60m ² -deep-soil
Tree-size-and-site-area-definitions			
Small-tree	4-6m-mature-height-and-<4m-canopy-spread		
Medium-tree	6-12m-mature-height-and-4-8m-canopy-spread		
Large-tree	12m-mature-height-and->8m-canopy-spread		
Site-area	The-total-area-for-development-site, not-average-area-per-dwelling		

PO 10.3

Deep soil zones provided with access to natural light to assist in maintaining vegetation health.

DTS 10.3

None are applicable.

PO 10.4

Unless separated by a public road or reserve, development sites adjacent to any zone that has a primary purpose of accommodating low rise residential development incorporate a deep soil zone along the common boundary, to enable medium to large trees to be retained or established to assist in screening new buildings of 3 or more storeys in height.

DTS / DPF 10.4

Building elements of 3 or more storeys in height are set back at least 6m from a zone boundary in which a deep soil zone area is incorporated.

Environmental

PO 11.1

Development minimises detrimental micro-climatic impacts on adjacent land and buildings.

DTS 11.1

None are applicable.

PO 11.2

Development incorporates sustainable design techniques and features such as window orientation, eaves and shading structures, water harvesting, green walls, and roof designs that enable the provision of rain water tanks (where they are not provided elsewhere on site), green roofs and photovoltaic cells.

DTS 11.2

None are applicable.

PO 11.3

Development of 5 or more storeys, or 21m or more in height (as measured from natural ground level and excluding rooftop mounted mechanical plant and equipment), designed to minimise the impacts of wind through measures such as:

- (a) a podium at the base of a tall tower and aligned with the street to deflect wind away from the street;
- (b) substantial verandahs around a building to deflect downward travelling wind flows over pedestrian areas;
- (c) the placement of buildings and use of setbacks to deflect the wind at ground level; and / or
- (d) avoid tall shear facades that create windy conditions at street level.

DTS 11.3

None are applicable.

Site Facilities / Waste Storage

PO 12.1

Development provides dedicated area for on-site collection and sorting of recyclable materials and refuse, green organic waste and wash bay facilities for the ongoing maintenance of bins that is adequate in size considering the number and nature of the activities they will serve and the frequency of collection.

DTS 12.1

None are applicable.

PO 12.2

Communal waste storage and collection areas located, enclosed and designed to be screened from view from the public domain, open space and dwellings.

DTS 12.2

None are applicable.

PO 12.3

Communal waste storage and collection areas designed to be well ventilated and located away from habitable rooms.

DTS 12.3

None are applicable.

PO 12.4

Communal waste storage and collection areas designed to allow waste and recycling collection vehicles to enter and leave the site without reversing.

DTS 12.4

None are applicable.

PO 12.5

For mixed use developments, non-residential waste and recycling storage areas and access provide opportunities for on-site management of food waste through composting or other waste recovery as appropriate.

DTS 12.5

None are applicable.

Car Parking

PO 13.1

Multi-level vehicle parking structures designed to contribute to active street frontages and complement neighbouring buildings.

DTS/ DPF 13.1

Multi-level vehicle parking structures within buildings to:

- (a) provide land uses such as commercial, retail or other non-car parking uses along ground floor street frontages; and
- (b) incorporate facade treatments along major street frontages that are sufficiently enclosed and detailed to complement adjacent buildings.

PO 13.2

Multi-level vehicle parking structures within buildings complement the surrounding built form in terms of height, massing and scale.

DTS 13.2

None are applicable.

ALL RESIDENTIAL DEVELOPMENT

External Appearance

PO 14.1

Dwellings incorporate windows facing primary street frontages to encourage passive surveillance and make a positive contribution to the streetscape.

DTS/DPF 14.1

Each dwelling with a frontage to a public street includes at least one window with a total window area of at least 2m² facing the primary street, from a habitable room that has a minimum room dimension of 2.7m.

PO 14.2

Dwellings incorporate entry doors within street frontages to address the street and provide a legible entry point for visitors.

DTS/DPF 14.2

Dwellings with a frontage to a public street have the entry door facing the public street.

Outlook and Amenity

PO 15.1

Primary living rooms have an external outlook to provide a high standard of amenity for occupants.

DTS / DPF 15.1

Primary living rooms (other than kitchens) incorporate a window with an external outlook towards the street frontage or private open space.

PO 15.2

Bedrooms separated or shielded from active communal recreation areas, common access areas and vehicle parking areas and access ways to mitigate noise and artificial light intrusion.

DTS 15.2

None are applicable.

Ancillary Development

PO 16.1

Residential ancillary buildings and structures sited and designed to not detract from the streetscape or appearance of buildings on the site or neighbouring properties.

DTS / DPF 16.1

Residential ancillary buildings and structures:

- (a) are not being constructed, added to or altered so that any part is situated:
 - i. in front of any part of the building line of the dwelling to which it is ancillary; or
 - ii. within 900mm of a boundary of the allotment with a secondary street (if the land has boundaries on two or more roads);
- (b) in the case of a garage or carport, the garage or carport is setback at least 5.5m from the boundary of the primary street;
- (c) not exceeding 7m or 50% of the site frontage (whichever is the lesser) when facing a primary street or secondary street;
- (d) if situated on a boundary (not being a boundary with a primary street or secondary street), a length not exceeding 10m unless:
 - i. a longer wall or structure exists on the adjacent site and is situated on the same allotment boundary; and
 - ii. the proposed wall or structure will be built along the same length of boundary as the existing adjacent wall or structure to the same or lesser extent;
- (e) if situated on a boundary of the allotment (not being a boundary with a primary street or secondary street), all walls or structures on the boundary not exceeding 45% of the length of that boundary;
- (f) will not be located within 3m of any other wall along the same boundary unless on an adjacent site on that boundary there is an existing wall of a building that would be adjacent to or abut the proposed wall or structure;
- (g) have a wall height or post height not exceeding 3m above natural ground level;
- (h) have a roof height where no part of the roof is more than 5m above the natural ground level; and
- (i) if clad in sheet metal, is pre-colour treated or painted in a non-reflective colour.

PO 16.2

Ancillary buildings and structures do not impede on-site functional requirements such as private open space provision, car parking requirements or result in over-development of the site.

DTS / DPF 16.2

Ancillary buildings and structures do not result in:

- (a) less private open space than specified in Design in Urban Areas Table 1 – Outdoor Open Space;
- (b) less on-site car parking than specified in Transport, Access and Parking Table 1 - Off-street Car Parking Requirements; and
- (c) the total roofed floor area of all existing or proposed ancillary building(s) or structure(s) exceeding 60m².

PO 16.3

Fixed plant and equipment in the form of pumps and/or filtration systems for a swimming pool or spa positioned and/or housed to not cause unreasonable noise nuisance to adjacent sensitive receivers.

DTS/DPF 16.3

The pump and/or filtration system is ancillary to a dwelling erected on the same site and is:

- (a) enclosed in a solid acoustic structure that is located at least 5m from the nearest habitable room located on an adjoining allotment; or
- (b) located at least 12m from the nearest habitable room located on an adjoining allotment.

Flooding

PO 17.1

Residential accommodation sited, designed and constructed to prevent the entry of floodwaters where the entry of flood waters is likely to result in undue damage to or compromise ongoing activities within buildings.

DTS / DPF 17.1

Residential accommodation has a ground finished floor level 300mm above the top of the kerb level of the primary street.

RESIDENTIAL DEVELOPMENT - 3 BUILDING LEVELS OR LESS

External appearance

PO 18.1

Garaging designed to not detract from the streetscape or appearance of a dwelling.

DTS/DPF 18.1

Garages and carports facing a street:

- (a) do not exceed 7m in width or 50% of the sites frontage (whichever is less); and
- (b) are situated so that no part of the garage or carport will be in front of any part of the building line of the dwelling
- (c) are setback at least 5.5m from the boundary of the primary street; and
- (d) unless the dwelling has two storeys along the street frontage:
 - i. have single width car parking with a maximum garage door not exceeding 3.5m on sites with a frontage of 12m; or less
 - ii. have a garage door not exceeding 50% of the site frontage or 7m (whichever is less) on sites with a frontage greater than 12m.

PO 18.2

Dwelling facades make a positive contribution to streetscapes and common areas by providing variation of light and shadow and creating a sense of depth.

DTS/DPF 18.2

Each dwelling includes at least 3 of the following design features within each façade facing a public road or common driveway:

- (a) a minimum of 30% of the façade is setback an additional 300mm from the primary building line;
- (b) a porch or portico that projects at least 1m from the building façade that is open on at least 2 sides;
- (c) a balcony that projects from the building façade;
- (d) a verandah that projects at least 1m from the building façade;
- (e) eaves surrounding the dwelling of a minimum 450mm width;
- (f) a minimum 30% of the upper level projects forward from the lower level primary building line.

PO 18.3

The apparent mass of larger buildings is reduced when viewed from adjoining allotments or public streets.

DTS/DPF 18.3

Buildings of 2 or more building levels and a length exceeding 20m adjacent a secondary street or side boundary incorporate a step back of the building façade of more than 300mm for a minimum length of 1m, at least every 10m.

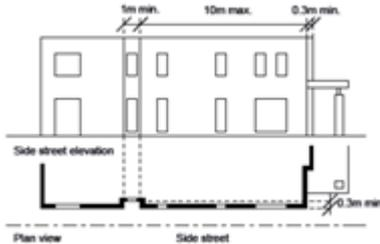

Overlooking / Visual Privacy

PO 19.1

Development mitigates direct overlooking of habitable rooms and private open spaces of dwellings.

DTS / DPF 19.1

Upper level windows facing side or rear boundaries shared with an allotment put to residential use:

- are permanently obscured to a height of 1.5m above finished floor level that is fixed or not capable of being opened more than 200mm;
- have sill heights greater than or equal to 1.5m above finished floor level; or
- incorporate screening to a height of 1.5m above finished floor level; and
- the building will not have a balcony or terrace on an upper building level, other than where the longest side of that balcony or terrace will face a road (including any road reserve), or reserve (including any land held as open space), and is at least 15m from the private open space of any other dwelling.

Private Open Space

PO 20.1

Dwellings provided with suitable sized areas of usable private open space to meet the needs of occupants.

DTS / DPF 20.1

Private open space provided in accordance with Design in Urban Areas Table 1 - Outdoor Open Space.

PO 20.2

Private open space positioned to provide convenient access from internal living areas.

DTS / DPF 20.2

Private open space is directly accessible from a habitable room, other than a bedroom or study.

PO 20.3

Private open space is positioned and designed to:

- provide useable outdoor space that suits the needs of occupants;
- take advantage of desirable orientation and vistas;
- animate the street frontage by encouraging activity between buildings and public streets;
- adequately define public and private space when located forward of the building; and
- prolong activity along street frontages by protecting against inclement weather.

DTS / DPF 20.3

A portion of the private open space specified in DTS 20.1 can be provided forward of the primary building line where:

- (a) the area is fenced to a maximum height of 1.8m;
- (b) the area incorporates a verandah with a minimum dimension of 1.5m
- (c) an area is provided behind the primary building line that has the minimum dimensions identified in DTS 20.1;

Landscaping

PO 21.1

Soft landscaping incorporated into development to:

- (a) minimise heat absorption and reflection;
- (b) contribute shade and shelter;
- (c) provide for stormwater infiltration and biodiversity; and
- (d) enhance the appearance of land and streetscapes.

DTS / DPF 21.1

Residential development incorporates areas for soft landscaping with a minimum dimension of 0.5 metres provided in accordance with the following:

(a)

Dwelling-site-area-(or-in-the-case-of-residential-flat-or-group-average-site-area)-(square-metres)⌘	%-of-site-⌘
<200⌘	15%⌘
201--450⌘	20%⌘
>450⌘	25%⌘

; and

- (b) 25% of any land between the road boundary and the primary building line is provided for soft landscaping with a minimum dimension of 0.5 metres.

PO 21.2

Tree planting provided to:

- (a) contribute shade and shelter;
- (b) improve outlook for occupants of buildings;
- (c) reduce the apparent mass of buildings;
- (d) contribute to biodiversity;
- (e) mitigate urban heat; and
- (f) improve the amenity and character of streetscapes and contribute to attractive vistas.

DTS / DPF 21.2

Tree planting is provided in accordance with the following tables:

(a)

Allotment-size	Tree-size* and-number-required-per-dwelling
<450m ²	1 small tree per dwelling
450-800m ²	1 medium tree
800m ² +	1 large tree

*refer Table DTS 21.2 Tree Size

Table-DTS-21.2-Tree-Size			
Tree-Size	Mature-Height	Mature-spread	Min-soil-area
Small	4-6m	2-4m	10m ² and min dimension of 1.5m
Medium	6-12m	4-8m	30m ² and min dimension of 2m
Large	>12m	>8m	60m ² and min dimension of 4m

Table DTS 21.2 Tree Size

(b) The following discounts apply where existing trees are retained on the subject land that are not a species identified in Regulation 3F(4)(b):

Retained-tree-height	Retained-tree-spread	Retained-soil-area-within-development-site	Discount-applied
4-6m	<4m	10m ² and min dimension of 1.5m	2 small
6-12m	4-8m	30m ² and min dimension of 3m	2 medium
>12m	>8m	60m ² and min dimension of 6m	2 large

(c) Trees can be replaced with smaller trees in accordance with the following rates:

Tree-size*	Equivalent-planting
Medium tree	2 small trees
Large tree	4 small trees or 2 medium trees

*refer Table DTS 21.2 Tree Size

Water Sensitive Design

PO 22.1

Residential development designed to capture and re-use stormwater to:

(a) maximise conservation of water resources;

- (b) manage peak stormwater runoff flows and volume to ensure the carrying capacities of downstream systems are not overloaded; and
- (c) manage stormwater runoff quality.

DTS / DPF 22.1

Residential development in the form of:

- (a) detached, semi-detached or row dwellings include a retention rainwater tank storage:
 - i. connected to at least 80% of the roof area of the dwelling (row dwelling), or at least 60% of the roof area of the dwelling (detached and semi-detached dwellings);
 - ii. connected to all toilets and either the laundry cold water outlets or hot water service;
 - iii. that has a minimum total capacity in accordance with Table 1, and
 - iv. the roof is at least 80% of the impervious area; or

Table 1: Retention Rainwater Tank

Allotment size (m ²)	Minimum site % perviousness	Minimum rainwater tank volume	Additional site permeability discount opportunity	
			Site % perviousness	Minimum rainwater tank volume (L)
<200	15%	2,000		
201-400	20%	3,000	30%	2,000
400-500	25%	5,000	35%	3,000

- (a) hammerhead dwellings have driveways and pathways constructed of a minimum of 50% permeable or porous material and include a retention rainwater tank storage:
 - i. connected to at least 60% of the roof area of the dwelling;
 - ii. connected to all toilets and either the laundry cold water outlets or hot water service; and
 - iii. that has a minimum total capacity in accordance with Table 2.

Table 2: Retention Rainwater Tank Option

Allotment size (m ²)	Site % perviousness	Rainwater tank volume (L)
<200	15%	2,000
201-400	20%	3,000
401-500	25%	5,000

PO 22.2

Development creating 5-19 dwellings includes stormwater management systems that minimise the discharge of sediment, suspended solids, organic matter, nutrients, bacteria, litter and other contaminants to the stormwater system, watercourses or other water bodies.

DTS 22.2

Development creating 5-19 dwellings is accompanied by an approved Stormwater Management Plan that achieves the following stormwater runoff outcomes:

- (a) 80 per cent reduction in average annual total suspended solids;
- (b) 60 per cent reduction in average annual total phosphorus; and
- (c) 45 per cent reduction in average annual total nitrogen.

PO 22.3

Development creating 5-19 dwellings includes a stormwater management system designed to mitigate peak flows and manage the rate and duration of stormwater discharges from the site to ensure the carrying capacities of downstream systems are not overloaded.

DTS 22.3

Development creating 5-19 dwellings

- (a) maintains:
 - i. a pre-development peak flow rate from the site based upon a 0.35 runoff coefficient for the 5-year ARI (18.1% AEP) 30 minute storm; and
 - ii. the stormwater runoff time to peak to match that of the pre-development condition; or
- (b) capture and retain the difference in pre-development runoff volume (based upon a 0.35 runoff coefficient) vs post development runoff volume from the site for a 5-year ARI (18.1% AEP) 30 minute storm; and
- (c) manage site generated stormwater runoff up to and including the 100 –year ARI flood event (1% AEP) to avoid flooding of buildings.

Car parking, access and manoeuvrability

PO 23.1

Covered car parking spaces are of dimensions to be functional, accessible and convenient.

DTS / DPF 23.1

Covered car parking spaces:

- (a) where enclosed by fencing or walls, have:
 - i. a minimum internal width of 3.2m and length of 6.0m for a single space;
 - ii. a minimum internal width of 6.0m and length of 6.0m for a double space (side by side); and
 - iii. a minimum internal width of 3.2m and length of 11m for a double space (tandem); or
- (b) where not enclosed by fencing, walls or garage doors, have:
 - i. a minimum width of 3.0m and minimum length of 5.5m for a single space;
 - ii. a minimum width of 5.2m and minimum length of 5.5m for a double (side by side) space; and
 - iii. a minimum width of 3.0m and minimum length of 10.4m for a double (tandem) space.

PO 23.2

Uncovered car parking space are of dimensions to be functional, accessible and convenient.

DTS / DPF 23.2

Uncovered car parking spaces have a minimum width of 2.4m and a minimum length of 5.5m.

PO 23.3

Driveways and access points located and designed to facilitate safe access and egress while maximising land available for street tree planting, landscaped street frontages and on-street parking.

DTS / DPF 23.3

Driveways and access points:

- (a) for sites with a frontage to a public road of 12m or less, have a maximum width of 3.2m measured at the property boundary and are the only access point provided on the site; or
- (b) for sites with a frontage to a public road greater than 12m:
 - i. have a maximum width of 6m measured at the property and are the only access point provided on the site; or
 - ii. have a maximum width of 3.2 metres measured at the property boundary and no more than two access points are provided on site.

PO 23.4

Vehicle access is safe, convenient, minimises interruption to the operation of public roads and does not interfere with street infrastructure or street trees.

DTS / DPF 23.4

Vehicle access to designated car parking spaces:

- (a) is provided via a lawfully existing or authorised driveway or access point or an access point for which consent has been granted as part of an application for the division of land
- (b) where newly proposed, is setback:
 - (a) 500mm or more from any street furniture, street pole, infrastructure services pit, or other stormwater or utility infrastructure unless consent is provided from the asset owner;
 - (b) 2m or more from a street tree unless consent is provided from the tree owner;
 - (c) 6m or more from the tangent point of an intersection of 2 or more roads or a pedestrian-actuated crossing.

PO 23.5

Driveways are designed to enable safe and convenient vehicle movements from the public road to on-site parking spaces.

DTS/ DPF 23.5

Driveways are designed and sited so that:

- (a) the gradient from the place of access on the boundary of the allotment to the finished floor level at the front of the garage or carport when work is completed is not steeper than 1:4 on average; and
- (b) the centre of the driveway at the public road boundary is no more than 25 degree deviation from the centre of the front of the covered car parking space for which it provides vehicle access.

PO 23.6

Driveways and access points are designed and distributed to optimise the provision of on-street visitor parking (where on-street parking is appropriate).

DTS / DPF 23.6

Where on-street parking is available directly adjacent the site, parking is retained in accordance with the following requirements:

- (a) 1 on-street car park per 3 proposed dwellings (rounded up to the nearest whole number); and
- (b) minimum car park length of 6m.

Waste storage

PO 24.1

Provision is made for the convenient storage of waste bins in a location screened from public view.

DTS / DPF 24.1

Dwellings are provided with:

- (a) an area of 3m² or more for the storage of waste (separate from any designated car parking spaces or private open space) is provided behind the building line; and
- (b) a continuous unobstructed path of travel with a minimum width of 800mm between the waste bin storage area and the street.

Design of Transportable Dwellings

PO 25.1

The sub-floor space beneath transportable buildings enclosed to give the appearance of a permanent structure.

DTS 25.1

None are applicable.

RESIDENTIAL DEVELOPMENT - 4 OR MORE BUILDING LEVELS (INCLUDING SERVICED APARTMENTS)

Outlook and Visual Privacy

PO 26.1

Ground level dwellings have a satisfactory short range visual outlook to public, communal or private open space.

DTS / DPF 26.1

Buildings:

- (a) provide a habitable room at ground or first level with a window facing toward the street; and
- (b) limit the height / extent of solid walls or fences facing the street to 1.2m high above the footpath level or, where higher, to 50% of the site frontage.

PO 26.2

The visual privacy of ground level dwellings within multi-level buildings is protected.

DTS / DPF 26.2

The finished floor level of ground level dwellings in multi-storey developments is raised by up to 1.2m.

Private Open Space

PO 27.1

Dwellings provided with suitable sized areas of usable private open space to meet the needs of occupants.

DTS / DPF 27.1

Private open space provided in accordance with Design in Urban Areas Table 1 - Outdoor Open Space.

Apartment Amenity

PO 28.1

Residential accommodation within multi-level buildings have habitable rooms, windows and balconies designed and positioned to be separated from those of other dwellings and accommodation to provide visual and acoustic privacy and allow for natural ventilation and the infiltration of daylight into interior and outdoor spaces.

DTS / DPF 28.1

Habitable rooms and balconies of independent dwellings and accommodation are separated by at least 6m from one another where there is a direct 'line of sight' between them and 3m or more from a side or rear property boundary.

PO 28.2

Balconies are designed, positioned and integrated into the overall architectural form and detail of the development to:

- (a) respond to daylight, wind, and acoustic conditions to maximise comfort and provide visual privacy; and
- (b) allow views and casual surveillance of the street while providing for safety and visual privacy of nearby living spaces and private outdoor areas.

DTS / DPF 28.2

Balconies utilise a combination (or thereof) of the following design elements:

- (a) sun screens;
- (b) pergolas;
- (c) louvres;
- (d) green facades; or

(e) openable walls.

PO 28.3

Balconies are of sufficient size and depth to accommodate outdoor seating and promote indoor / outdoor living.

DTS / DPF 28.3

Balconies open directly from a habitable room and incorporate:

- (a) a minimum dimension of 2m or more and are well proportioned to accommodate a table and 2 chairs; or
- (b) a minimum dimension of 2.4m and are well proportioned to accommodate a table and 4 chairs.

PO 28.4

Dwellings are provided with sufficient space for storage to meet likely occupant needs.

DTS / DPF 28.4

Dwellings (not including student accommodation or serviced apartments) are provided with storage at the following rates:

- (a) studio: 6m³ or more;
- (b) 1 bedroom dwelling / apartment: 8m³ or more;
- (c) bedroom dwelling / apartment: 10m³ or more; and
- (d) 3+ bedroom dwelling / apartment: 12m³; and
- (e) 50% or more of the storage volume is provided within the dwelling.

PO 28.5

Universal design features are incorporated to provide options for people living with disabilities or limited mobility and / or to facilitate ageing in place.

DTS 28.5

None are applicable.

Apartment Configuration

PO 29.1

Buildings containing in excess of 10 dwellings provide a variety of dwelling sizes and a range in the number of bedrooms per dwelling to contribute to housing diversity.

DTS / DPF 29.1

Buildings containing in excess of 10 dwellings provide at least one of each of the following:

- (a) studio (where there is no separate bedroom);
- (b) 1 bedroom dwelling / apartment with a floor area of at least 50m²;
- (c) 2 bedroom dwelling / apartment with a floor area of at least 65m²; and
- (d) 3+ bedroom dwelling / apartment with a floor area of at least 80m², and any dwelling over 3 bedrooms provides an additional 15m² for every additional bedroom.

PO 29.2

Dwellings located on the ground floor of multi-level buildings with 3 or more bedrooms have the windows of their habitable rooms overlooking internal courtyard space or other public space, where possible.

DTS 29.2

None are applicable.

Common Areas

PO 30.1

The size of lifts, lobbies and corridors is sufficient to accommodate movement of bicycles, strollers, mobility aids and visitor waiting areas.

DTS / DPF 30.1

Common corridor or circulation areas:

- (a) have a minimum ceiling height of 2.7m;
- (b) provide access to no more than 8 dwellings; and
- (c) incorporate a wider section of apartment entries where the corridors exceed 12m in length from a core.

GROUP DWELLINGS, RESIDENTIAL FLAT BUILDINGS AND BATTLE-AXE DEVELOPMENT

Amenity

PO 31.1

Dwellings are of a suitable size to provide high standard of amenity for occupants.

DTS / DPF 31.1

Dwellings have a minimum internal floor area in accordance with the following table:

Bedrooms	Minimum-internal-floor-area
Studio (where there is no separate bedroom)	35m ²
1-bed	50m ²
2-bed	65m ²
3+ bed	80m ² , and any dwelling over 3 bedrooms provides an additional 15m ² for every additional bedroom

PO 31.2

The orientation and siting of buildings minimises impacts on the amenity, outlook and privacy of occupants and neighbours.

DTS / DPF 31.1

None are applicable.

PO 31.3

Development maximises the number of dwellings that face public open space and public streets and limits dwellings oriented towards neighbouring properties.

DTS 31.3

None are applicable.

Communal Open Space

PO 32.1

Communal open space provided where private open space provision is inadequate to meet the needs of occupants or where the nature of the development is such that private open space is not ordinarily provided.

DTS 32.1

None are applicable.

Car parking, access and manoeuvrability

PO 33.1

Driveways and access points are designed and distributed to optimise the provision of on-street visitor parking (where on-street parking is appropriate).

DTS / DPF 33.1

Where on-street parking is available directly adjacent the site, parking is retained in accordance with the following requirements:

- (a) 1 on-street car park per 3 proposed dwellings (rounded up to the nearest whole number); and
- (b) minimum car park length of 6m.

PO 33.2

The number of vehicular access points onto public roads is minimised to reduce interruption of the footpath and positively contribute to public safety and walkability.

DTS / DPF 33.2

Access to group dwellings or dwellings within a residential flat building provided via a single common driveway.

PO 33.3

Driveways, access points, access tracks and parking areas are designed and constructed to allow adequate movement and manoeuvrability of the types of vehicles that are reasonably anticipated.

DTS / DPF 33.3

Battle-axe driveways and driveways that service more than one dwelling satisfy the following:

- (a) a width of 3m or more;
- (b) for driveways servicing three or more dwellings which exceed 30m in length, incorporate a least one vehicle passing point with a width of 5m or more and a length of 6m or more, and an additional passing point at least every 30m thereafter;
- (c) locate the passing point in (b) within 12m of the primary street boundary; and
- (d) a width of 5m or more for at least the first 6m from the primary street boundary where located on an arterial road.

PO 33.4

Driveways that service more than one dwelling are designed to allow passenger vehicles to enter and exit the site in a safe and convenient manner.

DTS / DPF 33.4

Driveways providing access to more than one dwelling allow a B85 passenger vehicle to enter and exit all dedicated car parks and garages in a forward direction without requiring more than a 2-point-turn manoeuvre.

PO 33.5

Dwellings are adequately separated from common driveways and manoeuvring areas.

DTS/DPF 33.5

Dwellings are at least 1.5m from any vehicle movement path required to achieve DTS 34.3.

Landscaping

PO 34.1

Landscaping is provided between dwellings and common driveways to improve the outlook for occupants and improve the appearance of common areas.

DTS/ DPF 34.1

Other than where located directly in front of a garage or directly adjacent a building entry door, soft landscaping with a minimum dimension of 1m is provided between a dwelling and common driveway.

PO 34.2

Landscaping is provided that improves the appearance of common driveways.

DTS / DPF 34.2

Where a common driveway is located directly adjacent the side or rear boundary of the site, soft landscaping with a minimum dimension of 1m is provided between the driveway and site boundary (excluding along the perimeter of a passing point required in DTS 34.3).

Site Facilities / Waste Storage

PO 35.1

Provision is made for suitable mailbox facilities close to the major pedestrian entry to the site or conveniently located considering the nature of accommodation and mobility of occupants.

DTS 35.1

None are applicable.

PO 35.2

Provision is made for suitable external clothes drying facilities.

DTS 35.2

None are applicable.

PO 35.3

Provision is made for suitable household waste and recyclable material storage facilities conveniently located away, or screened, from public view.

DTS 35.3

None are applicable.

PO 35.4

Waste and recyclable material storage areas are located away from dwellings.

DTS / DPF 35.4

Dedicated waste and recyclable material storage areas are located at least 3m from any habitable room window.

PO 35.5

Provision is made for on-site waste collection where 10 or more bins are to be collected at any one time.

DTS 35.5

None are applicable.

SUPPORTED ACCOMMODATION, HOUSING FOR AGED PERSONS, AND PEOPLE WITH DISABILITIES

Siting and Configuration

PO 36.1

Supported accommodation and housing for aged persons and people with disabilities located where on-site movement of residents is not unduly restricted by the slope of the land.

DTS 36.1

None are applicable.

Movement and Access

PO 37.1

Development designed to support safe and convenient access and movement for residents by providing:

- (a) ground-level access or lifted access to all units;
- (b) level entry porches, ramps, paths, driveways, passenger loading areas and areas adjacent to footpaths that allow for the passing of wheelchairs and resting places;
- (c) car parks with gradients no steeper than 1-in-40, and of sufficient area to provide for wheelchair manoeuvrability; and
- (d) kerb ramps at pedestrian crossing points.

DTS 37.1

None are applicable.

Communal Open Space

PO 38.1

Development designed to provide attractive, convenient and comfortable indoor and outdoor communal areas to be used by residents and visitors alike.

DTS 38.1

None are applicable.

PO 38.2

Communal open space provided where private open space provision is inadequate to meet the needs of occupants or where the nature of the development is such that private open space is not ordinarily provided (such as supported accommodation).

DTS 38.2

None are applicable.

Site Facilities / Waste Storage

PO 39.1

Development designed to provide storage areas for personal items and specialised equipment such as small electric powered vehicles, including facilities for the recharging of small electric powered vehicles.

DTS 39.1

None are applicable.

PO 39.2

Provision is made for suitable mailbox facilities close to the major pedestrian entry to the site or conveniently located considering the nature of accommodation and mobility of occupants.

DTS 39.2

None are applicable.

PO 39.3

Provision is made for suitable external clothes drying facilities.

DTS 39.3

None are applicable.

PO 39.4

Provision is made for suitable household waste and recyclable material storage facilities conveniently located away, or screened, from view.

DTS 39.4

None are applicable.

PO 39.5

Waste and recyclable material storage areas are located away from dwellings.

DTS / DPF 39.5

Dedicated waste and recyclable material storage areas are located at least 3m from any habitable room window.

PO 39.6

Provision is made for on-site waste collection where 10 or more bins are to be collected at any one time.

DTS 39.6

None are applicable.

PO 39.7

Services including gas and water meters conveniently located and screened from public view.

DTS 39.7

None are applicable.

STUDENT ACCOMMODATION**PO 40.1**

Student accommodation is designed to provide safe, secure, attractive, convenient and comfortable living conditions for residents, including an internal layout and facilities that are designed to provide sufficient space and amenity for the requirements of student life and promote social interaction. DTS / DPF 41.1

Student accommodation provides:

- (a) a range of living options that meet a variety of accommodation needs, such as one bedroom, two bedroom and disability access units;
- (b) common or shared facilities to enable a more efficient use of space, including:
 - i. shared cooking, laundry and external drying facilities;
 - ii. internal and external communal and private open space provided in accordance with Design in Urban Areas Table 1 - Outdoor Open Space;
 - iii. common storage facilities at the rate of 8 cubic metres for every 2 dwellings or students;
 - iv. common on-site parking to meet anticipated demand in accordance with Transport, Access and Parking Table 1 - Off-street Car Parking Requirements ; and
 - v. secure and sheltered bicycle parking at the rate of one space for every 2 students.

PO 40.2

Student accommodation designed to provide easy adaptation of the building to accommodate an alternative use of the building in the event it is no longer required for student housing.

DTS 40.2

None are applicable.

ALL NON-RESIDENTIAL DEVELOPMENT

Water Sensitive Design

PO 41.1

Development likely to result in risk of export of sediment, suspended solids, organic matter, nutrients, oil and grease include stormwater management systems designed to minimise pollutants entering stormwater.

DTS/DPF 41.1

Development includes stormwater management systems designed to achieve the following gross pollutant outcomes:

- (a) 80 per cent reduction in average annual total suspended solids;
- (b) 60 per cent reduction in average annual total phosphorus;
- (c) 45 per cent reduction in average annual total nitrogen;
- (d) 90 per cent reduction of litter/gross pollutants compared to untreated stormwater runoff; and
- (e) no visible oils/grease for flows up to the 1-in-3 month average return interval flood peak flow.

PO 41.2

Water discharged from a development site to be of a physical, chemical and biological condition equivalent to or better than its pre-developed state.

DTS 41.2

None are applicable.

PO 41.3

Development includes stormwater management systems to mitigate peak flows and manage the rate and duration of stormwater discharges from the site to ensure the carrying capacities of downstream systems are not overloaded.

DTS / DPF 41.3

Development includes stormwater management systems that:

- (a) maintain a pre-development peak flow rate from the site, based upon a 0.35 runoff coefficient for the 20-year ARI (5% AEP) 30 minute storm, unless a lower performance measure is specified in an approved catchment based Stormwater Management Plan;
- (b) maintains the stormwater runoff time to peak to match that of the pre-development; and
- (c) manages up to and including the 100-year ARI flood event (1% AEP) to avoid flooding of buildings.

Wash-down and Waste Loading and Unloading

PO 42.1

Areas for activities including loading and unloading, storage of waste refuse bins in commercial and industrial development or wash-down areas used for the cleaning of vehicles, plant or equipment that are:

- (a) designed to contain all wastewater likely to pollute stormwater within a bunded and roofed area to exclude the entry of external surface stormwater run-off;
- (b) paved with an impervious material to facilitate wastewater collection;
- (c) of sufficient size to prevent 'splash-out' or 'over-spray' of wastewater from the wash-down area; and
- (d) designed to drain wastewater to either:
 - i. a treatment device such as a sediment trap and coalescing plate oil separator with subsequent disposal to a sewer, private or Community Wastewater Management Scheme; or

- ii. a holding tank and its subsequent removal off-site on a regular basis.

DTS 42.1

None are applicable.

Table 1 - Outdoor Open Space

Dwelling Type	Dwelling / Site Configuration	Minimum Rate
Detached dwelling Semi-detached dwelling Row dwelling Group dwelling	Site area >1,000m ²	Total area: 20% of total site area Adjacent to habitable room: 10% total site area / minimum dimension 4m.
	Site area 500m ² – 1,000m ²	Total area: 80m ² Adjacent to habitable room: 24m ² / minimum dimension 4m.
	Site area 300m ² - 500m ²	Total area: 60m ² Adjacent to habitable room: 16m ² / minimum dimension 4m.
	Site area <300m ²	Total area: 24m ² Adjacent to habitable room: 16m ² / minimum dimension 3m
Cabin or caravan (permanently fixed to the ground) in a Residential Park Zone or Caravan and Tourist Park Zone		Total area: 16m ² , which may be used as second car parking space, provided on each site intended for residential occupation.
Apartments	Dwellings at ground level:	
	- All types	15m ² / minimum dimension 3m
	Dwellings located above ground level:	
	- Studio	4m ² / minimum dimension 1.8m
	- One bedroom dwelling	8m ² / minimum dimension 2.1m
	- Two bedroom dwelling	11m ² / minimum dimension 2.4m
- Three + bedroom dwelling	15 m ² / minimum dimension 2.6m	

Design in Rural Areas

Assessment Provisions (AP)

Desired Outcome (DO)

DO 1

Development that is:

- (a) contextual – by considering, recognising and carefully responding to its natural surroundings and positively contributing to the character of the immediate area;
- (b) durable – fit for purpose, adaptable and long lasting;
- (c) inclusive – by integrating landscape design to optimise pedestrian and cyclist usability, privacy and equitable access, and also promote the provision of quality spaces integrated with the public realm that can be used for access and recreation and help optimise security and safety both internally and within the public realm, for occupants and visitors alike; and
- (d) sustainable – by integrating sustainable techniques into the design and siting of development and landscaping to improve community health, urban heat, water management, environmental performance, biodiversity and local amenity and to minimise energy consumption.

Performance Outcomes and Deemed to Satisfy / Designated Performance Outcome Criteria

ALL DEVELOPMENT

External Appearance

PO 1.1

Buildings that reinforce corners through changes in setback, articulation, materials, colour and massing (including height, width, bulk, roof form and slope).

DTS 1.1

None are applicable.

PO 1.2

Where zero or minor setbacks are desirable, development provides shelter over footpaths to positively contribute to the walkability and comfort of the public realm.

DTS 1.2

None are applicable.

PO 1.3

Buildings (other than ancillary buildings, group dwellings or buildings on a battle-axe allotment) designed so the main façade faces the primary street frontage of the land on which they are situated.

DTS 1.3

None are applicable.

PO 1.4

Plant, exhaust and intake vents and other technical equipment integrated into the building design to minimise visibility from the public realm and negative impacts on residential amenity by:

- (a) positioning plant and equipment discretely, in unobtrusive locations as viewed from public roads and spaces;
- (b) screening rooftop plant and equipment from view; and
- (c) when located on the roof of non-residential development, locating the plant and equipment as far as practicable from adjacent sensitive land uses.

DTS / DPF 1.4

Development does not incorporate any structures that protrude beyond the roofline.

PO 1.5

The negative visual impact of outdoor storage, waste management, loading and service areas is minimised by integrating them into the building design and screening them from public view (such as fencing, landscaping and built form) taking into account the form of development contemplated in the relevant zone.

DTS 1.5

None are applicable.

Safety

PO 2.1

Development maximises opportunities for passive surveillance of the public realm by providing clear lines of sight, appropriate lighting and the use of visually permeable screening wherever practicable.

DTS 2.1

None are applicable.

PO 2.2

Development designed to differentiate public, communal and private areas.

DTS 2.2

None are applicable.

PO 2.3

Buildings designed with safe, perceptible and direct access from public street frontages and vehicle parking areas.

DTS 2.3

None are applicable.

PO 2.4

Development at street level designed to maximise opportunities for passive surveillance of adjacent public realm.

DTS 2.4

None are applicable.

PO 2.5

Common areas and entry points of buildings (such as the foyer areas of residential buildings), and non-residential land uses at street level, maximise passive surveillance from the public realm to the inside of the building at night.

DTS 2.5

None are applicable.

Landscaping

PO 3.1

Landscaped (including trees), permeable open spaces incorporated to:

- (a) minimise heat absorption and reflection;
- (b) maximise shade and shelter;

- (c) maximise stormwater infiltration; and
- (d) enhance the appearance of land and streetscapes.

DTS 3.1

None are applicable.

Environmental Performance

PO 4.1

Buildings sited, oriented and designed to maximise natural sunlight access and ventilation to main activity areas, habitable rooms, common areas and open spaces.

DTS 4.1

None are applicable.

PO 4.2

Buildings sited and designed to maximise passive environmental performance and minimise energy consumption and reliance on mechanical systems, such as heating and cooling.

DTS 4.2

None are applicable.

PO 4.3

Buildings incorporate climate responsive techniques and features such as building and window orientation, use of eaves, verandahs and shading structures, water harvesting, at ground landscaping, green walls, green roofs and photovoltaic cells.

DTS 4.3

None are applicable.

Water Sensitive Design

PO 5.1

Development sited and designed to maintain natural hydrological systems without negatively impacting:

- (a) the quantity and quality of surface and groundwater;
- (b) the depth and directional flow of surface and groundwater; or
- (c) the quality and function of natural springs.

DTS 5.1

None are applicable.

On-site Waste Treatment Systems

PO 6.1

Dedicated on-site effluent disposal areas that do not include any areas to be used for, or could be reasonably foreseen to be used for, private open space, driveways or car parking.

DTS / DPF 6.1

Effluent disposal drainage areas do not:

- (a) encroach within an area used as private open space or would result in less private open space than that specified in Design in Rural Areas Table 1 - Private Open Space;
- (b) use an area also used as a driveway; and
- (c) encroach within an area used for on-site car parking or would result in less on-site car parking than that specified in Transport, Access and Parking Table 1 - Off-Street Car Parking Requirements.

Car parking appearance

PO 7.1

Development facing the street designed to minimise the negative impacts of any semi-basement and under-croft car parking on the street scape.

DTS / DPF 7.1

The protrusion of undercroft car parks to not exceed 1.2m above finished ground level and screened through appropriate plantings, except in a location or zone where a continuous ground floor façade aligned with the front property boundary is desired.

PO 7.2

Vehicle parking areas appropriately located, designed and constructed to minimise impacts on adjacent sensitive receivers through measures such as ensuring they are attractively developed and landscaped, screen fenced, and the like.

DTS 7.2

None are applicable.

PO 7.3

Pedestrian connections that are safe, legible, direct and accessible are provided between parking areas and the development.

DTS 7.3

None are applicable.

PO 7.4

Street level vehicle parking areas that are open to the sky are landscaped to provide shade and reduce solar heat absorption and reflection.

DTS / DPF 7.4

Vehicle parking areas that are open to the sky and comprise 10 or more car parking spaces, include a shade tree with a mature canopy of 4m diameter spaced for each 10 car parking spaces provided and a landscaped strip on any road frontage of a minimum dimension of 1m.

PO 7.5

Vehicle parking areas are landscaped along public frontages, allotment boundaries and between double rows of parking spaces.

DTS / DPF 7.5

Vehicle parking areas comprising 10 or more car parking spaces contain a vegetated landscaped strip of a minimum dimension of:

- (a) 1m along all public road frontages and allotment boundaries; and
- (b) 0.6m between double rows of car parking spaces.

PO 7.6

Vehicle parking areas and associated driveways are landscaped to shade and positively contribute to amenity.

DTS 7.6

None are applicable.

PO 7.7

Vehicle parking areas and accessways incorporate integrated stormwater management techniques such as permeable or porous surfaces, infiltration systems, drainage swales or rain gardens that integrate with landscaping requirements.

DTS 7.7

None are applicable.

Earthworks

PO 8.1

Development, including any associated driveways and access tracks, minimise the need for earthworks to limit disturbance to natural topography.

DTS / DPF 8.1

Development does not involve either:

- (a) excavation exceeding a vertical height of 1m;
- (b) filling exceeding a vertical height of 1m; or
- (c) a total combined excavation and filling vertical height of 2m or more.

Fences and walls

PO 9.1

Fences, walls and retaining walls alongside and rear boundaries of sufficient height to maintain privacy and security without unreasonably impacting visual amenity and adjoining land's access to sunlight.

DTS 9.1

None are applicable.

PO 9.2

Landscaping incorporated on the low side of retaining walls that are visible from public roads and public open space to minimise visual impacts.

DTS / DPF 9.2

A vegetated landscaped strip 500mm deep or more is provided against the low side of a retaining wall.

ALL RESIDENTIAL DEVELOPMENT

External appearance

PO 10.1

Dwellings incorporate windows along primary street frontages to encourage passive surveillance and make a positive contribution to the streetscape.

DTS/DPF 10.1

Each dwelling with a frontage to a public street includes at least one window (or windows) with a total window area of at least 2m² facing the primary street, from a habitable room that has minimum room dimension of 2.7m.

PO 10.2

Dwellings incorporate entry doors within street frontages to address the street and provide a legible entry point for visitors.

DTS/DPF 10.2

Dwellings with a frontage to a public street has the entry door facing the public street.

Outlook and amenity

PO 11.1

Primary living rooms have an external outlook to provide a high standard of amenity for occupants.

DTS / DPF 11.1

Primary living rooms (other than kitchens) incorporate a window with an external outlook towards the street frontage or private open space.

PO 11.2

Bedrooms separated or shielded from active communal recreation areas, common access areas and vehicle parking areas and access ways to mitigate noise and artificial light intrusion.

DTS 11.2

None are applicable.

Ancillary Development

PO 12.1

Residential ancillary buildings and structures sited and designed to not detract from the streetscape or appearance of buildings on the site or neighbouring properties.

DTS / DPF 12.1

Residential ancillary buildings and structures:

- (a) are not being constructed, added to or altered so that any part is situation:
 - i. in front of any part of the building line of the dwelling to
 - ii. within 900mm of a boundary of the allotment with a secondary street (if the land has boundaries on two or more roads)
- (b) in the case of a garage or carport, the garage or carport is setback at least 5.5m from the boundary of the primary street;
- (c) not exceeding 7m or 50% of the site frontage (whichever is the lesser) when facing a primary street or secondary street;
- (d) if situated on a boundary (not being a boundary with a primary street or secondary street), a length not exceeding 10m unless:
 - i. a longer wall or structure exists on the adjacent site and is situated on the same allotment boundary; and
 - ii. the proposed wall or structure will be built along the same length of boundary as the existing adjacent wall or structure to the same or lesser extent
- (e) if situated on a boundary of the allotment (not being a boundary with a primary street or secondary street), all walls or structures on the boundary not exceeding 45% of the length of that boundary;
- (f) will not be located within 3m of any other wall along the same boundary unless on an adjacent site on that boundary there is an existing wall of a building that would be adjacent to or abut the proposed wall or structure;
- (g) have a wall height or post height not exceeding 3m above natural ground level;
- (h) have a roof height where no part of the roof is more than 5m above the natural ground level; and
- (i) if clad in sheet metal, is pre-colour treated or painted in a non-reflective colour.

PO 12.2

Ancillary buildings and structures do not impede on-site functional requirements such as private open space provision, car parking requirements or result in over-development of the site.

DTS / DPF 12.2

Ancillary buildings and structures do not result in:

- (a) less private open space than specified in Design in Rural Areas Table 1 – Outdoor Open Space;
- (b) less on-site car parking than specified in Transport, Access and Parking Table 1 - Off-street Car Parking Requirements; and
- (c) the total roofed floor area of all existing or proposed ancillary building(s) or structure(s) exceeding 60m².

PO 12.3

Fixed plant and equipment in the form of pumps and/or filtration systems for a swimming pool or spa positioned and/or housed to not cause unreasonable noise nuisance to adjacent sensitive receivers.

DTS/DPF 12.3

The pump and/or filtration system is ancillary to a dwelling erected on the same site and is:

- (a) enclosed in a solid acoustic structure that is located at least 5m from the nearest habitable room located on an adjoining allotment; or
- (b) located at least 12m from the nearest habitable room located on an adjoining allotment.

RESIDENTIAL DEVELOPMENT - 3 BUILDING LEVELS OR LESS

External appearance

PO 13.1

Garaging designed to not detract from the streetscape or appearance of a dwelling.

DTS/DPF 13.1

Garages and carports facing a street:

- (a) do not exceed 7m in width or 50% of the sites frontage (whichever is less); and
- (b) are situated so that no part of the garage or carport will be in front of any part of the building line of the dwelling
- (c) are setback at least 5.5m from the boundary of the primary street;
- (d) unless the dwelling has two storeys along the street frontage:
 - i. have single width car parking with a maximum garage door not exceeding 3.5m on sites with a frontage of 12m or less
 - ii. have a garage door not exceeding 50% of the site frontage or 7m (whichever is less) on sites with a frontage greater than 12m.

PO 13.2

Dwelling facades make a positive contribution to streetscapes and common areas by providing variation of light and shadow and creating a sense of depth.

DTS/DPF 13.2

Each dwelling includes at least 3 of the following design features along each façade facing a public road or common driveway:

- (a) a minimum of 30% of the façade is setback an additional 300mm from the primary building line;
- (b) a porch or portico that projects at least 1m from the building façade that is open on at least 2 sides;
- (c) a balcony that projects from the building façade;
- (d) a verandah that projects at least 1m from the building façade;
- (e) eaves surrounding the dwelling of a minimum 450mm width;
- (f) a minimum 30% of the upper level projects forward from the lower level primary building line.

PO 13.3

The apparent mass of larger buildings is reduced when viewed from adjoining allotments or public streets.

DTS/DPF 13.3

Buildings of 2 or more building levels and a length exceeding 20m adjacent a secondary street or side boundary incorporate a step back of the building façade of at least 300mm for a minimum length of 1m, at least every 10m.

Overlooking / Visual Privacy

PO 14.1

Development mitigates direct overlooking of habitable rooms and private open spaces of dwellings.

DTS / DPF 14.1

Upper level windows facing side or rear boundaries shared with an allotment put to residential use:

- (a) are permanently obscured to a height of 1.5m above finished floor level that is fixed or not capable of being opened more than 200mm;
- (b) have sill heights greater than or equal to 1.5m above finished floor level; or
- (c) incorporate screening to a height of 1.5m above finished floor level; and
- (d) the building will not have a balcony or terrace on an upper building level, other than where the longest side of that balcony or terrace will face a road (including any road reserve), or reserve (including any land held as open space), and is at least 15m from the private open space of any other dwelling.

Private Open Space

PO 15.1

Dwellings provided with suitable sized areas of usable private open space to meet the needs of occupants.

DTS / DPF 15.1

Private open space provided in accordance with Design in Rural Areas Table 1 - Outdoor Open Space.

PO 15.2

Private open space positioned to provide convenient access from internal living areas.

DTS / DPF 15.2

Private open space is directly accessible from a habitable room, other than a bedroom or study.

PO 15.3

Private open space is positioned and designed to:

- (a) provide useable outdoor space that suits the needs of occupants;
- (b) take advantage of desirable orientation and vistas;
- (c) animate street frontages by encouraging activity between buildings and public streets;
- (d) adequately define public and private space where located forward of the building; and
- (e) prolong activity along street frontages by protecting against inclement weather.

DTS / DPF 15.3

A portion of the private open space specified in DTS 15.1 can be provided forward of the primary building line where:

- (a) the area is fenced to a maximum height of 1.8m;
- (b) the area incorporates a verandah with a minimum dimension of 1.5m; and
- (c) an area is provided behind the primary building line that has the minimum dimensions identified in DTS 15.1.

Water Sensitive Design

PO 16.1

Development creating 5-19 dwellings includes stormwater management systems that minimise the discharge of sediment, suspended solids, organic matter, nutrients, bacteria, litter and other contaminants to the stormwater system, watercourses or other water bodies.

DTS 16.1

Development creating 5-19 dwellings is accompanied by an approved Stormwater Management Plan that achieves the following stormwater runoff outcomes:

- (a) 80 per cent reduction in average annual total suspended solids;
- (b) 60 per cent reduction in average annual total phosphorus; and
- (c) 45 per cent reduction in average annual total nitrogen.

PO 16.2

Development creating 5-19 dwellings includes a stormwater management system designed to mitigate peak flows and manage the rate and duration of stormwater discharges from the site to ensure the carrying capacities of downstream systems are not overloaded.

DTS 16.2

Development creating 5-19 dwellings:

- (a) maintains:
 - i. a pre-development peak flow rate from the site based upon a 0.35 runoff coefficient for the 5-year ARI (18.1% AEP) 30 minute storm; and
 - ii. the stormwater runoff time to peak to match that of the pre-development condition; or
- (b) capture and retain the difference in pre-development runoff volume (based upon a 0.35 runoff coefficient) vs post development runoff volume from the site for a 5-year ARI (18.1% AEP) 30 minute storm; and
- (c) manage site generated stormwater runoff up to and including the 100 –year ARI flood event (1% AEP) to avoid flooding of buildings.

Car parking, access and manoeuvrability

PO 17.1

Covered parking spaces are of a size and dimensions to be functional, accessible and convenient.

DTS / DPF 17.1

Covered car parking spaces:

- (a) where enclosed by fencing or walls, have:
 - i. a minimum internal width of 3.2m and length of 6.0m for a single space;
 - ii. a minimum internal width of 6.0m and length of 6.0m for a double space (side by side); and
 - iii. a minimum internal width of 3.2m and length of 11m for a double space (tandem); or
- (b) where not enclosed by fencing, walls or garage doors, have:
 - i. a minimum width of 3.0m and minimum length of 5.5m for a single space;
 - ii. a minimum width of 5.2m and minimum length of 5.5m for a double (side by side) space; and
 - iii. a minimum width of 3.0m and minimum length of 10.4m for a double (tandem) space.

PO 17.2

Uncovered parking spaces are of a size and dimensions to be functional, accessible and convenient.

DTS / DPF 17.2

Uncovered car parking spaces have a minimum width of 2.4m and a minimum length of 5.5m.

PO 17.3

Driveways located and designed to facilitate safe access and egress while maximising land available for street tree planting, landscaped street frontages and on-street parking.

DTS / DPF 17.3

Driveways and access points:

- (a) for sites with a frontage to a public road of 12m or less, have a maximum width of 3.2m measured at the property boundary and are the only access point provided on the site; or
- (b) for sites with a frontage to a public road greater than 12m:
 - i. have a maximum width of 6m measured at the property and are the only access point provided on the site; or
 - ii. have a maximum width of 3.2 metres measured at the property boundary and no more than two access points are provided on site.

PO 17.4

Vehicle access is safe, convenient, minimises interruption to the operation of public roads and does not interfere with street infrastructure or street trees.

DTS / DPF 17.4

Vehicle access to designated car parking spaces:

- (a) is provided via a lawfully existing or authorised driveway or access point or an access point for which consent has been granted as part of an application for the division of land
- (b) where newly proposed, is setback:
 - i. 500mm or more from any street furniture, street pole, infrastructure services pit, or other stormwater or utility infrastructure unless consent is provided from the asset owner;
 - ii. 2m or more from a street tree unless consent is provided from the tree owner;
 - iii. 6m or more from the tangent point of an intersection of 2 or more roads or a pedestrian-actuated crossing.

PO 17.5

Driveways are designed to enable safe and convenient vehicle movements from the public road to on-site parking spaces.

DTS/ DPF 17.5

Driveways are designed and sited so that:

- (a) the gradient from the place of access on the boundary of the allotment to the finished floor level at the front of the garage or carport when work is completed is not steeper than 1:4 on average; and
- (b) the centre of the driveway at the public road boundary is no more than 25 degree deviation from the centre of the front of the covered car parking space for which it provides vehicle access.

PO 17.6

Driveways and access points are designed and distributed to optimise the provision of on-street visitor parking (where on-street parking is appropriate).

DTS / DPF 17.6

Where on-street parking is available directly adjacent the site, parking is retained in accordance with the following requirements:

- (a) 1 on-street car park per 3 proposed dwellings (rounded up to the nearest whole number); and
- (b) minimum car park length of 6m.

Waste storage

PO 18.1

Provision is made for the convenient storage of waste bins in a location screened from public view.

DTS / DPF 18.1

Dwellings are provided with:

- (a) an area of 3m² or more for the storage of waste (separate from any designated car parking spaces or private open space) is provided behind the building line; and
- (b) a continuous unobstructed path of travel with a minimum width of 800mm between the waste bin storage area and the street.

Design of Transportable Dwellings

PO 19.1

The sub-floor space beneath transportable buildings enclosed to give the appearance of a permanent structure.

DTS 19.1

None are applicable.

GROUP DWELLINGS, RESIDENTIAL FLAT BUILDINGS AND BATTLE-AXE DEVELOPMENT

Amenity

PO 20.1

Dwellings are of a suitable size to accommodate a layout that is well organised and provides high standard of amenity for occupants.

DTS / DPF 20.1

Dwellings have a minimum internal floor area in accordance with the following table:

Bedrooms	Minimum-internal-floor-area
1-bed	50m ²
2-bed	65m ²
3-bed	80m ² , and any dwelling over 3 bedrooms provides an additional 15m ² for every additional bedroom

PO 20.2

The orientation and siting of buildings minimises impacts on the amenity, outlook and privacy of occupants and neighbours.

DTS 20.2

None are applicable.

PO 20.3

Development maximises the number of dwellings that face public open space and public streets and limits dwellings oriented to towards neighbouring properties.

DTS 20.3

None are applicable.

Communal Open Space

PO 21.1

Communal open space provided where private open space provision is inadequate to meet the needs of occupants or where the nature of the development is such that private open space is not ordinarily provided.

DTS 21.1

None are applicable.

Car parking, access and manoeuvrability

PO 22.1

Driveways and access points are designed and distributed to optimise the provision of on-street visitor parking (where on-street parking is appropriate).

DTS / DPF 22.1

Where on-street parking is available directly adjacent the site, parking is retained in accordance with the following requirements:

- (a) 1 on-street car park per 3 proposed dwellings (rounded up to the nearest whole number); and
- (b) minimum car park length of 6m.

PO 22.2

The number of vehicular access points onto public roads is minimised to reduce interruption of the footpath and positively contribute to public safety and walkability.

DTS / DPF 22.2

Access to group dwellings or dwellings within a residential flat building provided via a single common driveway.

PO 22.3

Driveways, access points, access tracks and parking areas are designed and constructed to allow adequate movement and manoeuvrability having regard to the types of vehicles that are reasonably anticipated.

DTS / DPF 22.3

Driveways that service more than one dwelling have:

- a) a minimum width of 3m;
- b) incorporate a least one vehicle passing point with minimum width of 5m and minimum length of 6m, and an additional passing point at least every 25m thereafter;
- c) locate the passing point in (b) within 12m of the primary street boundary; and
- d) a width of 5m for at least the first 6m from the primary street boundary where located on an arterial road.

PO 22.4

Residential driveways that service more than one dwelling are designed to allow adequate movement.

DTS / DPF 22.4

Where in a battle-axe configuration, a driveway servicing one dwelling to have a minimum width of 3m.

PO 22.5

Residential driveways that service more than one dwelling are designed to allow passenger vehicles to enter and exit the site in a safe and convenient manner.

DTS / DPF 22.5

Driveways providing access to more than one dwelling allow a B85 passenger vehicle to enter and exit all dedicated car parks and garages in a forward direction without requiring more than a 3-point turn manoeuvre.

PO 22.6

Dwellings are adequately separated from common driveways and manoeuvring areas.

DTS/DPF 22.6

Dwellings are at least 1.5m from any vehicle movement path required to achieve DTS 21.5.

Landscaping

PO 23.1

Landscaping is provided between dwellings and common driveways to improve the outlook for occupants and improve the appearance of common areas.

DTS/ DPF 23.1

Other than where located directly in front of a garage or directly adjacent a building entry door, soft landscaping with a minimum dimension of 1m is provided between a dwelling and common driveway.

PO 23.2

Landscaping is provided that improves the appearance of common driveways.

DTS / DPF 23.2

Where a common driveway is located directly adjacent the side or rear boundary of the site, soft landscaping with a minimum dimension of 1m is provided between the driveway and site boundary (excluding along the perimeter of a passing point required in DTS 21.3).

Site Facilities / Waste Storage

PO 24.1

Provision is made for suitable mailbox facilities close to the major pedestrian entry to the site or conveniently located considering the nature of accommodation and mobility of occupants.

DTS 24.1

None are applicable.

PO 24.2

Provision is made for suitable external clothes drying facilities.

DTS 24.2

None are applicable.

PO 24.3

Provision is made for suitable household waste and recyclable material storage facilities conveniently located from public view.

DTS 24.3

None are applicable.

PO 24.4

Waste and recyclable material storage areas are located away from dwellings.

DTS / DPF 24.4

Dedicated waste and recyclable material storage areas are located at least 3m from any habitable room window.

PO 24.5

Provision is made for on-site waste collection where 10 or more bins are to be collected at any one time.

DTS 24.5

None are applicable.

SUPPORTED ACCOMMODATION, HOUSING FOR AGED PERSONS, AND PEOPLE WITH DISABILITIES

Siting and Configuration

PO 25.1

Supported accommodation and housing for aged persons and people with disabilities is located where on-site movement of residents is not unduly restricted by the slope of the land.

DTS 25.1

None are applicable.

Movement and Access

PO 26.1

Development is designed to support safe and convenient access and movement for residents by providing:

- (a) ground-level access or lifted access to all units;
- (b) level entry porches, ramps, paths, driveways, passenger loading areas and areas adjacent to footpaths that allow for the passing of wheelchairs and resting places;
- (c) car parks with gradients no steeper than 1-in-40, and of sufficient area to provide for wheelchair manoeuvrability; and
- (d) kerb ramps at pedestrian crossing points.

DTS 26.1

None are applicable.

Communal Open Space

PO 27.1

Development that is designed to provide attractive, convenient and comfortable indoor and outdoor communal areas to be used by residents and visitors alike.

DTS 27.1

None are applicable.

PO 27.2

Communal open space provided where private open space provision is inadequate to meet the needs of occupants or where the nature of the development is such that private open space is not ordinarily provided (such as supported accommodation).

DTS 27.2

None are applicable.

Site Facilities / Waste Storage

PO 28.1

Development that is designed to provide storage areas for personal items and specialised equipment such as small electric powered vehicles, including facilities for the recharging of small electric powered vehicles.

DTS 28.1

None are applicable.

PO 28.2

Provision is made for suitable mailbox facilities close to the major pedestrian entry to the site or conveniently located considering the nature of accommodation and mobility of occupants.

DTS 28.2

None are applicable.

PO 28.3

Provision is made for suitable external clothes drying facilities.

DTS 28.3

None are applicable.

PO 28.4

Provision is made for suitable household waste and recyclable material storage facilities conveniently located and screened from public view.

DTS 28.4

None are applicable.

PO 28.5

Waste and recyclable material storage areas are located away from dwellings.

DTS / DPF 28.5

Dedicated waste and recyclable material storage areas are located at least 3m from any habitable room window.

PO 28.6

Provision is made for on-site waste collection where 10 or more bins are to be collected at any one time.

DTS 28.6

None are applicable.

PO 28.7

Services including gas and water meters conveniently located and screened from public view.

DTS 28.7

None are applicable.

ALL NON-RESIDENTIAL DEVELOPMENT

Water Sensitive Design

PO 29.1

Development likely to result in significant risk of export of litter, oil or grease should include stormwater management systems designed to minimise pollutants entering stormwater.

DTS/DPF 29.1

Development likely to result in significant risk of export of litter, oil or grease should include stormwater management systems designed to achieve the following gross pollutant outcomes:

- (a) 90 per cent reduction of litter/gross pollutants compared to untreated stormwater runoff; and
- (b) no visible oils/grease for flows up to the 1-in-3 month average return interval flood peak flow.

PO 29.2

Water discharged from a development site to be of a physical, chemical and biological condition equivalent to or better than its pre-developed state.

DTS 29.2

None are applicable.

Wash-down and Waste Loading and Unloading

PO 30.1

Areas for activities including loading and unloading, storage of waste refuse bins in commercial and industrial development or wash-down areas used for the cleaning of vehicles, plant or equipment that are:

- (a) designed to contain all wastewater likely to pollute stormwater within a bunded and roofed area to exclude the entry of external surface stormwater run-off;
- (b) paved with an impervious material to facilitate wastewater collection;
- (c) of sufficient size to prevent 'splash-out' or 'over-spray' of wastewater from the wash-down area; and
- (d) designed to drain wastewater to either:
 - i. a treatment device such as a sediment trap and coalescing plate oil separator with subsequent disposal to a sewer, private or Community Wastewater Management Scheme; or
 - ii. a holding tank and its subsequent removal off-site on a regular basis.

DTS 30.1

None are applicable.

Table 1 - Outdoor Open Space

Dwelling Type	Dwelling / Site Configuration	Minimum Rate
Detached dwelling	Site area 1,000m ² or greater	Total area: 20% of total site area
Semi-detached dwelling		Adjacent to habitable room: 10% total site area / minimum dimension 4m.
Row dwelling		

Dwelling Type	Dwelling / Site Configuration	Minimum Rate
Group dwelling	Site area 500m ² to <1,000m ²	Total area: 80m ² Adjacent to habitable room: 24m ² / minimum dimension 4m.
	Site area 300m ² to <500m ²	Total area: 60m ² Adjacent to habitable room: 16m ² / minimum dimension 4m.
	Site area <300m ²	Total area: 24m ² Adjacent to habitable room: 16m ² / minimum dimension 3m
Cabin or caravan (permanently fixed to the ground) in a Residential Park Zone or Caravan and Tourist Park Zone		Total area: 16m ² , which may be used as second car parking space, provided on each site intended for residential occupation.

Forestry

Assessment Provisions (AP)

Desired Outcomes (DO)

DO 1

Commercial forestry designed and sited to maximise economic benefits whilst managing potential negative impacts on the environment, transport networks, surrounding land uses and landscapes.

Performance Outcomes and Deemed to Satisfy / Designated Performance Outcome Criteria

Siting

PO 1.1

Commercial forestry plantations established where there is no clearance of valued trees or substantially intact strata of native vegetation, or where there is no detrimental effect on the physical environment or scenic quality of the rural landscape.

DTS/DPF 1.1

None are applicable.

PO 1.2

Commercial forestry plantations established on slopes that are stable to minimise the risk of soil erosion.

DTS/DPF 1.2

Commercial forestry plantations are not located on land with a slope exceeding 20% (1-in-5).

PO 1.3

Commercial forestry plantations and operations associated with their establishment, management and harvesting appropriately setback from a sensitive receiver to minimise fire risk and noise disturbance.

DTS/DPF 1.3

Commercial forestry plantations and operations associated with their establishment, management and harvesting are setback 50m or more from any sensitive receiver.

PO 1.4

Commercial forestry plantations separated from reserves gazetted under the National Parks and Wildlife Act 1972 and/or Wilderness Protection Act 1992 to minimise fire risk and potential for weed infestation.

DTS/DPF 1.4

Commercial forestry plantations and operations associated with their establishment, management and harvesting are setback 50m or more of a reserve gazetted under the *National Parks and Wildlife Act 1972* or *Wilderness Protection Act 1992*.

Water Protection

PO 2.1

Commercial forestry plantations incorporate artificial drainage lines (ie culverts, runoffs and constructed drains) integrated with natural drainage lines to minimise concentrated water flows onto or from plantation areas.

DTS/DPF 2.1

None are applicable

PO 2.2

Appropriate siting, layout and design measures adopted to minimise the impact of commercial forestry plantations on surface water resources.

DTS/DPF 2.2

Commercial forestry plantations:

- (a) do not involve cultivation (excluding spot cultivation) in drainage lines;
- (b) are setback 20m or more from the banks of any major watercourse (a third order or higher watercourse), lake, reservoir, wetland and sinkhole (direct connection to aquifer); and
- (c) are setback 10m or more from the banks of any first or second order watercourse or sinkhole (no-direct connection to aquifer).

Fire Management

PO 3.1

Commercial forestry plantations incorporate appropriate firebreaks and fire management design elements.

DTS/DPF 3.1

Commercial forestry plantations provide:

- (a) 7m or more wide external boundary firebreaks for plantations of 40ha or less;
- (b) 10m or more wide external boundary firebreaks for plantations of between 40ha and 100ha; or
- (c) 20m or more wide external boundary firebreaks, or 10m with an additional 10m or more of fuel-reduced plantation, for plantations of 100ha or greater.

PO 3.2

Commercial forestry plantations incorporate appropriate fire management access tracks.

DTS/DPF 3.2

Commercial forestry plantation fire management access tracks:

- (a) are incorporated within all firebreaks;
- (b) are 7m or more wide with a vertical clearance of 4m or more;
- (c) are aligned to provide straight through access at junctions, or if they are a no through access track are appropriately signposted and provide suitable turnaround areas for fire-fighting vehicles; and
- (d) partition the plantation into units 40ha or less in area.

Power-line Clearances

PO 4.1

Commercial forestry plantations achieve and maintain appropriate clearances from aboveground power-lines.

DTS/DPF 4.1

Commercial forestry plantations incorporating trees with an expected mature height of greater than 6m meet the clearance requirements listed in the following table:

Voltage of transmission line	Tower or Pole	Minimum horizontal clearance distance between plantings and transmission lines
500 kV	Tower	38m
275 kV	Tower	25m
132 kV	Tower	30m
132 kV	Pole	20m
66 kV	Pole	20m
Less than 66 kV	Pole	20m

Housing Renewal

Assessment Provisions (AP)

Desired Outcomes (DO)

DO 1

Renewed residential environments to replace older social housing, provide new social housing infrastructure and other housing options and tenures to enhance the residential amenity of the local area.

Performance Outcomes and Deemed to Satisfy / Designated Performance Outcome Criteria

Land Use and Intensity

PO 1.1

Residential development provides a range of housing choices.

DTS/DPF 1.1

Development comprises:

- (a) detached dwellings;
- (b) semi-detached dwellings;
- (c) row dwellings;
- (d) group dwellings; or
- (e) residential flat buildings, except where incorporating above-ground dwellings.

PO 1.2

Higher density housing options (such as medium rise residential flat buildings) provided in close proximity to public transit, open space or activity centres.

DTS/DPF 1.2

None are applicable.

Building Height

PO 2.1

Buildings contribute to a low-to-medium rise suburban character.

DTS/DPF 2.1

Building height (excluding garages, carports and outbuildings) does not exceed 3 building levels and 12m and wall height does not exceed 9m, except in the case of a gable end.

PO 2.2

Medium rise buildings in locations close to public transit, centres or open space.

DTS/DPF 2.2

None are applicable.

PO 2.3

Medium rise residential flat buildings located within or at the interface with zones which restrict heights to a maximum of 2 storeys transition down in scale and height towards the periphery (side and rear boundaries) of the site.

DTS/DPF 2.3

None are applicable.

Primary Street Setback

PO 3.1

Buildings are set back from the primary street boundary in a manner which is compatible with the desired outcomes of the area.

DTS/DPF 3.1

Buildings (excluding any balcony, verandah, porch, awning or similar structure) are set back from the primary street boundary 3m or more.

Secondary Street Setback

PO 4.1

Buildings are set back from secondary street boundaries to maintain separation between building walls and public streets and contribute to a suburban streetscape character.

DTS/DPF 4.1

Buildings are set back from any secondary street allotment boundary:

- (a) 900mm or more for any wall up to 6 metres in height
- (b) 2m or more for any wall above 6 metres in height.

Boundary Walls

PO 5.1

Boundary walls are limited in height and length to manage visual impacts and access to natural light and ventilation.

DTS/DPF 5.1

Except where the dwelling is located on a central site within a row dwelling or terrace arrangement, dwellings with side boundary walls are sited on only one side boundary and either:

- (a) adjoin or abut a boundary wall of a building on adjoining land for the same length and height; or do not exceed the following:
 - i. 3m in wall height;
 - ii. 10m in length; and
- (b) setback 3m or more from any other existing or proposed boundary walls on the subject land.

PO 5.2

Dwellings in a semi-detached, row or terrace arrangement maintain space between buildings consistent with a suburban streetscape character.

DTS/DPF5.2

Dwellings in a semi-detached or row arrangement are setback 900mm or more from side boundaries shared with allotments outside the development site, except for a carport or garage.

Side Boundary Setback

PO 6.1

Buildings are set back from side boundaries to provide:

- (a) separation between dwellings in a way that contributes to a suburban character; and
- (b) access to natural light and ventilation for neighbours.

DTS/DPF 6.1

Other than walls located on a side boundary, buildings are set back from side boundaries:

- (a) 900mm or more where the wall is up to 3m measured from the top of the footings;
- (b) other than for a wall facing a southern side boundary, 900mm or more plus 1/3 of the wall height above 3m measured from the top of the footings; and
- (c) at 1.9m or more plus 1/3 of the wall height above 3m measured from the top of the footings for walls facing a southern side boundary.

Rear Boundary Setback

PO 7.1

Buildings are set back from rear boundaries to provide:

- (a) separation between dwellings in a way that contributes to a suburban character;
- (b) access to natural light and ventilation for neighbours;
- (c) private opens space; and
- (d) space for landscaping and vegetation.

DTS/DPF 7.1

Dwellings are set back from rear boundary:

- (a) 3m or more for the first building level; and
- (b) 5m or more for any subsequent building level.

Façade design

PO 8.1

Dwelling facades facing public streets and common driveways make a positive contribution to the streetscape.

DTS/DPF 8.1

Each dwelling includes at least 2 of the following design features along each façade facing a public road or common driveway:

- (a) a minimum of 25% of the façade is setback an additional 300mm
- (b) a porch or portico that projects at 1m or more from the building façade and is open on least 2 sides
- (c) a balcony that projects 1.0m or more from the building façade
- (d) a verandah that projects at least 1m from the building façade
- (e) eaves surrounding the dwelling of a minimum 450mm width
- (f) a minimum 50% of the upper level projects forward a minimum 300mm from the lower level building line.

PO 8.2

Dwellings incorporate windows along primary street frontages to encourage passive surveillance and make a positive contribution to the streetscape.

DTS/DPF 8.2

Each dwelling with a frontage to a public street or common driveway includes at least one window with a total window area of at least 2m² facing the primary street or common driveway, from a habitable room that has minimum room dimension of 2.7m.

PO 8.3

The visual bulk of larger buildings is reduced when viewed from adjoining allotments or public streets, such as through the incorporation of windows, articulation, building materials and textures.

DTS/DPF 8.3

None are applicable.

PO 8.4

Built form considers local context and provides a quality design response through scale, massing, materials, colours and architectural expression.

DTS/DPF 8.4

None are applicable.

PO 8.5

Entrances to apartment buildings are:

- (a) oriented towards the street
- (b) visible and easily identifiable from the street
- (c) designed to include a common mail box structure.

DTS/DPF 8.5

None are applicable.

Outlook and amenity

PO 9.1

Primary living rooms have an external outlook to provide a high standard of internal amenity for occupants.

DTS/DPF 9.1

None are applicable.

PO 9.2

Ground level bedrooms separated or shielded from active communal recreation areas, common access areas and vehicle parking areas and access ways to mitigate noise and artificial light intrusion.

DTS/DPF 9.2

None are applicable.

Private Open Space

PO 10.1

Dwellings provided with suitable sized areas of usable private open space to meet the needs of occupants.

DTS/DPF 10.1

Private open space provided in accordance with the following table:

Dwelling-site-size ^a		Minimum area of POS ^x	Minimum [¶] dimension ^x
> 500m ² ^x		80m ² ^x	4m ^x
300--500m ² ^x		60m ² ^x	4m ^x
200--300m ² ^x		24m ² ^x	3m ^x
<200 ^x	Three+ bedroom ^x	15·m ² ^x	3m ^x
	Two bedroom ^x	11·m ² ^x	2.5m ^x
	One bedroom ^x	8·m ² ^x	2m ^x
	Studio ^x	8·m ² ^x	2m ^x

PO 10.2

Private open space positioned to provide convenient access from internal living areas.

DTS/DPF 10.2

At least 50% of the required area of private open space is accessible from a habitable room, other than a study or bedroom.

PO 10.3

Private open space is positioned and designed to:

- (a) provide useable outdoor space that suits the needs of occupants;
- (b) take advantage of desirable orientation and vistas; and
- (c) adequately define public and private space.

DTS/DPF 10.3

None are applicable.

Visual privacy

PO 11.1

Development mitigates direct overlooking of habitable rooms and private open spaces of adjacent dwellings.

DTS/DPF11.1

Upper level windows facing side or rear boundaries shared with an allotment put to residential use:

- (a) are permanently obscured to a height of 1.5m above finished floor level that is fixed or not capable of being opened more than 200mm;
- (b) have sill heights greater than or equal to 1.5m above finished floor level; or
- (c) incorporate screening to a height of 1.5m above finished floor level.

PO 11.2

Balconies are sited and screened to minimise direct overlooking of adjacent dwellings.

DTS/DPF11.2

The building:

- (a) will not have a balcony on an upper storey; or
- (b) the longest side of a balcony faces a road (including any road reserve) or reserve (including any land held as open space); and

- (c) the balcony is 15m or more from the private open space of any other dwelling.

Landscaping

PO 12.1

Soft landscaping incorporated into development to:

- (a) minimise heat absorption and reflection;
- (b) maximise shade and shelter;
- (c) maximise stormwater infiltration and biodiversity; and
- (d) enhance the appearance of land and streetscapes.

DTS/DPF 12.1

Residential development incorporates areas for soft landscaping with a minimum dimension of 0.5 metres provided in accordance with the following:

Dwelling-site-area-(or-in-the-case-of-residential-flat-building-or-group-dwellings,-average-site-area)-(m ²)	%-of-site-
<200	15%
201--450	20%
>450	25%

(a)

; and

- (b) 25% of land between the road boundary and the primary building line is provided for soft landscaping with a minimum dimension of 1.5 metres.

Water Sensitive Design

PO 13.1

Residential development designed to capture and re-use stormwater to maximise conservation of water resources, manage peak stormwater runoff flows and volume and manage runoff quality to maintain, as close as is practical, pre development conditions.

DTS/DPF 13.1

None are applicable.

Parking

PO 14.1

On-site car parking provided to meet the anticipated demand of residents, with less on-site parking appropriate in areas in close proximity to public transport stations.

DTS/DPF 14.1

On-site car parking is provided at the following rates:

- (a) 2 or less bedroom dwelling – 1 car parking space, covered or able to be covered (without impinging on building setbacks);
- (b) 3 or more bedroom dwelling - 2 car parking spaces, 1 of which is covered or able to be covered (without impinging on building setbacks).

PO 14.2

Covered car parking spaces are of dimensions to be functional, accessible and convenient.

DTS/DPF 14.2

Covered car parking spaces:

(a) where enclosed by fencing or walls, have:

- i. a minimum internal width of 3.2m and length of 6.0m for a single garage;
- ii. a minimum internal width of 6.0m and length of 6.0m for a double garage (side by side);
and
- iii. a minimum internal width of 3.2m and length of 11m for a double garage (tandem); or

(b) carports not enclosed by fencing, walls or garage doors, have:

- i. a minimum width of 3.0m and minimum length of 5.5m for a single width carport;
- ii. a minimum width of 5.2m and minimum length of 5.5m for double carports (side by side);
and
- iii. a minimum width of 3.0m and minimum length of 10.4m for double carport (tandem).

PO 14.3

Uncovered car parking spaces are of dimensions to be functional, accessible and convenient.

DTS/DPF 14.3

Uncovered car parking spaces have a minimum width of 2.4m and minimum length of 5.5m.

PO 14.4

Residential flat buildings and group dwelling developments provide sufficient on-site visitor car parking to cater for anticipated demand.

DTS/DPF 14.4

Visitor car parking for group and residential flat buildings incorporating 4 or more dwellings is provided on-site at a minimum ratio of 0.25 car parking spaces per dwelling.

PO 14.5

Residential flat buildings provide dedicated areas for bicycle parking

DTS/DPF 14.4

Residential flat buildings provide one bicycle parking space per dwelling.

Overshadowing

PO 15.1

Development minimises overshadowing of the private open spaces of adjoining land by ensuring that ground level open space associated with existing residential buildings receive direct sunlight for a minimum of 2 hours between 9am and 3pm on 21 June.

DTS/DPF 15.1

None are applicable.

Waste

PO 16.1

Provision is made for the convenient storage of waste bins in a location screened from public view.

DTS/DPF 16.1

Dwellings are provided with:

- (a) an area of 3m² or more for the storage of waste (separate from any designated car parking spaces or private open space) is provided behind the building line; and
- (b) a continuous unobstructed path of travel with a minimum width of 800mm is provided between the waste storage area and the street.

PO 16.2

Residential apartment buildings provide a dedicated area for the on-site storage of waste which is:

- (a) easily and safely accessible for residents and for collection vehicles;
- (b) screened from adjoining land and public roads; and
- (c) of sufficient dimensions to be able to accommodate the waste storage needs of the development considering the intensity and nature of the development and the frequency of collection.

DTS/DPF 16.2

None are applicable.

Vehicle Access

PO 17.1

Driveways located and designed to facilitate safe access and egress while maximising land available for street tree planting, landscaped street frontages and on-street parking.

DTS/DPF 17.1

None are applicable.

PO 17.2

Vehicle access is safe, convenient, minimises interruption to the operation of public roads and does not interfere with street infrastructure or street trees

DTS/DPF 17.2

Vehicle access to designated car parking spaces:

- (a) is provided via a lawfully existing or authorised driveway or access point or an access point for which consent has been granted as part of an application for the division of land
- (b) where newly proposed, is setback:
 - i. 500mm or more from any street furniture, street pole, infrastructure services pit, or other stormwater or utility infrastructure unless consent is provided from the asset owner;
 - ii. 2m or more from a street tree unless consent is provided from the tree owner;
 - iii. 6m or more from the tangent point of an intersection of 2 or more roads or a pedestrian-actuated crossing.

PO 17.3

Driveways are designed to enable safe and convenient vehicle movements from the public road to on-site parking spaces

DTS/DPF/ DPF 17.3

Driveways are designed and sited so that:

- (a) the gradient from the place of access on the boundary of the allotment to the finished floor level at the front of the garage or carport when work is completed is not steeper than 1:4 on average; and
- (b) the centre of the driveway at the public road boundary is no more than 25 degree deviation from the centre of the front of the covered car parking space for which it provides vehicle access.

PO 17.4

Driveways and access points are designed and distributed to optimise the provision of on-street visitor parking (where on-street parking is appropriate).

DTS/DPF17.4

Where on-street parking is available directly adjacent the site, parking is retained in accordance with the following requirements:

- (a) 1 on-street car park per 3 proposed dwellings (rounded up to the nearest whole number); and
- (b) minimum car park length of 6m.

PO 17.5

Driveways, access points, access tracks and parking areas are designed and constructed to allow adequate movement and manoeuvrability having regard to the types of vehicles that are reasonably anticipated.

DTS/DPF 17.5

Battle-axe driveways and driveways that service more than one dwelling satisfy the following:

- (a) a width of 3m or more;
- (b) for driveways servicing three or more dwellings which exceed 30m in length, incorporate a least one vehicle passing point with a width of 5m or more and a length of 6m or more, and an additional passing point at least every 30m thereafter;
- (c) locate the passing point in (b) within 12m of the primary street boundary; and
- (d) a width of 5m or more for at least the first 6m from the primary street boundary where located on an arterial road.

PO 17.6

Residential driveways that service more than one dwelling are designed to allow passenger vehicles to enter and exit the site in a safe and convenient manner.

DTS/DPF 17.6

Driveways providing access to more than one dwelling allow a B85 passenger vehicle to enter and exit all dedicated car parks and garages in a forward direction without requiring more than a 2-point-turn manoeuvre.

PO 17.7

Dwellings are adequately separated from common driveways and manoeuvring areas.

DTS/DPF 17.7

Dwellings are set back 0.5m or more from any vehicle movement path required to achieve DTS/DPF 18.6.

Storage

PO 18.1

Dwellings are provided with sufficient space for storage to meet likely occupant needs.

DTS/DPF 18.1

Storage provided at the following rates:

- (a) 1 bedroom: 6m³;
- (b) 2 bedroom: 10m³;
- (c) 3+ bedroom: 12m³; and

50% or more of the storage volume is provided within the dwelling.

Earthworks

PO 19.1

Buildings are designed and sited to minimise alteration of existing landform.

DTS/DPF 19.1

The development does not involve:

- (a) excavation exceeding a vertical height of 1m;
- (b) filling exceeding a vertical height of 1m; and
- (c) a total combined excavation and filling vertical height exceeding 2m.

Service connections and infrastructure

PO 20.1

Dwellings are provided with appropriate service connections and infrastructure.

DTS/DPF 20.1

The applicant has certified that the site and building:

- (a) has the ability to be connected to a permanent potable water supply;
- (b) has the ability to be connected to a sewerage system, or a waste water control system approved under Public and Environmental Health Act 1987;
- (c) has the ability to be connected to electricity supply;
- (d) has the ability to be connected to an adequate water supply (and pressure) for fire-fighting purposes where located in a Hazard (Bushfire Risk) Overlay; and
- (e) would not be contrary to the Regulations prescribed for the purposes of Section 86 of the Electricity Act 1996.

Site contamination

PO 21.1

Development sites are suitable and safe for the intended land use, including remediation where required.

DTS/DPF 21.1

The applicant has provided a declaration indicating, to the best of his or her knowledge and belief, the allotment is not, and has not been, subject to site contamination as a result of a previous use of the land or a previous activity on the land or in the vicinity of the land.

Procedural Matters (PM)

Notification

All development undertaken by:

- i) the South Australian Housing Trust either individually or jointly with other persons or bodies;
or
- ii) registered Community Housing providers participating in housing renewal programs endorsed by the South Australian Housing Authority

is exempt from notification, except for a residential flat building (apartment building) of 3 storeys or greater.

Interface between Land Uses

Assessment Provisions (AP)

Desired Outcome (DO)	
<p>DO 1</p> <p>Development located and designed to mitigate adverse effects on neighbouring and proximate land uses to reduce potential for conflict.</p>	
Performance Outcome (PO)	<ul style="list-style-type: none"> • Deemed to Satisfy Criteria (DTS) (required for development to be classified as Deemed-to-Satisfy) • Designated Performance Feature (DPF) (used for development to be assessed on its merits against the applicable policies of the Planning and Design Code)
General Land Use Compatibility	
<p>PO 1.1</p> <p>Sensitive receivers designed and sited to protect residents and occupants from adverse impacts generated by lawfully existing land uses and land uses desired in the zone.</p>	None are applicable.
<p>PO 1.2</p> <p>Development adjacent to a site containing an existing sensitive receiver or zone primarily intended to accommodate sensitive receivers designed to minimise adverse impacts.</p>	None are applicable.
Hours of Operation	
<p>PO 2.1</p> <p>Non-residential development does not unreasonably impact the amenity of existing sensitive receivers or an adjacent zone primarily for sensitive receivers through hours of operation having regard to:</p> <ul style="list-style-type: none"> (a) the nature of the development; (b) measures to mitigate off-site impacts; (c) the extent to which the development is desired in the zone; and 	<p>DTS/DPF 2.1</p> <p>Consulting room, office and shop hours of operation are limited to 7am – 9pm Monday to Friday and 8am – 5pm Saturday inclusive.</p>

Performance Outcome (PO)	<ul style="list-style-type: none"> • Deemed to Satisfy Criteria (DTS) (required for development to be classified as Deemed-to-Satisfy) • Designated Performance Feature (DPF) (used for development to be assessed on its merits against the applicable policies of the Planning and Design Code)
(d) measures that might be taken in an adjacent zone primarily for sensitive receivers that mitigate adverse impacts without unreasonably compromising the intended use of that land.	
Overshadowing	
<p>PO 3.1</p> <p>Overshadowing of habitable room windows of adjacent residential land uses not unreasonably interrupted to maintain access to direct winter sunlight.</p>	<p>DTS/DPF 3.1</p> <p>North-facing windows of habitable rooms of adjacent residential land uses receive at least 3 hours of direct sunlight over their surface between 9.00 am and 3.00 pm on 21 June.</p>
<p>PO 3.2</p> <p>Overshadowing of the primary area of private open space or communal open space of adjacent residential land uses not unreasonably interrupted to maintain access to direct winter sunlight.</p>	<p>DTS/DPF 3.2</p> <p>Development maintains 2 hours direct sunlight between 9.00 am and 3.00 pm on 21 June to adjacent residential land uses in accordance with the following:</p> <ul style="list-style-type: none"> (a) for ground level private open space, the smaller of the following: <ul style="list-style-type: none"> (i) half of the existing ground level open space; or (ii) 35m² of the existing ground level open space (with at least one of the area's dimensions measuring 2.5m); (b) for ground level communal open space, at least half of the existing ground level open space.
<p>PO 3.3</p> <p>Development does not unduly reduce the generating capacity of existing rooftop solar energy facilities taking into account:</p> <ul style="list-style-type: none"> (a) the form of development contemplated in the relevant zone; 	None are applicable.

Performance Outcome (PO)	<ul style="list-style-type: none"> • Deemed to Satisfy Criteria (DTS) (required for development to be classified as Deemed-to-Satisfy) • Designated Performance Feature (DPF) (used for development to be assessed on its merits against the applicable policies of the Planning and Design Code)
<p>(b) the orientation of the solar energy facilities to operate effectively and efficiently; and</p> <p>(c) the extent to which the solar energy facilities are already overshadowed.</p>	
<p>PO 3.4</p> <p>Development that incorporates moving parts, including windmills and wind farms, located and operated to not cause unreasonable nuisance to nearby dwellings and tourist accommodation caused by shadow flicker.</p>	<p>None are applicable.</p>
<p>Activities Generating Noise or Vibration</p>	
<p>PO 4.1</p> <p>Development that emits noise (other than music noise) does not unreasonably impact acoustic amenity at the nearest existing sensitive receivers.</p>	<p>DTS/DPF 4.1</p> <p>Predicted noise at the nearest existing sensitive receiver achieves the relevant Environment Protection (Noise) Policy criteria.</p>
<p>PO 4.2</p> <p>Areas for the on-site manoeuvring of service and delivery vehicles, plant and equipment, outdoor work spaces (and the like) are designed and sited to not unreasonably impact the amenity of adjacent sensitive receivers and zones primarily intended to accommodate sensitive receivers due to noise and vibration by adopting techniques including:</p> <p>(a) locating openings of buildings and associated services away from the interface with the adjacent sensitive receivers and zones primarily intended to accommodate sensitive receivers;</p> <p>(b) when sited outdoors, locating such areas as far as practicable from adjacent sensitive receivers and zones primarily</p>	<p>None are applicable.</p>

Performance Outcome (PO)	<ul style="list-style-type: none"> • Deemed to Satisfy Criteria (DTS) (required for development to be classified as Deemed-to-Satisfy) • Designated Performance Feature (DPF) (used for development to be assessed on its merits against the applicable policies of the Planning and Design Code)
<p>intended to accommodate sensitive receivers;</p> <p>(c) housing plant and equipment within an enclosed structure or acoustic enclosure; and</p> <p>(d) providing a suitable acoustic barrier between the plant and / or equipment and the adjacent sensitive receiver boundary or zone.</p>	
<p>PO 4.3</p> <p>Fixed plant and equipment in the form of pumps and/or filtration systems for a swimming pool or spa positioned and/or housed to not cause unreasonable noise nuisance to adjacent sensitive receivers.</p>	<p>DTS/DPF 4.3</p> <p>The pump and/or filtration system is ancillary to a dwelling erected on the same site and is:</p> <ul style="list-style-type: none"> (a) enclosed in a solid acoustic structure that is located at least 5m from the nearest habitable room located on an adjoining allotment; or (b) located at least 12m from the nearest habitable room located on an adjoining allotment.
<p>PO 4.4</p> <p>External noise into bedrooms minimised by separating or shielding these rooms from service equipment areas and fixed noise sources located on the same or an adjoining allotment.</p>	<p>DTS/DPF 4.4</p> <p>Adjacent land is used for residential purposes.</p>
<p>PO 4.5</p> <p>Outdoor areas associated with licensed premises (such as beer gardens or dining areas) designed and/or sited to not cause unreasonable noise impact on existing adjacent sensitive receivers.</p>	<p>DTS/DPF 4.4</p> <p>None are applicable.</p>

Performance Outcome (PO)	<ul style="list-style-type: none"> • Deemed to Satisfy Criteria (DTS) (required for development to be classified as Deemed-to-Satisfy) • Designated Performance Feature (DPF) (used for development to be assessed on its merits against the applicable policies of the Planning and Design Code)
---------------------------------	---

<p>PO 4.6</p> <p>Development incorporating music achieves suitable acoustic amenity when measured at the boundary of an adjacent sensitive receiver or zone primarily intended to accommodate sensitive receivers.</p>	<p>DTS/DPF 4.6</p> <p>Development incorporating music includes noise attenuation measures that will achieve the following noise levels:</p> <table border="1" style="width: 100%; border-collapse: collapse;"> <thead> <tr style="background-color: #d9e1f2;"> <th style="padding: 5px;">Assessment location</th> <th style="padding: 5px;">Music noise level</th> </tr> </thead> <tbody> <tr> <td style="padding: 5px;">Externally at the nearest existing noise sensitive location</td> <td style="padding: 5px;">Less than 8dB above the level of background noise (L_{90,15min}) in any octave band of the sound spectrum (LOCT_{10,15} < LOCT_{90,15} + 8dB)</td> </tr> </tbody> </table>	Assessment location	Music noise level	Externally at the nearest existing noise sensitive location	Less than 8dB above the level of background noise (L _{90,15min}) in any octave band of the sound spectrum (LOCT _{10,15} < LOCT _{90,15} + 8dB)
Assessment location	Music noise level				
Externally at the nearest existing noise sensitive location	Less than 8dB above the level of background noise (L _{90,15min}) in any octave band of the sound spectrum (LOCT _{10,15} < LOCT _{90,15} + 8dB)				

Air Quality

<p>PO 5.1</p> <p>Development with the potential to emit harmful or nuisance-generating air pollution incorporates air pollution control measures to prevent harm to human health or unreasonably impact the amenity of existing sensitive receivers within the locality and zones primarily intended to accommodate sensitive receivers.</p>	<p>DTS/DPF 5.1</p> <p>None are applicable.</p>
---	---

<p>PO 5.2</p> <p>Development that includes chimneys or exhaust flues (including cafes, restaurants and fast food outlets) is designed to minimise nuisance or adverse health impacts to nearby sensitive receivers by:</p> <ul style="list-style-type: none"> (a) incorporating appropriate treatment technology before exhaust emissions are released; and (b) locating and designing chimneys or exhaust flues to maximise dispersion of exhaust emissions taking into account 	<p>DTS/DPF 5.2</p> <p>None are applicable.</p>
---	---

Performance Outcome (PO)	<ul style="list-style-type: none"> • Deemed to Satisfy Criteria (DTS) (required for development to be classified as Deemed-to-Satisfy) • Designated Performance Feature (DPF) (used for development to be assessed on its merits against the applicable policies of the Planning and Design Code)
the location of nearby sensitive receivers.	
Light Spill	
PO 6.1 External lighting positioned and designed to not cause unreasonable light spill impact on adjacent sensitive receivers.	DTS/DPF 6.1 None are applicable.
PO 6.2 External lighting is not hazardous to motorists and cyclists.	DTS/DPF 6.2 None are applicable.
Solar Reflectivity / Glare	
PO 7.1 Development designed and comprised of materials and finishes that do not unreasonably cause a distraction to adjacent road users and pedestrian areas or unreasonably cause heat loading and micro-climatic impacts on adjacent buildings and land uses as a result of reflective solar glare.	DTS/DPF 7.1 None are applicable.
Electrical Interference	
PO 8.1 Development in rural and remote areas does not unreasonably diminish or result in the loss of existing communication services due to electrical interference.	DTS/DPF 8.1 The building or structure: <ul style="list-style-type: none"> (a) is no greater than 10m in height, measured from existing ground level; or (b) is not within a line of sight between an existing fixed transmitter and fixed receiver (antenna) other than where an alternative service is available (via a different fixed transmitter or cable).

Performance Outcome (PO)	<ul style="list-style-type: none"> • Deemed to Satisfy Criteria (DTS) (required for development to be classified as Deemed-to-Satisfy) • Designated Performance Feature (DPF) (used for development to be assessed on its merits against the applicable policies of the Planning and Design Code)
---------------------------------	---

Interface with Rural Activities
--

<p>PO 9.1</p> <p>Sensitive receivers located and designed to mitigate impacts from lawfully existing horticultural and farming activities including chemical spray drift and noise.</p>	<p>DTS/DPF 9.1</p> <p>None are applicable.</p>
<p>PO 9.2</p> <p>Sensitive receivers located and designed to mitigate potential impacts from lawfully existing intensive animal husbandry activities and not prejudice the continued operation of these activities.</p>	<p>None are applicable.</p>
<p>PO 9.3</p> <p>Sensitive receivers located and designed to mitigate potential impacts from lawfully existing land-based aquaculture activities and not prejudice the continued operation of these activities.</p>	<p>DTS/DPF 9.3</p> <p>Sensitive receivers are located at least 200m from the boundary of a site used for land-based aquaculture and associated components in other ownership.</p>
<p>PO 9.4</p> <p>Sensitive receivers located and designed to mitigate potential impacts from lawfully existing dairies including associated wastewater lagoons and liquid/solid waste storage and disposal facilities and not prejudice the continued operation of these activities.</p>	<p>DTS/DPF 9.4</p> <p>Sensitive receivers sited at least 500m from the boundary of a site used for a dairy and associated wastewater lagoon(s) and liquid/solid waste storage and disposal facilities in other ownership.</p>
<p>PO 9.5</p> <p>Sensitive receivers located and designed to mitigate potential impacts from lawfully existing facilities used for the handling, transportation and storage of bulk commodities (recognising the potential for extended hours of operation) and not</p>	<p>DTS/DPF 9.5</p> <p>Sensitive receivers are located at least 300m from the boundary of a site used for the handling, transportation and storage of bulk commodities in other ownership.</p>

Performance Outcome (PO)	<ul style="list-style-type: none"> • Deemed to Satisfy Criteria (DTS) (required for development to be classified as Deemed-to-Satisfy) • Designated Performance Feature (DPF) (used for development to be assessed on its merits against the applicable policies of the Planning and Design Code)
prejudice the continued operation of these activities.	
<p>PO 9.6</p> <p>Setbacks and vegetation plantings along allotment boundaries should be incorporated to mitigate the potential impacts of chemical spray drift and other impacts associated with agricultural and horticultural activities.</p>	None are applicable.
<p>PO 9.7</p> <p>Urban development should not prejudice existing agricultural and horticultural activities through appropriate separation and design techniques.</p>	None are applicable.
Interface with Mines and Quarries (Rural and Remote Areas)	
<p>PO 10.1</p> <p>Sensitive receivers are separated from existing mines to minimise adverse impacts from noise, dust and vibration.</p>	<p>DTS/DPF 10.1</p> <p>Sensitive receivers are located no closer than 500m from the boundary of a Mining Production Tenement under the <i>Mining Act 1971</i>.</p>

Infrastructure and Renewable Energy Facilities

Assessment Provisions (AP)

Desired Outcomes (DO)

DO 1

Efficient provision of infrastructure networks and services, renewable energy facilities and ancillary development in a manner that minimises hazard, is environmentally and culturally sensitive and that suitably manages adverse visual impacts on natural and rural landscapes and residential amenity.

Performance Outcomes and Deemed to Satisfy / Designated Performance Outcome Criteria

General

PO 1.1

Development located and designed to minimise hazard or nuisance to adjacent development and land uses.

DTS/DPF 1.1

None are applicable.

Visual Amenity

PO 2.1

The visual impact of above ground infrastructure networks and services, renewable energy facilities (excluding wind farms), energy storage facilities and ancillary development from townships, scenic routes and public roads is minimised and managed by:

- (a) utilising features of the natural landscape to obscure views where practicable;
- (b) siting development below ridgelines where practicable;
- (c) avoiding visually sensitive and significant landscapes;
- (d) using materials and finishes with low reflectivity and colours that complement the surroundings;
- (e) using existing vegetation to screen buildings; and
- (f) incorporating landscaping or landscaped mounding around the perimeter of a site and between adjacent allotments accommodating, or zoned to primarily accommodate sensitive receivers.

DTS/DPF 2.1

None are applicable.

PO 2.2

Substations, pumping stations, battery storage facilities, maintenance sheds and other ancillary structures incorporate vegetation buffers to reduce adverse visual impacts on adjacent land.

DTS/DPF 2.2

None are applicable.

PO 2.3

Surfaces exposed by earthworks associated with installation of storage facilities, pipework, penstock, substations and other ancillary plant are reinstated and revegetated to reduce adverse visual impacts on adjacent land.

DTS/DPF 2.3

None are applicable.

Rehabilitation

PO 3.1

Progressive rehabilitation (incorporating revegetation) of disturbed areas, ahead of or upon decommissioning of areas used for renewable energy facilities and transmission corridors.

DTS/DPF 3.1

None are applicable.

Hazard Management

PO 4.1

Infrastructure and renewable energy facilities and ancillary development located and operated to not adversely impact maritime or air transport safety, including the operation of ports, airfields and landing strips.

DTS/DPF 4.1

None are applicable.

PO 4.2

Facilities for energy generating, power storage and transmission separated from dwellings, tourist accommodation and frequently visited public places (such as viewing platforms / lookouts) to reduce risks to public safety from fire or equipment malfunction.

DTS/DPF 4.2

None are applicable.

PO 4.3

Bushfire hazard risk minimised for renewable energy facilities by providing appropriate access tracks, safety equipment, and water tanks and establishing cleared areas around substations, battery storage and operations compounds.

DTS/DPF 4.3

None are applicable.

Electricity Infrastructure and Battery Storage Facilities

PO 5.1

Electricity infrastructure located to minimise visual impacts through techniques including:

- (a) siting utilities and services:
 - (i) on areas already cleared of native vegetation; or
 - (ii) where there is minimal interference or disturbance to existing native vegetation or biodiversity; and
- (b) grouping utility buildings and structures with non-residential development, where practicable.

DTS/DPF 5.1

None are applicable.

PO 5.2

Electricity supply (excluding transmission lines) serving new development in urban areas and townships installed underground, excluding lines having a capacity exceeding or equal to 33kV.

DTS/DPF 5.2

None are applicable.

PO 5.3

Battery storage facilities co-located with substation infrastructure where practicable to minimise the development footprint and reduce environmental impacts.

DTS/DPF 5.3

None are applicable.

Telecommunication Facilities

PO 6.1

Where technically feasible, telecommunications facilities seek to reduce visual impact by incorporating techniques such as:

- (a) avoiding proliferation of facilities in a local area;
- (b) co-locating with other communications facilities;
- (c) locating antennae as close as practical to support structures ; and
- (d) screening using landscaping and existing vegetation, particularly for equipment shelters and huts.

DTS/DPF 6.1

None are applicable.

PO 6.2

Telecommunications facilities sited and designed to minimise visual impact having regard to:

- (a) the size, scale, context and characteristics of existing structures, heritage, landforms and vegetation so as to be compatible with the local environment;
- (b) incorporating the facility within an existing structure that may serve another purpose; and
- (c) using existing buildings and vegetation for screening.

DTS/DPF 6.2

None are applicable.

Renewable Energy Facilities

PO 7.1

Renewable energy facilities located as close as practicable to existing transmission infrastructure to facilitate connections and minimise environmental impacts as a result of extending transmission infrastructure.

DTS/DPF 7.1

None are applicable.

Renewable Energy Facilities (Wind Farm)

PO 8.1

Visual impact of wind turbine generators on the amenity of residential and tourist development reduced through appropriate separation.

DTS/DPF 8.1

Wind turbine generators are:

- (a) setback at least 1,200m from the base of the turbine to non-associated (non-stakeholder) dwellings and tourist accommodation;
- (b) setback at least 2,000m from the base of a turbine to any of the following zones:
 - i. Settlement Zone;
 - ii. Township Zone;

- iii. Rural Living Zone; or
- iv. Rural Neighbourhood Zone

with an additional 10m setback per additional metre over 150m overall turbine height (measured from the base of the turbine).

PO 8.2

The visual impact of wind turbine generators on natural landscapes managed by:

- (a) designing wind turbine generators to be uniform in colour, size and shape;
- (b) coordinating blade rotation and direction; and
- (c) mounting wind turbine generators on tubular towers as opposed to lattice towers.

DTS/DPF 8.2

None are applicable.

PO 8.3

Wind turbine generators and ancillary development minimise potential for bird and bat strike.

DTS/DPF 8.3

None are applicable.

PO 8.4

Wind turbine generators incorporate recognition systems or physical markers to minimise the risk to aircraft operations.

DTS/DPF 8.4

No Commonwealth air safety (CASA / ASA) or Defence requirement is applicable.

PO 8.5

Meteorological masts and guidewires identifiable to aircraft through the use of colour bands, marker balls, high visibility sleeves or flashing strobes.

DTS/DPF 8.5

None are applicable.

Renewable Energy Facilities (Solar Power)

PO 9.1

Solar power facilities generating 5MW or more are not located on land of high environmental, scenic or cultural value.

DTS/DPF 9.1

None are applicable.

PO 9.2

Solar power facilities allow for movement of wildlife by:

- (d) incorporating wildlife corridors and habitat refuges; and
- (e) avoiding the use of extensive security or perimeter fencing; or
- (f) incorporating fencing that enables the passage of small animals without unreasonably compromising the security of the facility.

DTS/DPF 9.2

None are applicable.

PO 9.3

Amenity impacts of solar power facilities minimised through separation from sensitive receivers.

DTS/DPF 9.3

Solar power facilities are setback at least:

- (a) 500 metres from conservation areas;
- (b) 100 metres from Township, Settlement, Rural Neighbourhood and Rural Living Zones; and
- (c) 30 metres from adjoining land.

PO 9.4

Solar power facilities incorporate landscaping within setbacks from adjacent road frontages and boundaries of adjacent allotments accommodating non-host dwellings.

DTS/DPF 9.4

None are applicable.

Hydropower / Pumped Hydropower Facilities

PO 10.1

Hydropower / pumped hydropower facility storage designed and operated to minimise the risk of storage dam failure.

DTS/DPF 10.1

None are applicable.

PO 10.2

Hydropower / pumped hydropower facility storage designed and operated to minimise water loss through increased evaporation or system leakage, with the incorporation of appropriate liners, dam covers, operational measures or detection systems.

DTS/DPF 10.2

None are applicable.

PO 10.3

Hydropower / pumped hydropower facilities on existing or former mine sites minimise environmental impacts from site contamination, including from mine operations or water sources subject to such processes, now or in the future.

DTS/DPF 10.3

None are applicable.

Water Supply

PO 11.1

Development connected to an appropriate water supply to meet the ongoing requirements of the intended use.

DTS/DPF 11.1

Development is connected, or will be connected, to a reticulated water scheme or mains water supply with the capacity to meet the on-going requirements of the development.

PO 11.2

Dwellings connected to a reticulated water scheme or mains water supply with the capacity to meet the requirements of the intended use. Where this is not available an appropriate rainwater tank or storage system for domestic use is provided.

DTS/DPF 11.2

A dwelling is connected, or will be connected, to a reticulated water scheme or mains water supply with the capacity to meet the requirements of the development. Where this is not available it is instead serviced by a rainwater tank or tanks capable of holding at least 50,000 litres of water which is:

- (a) exclusively for domestic use; and
- (b) connected to the roof drainage system of the dwelling.

Wastewater Services

PO 12.1

Development is connected to an approved common waste water disposal service with the capacity to meet the requirements of the intended use. Where this is not available an appropriate on-site service is provided to meet the on-going requirements of the intended use in accordance with the following:

- (a) it is wholly located and contained within the allotment of the development they will service.
- (b) in areas where there is a high risk of contamination of surface, ground, or marine water resources from on-site disposal of liquid wastes are to include disposal systems that minimise the risk of pollution to those water resources
- (c) ensures septic tank effluent drainage fields and other waste water disposal areas located away from watercourses and flood prone, sloping, saline or poorly drained land to minimise environmental harm.

DTS/DPF 12.1

Development is connected, or will be connected, to an approved common waste water disposal service with the capacity to meet the requirements of the development. Where this is not available it is instead serviced by an on-site waste water treatment system in accordance with the following:

- (a) is wholly located and contained within the allotment of development it will service; and
- (b) ensures no part of a septic tank effluent drainage field or any other waste water disposal system is located:
 - i. within 50m of a watercourse, bore, well or dam;
 - ii. on any land with a slope greater than 20% (1-in-5), or a depth to bedrock or seasonal or permanent water table less than 1.2m; and
 - iii. on land that is waterlogged, saline, part of a runway area or likely to be inundated by a 10% AEP flood event.

PO 12.2

Effluent drainage fields and other waste water disposal areas maintained to ensure the effective operation of waste systems and minimise risks to human health and environmental harm.

DTS/DPF 12.2

Development is not built on, or encroaches within, an area that is, or will be, required for a sewerage system or waste control system.

Temporary Facilities

PO 13.1

In rural and remote locations, development that is likely to generate significant waste material during construction, including packaging waste, makes provision for a temporary on-site waste storage enclosure to minimise the incidence of wind-blown litter.

DTS/DPF 13.1

A waste collection and disposal service will be used to dispose of the volume of waste and at a rate it is generated.

PO 13.2

Temporary facilities to support the establishment of renewable energy facilities (including borrow pits, concrete batching plants, laydown, storage, access roads and worker amenity areas) are sited and operated to minimise environmental impact.

DTS/DPF 13.2

None are applicable.

Intensive Animal Husbandry and Dairies

Assessment Provisions (AP)

Desired Outcome (DO)

DO 1

Development of intensive animal husbandry and dairies in locations that are protected from encroachment by sensitive receivers in a manner that minimises adverse effects on amenity and the environment.

Performance Outcomes and Deemed to Satisfy / Designated Performance Outcome Criteria

Siting and Designs

PO 1.1

Intensive animal husbandry, dairies and associated activities sited, designed, constructed and managed to not unreasonably impact on the environment or amenity of the locality.

DTS/DPF 1.1

None are applicable

PO 1.2

Intensive animal husbandry, dairies and associated activities sited, designed, constructed and managed to minimise the potential transmission of disease to other operations where animals are kept.

DTS/DPF 1.2

None are applicable

PO 1.3

Intensive animal husbandry and associated activities such as wastewater lagoons and liquid/solid waste disposal areas sited, designed, constructed and managed to not unreasonably impact on sensitive receivers in other ownership in terms of noise and air emissions.

DTS/DPF 1.3

None are applicable

PO 1.4

Dairies and associated activities such as wastewater lagoons and liquid/solid waste disposal areas sited, designed, constructed and managed to not unreasonably impact on sensitive receivers in other ownership in terms of noise and air emissions.

DTS/DPF 1.4

Dairies, associated wastewater lagoon(s) and liquid/solid waste storage and disposal facilities located 500m or more from the nearest sensitive receiver in other ownership.

PO 1.5

Lagoons for the storage or treatment of milking shed effluent adequately separated from roads to minimise impacts from odour on the general public.

DTS/DPF 1.5

Lagoons for the storage or treatment of milking shed effluent setback 20m or more from public roads.

Waste

PO 2.1

Storage of manure, used litter and other wastes (other than waste water lagoons) is sited, designed, constructed and managed to:

- (a) avoid attracting and harbouring vermin;
- (b) avoid polluting water resources; and
- (c) be located outside 1% AEP flood event areas.

DTS/DPF 2.1

None are applicable

Soil and Water Protection

PO 3.1

To avoid environmental harm and adverse effects on water resources, intensive animal husbandry operations appropriately setback from:

- (a) public water supply reservoirs;
- (b) major watercourses (third order or higher stream); and
- (c) any other watercourse, bore or well used for domestic or stock water supplies.

DTS/DPF 3.1

Intensive animal husbandry operations are setback:

- (a) 800m or more from a public water supply reservoir;
- (b) 200m or more from a major watercourse (third order or higher stream); and
- (c) 100m or more from any other watercourse, bore or well used for domestic or stock water supplies.

PO 3.2

Intensive animal husbandry operations and dairies incorporate appropriately designed effluent and run-off facilities:

- (a) that have sufficient capacity to hold effluent and runoff from the operations on site; and
- (b) ensure that effluent does not infiltrate and pollute groundwater, soil or other water resources.

DTS/DPF 3.2

None are applicable

Land Division in Urban Areas

Assessment Provisions (AP)

Desired Outcome (DO)

DO 1

Land division that:

- (c) creates allotments having appropriate dimensions and shape for intended use;
- (d) allows efficient provision of new infrastructure and optimum use of existing underutilised infrastructure;
- (e) integrates and allocates adequate and suitable land for the preservation of site features of value including significant vegetation, watercourses, water bodies and other environmental features;
- (f) supports energy efficiency in building orientation;
- (g) creates a compact urban form that supports active travel, walkability and the use of public transport; and
- (h) avoids areas of high natural hazard risk.

Performance Outcomes and Deemed to Satisfy / Designated Performance Outcome Criteria

ALL LAND DIVISION

Allotment configuration

PO 1.1

Land division creates allotments suitable for their intended use taking into account physical characteristics of the land, preservation of environmental and cultural features of value and the prevailing context of the locality.

DTS/DPF 1.1

Land division for the:

- (a) minor adjustment of allotment boundaries to remove an anomaly in existing boundaries with respect to the location of existing buildings or structures where no additional allotments are created; or
- (b) creation of a single additional allotment for residential purposes where:
 - i. the allotment will contain a single lawfully existing dwelling or an approval for a single dwelling exists and is operative;
 - ii. access is provided via a lawfully existing driveway or access point or an access point for which approval under the Local Government Act exists and is operative; and
 - iii. the resulting allotment achieves any minimum site area and frontage width specified by the relevant zone or a relevant Technical and Numeric Variation Overlays.

Design and Layout

PO 2.1

Land division results in a pattern of development that minimises the likelihood of future earthworks and retaining walls

DTS 2.1

None are applicable.

PO 2.2

Land division enables appropriate treatment of the interface between potentially conflicting land uses and/or zones.

DTS 2.2

None are applicable.

PO 2.3

Land division maximises the number of allotments that face public open space and public streets.

DTS 2.3

None are applicable.

PO 2.4

Land division integrated with site features, adjacent land uses, the existing transport network and available infrastructure.

DTS 2.4

None are applicable.

PO 2.5

Development and infrastructure provided and staged in a manner that supports an orderly and economic provision of land, infrastructure and services.

DTS 2.5

None are applicable

PO 2.6

Land division results in watercourses being retained within open space and land subject to flooding free from development.

DTS 2.6

None are applicable.

PO 2.7

Land division results in street patterns that are legible and connected to the surrounding street network.

DTS 2.7

None are applicable.

PO 2.8

Land division is designed to allocate adequate and suitable land for the preservation of existing vegetation of value including native vegetation, regulated and significant trees.

DTS 2.8

None are applicable.

Roads and Access

PO 3.1

Land division provides allotments with access to a public road.

DTS 3.1

None are applicable.

PO 3.2

Street patterns and intersections designed to enable the safe and efficient movement of pedestrian, cycle and vehicular traffic.

DTS 3.2

None are applicable.

PO 3.3

Land division does not impede access to publicly owned open space and recreation facilities.

DTS 3.3

None are applicable.

PO 3.4

Road reserves provide for safe and convenient movement and parking of projected volumes of vehicles, and allow for the efficient movement of service and emergency vehicles.

DTS 3.4

None are applicable.

PO 3.5

Road reserves provide for footpaths, cycle lanes and shared-use paths, and accommodate street tree planting, landscaping and street furniture.

DTS 3.5

None are applicable.

PO 3.6

Road reserves accommodate stormwater drainage and public utilities.

DTS 3.6

None are applicable.

PO 3.7

Road reserves provide unobstructed vehicular access and egress to and from individual allotments and sites.

DTS 3.7

None are applicable.

PO 3.8

Street patterns and intersections designed to enable the safe and efficient movement of pedestrian, cycle and vehicular traffic.

DTS 3.8

None are applicable.

PO 3.9

Roads, open space and thoroughfares provided establish safe and convenient linkages to the surrounding open space and transport network.

DTS 3.9

None are applicable.

PO 3.10

Public streets include tree planting to provide shade and enhance the amenity of streetscapes.

DTS 3.10

None are applicable.

PO 3.11

Local streets designed to create low-speed environments that are safe for cyclists and pedestrians.

DTS 3.11

None are applicable.

Infrastructure**PO 4.1**

Land division incorporates public utility services within road reserves or within dedicated easements.

DTS 4.1

None are applicable.

PO 4.2

Waste water, sewage and other effluent is capable of being disposed of from each allotment without unreasonable risk to public health or the environment.

DTS/DPF 4.2

Each allotment can be connected to any of the following:

- (a) a waste water treatment plant that has the hydraulic volume and pollutant load treatment and disposal capacity for the maximum predicted wastewater volume generated by subsequent development of the proposed allotments; or
- (b) a form of on-site waste water treatment and disposal that meets relevant public health and environmental standards.

PO 4.3

Septic tank effluent drainage fields and other waste water disposal areas maintained to ensure the effective operation of waste systems and minimise risks to human health and environmental harm.

DTS / DPF 4.3

Development is not built on, or encroaches within, an area that is, or will be, required for a sewerage system or waste control system.

PO 4.4

Constructed wetland systems, including associated detention and retention basins, sited and designed to ensure public health and safety is protected including by minimising potential public health risks arising from the breeding of mosquitoes.

DTS 4.4

None are applicable.

PO 4.5

Constructed wetland systems, including associated detention and retention basins, sited and designed to allow sediments to settle prior to discharge into watercourses or the marine environment.

DTS 4.5

None are applicable.

PO 4.6

Constructed wetland systems, including associated detention and retention basins, sited and designed to function as a landscape feature.

DTS 4.6

None are applicable.

MINOR LAND DIVISION (UNDER 20 ALLOTMENTS)

Open Space

PO 5.1

Land division proposing an additional allotment under 1 hectare in area provides or supports the provision of open space.

DTS 5.1

None are applicable.

PO 5.2

Land division creating 5-19 non-residential allotments includes a stormwater management system designed to mitigate peak flows and manage the rate and duration of stormwater discharges from the site to ensure the carrying capacities of downstream systems are not overloaded.

DTS 5.2

Land division creating 5-19 non-residential allotments is accompanied by an approved Stormwater Management Plan and manages up to and including the 100 –year ARI flood event (1% AEP) to avoid flooding of buildings and:

- (a) maintain
 - i. a pre-development peak flow rate from the site based upon a 0.35 runoff coefficient for the 5-year ARI (18.1% AEP) 30 minute storm; and
 - ii. the stormwater runoff time to peak to match that of the pre-development; or
- (b) capture and retain the difference in pre-development runoff volume (based upon a 0.35 runoff coefficient) vs post development runoff volume from the site for a 5-year ARI (18.1% AEP) 30 minute storm; and
- (c) manage site generated stormwater runoff up to and including the 100 –year ARI flood event (1% AEP) to avoid flooding of buildings.

Solar Orientation

PO 6.1

Land division for residential purposes facilitates solar access for energy efficiency through allotment orientation.

DTS 6.1

None are applicable.

Water Sensitive Design

PO 7.1

Land division creating 5-19 allotments includes stormwater management systems that minimise the discharge of sediment, suspended solids, organic matter, nutrients, bacteria, litter and other contaminants to the stormwater system, watercourses or other water bodies.

DTS 7.1

Land division creating 5-19 allotments is accompanied by an approved Stormwater Management Plan and achieves the following stormwater runoff outcomes:

- (a) 80 per cent reduction in average annual total suspended solids;
- (b) 60 per cent reduction in average annual total phosphorus;
- (c) 45 per cent reduction in average annual total nitrogen.

PO 7.2

Land division creating 5-19 non-residential allotments includes a stormwater management system designed to mitigate peak flows and manage the rate and duration of stormwater discharges from the site to ensure the carrying capacities of downstream systems are not overloaded.

DTS / DPF 7.2

Land division creating 5-19 non-residential allotments includes a storm water management system designed to:

- (a) maintain a pre-development peak flow rate from the site based upon a 0.35 runoff coefficient for the 20-year ARI (5% AEP) 30 minute storm, unless a lower performance measure is specified in an approved catchment based Stormwater Management Plan;

- (b) maintain the stormwater runoff time to peak to match that of the pre-development; and
- (c) manage site generated stormwater runoff up to and including the 100 –year ARI flood event (1% AEP).

MAJOR LAND DIVISION (20+ ALLOTMENTS)

Open Space

PO 8.1

Land division allocates or retains, evenly distributed, high quality areas of open space to improve residential amenity and provide urban heat amelioration.

DTS 8.1

None are applicable

PO 8.2

Land allocated for open space is suitable for intended active and passive recreational use considering gradient and potential for inundation.

DTS / DPF 8.2

Where provided, no more than 20% of open space:

- (a) has a slope in excess of 1 in 4; and
- (b) is comprised of watercourses, wetlands or detention basins.

PO 8.3

Land allocated for active recreation is of a size and has dimensions capable of accommodating a range of active recreational activities.

DTS 8.3

None are applicable.

Water Sensitive Design

PO 9.1

Land division creating 20 or more residential allotments includes a stormwater management system designed to mitigate peak flows and manage the rate and duration of stormwater discharges from the site to ensure the carrying capacities of downstream systems are not overloaded.

DTS/DPF 9.1

Land division creating 20 or more residential allotments is accompanied by an approved Stormwater Management Plan and manages up to and including the 100 –year ARI flood event (1% AEP) to avoid flooding of buildings and:

- (a) maintains pre-development peak 5-year ARI (18.1% AEP) flow rate from the site, and maintains the time to peak to match that of the pre-development; or
- (b) captures and retains the difference in pre-development volume vs post development volume from the site for a 5-year ARI (18.1% AEP) 30 minute storm; or where there is no adequate local drainage scheme to connect to, captures and retains post development volume from the site for a 5 year ARI (18.1% AEP) 30 minute storm.

PO 9.2

Land division creating 20 or more non- residential allotments includes a stormwater management system designed to mitigate peak flows and manage the rate and duration of stormwater discharges from the site to ensure the carrying capacities of downstream systems are not overloaded.

DTS/DPF 9.2

Land division creating 20 or more non- residential allotments is accompanied by an approved Stormwater Management Plan and manages up to and including the 100 –year ARI flood event (1% AEP) to avoid flooding of buildings and:

- (a) maintains pre-development peak 20-year ARI (5% AEP) flow rate from the site and, maintains the time to peak to match that of the pre-development; or
- (b) captures and retains the difference in pre-development volume vs post development volume from the site for a 20-year ARI (5% AEP) 30 minute storm; where there is no adequate local drainage scheme to connect to, captures and retains post development volume from the site for a 20 year ARI (5% AEP) 30 minute storm.

PO 9.3

Land division creating 20 or more allotments includes stormwater management systems that minimise the discharge of sediment, suspended solids, organic matter, nutrients, bacteria, litter and other contaminants to the stormwater system, watercourses or other water bodies

DTS 9.3

Land division creating 20 or more allotments is accompanied by an approved Stormwater Management Plan and achieves the following stormwater runoff outcomes:

- (a) 80 per cent reduction in average annual total suspended solids;
- (b) 60 per cent reduction in average annual total phosphorus;
- (c) 45 per cent reduction in average annual total nitrogen.

Solar Orientation

PO 10.1

Land division for residential purposes facilitates solar access for energy efficient through allotment orientation and allotment dimensions.

DTS/DPF 10.1

Land division results in:

- (a) at least 80% of allotments oriented so that their long axis conforms with figure 10.1:

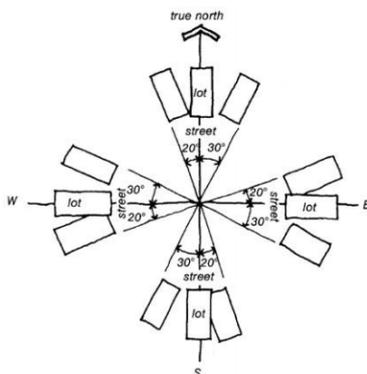

- (b) 80% of allotments with an east-west orientation having a minimum frontage of 15m
- (c) no more than 20% of allotments are located on the south side of east-west oriented streets.

Land Division in Rural Areas

Assessment Provisions (AP)

Desired Outcome (DO)
<p>DO 1</p> <p>Land division that:</p> <ul style="list-style-type: none"> (a) creates allotments having appropriate dimensions and shape for intended use; (b) allows efficient provision of new infrastructure and optimum use of existing underutilised infrastructure; (c) integrates and allocates adequate and suitable land for the preservation of site features of value including significant vegetation, watercourses, water bodies and other environmental features; and (d) supports energy efficiency in building orientation; (e) creates a compact urban form that supports active travel, walkability and the use of public transport; and (f) avoids areas of high natural hazard risk.

<p>Performance Outcomes (PO)</p>	<ul style="list-style-type: none"> • Deemed to Satisfy Criteria (DTS) (required for development to be classified as Deemed-to-Satisfy) • Designated Performance Feature (DPF) (used for development to be assessed on its merits against the applicable policies of the Planning and Design Code)
---	---

ALL LAND DIVISION

Allotment configuration

<p>PO 1.1</p> <p>Land division creates allotments suitable for their intended use taking into account physical characteristics of the land, preservation of environmental and cultural features of value and the prevailing context of the locality.</p>	<p>DTS/DPF 1.1</p> <p>Land division for the:</p> <ul style="list-style-type: none"> (a) minor adjustment of allotment boundaries to remove an anomaly in existing boundaries with respect to the location of existing buildings or structures where no additional allotments are created; or (b) Creation of a single additional allotment for residential purposes where: <ul style="list-style-type: none"> (i) the allotment will contain a single lawfully existing dwelling or an approval for a single dwelling exists and is operative;
---	---

Performance Outcomes (PO)	<ul style="list-style-type: none"> • Deemed to Satisfy Criteria (DTS) (required for development to be classified as Deemed-to-Satisfy) • Designated Performance Feature (DPF) (used for development to be assessed on its merits against the applicable policies of the Planning and Design Code)
	<p>(ii) access is provided via a lawfully existing driveway or access point or an access point for which approval under the Local Government Act exists and is operative; and</p> <p>(iii) the resulting allotment achieves any minimum site area and frontage width specified by the relevant zone or a relevant Technical and Numerical Variation Overlays.</p>
<p>PO 1.2</p> <p>Land division creates allotments suitable for their intended use.</p>	<p>DTS/DPF 1.1</p> <p>Division of land that reflects the site or allotment boundaries on a valid development authorisation for Development Plan Consent under the <i>Development Act 1993</i> or Planning Consent under the <i>Planning, Development and Infrastructure Act 2016</i>.</p>
Design and Layout	
<p>PO 2.1</p> <p>Land division results in a pattern of development that minimises the likelihood of future earthworks and retaining walls</p>	<p>None are applicable.</p>
<p>PO 2.2</p> <p>Land division enables appropriate treatment of the interface between potentially conflicting land uses and/or zones.</p>	<p>None are applicable.</p>
<p>PO 2.3</p> <p>Land division maximises the number of allotments that face public open space and public streets.</p>	<p>None are applicable.</p>
<p>PO 2.4</p>	<p>None are applicable.</p>

Performance Outcomes (PO)	<ul style="list-style-type: none"> • Deemed to Satisfy Criteria (DTS) (required for development to be classified as Deemed-to-Satisfy) • Designated Performance Feature (DPF) (used for development to be assessed on its merits against the applicable policies of the Planning and Design Code)
Land division integrated with site features, adjacent land uses, the existing transport network and available infrastructure.	
<p>PO 2.5</p> <p>Development and infrastructure provided and staged in a manner that supports an orderly and economic provision of land, infrastructure and services.</p>	None are applicable
<p>PO 2.6</p> <p>Land division results in watercourses being retained within open space and land subject to flooding free from development.</p>	None are applicable.
<p>PO 2.7</p> <p>Land division results in street patterns that are legible and connected to the surrounding street network.</p>	None are applicable.
Roads and Access	
<p>PO 3.1</p> <p>Land division provides allotments with access to a public road.</p>	None are applicable.
<p>PO 3.2</p> <p>Street patterns and intersections designed to enable the safe and efficient movement of pedestrian, cycle and vehicular traffic.</p>	None are applicable.
<p>PO 3.3</p> <p>Land division does not impede access to publicly owned open space and recreation facilities.</p>	None are applicable.

Performance Outcomes (PO)	<ul style="list-style-type: none"> • Deemed to Satisfy Criteria (DTS) (required for development to be classified as Deemed-to-Satisfy) • Designated Performance Feature (DPF) (used for development to be assessed on its merits against the applicable policies of the Planning and Design Code)
<p>PO 3.4</p> <p>Road reserves provide for safe and convenient movement and parking of projected volumes of vehicles, and allow for the efficient movement of service and emergency vehicles.</p>	<p>None are applicable.</p>
<p>PO 3.5</p> <p>Road reserves provide for footpaths, cycle lanes and shared-use paths, and accommodate street tree planting, landscaping and street furniture.</p>	<p>None are applicable.</p>
<p>PO 3.6</p> <p>Road reserves accommodate stormwater drainage and public utilities.</p>	<p>None are applicable.</p>
<p>PO 3.7</p> <p>Road reserves provide unobstructed vehicular access and egress to and from individual allotments and sites.</p>	<p>None are applicable.</p>
<p>PO 3.8</p> <p>Street patterns and intersections designed to enable the safe and efficient movement of pedestrian, cycle and vehicular traffic.</p>	<p>None are applicable.</p>
<p>PO 3.9</p> <p>Roads, open space and thoroughfares provided establish safe and convenient linkages to the surrounding open space and transport network.</p>	<p>None are applicable.</p>
<p>PO 3.10</p> <p>Public streets include tree planting to provide shade and enhance the amenity of streetscapes.</p>	<p>None are applicable.</p>

Performance Outcomes (PO)	<ul style="list-style-type: none"> • Deemed to Satisfy Criteria (DTS) (required for development to be classified as Deemed-to-Satisfy) • Designated Performance Feature (DPF) (used for development to be assessed on its merits against the applicable policies of the Planning and Design Code)
<p>PO 3.11</p> <p>Local streets designed to create low-speed environments that are safe for cyclists and pedestrians.</p>	<p>None are applicable.</p>
<p>Infrastructure</p>	
<p>PO 4.1</p> <p>Land division incorporates public utility services within road reserves or within dedicated easements.</p>	<p>None are applicable.</p>
<p>PO 4.2</p> <p>Waste water, sewage and other effluent is capable of being disposed of from each allotment without unreasonable risk to public health or the environment.</p>	<p>DTS/DPF 4.2</p> <p>Each allotment can be connected to any of the following:</p> <ul style="list-style-type: none"> (a) a waste water treatment plant that has the hydraulic volume and pollutant load treatment and disposal capacity for the maximum predicted wastewater volume generated by subsequent development of the proposed allotments; or (b) a form of on-site waste water treatment and disposal that meets relevant public health and environmental standards.
<p>PO 4.3</p> <p>Septic tank effluent drainage fields and other waste water disposal areas maintained to ensure the effective operation of waste systems and minimise risks to human health and environmental harm.</p>	<p>DTS/DPF 4.3</p> <p>Development is not built on, or encroaches within, an area that is, or will be, required for a sewerage system or waste control system.</p>

Performance Outcomes (PO)	<ul style="list-style-type: none"> • Deemed to Satisfy Criteria (DTS) (required for development to be classified as Deemed-to-Satisfy) • Designated Performance Feature (DPF) (used for development to be assessed on its merits against the applicable policies of the Planning and Design Code)
<p>PO 4.4</p> <p>Constructed wetland systems, including associated detention and retention basins, sited and designed to ensure public health and safety is protected including by minimising potential public health risks arising from the breeding of mosquitoes.</p>	None are applicable.
<p>PO 4.5</p> <p>Constructed wetland systems, including associated detention and retention basins, sited and designed to allow sediments to settle prior to discharge into watercourses or the marine environment.</p>	None are applicable.
<p>PO 4.6</p> <p>Constructed wetland systems, including associated detention and retention basins, sited and designed to function as a landscape feature.</p>	None are applicable.
MINOR LAND DIVISION (UNDER 20 ALLOTMENTS)	
Open Space	
<p>PO 5.1</p> <p>Land division proposing an additional allotment under 1 hectare in area provides or supports the provision of open space.</p>	None are applicable.
Solar Orientation	
<p>PO 6.1</p> <p>Land division for residential purposes facilitates solar access for energy efficiency through allotment orientation.</p>	None are applicable.

Performance Outcomes (PO)	<ul style="list-style-type: none"> • Deemed to Satisfy Criteria (DTS) (required for development to be classified as Deemed-to-Satisfy) • Designated Performance Feature (DPF) (used for development to be assessed on its merits against the applicable policies of the Planning and Design Code)
----------------------------------	---

Water Sensitive Design

<p>PO 7.1</p> <p>Land division creating 5-19 allotments includes stormwater management systems that minimise the discharge of sediment, suspended solids, organic matter, nutrients, bacteria, litter and other contaminants to the stormwater system, watercourses or other water bodies.</p>	<p>DTS 7.1</p> <p>Land division creating 5-19 allotments is accompanied by an approved <i>Stormwater Management Plan</i> and achieves the following stormwater runoff outcomes:</p> <ul style="list-style-type: none"> (a) 80 per cent reduction in average annual total suspended solids; (b) 60 per cent reduction in average annual total phosphorus; (c) 45 per cent reduction in average annual total nitrogen.
<p>PO 7.2</p> <p>Land division creating 5-19 non-residential allotments includes a stormwater management system designed to mitigate peak flows and manage the rate and duration of stormwater discharges from the site to ensure the carrying capacities of downstream systems are not overloaded.</p>	<p>DTS / DPF 7.2</p> <p>Land division creating 5-19 non-residential allotments includes a storm water management system designed to:</p> <ul style="list-style-type: none"> (a) maintain a pre-development peak flow rate from the site based upon a 0.35 runoff coefficient for the 20-year ARI (5% AEP) 30 minute storm, unless a lower performance measure is specified in an approved catchment based Stormwater Management Plan; (b) maintain the stormwater runoff time to peak to match that of the pre-development; and (a) manage site generated stormwater runoff up to and including the 100 –year ARI flood event (1% AEP).

MAJOR LAND DIVISION (20+ ALLOTMENTS)

Open Space

<p>PO 8.1</p>	<p>None are applicable.</p>
----------------------	-----------------------------

Performance Outcomes (PO)	<ul style="list-style-type: none"> • Deemed to Satisfy Criteria (DTS) (required for development to be classified as Deemed-to-Satisfy) • Designated Performance Feature (DPF) (used for development to be assessed on its merits against the applicable policies of the Planning and Design Code)
Land division allocates or retains, evenly distributed, high quality areas of open space to improve residential amenity and provide urban heat amelioration.	
<p>PO 8.2</p> <p>Land allocated for open space is suitable for intended active and passive recreational use considering gradient and potential for inundation.</p>	<p>DTS / DPF 8.2</p> <p>Where provided, no more than 20% of open space:</p> <ul style="list-style-type: none"> (a) has a slope in excess of 1 in 4; and (b) is comprised of watercourses, wetlands or detention basins.
<p>PO 8.3</p> <p>Land allocated for active recreation is of a size and has dimensions capable of accommodating a range of active recreational activities.</p>	None are applicable.
Water Sensitive Design	
<p>PO 9.1</p> <p>Land division creating 20 or more residential allotments includes a stormwater management system designed to mitigate peak flows and manage the rate and duration of stormwater discharges from the site to ensure the carrying capacities of downstream systems are not overloaded.</p>	<p>DTS/DPF 9.1</p> <p>Land division creating 20 or more residential allotments is accompanied by an approved <i>Stormwater Management Plan</i> and manages up to and including the 100 –year ARI flood event (1% AEP) to avoid flooding of buildings and:</p> <ul style="list-style-type: none"> (a) maintains pre-development peak 5-year ARI (18.1% AEP) flow rate from the site, and maintains the time to peak to match that of the pre-development; or (d) captures and retains the difference in pre-development volume vs post development volume from the site for a 5-year ARI (18.1% AEP) 30 minute storm; or where there is no adequate local drainage scheme to connect to, captures and retains post development volume from the site for a 5 year ARI (18.1% AEP) 30 minute storm.

Performance Outcomes (PO)	<ul style="list-style-type: none"> • Deemed to Satisfy Criteria (DTS) (required for development to be classified as Deemed-to-Satisfy) • Designated Performance Feature (DPF) (used for development to be assessed on its merits against the applicable policies of the Planning and Design Code)
<p>PO 9.2</p> <p>Land division creating 20 or more non-residential allotments includes a stormwater management system designed to mitigate peak flows and manage the rate and duration of stormwater discharges from the site to ensure the carrying capacities of downstream systems are not overloaded</p>	<p>DTS/DPF 9.2</p> <p>Land division creating 20 or more non-residential allotments is accompanied by an approved <i>Stormwater Management Plan</i> and manages up to and including the 100 –year ARI flood event (1% AEP) to avoid flooding of buildings and:</p> <ul style="list-style-type: none"> (a) maintains pre-development peak 20-year ARI (5% AEP) flow rate from the site and, maintains the time to peak to match that of the pre-development; or (b) captures and retains the difference in pre-development volume vs post development volume from the site for a 20-year ARI (5% AEP) 30 minute storm; where there is no adequate local drainage scheme to connect to, captures and retains post development volume from the site for a 20 year ARI (5% AEP) 30 minute storm.
<p>PO 9.3</p> <p>Land division creating 20 or more allotments includes stormwater management systems that minimise the discharge of sediment, suspended solids, organic matter, nutrients, bacteria, litter and other contaminants to the stormwater system, watercourses or other water bodies</p>	<p>DTS 9.2</p> <p>Land division creating 20 or more allotments is accompanied by an approved <i>Stormwater Management Plan</i> and achieves the following stormwater runoff outcomes:</p> <ul style="list-style-type: none"> (a) 80 per cent reduction in average annual total suspended solids (b) 60 per cent reduction in average annual total phosphorus (c) 45 per cent reduction in average annual total nitrogen
Solar Orientation	
<p>PO 10.1</p> <p>Land division creating 20 or more allotments for residential purposes facilitates solar</p>	<p>DTS/DPF 10.1</p> <p>Land division results in:</p>

Performance Outcomes (PO)

- **Deemed to Satisfy Criteria (DTS)**
(required for development to be classified as Deemed-to-Satisfy)
- **Designated Performance Feature (DPF)**
(used for development to be assessed on its merits against the applicable policies of the Planning and Design Code)

access for energy efficient through allotment orientation and allotment dimensions.

- (a) at least 80% of allotments oriented so that their long axis conforms with figure 10.1:

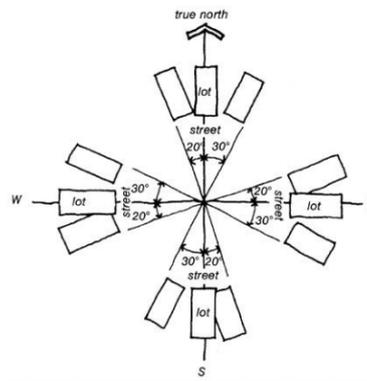

- (b) 80% of allotments with an east-west orientation having a minimum frontage of 15m
- (c) no more than 20% of allotments are located on the south side of east-west oriented streets. no more than 20% of allotments are located on the south side of east-west oriented streets.

Marinas and On-Water Structures

Assessment Provisions (AP)

Desired Outcome (DO)

DO 1

Marinas and on-water structures located and designed to minimise impairment of commercial, recreational and navigational activities and adverse impacts on the environment.

Performance Outcomes and Deemed to Satisfy / Designated Performance Outcome Criteria

Navigation and Safety

PO 1.1

Safe public access is provided or maintained to the waterfront, public infrastructure and recreation areas.

DTS/DPF 1.1

None are applicable

PO 1.2

The operation of wharves not impaired by marinas and on-water structures.

DTS/DPF 1.2

None are applicable

PO 1.3

Navigation and access channels not impaired by marinas and on-water structures.

DTS/DPF 1.3

None are applicable

PO 1.4

Commercial shipping lanes not impaired by marinas and on-water structures.

DTS/DPF 1.4

Marinas and on-water structures are setback 250m or more from commercial shipping lanes.

PO 1.5

Marinas and on-water structures located to avoid interfering with the operation or function of a water supply pumping station.

DTS/DPF 1.5

On-water structures are setback:

- (a) 3km or more from upstream water supply pumping station take-off points; and
- (b) 500m or more from downstream water supply pumping station take-off points.

PO 1.6

Maintenance of on-water infrastructure, including revetment walls, not impaired by marinas and on-water structures.

DTS/DPF 1.6

None are applicable

Environmental Protection

PO 2.1

Development sited and designed to facilitate water circulation and exchange.

DTS/DPF 2.1

None are applicable

Open Space and Recreation

Assessment Provisions (AP)

Desired Outcome (DO)

DO 1

Pleasant, functional and accessible open space and recreation facilities provided for active and passive recreation.

Performance Outcomes and Deemed to Satisfy / Designated Performance Outcome Criteria

Land Use and Intensity

PO 1.1

Recreation facilities compatible with surrounding land use and activity.

DTS/DPF 1.1

None are applicable

Design and Siting

PO 2.1

Open space and recreation facilities address adjacent public roads to optimise pedestrian access and visibility.

DTS/DPF 2.1

None are applicable

PO 2.2

Open space and recreation facilities incorporate park furniture, shaded areas and resting places to enhance pedestrian comfort.

DTS/DPF 2.2

None are applicable

PO 2.3

Open space and recreation facilities link habitats, wildlife corridors and existing open spaces and recreation facilities.

DTS/DPF 2.3

None are applicable

Pedestrians and Cyclists

PO 3.1

Open space incorporates:

- (a) pedestrian and cycle linkages to other open spaces, centres, schools and public transport nodes;
- (b) safe crossing points where pedestrian routes intersect the road network; and
- (c) easily identified access points.

DTS/DPF 3.1

None are applicable.

Usability

PO 4.1

Land allocated for open space is suitable for intended active and passive recreational use considering gradient and potential for inundation.

DTS/DPF 4.1

No more than 20% of the open space:

- (a) has a slope in excess of 1 in 4; and
- (b) is comprised of watercourses, wetlands or detention basins.

Safety and Security

PO 5.1

Open space is overlooked by housing, commercial or other development to provide casual surveillance where possible.

DTS/DPF 5.1

None are applicable.

PO 5.2

Play equipment is located where it can be casually observed by nearby residents and users.

DTS/DPF 5.2

None are applicable.

PO 5.3

Landscaping provided in open space and recreation facilities maximises opportunities for casual surveillance throughout the park.

DTS/DPF 5.3

None are applicable.

PO 5.4

Fenced parks and playgrounds have more than one entrance or exit to minimise potential entrapment.

DTS/DPF 5.4

None are applicable.

PO 5.5

Adequate lighting provided around toilets, telephones, seating, litter bins, bicycle storage, car parks and other such facilities.

DTS/DPF 5.5

None are applicable.

PO 5.6

Pedestrian and bicycle movement after dark focused along clearly defined, adequately lit routes with observable entries and exits.

DTS/DPF 5.6

None are applicable.

Signage

PO 6.1

Signage provided at entrances to and within public open space to provide clear orientation to major points of interest such as the location of public toilets, telephones, safe routes, park activities and the like.

DTS/DPF 6.1

None are applicable.

Buildings and Structures

PO 7.1

Buildings and car parking areas in open space areas are designed, located and of a scale to be unobtrusive.

DTS/DPF 7.1

None are applicable.

PO 7.2

Buildings and structures in open space are clustered where practical to ensure that the majority of the site remains open.

DTS/DPF 7.2

None are applicable.

PO 7.3

Development in open space is constructed to minimise the extent of hard paved areas.

DTS/DPF 7.3

None are applicable.

PO 7.4

Development that abuts or includes a coastal reserve or Crown land used for scenic, conservation or recreational purposes is located and designed to have regard to the purpose, management and amenity of the reserve.

DTS/DPF 7.4

None are applicable.

Landscaping

PO 8.1

Open space and recreation facilities provide for the planting and retention of large trees and vegetation.

DTS/DPF 8.1

None are applicable.

PO 8.2

Landscaping in open space and recreation facilities provides shade and windbreaks:

- (a) along cyclist and pedestrian routes
- (b) around picnic and barbecue areas; and
- (c) in car parking areas.

DTS/DPF 8.2

None are applicable.

PO 8.3

Landscaping in open space facilitates habitat for local fauna and facilitates biodiversity.

DTS/DPF 8.3

None are applicable.

Resource Extraction

Assessment Provisions (AP)

Desired Outcome (DO)

DO 1

Resource extraction activities developed in a manner that minimises human and environmental impacts.

Performance Outcomes and Deemed to Satisfy / Designated Performance Outcome Criteria

Land Use and Intensity

PO 1.1

Resource extraction activities minimise landscape damage and provide for the progressive reclamation and betterment of disturbed areas.

DTS/DPF 1.1

None are applicable.

PO 1.2

Resource extraction activities avoid damage to cultural sites or artefacts.

DTS/DPF 1.2

None are applicable.

Water Quality

PO 2.1

Stormwater and/or waste water from resource extraction activities is diverted into appropriately sized treatment and retention systems to enable reuse on-site.

DTS/DPF 2.1

None are applicable.

Separation Treatments, Buffers and Landscaping

PO 3.1

Resource extraction activities minimise adverse impacts upon sensitive receivers through incorporation of separation distances and/or mounding/vegetation.

DTS/DPF 3.1

None are applicable.

PO 3.2

Resource extraction activities are screened from view from adjacent land by perimeter landscaping and/or mounding.

DTS/DPF 3.2

None are applicable.

Site Contamination

Assessment Provisions (AP)

Desired Outcome (DO)

DO 1

Protection of human health and the environment wherever site contamination has been identified or is suspected to have occurred.

Performance Outcomes and Deemed to Satisfy / Designated Performance Outcome Criteria

PO 1.1

Ensure land is suitable for sensitive use in circumstances where it is, or may have been, subject to site contamination as a result of previously established uses of land or activities in the vicinity of the land.

DTS/DPF 1.1

Development:

- (a) does not incorporate a change of use of land;
- (b) incorporates a change of use of land that is not a more sensitive use of land than previously established uses of the land;
- (c) in respect of which the applicant is able to furnish, or the relevant authority is in possession of, a site contamination audit report less than 5 years old under Part 10A of the Environment Protection Act 1993 to the effect:
 - i. that site contamination does not exist (or no longer exists) at the land; or
 - ii. that any site contamination at the land has been cleared or addressed to the extent necessary to enable the land to be suitable for sensitive use; or
- (d) the allotment was the subject of consent granted under the Development Act 1993 or the Planning Development and Infrastructure Act 2016 on or after 1 September 2009 in relation the division of the land.

Tourism Development

Assessment Provisions (AP)

Desired Outcomes (DO)

DO 1

Tourism development in suitable locations that caters to the needs of visitors.

Performance Outcomes and Deemed to Satisfy / Designated Performance Outcome Criteria

General

PO 1.1

Tourism development complements and contributes to local, natural, cultural or historical context.

DTS/DPF 1.1

None are applicable.

PO 1.2

Tourism development comprising multiple accommodation units (including any facilities and activities for use by guests and visitors) clustered to minimise environmental and contextual impact.

DTS/DPF 1.2

None are applicable.

Caravan and Tourist Parks

PO 2.1

Potential conflicts between long-term residents and short-term tourists minimised through suitable siting and design measures.

DTS/DPF 2.1

None are applicable.

PO 2.2

Occupants are provided privacy and amenity through landscaping and fencing.

DTS/DPF 2.2

None are applicable.

PO 2.3

Communal open space and centrally located recreation facilities provided for guests and visitors.

DTS/DPF 2.3

12.5% or more of a caravan park comprises clearly defined communal open space, landscaped areas and areas for recreation.

PO 2.4

Perimeter landscaping is used to enhance the amenity of the locality.

DTS/DPF 2.4

None are applicable.

PO 2.5

Amenity blocks (showers, toilets, laundry and kitchen facilities) sufficient to serve peak population.

DTS/DPF 2.5

None are applicable.

PO 2.6

Long-term occupation does not displace tourist accommodation, particularly in important tourist destinations such as coastal and riverside locations.

DTS/DPF 2.6

None are applicable.

Transport, Access and Parking

Assessment Provisions (AP)

Desired Outcomes (DO)

DO 1

A comprehensive, integrated and connected transport system that is safe, sustainable, efficient, convenient and accessible to all users.

Performance Outcomes and Deemed to Satisfy / Designated Performance Outcome Criteria

Movement Systems

PO 1.1

Development integrated with the existing transport system and designed to minimise its potential impact on the functional performance of the transport system.

DTS/DPF 1.1

None are applicable.

PO 1.2

Development is designed to discourage commercial and industrial vehicle movements through residential streets and adjacent other sensitive receivers.

DTS/DPF 1.2

None are applicable.

PO 1.3

Industrial, commercial and service vehicle movements, loading areas and designated parking spaces are separated from passenger vehicle car parking areas to ensure efficient and safe movement and minimise potential conflict.

DTS/DPF 1.3

None are applicable.

PO 1.4

Development sited and designed so that loading, unloading and turning of all traffic likely to be generated avoids interrupting the operation of and queuing on public roads and pedestrian paths.

DTS/DPF 1.4

All vehicle manoeuvring occurs onsite.

Sightlines

PO 2.1

Maintenance or enhancement of sightlines at intersections, pedestrian and cycle crossings, and crossovers to allotments for motorists, cyclists and pedestrians to ensure safety for all road users and pedestrians.

DTS/DPF 2.1

None are applicable.

PO 2.2

Walls, fencing and landscaping adjacent to driveways and corner sites are designed to provide adequate sightlines between vehicles and pedestrians.

DTS/DPF 2.2

None are applicable.

Vehicle Access

PO 3.1

Safe and convenient access that minimises impact or interruption on the operation of public roads.

DTS/DPF 3.1

The access is:

- (a) provided via a lawfully existing or authorised driveway or access point or an access point for which consent has been granted as part of an application for the division of land; and
- (b) not located within 6m of an intersection of 2 or more roads or a pedestrian actuated crossing.

PO 3.2

Development incorporating vehicular access ramps ensures vehicles can enter and exit a site safely and without creating a hazard to pedestrians and other vehicular traffic.

DTS/DPF 3.2

None are applicable.

PO 3.3

Access points sited and designed to accommodate the type and volume of traffic likely to be generated by the development or land use.

DTS/DPF 3.3

None are applicable.

PO 3.4

Access points sited and designed to minimise any adverse impacts on neighbouring properties.

DTS/DPF 3.4

None are applicable.

PO 3.5

Access points located so as not to interfere with mature street trees, existing street furniture (including directional signs, lighting, seating and weather shelters) or infrastructure services to maintain the appearance of the streetscape, preserve local amenity and minimise disruption to utility infrastructure assets.

DTS/DPF 3.5

The access point does not involve the removal or relocation of mature street trees, street furniture or utility infrastructure services.

PO 3.6

Driveways and access points are separated and minimised in number to optimise the provision of on-street visitor parking (where on-street parking is appropriate).

DTS/DPF 3.6

Driveways and access points:

- (a) for sites with a frontage to a public road of 20m or less, one access point no greater than 3.5m in width is provided.
- (b) for sites with a frontage to a public road greater than 20m:
 - i. a single access point no greater than 6m in width is provided; or
 - ii. not more than two access points with a width of 3.5m each are provided.

PO 3.7

Access points appropriately separated from level crossings to avoid interference and ensure their safe ongoing operation.

DTS/DPF 3.7

None are applicable.

PO 3.8

Driveways, access points, access tracks and parking areas are designed and constructed to allow adequate movement and manoeuvrability having regard to the types of vehicles that are reasonably anticipated.

DTS/DPF 3.8

None are applicable.

PO 3.9

Development designed to ensure vehicle circulation between activity areas occurs within the site without the need to use public roads.

DTS/DPF 3.9

None are applicable.

Access for People with Disabilities

PO 4.1

Development sited and designed to provide safe, dignified and convenient access for people with a disability.

DTS/DPF 4.1

None are applicable.

Vehicle Parking Rates

PO 5.1

The provision of sufficient on-site vehicle parking and specifically marked accessible car parking places to meet the needs of the development or land use having regard to factors that may support a reduced on-site rate such as:

- (a) availability of on-street car parking
- (b) shared usage of other parking areas
- (c) in relation to a mixed-use development, where the hours of operation of commercial activities complement the residential use of the site the provision of vehicle parking may be shared.

DTS/DPF 5.1

Development provides a number of car parking spaces on-site at a rate no less than the amount calculated using Transport, Access and Parking Table 1 – General Off-Street Car Parking Requirements or Transport, Access and Parking Table 2 – Off-Street Vehicle Parking Requirements in Designated Areas, whichever is relevant.

Vehicle Parking Areas

PO 6.1

Vehicle parking areas that are sited and designed to minimise impact on the operation of public roads by avoiding the use of public roads when moving from one part of a parking area to another.

DTS/DPF 6.1

Movement between vehicle parking areas within the site can occur without the need to use a public road.

PO 6.2

Vehicle parking areas appropriately located, designed and constructed to minimise impacts on adjacent sensitive receivers through measures such as ensuring they are attractively developed and landscaped, screen fenced, and the like.

DTS/DPF 6.2

None are applicable.

PO 6.3

Vehicle parking areas designed to provide opportunity for integration and shared-use of adjacent car parking areas to reduce the total extent of vehicle parking areas and access points.

DTS/DPF 6.3

None are applicable.

PO 6.4

Pedestrian linkages between parking areas and the development are provided and are safe and convenient.

DTS/DPF 6.4

None are applicable.

PO 6.5

Vehicle parking areas that are likely to be used during non-daylight hours are provided with floodlit entry and exit points to ensure clear visibility to users.

DTS/DPF 6.5

None are applicable.

PO 6.6

Loading areas and designated parking spaces for service vehicles provided within the boundary of the site.

DTS/DPF 6.6

Loading areas and designated parking spaces are wholly located within the site.

PO 6.7

On-site visitor parking spaces are sited and designed to be accessible to all visitors at all times.

DTS/DPF 6.7

None are applicable.

Undercroft and Below Ground Garaging and Parking of Vehicles

PO 7.1

Undercroft and below ground garaging of vehicles designed to enable safe entry and exit from the site without compromising pedestrian or cyclist safety or causing conflict with other vehicles.

DTS/DPF 7.1

None are applicable.

Internal Roads and Parking Areas in Residential Parks and Caravan and Tourist Parks

PO 8.1

Internal road and vehicle parking areas surfaced to prevent dust becoming a nuisance to park residents and occupants.

DTS/DPF 8.1

None are applicable.

PO 8.2

Traffic circulation and movement within the park that is pedestrian friendly and promotes low speed vehicle movement

DTS/DPF 8.2

None are applicable.

Bicycle Parking in Designated Areas

PO 9.1

The provision of adequately sized on-site bicycle parking facilities to encourage cycling as an active transport mode supporting community health.

DTS/DPF 9.1

Areas and / or fixtures are provided for the parking and storage of bicycles at a rate not less than the amount calculated using Transport, Access and Parking Table 3 - Off Street Bicycle Parking Requirements.

PO 9.2

Bicycle parking facilities provide for the secure storage and tethering of bicycles in a place where casual surveillance is possible, is well lit and signed for the safety and convenience of cyclists and to deter property theft.

DTS/DPF 9.2

None are applicable.

PO 9.3

Non-residential development incorporates end-of-journey facilities for employees such as showers, changing facilities and secure lockers, and signage indicating the location of the facilities to encourage cycling as a mode of journey-to-work transport.

DTS/DPF 9.3

None are applicable.

The number of employees

Table 1 – General Off-Street Car Parking Requirements

Class of Development	Car Parking Rate (unless varied by Table 3 onwards) Where a development comprises more than one development type, then the overall car parking rate will be taken to be the sum of the car parking rates for each development type.
Residential Development	
Detached Dwelling	1 or 2 bedroom dwelling – 1 space per dwelling. 3 or more bedroom dwelling – 2 spaces per dwelling.
Group Dwelling	1 or 2 bedroom dwelling – 1 space per dwelling. 3 or more bedroom dwelling – 2 spaces per dwelling. 0.33 spaces per dwelling for visitor parking where development involves 3 or more dwellings.
Residential Flat Building	1 or 2 bedroom dwelling – 1 space per dwelling. 3 or more bedroom dwelling – 2 spaces per dwelling.

Class of Development	Car Parking Rate (unless varied by Table 3 onwards) Where a development comprises more than one development type, then the overall car parking rate will be taken to be the sum of the car parking rates for each development type.
	0.33 spaces per dwelling for visitor parking where development involves 3 or more dwellings.
Row Dwelling	1 or 2 bedroom dwelling – 1 space per dwelling. 3 or more bedroom dwelling – 2 spaces per dwelling.
Semi-Detached Dwelling	1 or 2 bedroom dwelling – 1 space per dwelling. 3 or more bedroom dwelling – 2 spaces per dwelling.
Aged / Supported Accommodation	
Aged person's accommodation	0.3 spaces per bed.
Nursing home	0.3 spaces per bed.
Retirement village	1 or 2 bedroom dwelling – 1 space per dwelling. 3 or more bedroom dwelling – 2 spaces per dwelling. 0.2 spaces per dwelling for visitor parking.
Supported accommodation	0.3 spaces per bed.
Residential Development (Other)	
Ancillary accommodation	No additional requirements beyond those associated with the main dwelling.
Residential park	1 or 2 bedroom dwelling – 1 space per dwelling. 3 or more bedroom dwelling - 2 spaces per dwelling. 0.2 spaces per dwelling for visitor parking.
Workers' accommodation	0.5 spaces per bed plus 0.25 spaces per bed for visitor parking.
Tourist	
Caravan park / tourist park	Parks with 100 sites or less – a minimum of 1 space per 10 sites to be used for accommodation.

Class of Development	Car Parking Rate (unless varied by Table 3 onwards) Where a development comprises more than one development type, then the overall car parking rate will be taken to be the sum of the car parking rates for each development type.
	Parks with more than 100 sites - a minimum of 1 space per 15 sites used for accommodation. A minimum of 1 space for every caravan (permanently fixed to the ground) or cabin.
Tourist accommodation	1 car parking space per accommodation unit / guest room.
Commercial Uses	
Auction room/ depot	1 space per 100m ² of building floor area plus an additional 2 spaces.
Automotive collision repair	3 spaces per 100m ² of gross leasable floor area plus 1 space for each vehicle being serviced, repaired or fitted with accessories, including vehicles waiting to be repaired, fitted with accessories or collected by owners.
Bulky goods outlet	3 spaces per 100m ² of gross leasable floor area.
Call centre	8 spaces per 100m ² of gross leasable floor area.
Motor repair station	3 spaces per 100m ² of gross leasable floor area plus 1 space for each vehicle being serviced, repaired or fitted with accessories, including vehicles waiting to be repaired, fitted with accessories or collected by owners.
Office	4 spaces per 100m ² of gross leasable floor area.
Retail fuel outlet	6 spaces per service bay, plus 50% of the spaces calculated to be provided for ancillary uses
Service trade premises	4 spaces per 100m ² of gross leasable floor area 1 space per 100m ² of outdoor area used for display purposes.
Shop other than a bulky goods outlet or restaurant	7 spaces per 100m ² of gross leasable floor area where not located in an integrated complex containing two or more tenancies (and which may comprise more than one building) where facilities for off-street vehicle

Class of Development	Car Parking Rate (unless varied by Table 3 onwards) Where a development comprises more than one development type, then the overall car parking rate will be taken to be the sum of the car parking rates for each development type.
	<p>parking, vehicle loading and unloading, and the storage and collection of refuse are shared.</p> <p>6 spaces per 100m² of gross leasable floor area where located in an integrated complex containing two or more tenancies (and which may comprise more than one building) where facilities for off-street vehicle parking, vehicle loading and unloading, and the storage and collection of refuse are shared.</p>
Community and Civic Uses	
Childcare centre	0.25 spaces per child
Library	4 spaces per 100m ² of total floor area.
Community facility	10 spaces per 100m ² of total floor area.
Hall / meeting hall	0.2 spaces per seat.
Place of worship	1 space for every 3 visitor seats.
Pre-school	1 per employee plus 0.25 per child (drop off/pick up bays)
Educational establishment	<p>For a primary school - 1.1 space per full time equivalent employee plus 0.25 spaces per student.</p> <p>For a secondary school - 1.1 per full time equivalent employee plus 0.16 spaces per student</p> <p>For a tertiary institution - 0.8 per student based on the maximum number of students on the site at any time.</p>
Health Related Uses	
Hospital	5 spaces per bed.
Consulting room	4 spaces per 100m ² of gross leasable floor area.

Class of Development	Car Parking Rate (unless varied by Table 3 onwards) Where a development comprises more than one development type, then the overall car parking rate will be taken to be the sum of the car parking rates for each development type.
Recreational and Entertainment Uses	
Amusement machine centre	1 space per 10m ² of total floor area.
Bowling club	10 spaces per bowling green.
Cinema complex	0.33 spaces per seat.
Concert hall / theatre	0.33 spaces per seat.
Hotel	1 space for every 2m ² of total floor area in a public bar plus 1 space for every 6m ² of total floor area available to the public in a lounge, beer garden or other licensed area.
Indoor recreation facility	7 spaces per 100m ² of total floor area For a squash court or tennis court – 4 spaces per court.
Restaurant	Premises with a dine-in service only - 0.4 spaces per seat. Premises with a dine-in and take-away services - 0.55 spaces per seat. [Note: requirements associated with a drive-through service are to be considered separately to the parking rates mentioned herein]
Industry/Employment Uses	
Fuel depot	If employee numbers are known - 1 space per employee with a minimum of 2 spaces per premises. If employee numbers are unknown - 1.85 spaces per 100m ² of total floor area with a minimum of 2 spaces per premises.
Industry	If employee numbers are known - 1 space per employee with a minimum of 2 spaces per premises. If employee numbers are unknown - 1.85 spaces per 100m ² of total floor area with a minimum of 2 spaces per premises.

Class of Development	Car Parking Rate (unless varied by Table 3 onwards) Where a development comprises more than one development type, then the overall car parking rate will be taken to be the sum of the car parking rates for each development type.
Store	If employee numbers are known - 1 space per employee with a minimum of 2 spaces per premises. If employee numbers are unknown - 1.85 spaces per 100m ² of total building floor area with a minimum of 2 spaces per premises.
Timber yard	If employee numbers are known - 1 space per employee with a minimum of 2 spaces per premises. If employee numbers are unknown - 1.85 spaces per 100m ² of total floor area with a minimum of 2 spaces per premises.
Warehouse	If employee numbers are known - 1 space per employee with a minimum of 2 spaces per premises. If employee numbers are unknown - 1.85 spaces per 100m ² of total floor area with a minimum of 2 spaces per premises.
Other Uses	
Funeral Parlour	1 space per 5 seats in the chapel plus 1 space for each vehicle operated by the parlour.
Radio or Television Station	5 spaces per 100m ² of total building floor area.

Table 2 – Off-Street Vehicle Parking Requirements in Designated Areas

Class of Development	Car Parking Rate		Designated Areas
	Minimum number of spaces	Maximum number of spaces	
Development generally			
All classes of development	No minimum.	No maximum.	Capital City Zone City Main Street Zone
Non-residential development			
Non-residential development excluding tourist accommodation	3 spaces per 100m ² of gross leasable floor area.	5 spaces per 100m ² of gross leasable floor area.	Urban Activity Centre Zone Urban Corridor (Boulevard) Zone Urban Corridor (Business) Zone Urban Corridor (Living) Zone Urban Corridor (Main Street) Zone Urban Neighbourhood Zone
Non-residential development excluding tourist accommodation	3 spaces per 100m ² of gross leasable floor area.	6 spaces per 100m ² of gross leasable floor area.	Where located in accordance with the Table 2 - Criteria: Business Neighbourhood Zone Education and Innovation Zone Suburban Activity Centre Zone Suburban Business and Innovation Zone Suburban Main Street Zone Urban Activity Centre Zone

Class of Development	Car Parking Rate		Designated Areas
	Minimum number of spaces	Maximum number of spaces	
Tourist accommodation	1 space for every 4 bedrooms up to 100 bedrooms plus 1 space for every 5 bedrooms over 100 bedrooms	1 space per 2 bedrooms up to 100 bedrooms and 1 space per 4 bedrooms over 100 bedrooms	Urban Activity Centre Zone Urban Corridor (Boulevard) Zone Urban Corridor (Business) Zone Urban Corridor (Living) Zone Urban Corridor (Main Street) Zone Urban Neighbourhood Zone
Residential development			
Residential component of a multi-storey building	Dwelling with no separate bedroom – 0.25 spaces per dwelling 1 bedroom dwelling – 0.75 spaces per dwelling 2 bedroom dwelling – 1 space per dwelling 3 or more bedroom dwelling – 1.25 spaces per dwelling 0.25 spaces per dwelling for visitor parking.	None specified.	Urban Activity Centre Zone Urban Corridor (Boulevard) Zone Urban Corridor (Business) Zone Urban Corridor (Living) Zone Urban Corridor (Main Street) Zone Urban Neighbourhood Zone
Residential flat building	Dwelling with no separate bedroom – 0.25 spaces per dwelling 1 bedroom dwelling – 0.75 spaces per dwelling	None specified.	Urban Activity Centre Zone Urban Corridor (Boulevard) Zone Urban Corridor (Business) Zone

Class of Development	Car Parking Rate		Designated Areas
	Minimum number of spaces	Maximum number of spaces	
	Where a development comprises more than one development type, then the overall car parking rate will be taken to be the sum of the car parking rates for each development type. 2 bedroom dwelling – 1 space per dwelling 3 or more bedroom dwelling – 1.25 spaces per dwelling 0.25 spaces per dwelling for visitor parking.		Urban Corridor (Living) Zone Urban Corridor (Main Street) Zone Urban Neighbourhood Zone

Table 2 - Criteria:

The designated area is wholly located within Metropolitan Adelaide and any part of the area satisfies one of the following:

- (a) is within 400 metres of a bus interchange⁽¹⁾
- (b) is within 400 metres of an O-Bahn interchange⁽¹⁾
- (c) is within 400 metres of a passenger rail station⁽¹⁾
- (d) is within 400 metres of a passenger tram station⁽¹⁾
- (e) is within 400 metres of the Adelaide Parklands.

[NOTE(S): (1) Measured from an area that contains any platform(s), shelter(s) or stop(s) where people congregate for the purpose waiting to board a bus, tram or train, but does not include areas used for the parking of vehicles.]

Table 3 – Off-Street Bicycle Parking Requirements

The bicycle parking rates apply within designated areas located within parts of the State identified in the Schedule to Table 3.

Class of Development	Bicycle Parking Rate Where a development comprises more than one development type, then the overall bicycle parking rate will be taken to be the sum of the bicycle parking rates for each development type.
Consulting Room	1 space per 20 employees plus 1 space per 20 consulting rooms for customers.
Educational establishment	For a secondary school – 1 space per 20 full-time time employees plus 10 percent of the total number of employee spaces for visitors. For tertiary education – 1 space per 20 employees plus 1 space per 10 full time students.
Hospital	1 space per 15 beds plus 1 space per 30 beds for visitors.
Indoor recreation facility	1 space per 4 employees plus 1 space per 200m ² of gross leasable floor area for visitors.
Office	1 space for every 200m ² of gross leasable floor area plus 2 spaces plus 1 space per 1000m ² of gross leasable floor area for visitors.
Residential flat building	1 space for every 4 dwellings for residents plus 1 for every 10 dwellings for visitors.
Residential component of a multi-storey building	1 space for every 4 dwellings for residents plus 1 space for every 10 dwellings for visitors.
Shop	1 space for every 300m ² of gross leasable floor area plus 1 space for every 600m ² of gross leasable floor area for customers.
Tourist accommodation	1 space for every 20 employees plus 2 for the first 40 rooms and 1 for every additional 40 rooms for visitors.

Schedule to Table 3

Designated Area	Relevant part of the State The bicycle parking rate applies to a designated area located in a relevant part of the State described below.
All zones	City of Adelaide
Business Neighbourhood Zone Education and Innovation Zone Suburban Activity Centre Zone Suburban Business and Innovation Zone Suburban Main Street Zone Urban Activity Centre Zone Urban Corridor (Boulevard) Zone Urban Corridor (Business) Zone Urban Corridor (Living) Zone Urban Corridor (Main Street) Zone Urban Neighbourhood Zone	Metropolitan Adelaide

Waste Treatment and Management Facilities

Assessment Provisions (AP)

Desired Outcomes (DO)

DO 1

Mitigation of potential environmental and amenity impacts of waste treatment and management facilities.

Performance Outcomes and Deemed to Satisfy / Designated Performance Outcome Criteria

Siting

PO 1.1

Waste treatment and management facilities incorporate separation distances and attenuation measures within the site between waste operations areas (including all closed, operating and future cells) and sensitive receivers and sensitive environmental features to mitigate off-site impacts from noise, air and dust emissions.

DTS/DPF 1.1

None are applicable.

Soil and Water Protection

PO 2.1

Soil, groundwater and surface water protected from contamination from waste treatment and management facilities through measures such as:

- (a) containing potential groundwater and surface water contaminants within waste operations areas;
- (b) diverting clean stormwater away from waste operations areas and potentially contaminated areas; and
- (c) providing a leachate barrier between waste operations areas and underlying soil and groundwater.

DTS/DPF 2.1

None are applicable.

PO 2.2

Wastewater lagoons setback from watercourses to minimise environmental harm and adverse effects on water resources.

DTS/DPF 2.2

Wastewater lagoons are setback 50m or more from watercourse banks.

PO 2.3

Wastewater lagoons designed and sited to:

- (a) avoid intersecting underground waters;
- (b) avoid inundation by flood waters;
- (c) ensure lagoon contents do not overflow; and
- (d) include a liner designed to prevent leakage.

DTS/DPF 2.3

None are applicable.

PO 2.4

Waste operations areas of landfills and organic waste processing facilities setback from watercourses to minimise adverse impacts on water resources.

DTS/DPF 2.4

Waste operations areas are setback 100m or more from watercourse banks.

Amenity

PO 3.1

Waste treatment and management facilities are screened, located and designed to minimise adverse visual impacts on amenity.

DTS/DPF 3.1

None are applicable.

PO 3.2

Access routes to waste treatment and management facilities via residential streets is avoided.

DTS/DPF 3.2

None are applicable.

PO 3.3

Litter control measures minimise the incidence of windblown litter.

DTS/DPF 3.3

None are applicable.

PO 3.4

Waste treatment and management facilities are designed to minimise adverse impacts on both the site and surrounding areas from weed and vermin infestation.

DTS/DPF 3.4

None are applicable.

Access

PO 4.1

Traffic circulation movements within any waste treatment or management site designed to enable all vehicles expected to use the facility to enter and exit the site in a forward direction.

DTS/DPF 4.1

None are applicable.

PO 4.2

Suitable access for emergency vehicles provided to and within waste treatment or management sites.

DTS/DPF 4.2

None are applicable.

Fencing and Security

PO 5.1

Security fencing provided around waste treatment and management facilities to prevent unauthorised access to operations and potential hazard to the public

DTS/DPF 5.1

Chain wire mesh or pre-coated painted metal fencing 2m or more in height is erected along the perimeter of the waste treatment or waste management facility site.

Landfill

PO 6.1

Landfill gas emissions managed in an environmentally acceptable manner.

DTS/DPF 6.1

None are applicable.

PO 6.2

Landfill facilities separated from areas of environmental significance and land used for public recreation and enjoyment.

DTS/DPF 6.2

Landfill facilities are setback 250m or more from a public open space reserve, forest reserve, national park or the Conservation Zone.

PO 6.3

Landfill facilities located on land that is not subject to land slip.

DTS/DPF 6.3

None are applicable.

PO 6.4

Landfill facilities separated from areas subject to flooding to avoid potential environmental harm.

DTS/DPF 6.4

Landfill facilities are setback 500m or more from land inundated in a 1% AEP flood event.

Organic Waste Processing Facilities

PO 7.1

Organic waste processing facilities separated from the coast to avoid potential environment harm.

DTS/DPF 7.1

Organic waste processing facilities are setback 500m or more from coastal high water mark.

PO 7.2

Organic waste processing facilities not located on land where the interface of the engineered liner and natural soils would be within any of the following:

- a. 15m of unconfined aquifers bearing groundwater with less than 3,000mg per litre total dissolved salts; or
- b. 5m of groundwater with a water quality of 3,000mg to 12,000mg per litre total dissolved salts; or
- c. 2m of groundwater with a water quality exceeding 12,000mg per litre total dissolved salts.

DTS/DPF 7.2

None are applicable.

PO 7.3

Organic waste processing facilities sited away from areas of environmental significance and land used for public recreation and enjoyment.

DTS/DPF 7.3

Organic waste processing facilities are setback 250m or more from a public open space reserve, forest reserve, national park or the Conservation Zone.

PO 7.4

Organic waste processing facilities located on land that is not subject to land slip.

DTS/DPF 7.4

None are applicable.

PO 7.5

Organic waste processing facilities separated from areas subject to flooding to avoid potential environmental harm.

DTS/DPF 7.5

Organic waste processing facilities are setback 500m or more from land inundated in a 1% AEP flood event.

Major Wastewater Treatment Facilities

PO 8.1

Major wastewater treatment and disposal systems, including lagoons, designed to minimise potential adverse odour impacts on sensitive receivers.

DTS/DPF 8.1

None are applicable.

PO 8.2

Artificial wetland systems for the storage of treated wastewater designed and sited to minimise potential public health risks arising from the breeding of mosquitoes.

DTS/DPF 8.2

None are applicable.

Workers Accommodation and Settlements

Assessment Provisions (AP)

Desired Outcomes (DO)

DO 1

Appropriately designed and located accommodation for seasonal and short-term workers in rural areas that minimises environmental and social impacts.

Performance Outcomes and Deemed to Satisfy / Designated Performance Outcome Criteria

PO 1.1

Workers accommodation and settlements sited and designed to minimise impacts on views from scenic routes, tourist destinations and areas of conservation significance.

DTS/DPF 1.1

None are applicable.

PO 1.2

Workers accommodation and settlements sited and designed to minimise nuisance impacts on the amenity of adjacent users of land.

DTS/DPF 1.2

None are applicable.

PO 1.3

Workers accommodation and settlements designed with materials and colours that blend with the landscape.

DTS/DPF 1.3

None are applicable.

PO 1.4

Workers accommodation and settlements supplied with service infrastructure such as power, water and effluent disposal sufficient to satisfy the living requirements of workers.

DTS/DPF 1.4

None are applicable.

Part 5 – Designated Areas

Under the *Planning, Development and Infrastructure (General) Regulations* the Planning and Design Code may designate a zone, subzone, overlay or identify other areas for certain purposes.

Column A identifies the purpose of a designated area and Column B identifies the relevant zone, subzone or overlay in the Planning and Design Code or other area designated for that purpose, including limits to the extent of a designated area.

Where the extent of a designated area is limited in Column B by a figure, the figure is provided in Schedule 1 of this Part.

Table 1 – Designated Areas

Introduction (Column A)	Designated Area(s) (Column B)
Interpretation	
Areas identified as 'designated 'airport building heights area' for the purposes of clause 3(1) of the Regulations – Interpretation	Airport Building Heights (Aircraft Landing Areas) Overlay Airport Building Heights (Regulated) Overlay Defence Aviation Area Overlay
Areas identified as 'designated environmental zone, subzone or overlay' for the purposes of clause 3(1) of the Regulations – Interpretation	None specified
Areas identified as 'designated flood zone, subzone or overlay' for the purposes of clause 3(1) of the Regulations – Interpretation	Coastal Areas Overlay Hazards (Flooding) Overlay River Murray Flood Plain Overlay
Areas identified as 'designated regulated tree overlay' for the purposes of clause 3(1) of the Regulations – Interpretation	Regulated Tree Overlay
Building Rules: bushfire prone areas	
Areas identified as 'designated bushfire prone areas' for the purposes of clause 98(b) of the Regulations – Building Rules: bushfire prone areas	Hazards (Bushfire - General Risk) Overlay Hazards (Bushfire - High Risk) Overlay Hazards (Bushfire - Medium Risk) Overlay Hazards (Bushfire - Outback) Overlay Hazards (Bushfire - Regional) Overlay Hazards (Bushfire – Urban Interface) Overlay
Additions to definition of development	
Areas identified for the purposes of clause 1 of	Hills Face Zone Significant Landscape Protection Overlay Hazard (Acid Sulfate Soils) Overlay

Introduction (Column A)	Designated Area(s) (Column B)
Schedule 3 under the Regulations – Excavating or filling in identified zones or areas	Sloping Land Overlay
Areas identified for the purposes of clause 3 of Schedule 3 under the Regulations – Excavation or filling in identified zones or areas subject to inundation or flooding	<p>In addition to a 'designated flood zone, subzone or overlay', the following:</p> <p>None specified</p>
Exclusions from definition of development - general	
Areas identified as 'environmental areas' for the purposes of clause 2(1)(d)(i) of Schedule 4 under the Regulations – Council works	<p>Conservation Zone Significant Landscape Protection Overlay</p> <p>Consider deleting from the regulations as unsure of the purpose of this provision.</p>
Areas identified as 'environmental areas' for the purposes of clause 2(1)(d)(ii)(A) of Schedule 4 under the Regulations – Council works	<p>Coastal Areas Overlay</p> <p>As above – consider deleting from the regulations as unsure of the purpose of this provision.</p>
Areas identified for the purposes of clause 4 (1)(a) of Schedule 4 under the Regulations – Outbuilding	<p>In addition to a 'designated flood zone, subzone or overlay', the following:</p> <p>Hills Face Zone Significant Landscape Protection Overlay</p>
Areas identified for the purposes of clause 4(1)(c) of Schedule 4 under the Regulations – Swimming pool	<p>In addition to a 'designated flood zone, subzone or overlay', the following:</p> <p>Hills Face Zone</p>
Areas identified for the purposes of clause 4 (1)(d)(i)(B) of Schedule 4 under the Regulations – Fence not exceeding 2.1m in height	<p>In addition to a 'designated flood zone, subzone or overlay', the following:</p> <p>Hills Face Zone Significant Landscape Protection Overlay</p>
Areas identified for the purposes of clause 4(1)(i) of	<p>In addition to a 'designated bushfire prone area', the following:</p> <p>Coastal Areas Overlay</p>

Introduction (Column A)	Designated Area(s) (Column B)
Schedule 4 under the Regulations – Deck	Hills Face Zone Significant Landscape Protection Overlay
Areas identified for the purposes of clause 4(9) of Schedule 4 under the Regulations – External painting of a building	Any building located within the area identified in Figure Ga/1 or Figure Ga/2 of Schedule 1.
Areas identified for the purposes of clause 10 of Schedule 4 under the Regulations – Demolition of the whole of a building	Historic Area Overlay
Areas identified for the purposes of clause 11 of Schedule 4 under the Regulations – Dams	In addition to a 'designated flood zone, subzone or overlay', the following: Hills Face Zone Significant Landscape Protection Overlay
Areas identified for the purposes of clause 13 of Schedule 4 under the Regulations – Aerials, towers	In addition to a 'designated flood zone, subzone or overlay', the following: Hills Face Zone Significant Landscape Protection Overlay
Relevant authority - Commission	
Areas identified for the purposes of clause 4(1) of Schedule 6 of the Regulations – Buildings exceeding 4 storeys	Design Overlay
Areas identified for the purposes of clause 5(1) of Schedule 6 of the Regulations – Developments over \$3m in the City of Port Adelaide	Design Overlay
Areas identified for the purposes of clause 8(1) of Schedule 6 of the Regulations – Developments over \$3m in the City of Charles Sturt	Design Overlay
Areas identified for the purposes of clause 11 of Schedule 6 of the Regulations – Developments in the show grounds	Recreation Zone in the City of Unley shown in Figure Un/1 of Schedule 1.
Areas identified for the purposes of clause 12 of	Conservation Zone

Introduction (Column A)	Designated Area(s) (Column B)
Schedule 6 of the Regulations – Tourism developments over \$3m on Kangaroo Island	
State agency development exempt from approval	
Areas identified for the purposes of clause 3 of Schedule 13 of the Regulations - Certain development in part of City of Mitcham	The area identified in Figure Mit/1 of Schedule 1 in connection with the

Schedule 1 — Figures for Designated Areas

Location	Figures
<p>Corporation of the Town of Gawler</p>	<p>Figure Ga/1</p> 
	<p>Figure Ga/2</p> 
<p>City of Mitcham – Colonel Light Gardens</p>	<p>Figure Mit/1</p>

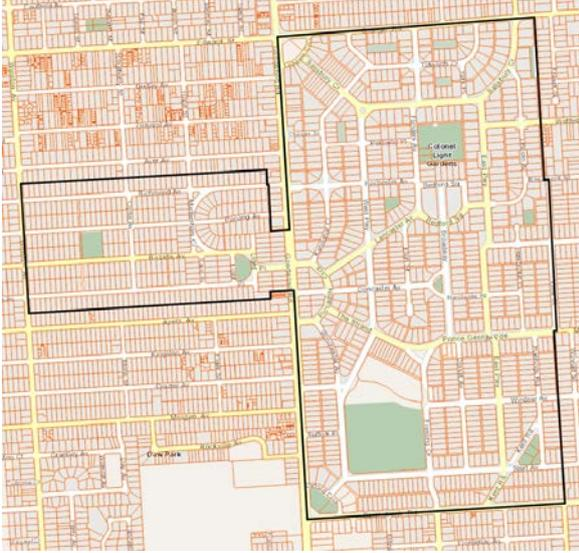
Location	Figures
	
City of Unley	<p data-bbox="582 864 742 907">Figure Un/1</p> 

Part 6 – Index of Technical and Numeric Variations

Part 6.4 Minimum Allotment Sizes

Minimum lot size for a residential flat building is 300 sqm
Minimum lot size for a group dwelling is 300 sqm
Minimum lot size is 81 sqm
Minimum lot size for a detached dwelling is 100 sqm; semi-detached dwelling is 100 sqm; row dwelling is 100 sqm; group dwelling is 100 sqm; residential flat building is 100 sqm
Minimum lot size is 120 sqm
Minimum lot size for a detached dwelling is 120 sqm; semi-detached dwelling is 120 sqm; row dwelling is 120 sqm; group dwelling is 120 sqm; residential flat building is 120 sqm
Minimum lot size is 150 sqm
Minimum lot size for a detached dwelling is 150 sqm; semi-detached dwelling is 150 sqm
Minimum lot size is 200 sqm
Minimum lot size is 250 sqm
Minimum lot size is 300 sqm
Minimum lot size for a detached dwelling is 300 sqm; semi-detached dwelling is 270 sqm; row dwelling is 200 sqm
Minimum lot size for a detached dwelling is 300 sqm; semi-detached dwelling is 300 sqm
Minimum lot size for a detached dwelling is 300 sqm; semi-detached dwelling is 300 sqm; group dwelling is 300 sqm
Minimum lot size for a detached dwelling is 300 sqm; semi-detached dwelling is 300 sqm; row dwelling is 200 sqm; group dwelling is 300 sqm; residential flat building is 300 sqm
Minimum lot size for a detached dwelling is 300 sqm; semi-detached dwelling is 300 sqm; row dwelling is 300 sqm; group dwelling is 300 sqm
Minimum lot size for a detached dwelling is 300 sqm; semi-detached dwelling is 300 sqm; row dwelling is 300 sqm; group dwelling is 300 sqm; residential flat building is 300 sqm
Minimum lot size is 350 sqm
Minimum lot size for a detached dwelling is 350 sqm; semi-detached dwelling is 300 sqm; row dwelling is 250 sqm
Minimum lot size for a detached dwelling is 350 sqm; semi-detached dwelling is 350 sqm; row dwelling is 350 sqm
Minimum lot size for a detached dwelling is 350 sqm; semi-detached dwelling is 350 sqm; row dwelling is 350 sqm; group dwelling is 350 sqm; residential flat building is 350 sqm
Minimum lot size for a detached dwelling is 350 sqm; semi-detached dwelling is 350 sqm; row dwelling is 450 sqm; group dwelling is 350 sqm; residential flat building is 350 sqm
Minimum lot size is 400 sqm
Minimum lot size for a detached dwelling is 400 sqm; semi-detached dwelling is 250 sqm; row dwelling is 350 sqm; group dwelling is 300 sqm; residential flat building is 300 sqm
Minimum lot size for a detached dwelling is 400 sqm; semi-detached dwelling is 400 sqm
Minimum lot size for a detached dwelling is 420 sqm; semi-detached dwelling is 375 sqm
Minimum lot size for a detached dwelling is 420 sqm; semi-detached dwelling is 420 sqm
Minimum lot size is 450 sqm
Minimum lot size for a detached dwelling is 450 sqm; semi-detached dwelling is 250 sqm; row dwelling is 250 sqm; group dwelling is 350 sqm; residential flat building is 250 sqm
Minimum lot size for a detached dwelling is 450 sqm; semi-detached dwelling is 270 sqm; row dwelling is 300 sqm; group dwelling is 250 sqm; residential flat building is 250 sqm
Minimum lot size for a detached dwelling is 450 sqm; semi-detached dwelling is 300 sqm; row dwelling is 250 sqm; group dwelling is 300 sqm; residential flat building is 300 sqm
Minimum lot size for a detached dwelling is 450 sqm; semi-detached dwelling is 300 sqm; row dwelling is 350 sqm; group dwelling is 300 sqm; residential flat building is 300 sqm

Minimum lot size for a detached dwelling is 750 sqm; semi-detached dwelling is 600 sqm
Minimum lot size for a detached dwelling is 750 sqm; semi-detached dwelling is 750 sqm; row dwelling is 750 sqm; group dwelling is 750 sqm; residential flat building is 750 sqm
Minimum lot size is 800 sqm
Minimum lot size for a detached dwelling is 800 sqm; row dwelling is 180 sqm; group dwelling is 250 sqm; residential flat building is 250 sqm
Minimum lot size for a detached dwelling is 800 sqm; semi-detached dwelling is 500 sqm; row dwelling is 500 sqm; group dwelling is 500 sqm; residential flat building is 500 sqm
Minimum lot size is 900 sqm
Minimum lot size for a detached dwelling is 900 sqm; group dwelling is 300 sqm
Minimum lot size for a detached dwelling is 900 sqm; semi-detached dwelling is 900 sqm; group dwelling is 900 sqm
Minimum lot size is 1000 sqm
Minimum lot size for a detached dwelling is 1000 sqm; semi-detached dwelling is 600 sqm; row dwelling is 400 sqm; group dwelling is 500 sqm
Minimum lot size for a detached dwelling is 1000 sqm; semi-detached dwelling is 600 sqm; row dwelling is 450 sqm; group dwelling is 1200 sqm; residential flat building is 450 sqm
Minimum lot size for a detached dwelling is 1000 sqm; semi-detached dwelling is 850 sqm
Minimum lot size is 1200 sqm
Minimum lot size is 1300 sqm
Minimum lot size is 1500 sqm
Minimum lot size is 1800 sqm
Minimum lot size for a detached dwelling is 1860 sqm; semi-detached dwelling is 1860 sqm
Minimum lot size is 2000 sqm
Minimum lot size is 2500 sqm
Minimum lot size is 2800 sqm
Minimum lot size is 3000 sqm
Minimum lot size is 4000 sqm
Minimum lot size is 5000 sqm
Minimum lot size is 7500 sqm
Minimum lot size is 8000 sqm
Minimum lot size is 10000 sqm
Minimum lot size is 12000 sqm
Minimum lot size is 15000 sqm
Minimum lot size is 20000 sqm
Minimum lot size for a detached dwelling is 20000 sqm; residential flat building is 300 sqm
Minimum lot size is 25000 sqm
Minimum lot size is 30000 sqm
Minimum lot size is 40000 sqm
Minimum lot size is 50000 sqm
Minimum lot size is 70000 sqm
Minimum lot size is 80000 sqm
Minimum lot size is 100000 sqm
Minimum lot size is 120000 sqm
Minimum lot size is 160000 sqm
Minimum lot size is 200000 sqm
Minimum lot size is 250000 sqm
Minimum lot size is 300000 sqm
Minimum lot size is 330000 sqm

Minimum lot size is 400000 sqm

Minimum lot size is 1000000 sqm

Minimum lot size is 2000000 sqm

Minimum lot size is 4000000 sqm

Minimum lot size is 9000000 sqm

Part 6.5 Minimum Allotment Frontage Sizes

Minimum Allotment Frontage
Minimum frontage for a residential flat building is 15m
Minimum frontage for a group dwelling is 15m
Minimum frontage for a detached dwelling is 10m
Minimum frontage for a detached dwelling is 10m; semi-detached dwelling is 10m; row dwelling is 10m; group dwelling is 10m; residential flat building is 10m
Minimum frontage for a detached dwelling is 10m; semi-detached dwelling is 9m; row dwelling is 7m
Minimum frontage for a detached dwelling is 10m; semi-detached dwelling is 9m; row dwelling is 6m; group dwelling is 10m; residential flat building is 10m
Minimum frontage for a detached dwelling is 11m; semi-detached dwelling is 11m; row dwelling is 8m
Minimum frontage for a detached dwelling is 12m
Minimum frontage for a detached dwelling is 12m; semi-detached dwelling is 10m; row dwelling is 8m; group dwelling is 12m; residential flat building is 12m
Minimum frontage for a detached dwelling is 12m; semi-detached dwelling is 10m; group dwelling is 20m
Minimum frontage for a detached dwelling is 12m; semi-detached dwelling is 10m; row dwelling is 7m; group dwelling is 25m; residential flat building is 25m
Minimum frontage for a detached dwelling is 12m; semi-detached dwelling is 12m
Minimum frontage for a detached dwelling is 12m; semi-detached dwelling is 12m; row dwelling is 12m
Minimum frontage for a detached dwelling is 12m; semi-detached dwelling is 12m; row dwelling is 12m; group dwelling is 12m; residential flat building is 12m
Minimum frontage for a detached dwelling is 12m; semi-detached dwelling is 8m; row dwelling is 8m
Minimum frontage for a detached dwelling is 12m; semi-detached dwelling is 9m
Minimum frontage for a detached dwelling is 12m; semi-detached dwelling is 9m; row dwelling is 18m; group dwelling is 18m; residential flat building is 18m
Minimum frontage for a detached dwelling is 12m; semi-detached dwelling is 9m; row dwelling is 7m; group dwelling is 20m; residential flat building is 20m
Minimum frontage for a detached dwelling is 12m; semi-detached dwelling is 9m; row dwelling is 7m; group dwelling is 6m; residential flat building is 6m
Minimum frontage for a detached dwelling is 13m; semi-detached dwelling is 10m; row dwelling is 7m; group dwelling is 18m; residential flat building is 18m
Minimum frontage for a detached dwelling is 14m
Minimum frontage for a detached dwelling is 14m; semi-detached dwelling is 10m; row dwelling is 7m; group dwelling is 18m; residential flat building is 18m
Minimum frontage for a detached dwelling is 14m; semi-detached dwelling is 12m
Minimum frontage for a detached dwelling is 14m; semi-detached dwelling is 12m; group dwelling is 14m
Minimum frontage for a detached dwelling is 14m; semi-detached dwelling is 12m; group dwelling is 18m; residential flat building is 18m
Minimum frontage for a detached dwelling is 14m; semi-detached dwelling is 12m; row dwelling is 7m; group dwelling is 18m

Minimum frontage for a detached dwelling is 17m; semi-detached dwelling is 8m; row dwelling is 8m; group dwelling is 18m
Minimum frontage for a detached dwelling is 18m
Minimum frontage for a detached dwelling is 18m; row dwelling is 7m; group dwelling is 24m; residential flat building is 15m
Minimum frontage for a detached dwelling is 18m; semi-detached dwelling is 12m; row dwelling is 10m; group dwelling is 24m; residential flat building is 20m
Minimum frontage for a detached dwelling is 18m; semi-detached dwelling is 15m; row dwelling is 10m; group dwelling is 20m
Minimum frontage for a detached dwelling is 18m; semi-detached dwelling is 18m
Minimum frontage for a detached dwelling is 20m
Minimum frontage for a detached dwelling is 20m; semi-detached dwelling is 18m
Minimum frontage for a detached dwelling is 21m
Minimum frontage for a detached dwelling is 23m
Minimum frontage for a detached dwelling is 24m; semi-detached dwelling is 24m
Minimum frontage for a detached dwelling is 25m
Minimum frontage for a detached dwelling is 25m; semi-detached dwelling is 20m; row dwelling is 20m; group dwelling is 20m; residential flat building is 20m
Minimum frontage for a detached dwelling is 30m
Minimum frontage for a detached dwelling is 40m
Minimum frontage for a detached dwelling is 5m; semi-detached dwelling is 5m; group dwelling is 5m
Minimum frontage for a detached dwelling is 50m
Minimum frontage for a detached dwelling is 6m; semi-detached dwelling is 6m; row dwelling is 6m; group dwelling is 6m
Minimum frontage for a detached dwelling is 6m; semi-detached dwelling is 6m; row dwelling is 6m; group dwelling is 6m; residential flat building is 6m
Minimum frontage for a detached dwelling is 85m
Minimum frontage for a detached dwelling is 9m
Minimum frontage for a detached dwelling is 9m; semi-detached dwelling is 7.5m; row dwelling is 7.5m; group dwelling is 14m; residential flat building is 14m
Minimum frontage for a detached dwelling is 9m; semi-detached dwelling is 8m; row dwelling is 8m
Minimum frontage for a detached dwelling is 9m; semi-detached dwelling is 9m; group dwelling is 15m
Minimum frontage for a detached dwelling is 9m; semi-detached dwelling is 9m; row dwelling is 15m; group dwelling is 15m
Minimum frontage for a detached dwelling is 9m; semi-detached dwelling is 9m; row dwelling is 7m; group dwelling is 15m; residential flat building is 15m
Minimum frontage for a detached dwelling is 9m; semi-detached dwelling is 9m; row dwelling is 6m; group dwelling is 18m; residential flat building is 18m

Part 6.6 Building Heights (Metres)

Maximum Building Height (Metres)
10
11.5
12
12.5
13.5
15
18
18.5
22
25
25.5
29
3
36
4
4.5
5.6
5.7
6
6.5
8
8.5
9

Part 6.7 Building Heights (Levels)

Minimum Building Height (Levels)	
	1
	2
	3
	5
	4

Maximum Building Height (Levels)	
	1
	2
	3
	4
	5
	6
	7
	8
	10
	12

Part 7 – Land Use Definitions

Land Use Terms

The following table lists terms which may be used in this Planning and Design Code in relation to the use of land.

Meaning of Terms

A term listed in Column A has the meaning set out beside that term in Column B.

Inclusions and Exclusions

Land uses and activities set out in Column C are to be taken as being **included** in the meaning of the land use term set out in Column A.

Land uses and activities set out in Column D are to be taken as being **excluded** from the meaning of the land use term set out in Column A.

In the event of any inconsistency Column D prevails over Column C.

Ancillary and Subordinate

Unless stated to the contrary, a term set out in the following table which purports to define a form of land use will be taken to include a use which is ancillary and subordinate to that defined use.

No Definition

A term not defined in the following table will have its ordinary meaning unless the term is defined in the *Planning, Development and Infrastructure Act 2016* or its Regulations (or any relevant practice direction or practice guideline issued by the State Planning Commission) in which case that meaning will apply.

Land Use Definitions Table LUD

Land Use Term (Column A)	Definition (Column B)	Includes (Column C)	Excludes (Column D)
Agricultural building	Means a building used wholly or partly for purposes associated with farming, commercial forestry or horticulture, or to support the operations of that use, but is not used wholly or partly for the processing or packaging of commodities.	Farm shed; Horticultural shed; Hay shed; Implement shed; Pump shed.	Dairy; Dwelling; Industry; Intensive animal husbandry; Office; Outbuilding; Shop.
Ancillary accommodation	Means accommodation that: (a) is located on the same allotment as an existing dwelling; (b) contains no more than 1 bedroom or room or area capable of being used as a bedroom; and (c) is subordinate to and shares the same utilities of the existing dwelling.		
Animal keeping	Means the boarding (short or long term), keeping, breeding or training of animals, except horses and/or commercially kept livestock.	Dog kennelling Catteries	Aquaculture; Farming; Horse keeping; Intensive animal husbandry; Low intensity animal husbandry.
Aquaculture	Has the same meaning as in the <i>Aquaculture Act 2001</i> .		Intensive animal husbandry.
Automotive collision repair	Means repairs to motor vehicles involving structural repairs, panel beating, replacement of vehicle body parts or spray painting.		Motor repair station
Bulky goods outlet	Means premises used primarily for the sale, rental, display or offer by retail of goods, other than foodstuffs, clothing, footwear or personal effects goods, unless the sale, rental, display or offer by retail of the foodstuffs, clothing, footwear or personal effects goods is incidental to the		

Land Use Term (Column A)	Definition (Column B)	Includes (Column C)	Excludes (Column D)
	<p>sale, rental, display or offer by retail of other goods.</p> <p>Examples— The following are examples of goods that may be available or on display at bulky goods outlets:</p> <ul style="list-style-type: none"> (a) automotive parts and accessories; (b) furniture; (c) floor coverings; (d) window coverings; (e) appliances or electronic equipment; (f) home entertainment goods; (g) lighting and electric light fittings; (h) curtains and fabric; (i) bedding and manchester; (j) party supplies; (k) animal and pet supplies; (l) camping and outdoor recreation supplies; (m) hardware; (n) garden plants (primarily in an indoor setting); (o) office equipment and stationery supplies; (p) baby equipment and accessories; (q) sporting, fitness and recreational equipment and accessories; (r) homewares; (s) children's play equipment. 		
Caravan and tourist park	Means land used to provide short-term accommodation in caravans, recreational vehicles (RVs) cabins, tents		Residential park

Land Use Term (Column A)	Definition (Column B)	Includes (Column C)	Excludes (Column D)
	and other similar demountable forms of shelter in a managed setting.		
Commercial forestry	Means the practice of planting, managing, and caring for forests that are to be harvested (or intended to be harvested) or used for commercial purposes (including through the commercial exploitation of the carbon absorption capacity of the forest).		
Consulting room	Means a building or part of a building (not being a hospital) used in the practice of a profession by a medical, veterinary or dental practitioner, or a practitioner in any curative science, in the provision of medical services, mental, moral or family guidance, but does not involve any overnight accommodation other than for animals that are recovering from treatment or in for observation as part of a veterinary practice.		
Cropping	Means propagating, cultivating and/or harvesting of grains, cereals, oilseeds, lupins, legumes, hops, hemp, hay, lucerne or other similar plants or plant products for commercial production.		Commercial forestry; Horticulture; Mushroom production.
Dairy	Means a building or part of a building used for all or any of the operations of commercial milk production (whether mechanical or otherwise) and includes a milking shed, milk room, wash room or engine room.		
Detached dwelling	Means a detached building comprising 1 dwelling on a site that is held exclusively with that dwelling and has a		

Land Use Term (Column A)	Definition (Column B)	Includes (Column C)	Excludes (Column D)
	frontage to a public road, or to a road proposed in a plan of land division that is the subject of a current development authorisation.		
Dwelling	Means a building or part of a building used as a self-contained residence.		
Educational establishment	Means a primary school, secondary school, reception to year 12 school, college, university or technical institute, and includes an associated pre-school or institution for the care and maintenance of children.		
Electricity substation	<p>Means—</p> <p>(a) works for the conversion, transformation or control of electricity by 1 or more transformers, or by any switchgear or other equipment; or</p> <p>(b) any equipment, building, structure or other works ancillary to or associated with works referred to in paragraph (a), other than any such works—</p> <p>(i) that are mounted on a pole; or</p> <p>(ii) that are wholly enclosed in a weather-proof enclosure not exceeding 8.5m³; or</p> <p>(iii) that are incidental to any lawful use of the land which the works are situated.</p>		
Farming	Means cropping, grazing or low intensity animal husbandry.	Cropping; Grazing;	Animal keeping; Commercial forestry; Horse keeping;

Land Use Term (Column A)	Definition (Column B)	Includes (Column C)	Excludes (Column D)
		Low intensity animal husbandry.	Horticulture; Intensive animal husbandry; Mushroom production.
Fuel depot	Means land used primarily for the storage of petrol, gas, oils or other petroleum products and within or upon which no retail trade is conducted.		
General industry	Means any industry other than a light industry or special industry.		
Group dwelling	Means 1 of a group of 2 or more detached buildings, each of which is used as a dwelling and 1 or more of which has a site without a frontage to a public road or to a road proposed in a plan of land division that is the subject of a current development authorisation.		
Horse keeping	Means the keeping or husbandry of horses where more than 1 horse is kept per 3ha of land used for such purposes.		
Horticulture	Means the use of land for market gardening, viticulture, floriculture, orchards, wholesale plant nurseries or commercial turf growing.		Commercial forestry; Mushroom production.
Hotel	Means premises licensed, or proposed to be licensed, as a hotel under the <i>Liquor Licensing Act 1997</i> .		
Indoor recreation facility	Means a building designed or adapted primarily for recreation or fitness pursuits.	Bowling alley; Squash courts; Fitness centre; Gymnasium; Pilates Studio; Yoga Studio; Dance studio; Indoor swimming centre;	

Land Use Term (Column A)	Definition (Column B)	Includes (Column C)	Excludes (Column D)
		Indoor trampoline centre; Indoor rock climbing centre; Indoor children's play centre.	
Industry	<p>Means the carrying on, in the course of a trade or business, of any process (other than a process in the course of farming or mining) for, or incidental to:</p> <p>(a) the making of any article, ship or vessel, or of part of any article, ship or vessel; or</p> <p>(b) the altering, repairing, ornamenting, finishing, assembling, cleaning, washing, packing, bottling, canning or adapting for sale, or the breaking up or demolition, of any article, ship or vessel; or</p> <p>(c) the getting, dressing or treatment of materials</p> <p>The use may include:</p> <p>(d) selling by wholesale of goods manufactured on site</p> <p>(e) selling by retail of goods manufactured on site provided the total floor area occupied for such sale does not exceed 250 square metres</p> <p>(and industrial will be construed accordingly).</p>	General industry; Light industry; Special industry.	
Intensive animal husbandry	Means the commercial production of animals or animal products where the animals are kept in enclosures or other confinement and their main	Broiler shed; Feedlot; Poultry hatchery; Piggery; Poultry battery.	Animal keeping; Apiculture; Aquaculture; Horse keeping;

Land Use Term (Column A)	Definition (Column B)	Includes (Column C)	Excludes (Column D)
	food source is introduced from outside the enclosures or area of confinement in which they are kept.		Low intensity animal husbandry; Stock sales yard.
Landfill	Land used for the receipt and controlled disposal of refuse through burial and/or spreading over land.		
Light industry	<p>Means an industry where the process carried on, the materials and machinery used, the transport of materials, goods or commodities to and from the land on or in which (wholly or in part) the industry is conducted and the scale of the industry does not:</p> <p>(a) detrimentally affect the amenity of the locality or the amenity within the vicinity of the locality by reason of the establishment or the bulk of any building or structure, the emission of noise, vibration, smell, fumes, smoke, vapour, steam, soot, ash, dust, waste water, waste products, grit, oil, spilled light, or otherwise howsoever; or</p> <p>(b) directly or indirectly, cause dangerous or congested traffic conditions in any nearby road.</p>		
Low intensity animal husbandry	Means the commercial production of animals or animal products (eg meat, wool) on either native or improved pastures or vegetation where the animal's main food source is obtained by grazing or foraging.	Grazing;	Animal keeping; Aquaculture; Horse keeping; Intensive animal husbandry.

Land Use Term (Column A)	Definition (Column B)	Includes (Column C)	Excludes (Column D)
Motor repair station	Means any land or building used for carrying out repairs (other than panel beating or spray painting) to motor vehicles and / or farm machinery.		Automotive collision repair
Mushroom production	Means the commercial production of mushrooms or any other type of fungi.		
Office	Means any building used for administration or the practice of a profession.		Consulting room.
Organic waste processing facility	Means the commercial processing of organic waste by composing, mulching, shredding, grinding or similar process into organic material for use as mulch, soil improver, growing medium or the like.		
Outbuilding	Means a non-habitable detached building on the same site as a main building which is ancillary and subordinate to the main building and has a use and function which relates to the main building.		Private bushfire shelter.
Personal or domestic services establishment	<p>Means premises used for the provision of services catering to the personal or domestic needs of customers:</p> <p>Examples— The following are examples of services that may be available at personal and domestic services establishments</p> <ul style="list-style-type: none"> (a) clothing repair and alterations; (b) cutting, trimming and styling hair; (c) domestic pet grooming; (d) manicures and pedicures; 		Consulting room; Office; Financial institute.

Land Use Term (Column A)	Definition (Column B)	Includes (Column C)	Excludes (Column D)
	(e) non-surgical cosmetic treatments; (f) personal care treatments; (g) self-service clothes laundering; (h) shoe repair; (i) watch repair.		
Place of worship	Means premises used by an organised group for worship and religious activities. The use may include facilities for social, educational and charitable activities associated with the congregation.	Chapel; Church; Mosque; Synagogue; Temple.	Funeral parlour.
Pre-school	Means a place primarily for the care or instruction of children of less than primary school age not resident on the site.	Child care centre; Early learning centre; Kindergarten; Nursery.	
Protective tree netting structure	Means netting and any associated structure: (a) that is designed to protect trees or plants grown for the purpose of commercial horticulture; and (b) that consists of a netting canopy attached to a structure (such as poles and cables).		
Public service depot	Means land used for storage and operations connected with the provision of public services (including gas, electricity, water supply, sewerage, drainage, roadworks or telecommunication services) by a body responsible for the provision of those services.		
Recreation area	Means any park, garden, children's playground or sports ground that is under the care, control and	Outdoor public sports courts; Public ovals and fields.	Golf course.

Land Use Term (Column A)	Definition (Column B)	Includes (Column C)	Excludes (Column D)
	management of the Crown, or a council, and is open to the public without payment of a charge.		
Renewable energy facility	<p>Means land and/or water used to generate electricity from a renewable source such as wind, solar, tidal, hydropower, biomass and/or geothermal.</p> <p>This use may also include:</p> <p>(a) any associated facility for the storage and/or transmission of the generated electricity;</p> <p>(b) any building or structure used in connection with the generation of electricity.</p> <p>The use does not include a renewable energy facility principally used to supply and/or store electricity to an existing use of land that has a generating capacity less than 5MW (e.g., domestic solar panels, domestic wind generators, domestic battery storage).</p>	<p>Battery storage facility;</p> <p>Hydropower or pumped hydropower facility;</p> <p>Solar power facility;</p> <p>Wave power generator;</p> <p>Wind farm.</p>	
Residential flat building	Means a single building in which there are 2 or more dwellings.		Group dwelling; Row dwelling; Semi-detached dwelling;
Residential park	Means a residential park operating under the regulatory framework of the <i>Residential Parks Act 2007</i> .		Caravan and tourist park;
Restaurant	Means land used primarily for the consumption of meals on the site.		
Retail fuel outlet	<p>Means land used for:</p> <p>(a) the fuelling of motor vehicles involving the sale by retail of petrol, oil, liquid petroleum</p>		Fuel depot; Motor repair station.

Land Use Term (Column A)	Definition (Column B)	Includes (Column C)	Excludes (Column D)
	<p>gas, automotive distillate and any other fuels; and</p> <p>(b) the sale by retail of food, drinks and other convenience goods for consumption on or off the land; and</p> <p>both are operated as and constitute one integrated facility where on-site facilities, systems and processes, car parking and access and egress are all shared.</p> <p>The use may also include one or more of the following secondary activities:</p> <p>(c) the washing and cleaning of motor vehicles;</p> <p>(d) the washing of other equipment or things including dogs and other pets;</p> <p>(e) the provision (on a paid or free basis) of facilities for charging electric vehicles;</p> <p>(f) the hiring of trailers;</p> <p>(g) selling of motor vehicle accessories and/or parts; and</p> <p>(h) the installation of motor vehicle accessories and/or parts.</p>		
Retirement facility	Means a facility operating under the regulatory framework of the <i>Retirement Villages Act 2016</i> .		
Row dwelling	<p>Means a dwelling:</p> <p>(a) occupying a site that is held exclusively with that dwelling and has a frontage to a public road or to a road proposed in a plan of</p>		

Land Use Term (Column A)	Definition (Column B)	Includes (Column C)	Excludes (Column D)
	<p>land division that is the subject of a current development authorisation; and</p> <p>(b) comprising 1 of 3 or more dwellings erected side by side, joined together and forming, by themselves, a single building.</p>		
Semi-detached dwelling	<p>Means a dwelling:</p> <p>(a) occupying a site that is held exclusively with that dwelling and has a frontage to a public road or to a road proposed in a plan of land division that is the subject of a current planning authorisation; and</p> <p>(b) comprising 1 of 2 dwellings erected side by side, joined together and forming, by themselves, a single building.</p>		
Service trade premises	<p>Means premises used primarily for the sale, rental or display of:</p> <p>(a) basic plant, equipment or machinery used in agriculture or industry; or</p> <p>(b) boats; or</p> <p>(c) caravans and recreational vehicles (RVs); or</p> <p>(d) domestic garages; or</p> <p>(e) sheds; or</p> <p>(f) outbuildings; or</p> <p>(g) motor vehicles; or</p> <p>(h) marquees; or</p> <p>(i) trailers; or</p>	<p>Motor vehicle showroom; Used car yard.</p>	<p>Bulky goods outlet.</p>

Land Use Term (Column A)	Definition (Column B)	Includes (Column C)	Excludes (Column D)
	<p>(j) swimming pools, equipment and accessories; or</p> <p>(k) building materials in bulk supply; or</p> <p>(l) landscaping materials; or</p> <p>(m) garden plants (primarily in an outdoor setting), or</p> <p>(n) agricultural supplies such as agricultural chemicals, fertilisers, seed and animal feed; or</p> <p>(o) rainwater tanks and irrigation supplies;</p> <p>or similar articles or merchandise.</p> <p>The use may also include the servicing and repair of any of the listed items (but not vehicle panel beating or spray painting).</p>		
Shop	<p>Means:</p> <p>(a) premises used primarily for the sale by retail, rental or display of goods, foodstuffs, merchandise or materials; or</p> <p>(b) a personal or domestic services establishment.</p>	<p>Bulky goods outlet;</p> <p>Personal or domestic services establishment;</p> <p>Restaurant.</p>	<p>Hotel;</p> <p>Motor repair station;</p> <p>Retail fuel outlet;</p> <p>Service trade premises;</p> <p>Wholesale plant nursery.</p>
Special industry	<p>Means an industry where the processes carried on, the methods of manufacture adopted or the particular materials or goods used, produced or stored, are likely:</p> <p>(a) to cause or create dust, fumes, vapours, smells or gases; or</p>		

Land Use Term (Column A)	Definition (Column B)	Includes (Column C)	Excludes (Column D)
	<p>(b) to discharge foul liquid or blood or other substance or impurities liable to become foul, and thereby:</p> <p>(c) to endanger, injure or detrimentally affect the life, health or property of any person (other than any person employed or engaged in the industry); or</p> <p>(d) to produce conditions which are, or may become, offensive or repugnant to the occupiers or users of land in the locality of or within the vicinity of the locality of the land on which (whether wholly or partly) the industry is conducted.</p>		
Stock slaughter works	<p>Means a building or part of a building, or land, used primarily for slaughter of stock (including camels, goats and deer) or poultry,</p> <p>This use may also include:</p> <p>(a) the keeping of animals prior to slaughter on site</p> <p>(b) processing of animal products for human or animal consumption.</p>		Retail butcher.
Stock sales yard	<p>Means land or premises used for the commercial conduct of buying and selling of livestock.</p>		Stock slaughter works.
Store	<p>Means a building or enclosed land used for the storage of goods, and within or upon which no trade (whether wholesale or retail) or industry is carried on.</p>		Junk yard; Outbuilding; Public service depot.
Student accommodation	<p>Mean premises used to accommodate students in</p>		Dwelling;

Land Use Term (Column A)	Definition (Column B)	Includes (Column C)	Excludes (Column D)
	<p>room or dormitory style accommodation that is not self-contained and that includes common facilities for shared use by student occupants such as:</p> <ul style="list-style-type: none"> (a) shared cooking facilities and/or the provision of meals; (b) common rooms and recreation areas; (c) shared laundry facilities or a laundry service; or (d) shared bathroom facilities. 		Residential flat building.
Supported accommodation	Means premises in which residential accommodation is provided to persons requiring/together with regular medical and/or personal care assistance.		Hospital; Retirement facility.
Telecommunications facility	Means a facility within the meaning of the <i>Telecommunications Act 1997</i> of the Commonwealth.		
Tourist accommodation	Means premises in which temporary or short-term accommodation is provided to travellers on a commercial basis.		
Warehouse	Means a building or enclosed land used for the storage of goods and the carrying out of commercial transactions involving the sale of such goods, but does not include any land or building used for sale by retail.		Store.
Wind farm	<p>Means land used to generate electricity from wind force with wind turbine generators. This use may also include:</p> <ul style="list-style-type: none"> (a) any associated facility for the storage and/or 		

Land Use Term (Column A)	Definition (Column B)	Includes (Column C)	Excludes (Column D)
	<p>transmission of the generated electricity;</p> <p>(b) any building or structure used in connection with the generation of electricity including a wind turbine, substation, maintenance shed, access road or wind monitoring mast.</p> <p>The use does not include a wind farm principally used to supply and/or store electricity to an existing use of land (e.g., domestic wind generator).</p>		
Workers' accommodation	<p>Means premises used to accommodate workers on a temporary basis while they carry out employment:</p> <p>(a) on the same site as the workers' accommodation;</p> <p>(b) in mining or petroleum extraction;</p> <p>(c) in seasonally intensive rural activities such as fruit picking, pruning, animal shearing, meat processing or similar; or</p> <p>(d) in road and/or railway infrastructure construction.</p>	<p>Mining camp; Road workers camp; Shearing quarters; Railway workers camp;</p>	<p>Tourist accommodation.</p>

Part 8 – Administrative Definitions

The following table lists terms which may be used to assist with the interpretation of policy used in the Planning and Design Code.

Meaning of Terms

A term listed in Column A has the meaning set out beside that term in Column B. Column C contains, where applicable, illustrations to assist with the interpretation of the meaning provided in Column B.

No Definition

A term not defined in the following table will have its ordinary meaning unless the term is defined in the *Planning, Development and Infrastructure Act 2016* or its Regulations (or any relevant practice direction or practice guideline issued by the State Planning Commission) in which case that meaning will apply.

Administrative Definitions Table

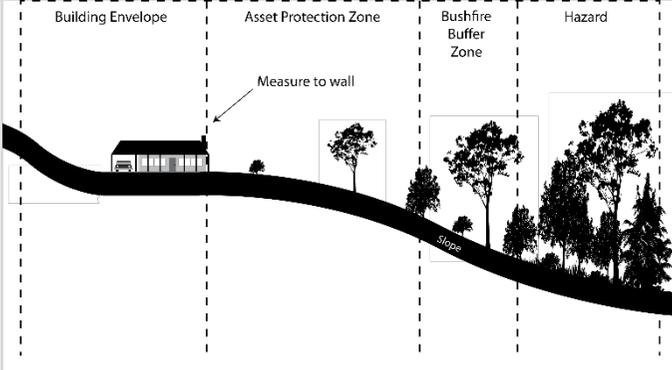
Term (Column A)	Definition (Column B)	Illustrations (Column C)
AEP	Means annual exceedance probability	
AHD	Means Australian height datum.	
Asset protection zone	<p>In relation to bushfire protection, means an area generally clear of vegetation that is maintained to minimise the spread of fire between areas of hazardous vegetation and habitable buildings.</p> <p>Asset protection zones may incorporate features such as driveways, vegetable gardens or landscaped gardens incorporating deciduous trees and fire retardant plant species.</p>	

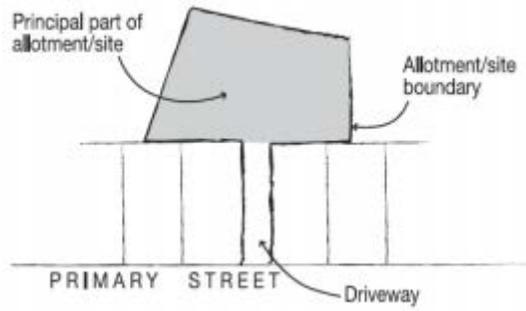
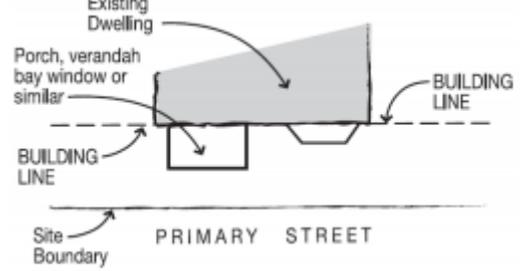
Term (Column A)	Definition (Column B)	Illustrations (Column C)
Battle-axe allotment	<p>Means an allotment or site that comprises—</p> <p>(a) a driveway or 'handle' (and any related open space) that leads back from a road to the balance of the allotment or site; and</p> <p>(b) a balance of the allotment or site that is the principal part of the allotment or site and that does not have a boundary with a road.</p>	 <p>The diagram shows a triangular plot of land, shaded in grey, representing the 'Principal part of allotment/site'. A narrow strip, labeled 'Driveway', connects the plot to a horizontal line representing the 'PRIMARY STREET'. The boundary between the plot and the driveway is labeled 'Allotment/site boundary'.</p> <p><i>Note: Battle-axe allotments are often referred to as 'hammerhead' or 'flagpole' allotments.</i></p>
Building height	<p>Means the maximum vertical distance between the lower of the natural or finished ground level at any point of any part of a building and the finished roof height at its highest point, ignoring any antenna, aerial, chimney, flagpole or the like.</p>	
Building level	<p>Means that portion of a building which is situated between the top of any floor and the top of the next floor above it, and if there is no floor above it, that portion between the top of the floor and the ceiling above it. It does not include a floor located 1.5 metres below finished ground level or any mezzanine.</p>	
Building line	<p>In relation to a building on a site, means a line drawn parallel to the wall on the building closest to the boundary of the site that faces the primary street (and any existing projection from the building such as a carport, verandah, porch or bay window is not to be taken to form part of the building for the purposes of determining the relevant wall of the building).</p>	 <p>The diagram shows a building on a site. The 'Site Boundary' is indicated by a horizontal line. The 'PRIMARY STREET' is shown below the site boundary. A dashed line, labeled 'BUILDING LINE', is drawn parallel to the front wall of the building. The building itself is labeled 'Existing Dwelling'. A 'Porch, verandah bay window or similar' is shown as a projection from the front wall. The 'BUILDING LINE' is shown to be a line drawn parallel to the wall of the building, excluding the porch and other projections.</p>

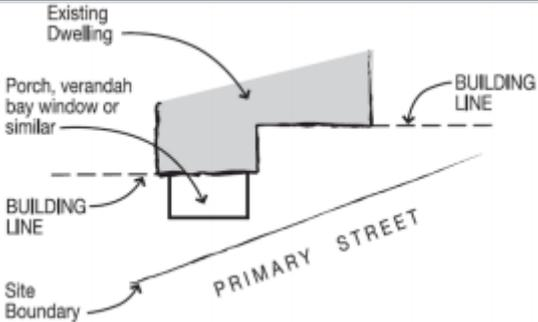
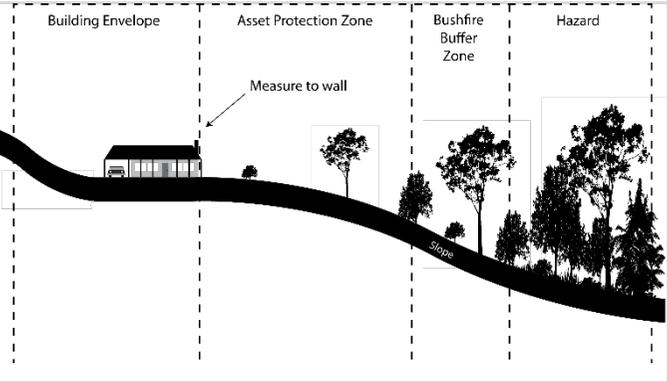
Term (Column A)	Definition (Column B)	Illustrations (Column C)
		 <p>The diagram shows a cross-section of a building on a slope. The building has a main rectangular section and a smaller section below it. Labels include: 'Existing Dwelling' pointing to the main section, 'Porch, verandah bay window or similar' pointing to the smaller section, 'BUILDING LINE' (two dashed lines), and 'Site Boundary' pointing to the ground line. A 'PRIMARY STREET' is shown as a diagonal line below the site boundary.</p>
Bushfire buffer zone	In relation to bushfire protection, means an area of land designed to isolate residential allotments from areas that pose a bushfire risk such as areas with rugged terrain or hazardous vegetation.	 <p>The diagram shows a cross-section of a building on a slope. Vertical dashed lines divide the area into zones: 'Building Envelope' (around the building), 'Asset Protection Zone' (containing a 'Measure to wall'), 'Bushfire Buffer Zone' (containing trees), and 'Hazard' (containing more trees). The slope is labeled 'Slope'.</p>
Defence aviation area	Has the same meaning as in the <i>Defence Act 1903</i> of the Commonwealth.	
Density	In relation to residential development, means the number of dwelling units in a given area. It is calculated by dividing the total number of dwellings by the area of residential land that they occupy (excluding other land uses, roads, public open space, and services).	
FFL	Means finished floor level.	
Gross leasable floor area	Means the total floor area of a building excluding public or common tenancy areas such as malls, hallways, verandahs,	

Term (Column A)	Definition (Column B)	Illustrations (Column C)
	public or shared tenancy toilets, common storage areas and loading docks.	
Groundwater	Means water that is naturally contained beneath the surface of the ground.	
Habitable room	Means any room used for domestic purposes other than a bathroom, laundry, toilet, pantry, walk-in wardrobe, corridor, stair, hallway, lobby, clothes drying room or other space of a specialised nature occupied neither frequently nor for extended periods.	
Heritage agreement	In relation to State Heritage, is an agreement that is registered under section 34 of the <i>Heritage Places Act 1993</i> .	
High-density	Means greater than 70 dwelling units per hectare.	
High-rise	In relation to development, means 7 building levels and above.	
Hours of operation	Means the hours that a land use is open to the public or conducting activities related to the land use, not including administration or routine activities normally associated with opening and closing or start up and shut down.	
Low-density	Means less than 35 dwelling units per hectare.	
Low rise	In relation to development, means up to and including 2 building levels.	
Medium-density	Means 35 to 70 dwelling units per hectare.	
Medium-rise	In relation to development, means 3 to 6 building levels.	
Mezzanine	Means an intermediate floor within a building between building levels that is open to the floor below and does not extend over the whole floor space.	
Native vegetation	Has the same meaning as in the <i>Native Vegetation Act 1991</i> .	

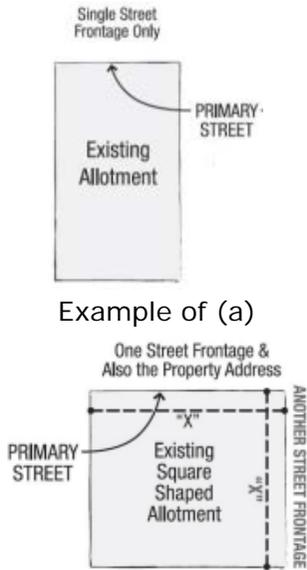
Term (Column A)	Definition (Column B)	Illustrations (Column C)
Neighbourhood zone	Means any of the following: City Living Zone Residential Neighbourhood Zone Residential Parks Zone Rural Living Zone Suburban Neighbourhood Zone Suburban Neighbourhood (Medium Density) Zone Suburban Neighbourhood (Low Density) Zone Suburban Neighbourhood (Master-planned) Zone Suburban Neighbourhood (Greenfield) Zone Urban Renewal Zone	
Non-sensitive use	Means use of land other than sensitive use	
Power system	Has the same meaning as in the <i>Electricity Act 1996</i> .	
Primary street	In relation to an existing or proposed building on a site is— (a) in the case of a site that has a frontage to only 1 road – that road; (b) in the case of a site that has a frontage to 2 roads— (i) if the frontages are identical in length – the road that forms part of the street address of the building, as determined by the council for the relevant area when it is allocating numbers to building and allotments under section 220 of the <i>Local Government Act 1999</i> ; or (ii) in any other case, the road in relation to which the site has a shorter frontage; or (c) in any other case, the road that forms part of the street address of the building, as determined by the council for the relevant area when it is allocated numbers to buildings and allotments under section 220 of the <i>Local Government Act 1999</i> .	 <p>Single Street Frontage Only</p> <p>Existing Allotment</p> <p>PRIMARY STREET</p> <p>Example of (a)</p> <p>One Street Frontage & Also the Property Address</p> <p>Existing Square Shaped Allotment</p> <p>PRIMARY STREET</p> <p>ANOTHER STREET FRONTAGE</p> <p>Example of (b)(i)</p>

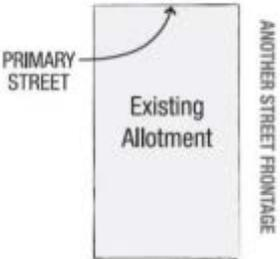
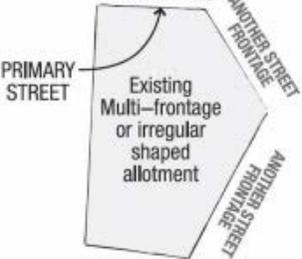
Term (Column A)	Definition (Column B)	Illustrations (Column C)
		<p data-bbox="1646 284 1751 327">One Street Frontage Only</p>  <p data-bbox="1552 395 1608 438">PRIMARY STREET</p> <p data-bbox="1653 438 1742 494">Existing Allotment</p> <p data-bbox="1787 363 1814 582">ANOTHER STREET FRONTAGE</p> <p data-bbox="1552 619 1792 651">Example of (b)(ii)</p> <p data-bbox="1608 667 1736 726">Street Frontage Matching the Property Address</p>  <p data-bbox="1523 794 1590 837">PRIMARY STREET</p> <p data-bbox="1624 805 1747 917">Existing Multi-frontage or irregular shaped allotment</p> <p data-bbox="1736 730 1825 805">ANOTHER STREET FRONTAGE</p> <p data-bbox="1736 877 1814 981">ANOTHER STREET FRONTAGE</p> <p data-bbox="1574 1010 1769 1042">Example of (c)</p>
Private open space	<p data-bbox="490 1066 1232 1098">Means an outdoor area associated with a dwelling that:</p> <ul style="list-style-type: none"> <li data-bbox="490 1117 1209 1177">(a) is for the exclusive use of the occupants of that dwelling; <li data-bbox="490 1197 1187 1228">(b) has a minimum dimension of 1.8 metres; and <li data-bbox="490 1248 840 1279">(c) is not fully enclosed. <p data-bbox="490 1295 1321 1393">Private open space may include balconies, terraces, decks and areas between the dwelling and side boundaries but does not include areas used for bin storage, laundry drying,</p>	

Term (Column A)	Definition (Column B)	Illustrations (Column C)
	rainwater tanks, utilities, driveways and vehicle parking areas.	
Proclaimed shipwreck	Means— (a) a historic shipwreck or historic relic within the meaning of the <i>Historic Shipwrecks Act 1981</i> ; or (b) a historic shipwreck or historic relic within the meaning of the <i>Historic Shipwrecks Act 1976</i> (Commonwealth).	
Secondary street	In relation to a building is any road, other than the primary street, that shares a boundary with the allotment on which the building is situated (or to be situated).	
Sensitive receiver	Means: (a) any use for residential purposes or land zoned primarily for residential purposes; (b) pre-school; (c) educational establishment; (d) hospital; (e) supported accommodation; (f) tourist accommodation.	
Sensitive use	Has the same meaning as in the <i>Environment Protection Act 1993</i> .	
Site	Means the area of land (whether or not comprising a separate or entire allotment) on which a building is built, or proposed to be built, including the curtilage of the building, or in the case of a building comprising more than 1 separate occupancy, the area of land (whether or not comprising a separate or entire allotment) on which each occupancy is built, or proposed to be built, together with its curtilage.	
Soft-landscaping	Means landscaped areas that are pervious and capable of supporting the growth of plant species. It does not include	

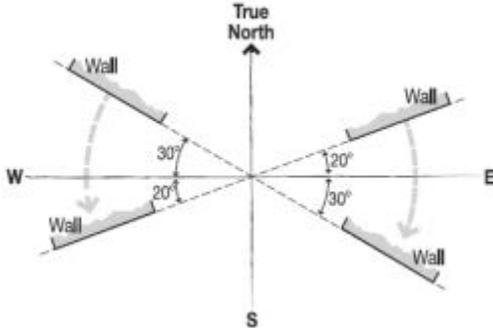
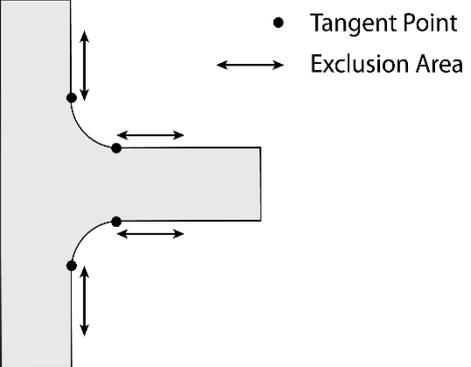
Term (Column A)	Definition (Column B)	Illustrations (Column C)
	any form of pervious paving or paved/hardstand areas used for pedestrian and/or vehicle movement.	
South	Means—true south.	
South facing	In relation to building orientation, a side wall is south facing if the wall is orientated anywhere between E20°N/W20°S and E30°S/W30°N.	 <p data-bbox="1467 766 1870 798">Example of south facing walls.</p>
Standard sea flood risk level	Means the 1% AEP sea flood level (tide, stormwater and associated wave effects combined), plus an allowance to accommodate 100 years of land subsidence.	
Tangent point	Means the end point of a road's curve at the point of intersection.	 <ul style="list-style-type: none"> <li data-bbox="1713 941 1904 965">● Tangent Point <li data-bbox="1657 981 1904 1005">↔ Exclusion Area
Terrace arrangement	Means a group of 3 or more detached dwellings erected side by side and abutting each other but not joined by way of a party wall or party walls.	

Term (Column A)	Definition (Column B)	Illustrations (Column C)
Total floor area	Means the sum of the superficies of horizontal sections of a building or other roofed area made at the level of each floor, inclusive of all roofed areas and of the external walls and of such portions of any party walls as belong to the building.	
Wall height	Means the height of the wall measured from the top of its footings but excluding any part of the wall that is concealed behind an eave or similar roof structure and not visible external to the land.	
Waste	Means waste within the meaning of the <i>Environment Protection Act 1993</i> .	

Part 9 – Referrals

Notes- Additional Referrals

Additional referrals to those specified below are contained within Overlays within the Planning and Design Code

Notes- Additional Referrals

Additional referrals to those specified below are contained within Overlays within the Planning and Design Code

Part 9.1 Referral Body: Environment Protection Authority

In relation to Part 9(1):

Community wastewater management system (CWMS) means a system for the collection and management of wastewater generated in a town, regional or other community.

Liquid waste means waste classified as liquid waste in accordance with the assessment process set out in the guideline Liquid waste classification test, re-issued by the Environment Protection Authority in September 2003; as defined in Schedule 1 of the *Environment Protection Act 1993*.

Listed waste means a substance or thing listed in Part B of Schedule 1 of the *Environment Protection Act 1993*.

Medical waste has the same meaning as in the *Environment Protection (Waste to Resources) Policy 2010*.

Prescribed approved activity – means:

- (a) the on-site storage or disposal of domestic waste;
- (b) a regulated beverage container activity;
- (c) a regulated drop-off station for e-waste;
- (d) the temporary on-site storage of waste (other than tyre waste) while awaiting transport to another place;
- (e) incineration by way of thermal oxidation using fuel burning equipment for the disposal of solid trade waste with a processing capacity not exceeding 100 kilograms per hour;
- (f) the storage or disposal of tyre waste in a manner approved by the Environment Protection Authority;
- (g) the disposal of human wastewater or sewage to land in a manner approved by the Environment Protection Authority.

Quarantine waste means waste that is subject to quarantine under the *Quarantine Act 1908* of the Commonwealth.

River Murray Protection Area means a River Murray Protection Area under the *River Murray Act 2003*.

Treatment is taken to have the same meaning as defined in section 3(1) as in the *Environment Protection Act 1993*.

Waste has the same meaning as in the *Environment Protection Act 1993*.

Wastewater means waste principally consisting of water and includes—

- (a) human wastewater;
- (b) sewage;
- (c) water containing food or beverage waste;
- (d) wash down water or cooling water;
- (e) irrigation runoff or contaminated stormwater;
- (f) water containing any other trade waste or industrial waste;
- (g) any other water that has been used in any form of human activity;
- (h) a combination of any 1 or more of the above.

Water protection area has the same meaning as in the *Environment Protection Act 1993*.

Referral Body: Environment Protection Authority				
Referral Category	Development type	Referral triggers	Policies relevant to the referral	Purpose of referral
Site contamination	Change in use of land to sensitive use or more sensitive use, except where— (a) a <i>site contamination audit report</i> under Part 10A of the <i>Environment Protection Act 1993</i> has, within 5 years of the application, been	A change to a <i>more sensitive use</i> of land (including following its subdivision) at which <i>site contamination</i> exists or may exist as a result of a <i>class 1 potentially contaminating activity</i> listed in a Practice Direction (including <i>site contamination</i> caused by such an activity conducted on <i>adjacent land</i> , or on <i>other land</i> identified	Site Contamination General Development Provisions	To ensure an appropriate and proportionate assessment of potential site contamination by providing direction to the relevant authority on the most

	<p>prepared in relation to the land; and</p> <p>(b) the report clearly states that—</p> <p>(i) <i>site contamination</i> does not exist (or no longer exists) at the land; or</p> <p>(ii) the land is suitable for the proposed use or range of uses (without the need for any further remediation); or</p> <p>(iii) where remediation is or remains necessary for the proposed use (or range of uses), remediation work has been carried out or will be carried out (and the applicant has provided a written undertaking that the remediation works will be implemented as part of the application); and</p> <p>(c) no <i>class 1 or 2 potentially contaminating activities</i> (as identified in a Practice Direction) have taken place at the land since the preparation of the report.</p>	<p>on the SA Planning Portal that is known to impact the subject site).</p> <p>A change from:</p> <p>(a) a <i>non-sensitive use</i> to a <i>sensitive use</i>; or</p> <p>(b) <i>from a sensitive use</i> to a <i>more sensitive use</i></p> <p>on land at which <i>site contamination</i> exists or may exist as a result of a <i>class 2 potentially contaminating activity</i> listed in a Practice Direction (including <i>site contamination</i> caused by such an activity conducted on <i>adjacent land</i>, or on <i>other land</i> identified on the SA Planning Portal that is known to impact the subject site).</p> <p>A change in use of the land (including following its subdivision) that is the subject of a notation under section 103P of the <i>Environment Protection Act 1993</i> (i.e. a site contamination audit report has been prepared in respect of the land) to a <i>more sensitive use</i>.</p>		<p>appropriate person to determine site suitability (ie site contamination consultant or site contamination auditor).</p>
<p>Energy generation and storage facilities</p>	<p>Wind farms</p>	<p>Development that involves the establishment of a wind farm where 1 or more wind turbine generators (whether or not located on the same site) are</p>	<p>Section 57 of <i>Environment Protection Act 1993</i> sets out criteria to be considered by the EPA</p>	<p>To provide expert technical assessment and direction to the relevant authority on the assessment of the</p>

		<p>used to generate electricity that is then supplied to another person for use at another place.</p>		
	<p>Energy recovery from waste</p>	<p>Development involving energy recovery from <i>waste</i>, including <i>anaerobic digestion</i> and thermal activities such as <i>direct combustion</i>, <i>pyrolysis</i> and <i>gasification</i> used to generate gas, heat, electricity or a combination.</p> <p>In this referral trigger:</p> <p><i>anaerobic digestion</i> involves a series of processes in which microorganisms break down biodegradable material to biogas in the absence of oxygen</p> <p><i>direct combustion</i> involves burning in excess oxygen (from air) to produce heat or release energy contained in the fuel</p> <p><i>pyrolysis</i> involves the thermo-chemical decomposition of organic or inorganic material- for example synthetic tyres – at elevated temperatures in the absence of oxygen</p> <p><i>gasification</i> of waste is a process that converts organic or fossilised organic material such as coal, at</p>	<p>in relation to the assessment of development applications. This head power also links to other statutory criteria in the <i>Environment Protection (Air Quality) Policy 2016</i>, <i>Environment Protection (Noise) Policy 2007</i>, <i>Environment Protection (Waste to Resources) Policy 2010</i> and the <i>Environment Protection (Water Quality) Policy 2015</i>.</p>	<p>potential harm from pollution and waste aspects arising from activities of environmental significance and other activities that have the potential to cause serious environmental harm.</p>

		<p>elevated temperatures and with controlled amounts of oxygen, into a synthetic gas (syngas)</p>		
	<p>Energy generation and storage</p>	<p>Development involving an <i>electricity generating plant</i> or <i>energy storage facility</i> (other than a <i>battery storage facility</i>) using any other energy source (excluding <i>fuel burning</i> and solar photovoltaic) with a capacity to generate or store 30 megawatts (MW) or more that is to be connected to the State's <i>power system</i>.</p> <p>In this referral trigger:</p> <p><i>battery storage facility</i> means a facility for the purpose of 1 or more batteries that are capable of being charged, storing energy and discharging in into the State's power system</p> <p><i>electricity generating plant</i> means electricity generating plant within the ambit of paragraph (a) of the definition of electricity infrastructure in section 4(1) of the <i>Electricity Act 1996</i></p>		

		power system has the same meaning as in the <i>Electricity Act 1996</i>		
Petroleum and Chemical	Chemical storage and warehousing facilities	The storage or warehousing of chemicals or chemical products that are, or are to be, stored or kept in bulk or in containers having a capacity exceeding 200 litres at facilities with a total storage capacity exceeding 1,000 cubic metres.		
	Chemical works	The conduct of: (a) works with a total processing capacity exceeding 10 tonnes per year, involving either or both of the following operations: (i) manufacture (through chemical reaction) of any inorganic chemical, including sulphuric acid, inorganic fertilisers, soap, sodium silicate, lime or other calcium compound; (ii) manufacture (through chemical reaction) or processing of any organic chemical or chemical product or petrochemical, including the separation of such materials into different		

		<p>products by distillation or other means; or</p> <p>(b) works with a total processing capacity exceeding 5,000 tonnes per year involving operations for salt production.</p>		
	Coke works	The production, quenching, cutting, crushing and grading of coke.		
	Hydrocarbon storage or production works	<p>The conduct of works or a facility:</p> <p>(a) for the storage of hydrocarbon or hydrocarbon products in tanks that, in aggregate, have a storage capacity exceeding 100m³; or</p> <p>(b) for the production of hydrocarbon or hydrocarbon products, being works having a total capacity exceeding 20 tonnes per hour.</p>		
	Petrol stations	<p>The conduct of a petrol station, being a facility for the storage and retail sale of petroleum products or other liquid organic chemical substances</p> <p>In this referral trigger:</p> <p>petroleum product has the same meaning as in the <i>Petroleum Products Regulation Act 1995</i>.</p>		

	Timber preservation works	The conduct of works for the preservation of timber by chemicals, but excluding the preservation by a primary producer of timber for use in the course of primary production carried on by the producer.		
Manufacturing and Mineral Processing	Abrasive blasting	The cleaning of materials by the abrasive action of any metal shot or mineral particulate propelled in a gaseous or liquid medium (otherwise than solely by using blast cleaning cabinets less than 5m ³ in volume or totally enclosed automatic blast cleaning units).		
	Hot mix asphalt preparation	The conduct of works at which crushed or ground rock aggregates are mixed with bituminous or asphaltic materials (by heating in a furnace, kiln or other fuel fired plant) for the purposes of producing road building mixtures.		
	Cement works	<p>The conduct of works for the use of <i>argillaceous</i> and <i>calcareous</i> materials in the production of cement clinker or the grinding of cement clinker.</p> <p>In this referral trigger:</p> <p><i>argillaceous</i> means having to do with or resembling clay</p>		

		<i>calcareous</i> means having to do with calcium carbonate		
	Ceramic works	The conduct of works for the production of any products such as bricks, tiles, pipes, pottery goods, refractories, or glass that are manufactured or are capable of being manufactured in furnaces or kilns fired by any fuel, being works with a total capacity for the production of such products exceeding 100 tonnes per year.		
	Concrete batching works	The conduct of works for the production of concrete or concrete products that are manufactured or are capable of being manufactured by the mixing of cement, sand, rock, aggregate or other similar materials, being works with a total capacity for production of such products exceeding 0.5m ³ per production cycle.		
	Drum reconditioning or treatment works	The conduct of works for the cleaning, repairing, reconditioning or other treatment of metal or plastic drums or containers for the purposes of their reuse, including any associated storage facility.		

<p>Ferrous and non-ferrous metal melting</p>	<p>the melting of ferrous or non-ferrous metal in a furnace or furnaces that alone or in aggregate have the capacity to melt-</p> <ul style="list-style-type: none"> (a) in excess of 50 but not in excess of 500 kilograms of metal during the normal cycle of operation but excluding facilities more than 500m from residential premises not associated with the works; or (b) in excess of 500 kilograms of metal during the normal cycle of operation. 		
<p>Metallurgical works</p>	<p>The conduct of works at which ores are smelted or reduced to produce metal.</p>		
<p>Mineral works</p>	<p>The conduct of works for processing mineral ores, sands or earths to produce mineral concentrates.</p>		
<p>Pulp or paper works</p>	<p>The conduct of works at which paper pulp or paper is manufactured or is capable of being manufactured, being works with a total capacity for production of such products exceeding 10 tonnes per year</p>		
<p>Surface coating</p>	<p>The conduct of:</p> <ul style="list-style-type: none"> (a) works for metal finishing, in which metal surfaces are prepared or finished by 		

		<p>means of electroplating, electrolyse plating, anodising (chromating, phosphating and colouring), chemical etching or milling, or printed circuit board manufacture, being works producing more than 5 kilolitres per day of effluent; or</p> <p>(b) works for hot dip galvanising; or</p> <p>(c) works for spray painting or powder coating with a capacity to use more than 100 litres per day of paint or 10kg per day of dry powder.</p>		
	Timber processing works	The conduct of works (other than works at a builders supply yard or a home improvement centre) at which timber is sawn, cut, chipped, compressed, milled or machined, being works with a total processing capacity exceeding 4,000m ³ per year.		
	Maritime construction works	The conduct of works for the construction or repair of ships, vessels or floating platforms or structures, being works with the capacity to construct or repair ships, vessels or floating platforms or structures of a mass exceeding 80 tonnes.		
	Vehicle production	The conduct of works for the production of motor vehicles,		

		being works with a production capacity exceeding 2,000 motor vehicles per year.		
	Fibre-reinforced plastic manufacturing	The conduct of facilities for the purposes of manufacturing fibre-reinforced plastic products, but excluding facilities more than 300m from residential premises not associated with the facility.		
Resource recovery, waste disposal and related activities	Waste recovery (<i>excluding a prescribed approved activity</i>)			
	Waste recovery facility	The conduct of a <i>waste recovery facility</i> , being a depot, works or facility (including, but not limited to, a transfer station or material recovery facility) that, during a 12 month period, receives for <i>preliminary treatment</i> , or has the capacity for the <i>preliminary treatment</i> of: (a) more than 100 tonnes of solid waste or matter; or (b) more than 100 kilolitres of liquid waste or matter, prior to its transfer elsewhere for lawful reuse, further treatment or disposal but excluding a prescribed approved activity or an activity in respect of which the Environment Protection Authority is satisfied, having regard to prescribed factors, that a referral is not necessary and has provided		

		<p>written confirmation of this to the relevant authority.</p> <p>In this referral trigger:</p> <p><i>preliminary treatment</i> of waste or matter, includes sorting, aggregating, compacting, baling or packaging the waste or matter as defined in Schedule 1 of the <i>Environment Protection Act 1993</i>.</p>		
<p>Waste reprocessing (<i>excluding a prescribed approved activity</i>)</p>				
	<p>Composting works</p>	<p>Being a depot, facility or works with the capacity to treat, during a 12 month period-</p> <p>(a) in the case of works located wholly or partly within a water protection area - more than 200 tonnes of organic waste or matter; or</p> <p>(b) in the case of works located wholly outside of a water protection area - more than 1,000 tonnes of organic waste or matter, for the production of compost, but excluding an activity in respect of which the Environment Protection Authority is satisfied, having regard to the prescribed factors, that a referral is not necessary and has provided</p>		

		written confirmation of this to the relevant authority.		
	Scrap metal treatment works	Being a depot, facility or works for the treatment of scrap metal (by processes involving electrically heated furnaces or other fuel burning equipment or by mechanical processes), but excluding an activity in respect of which the Environment Protection Authority is satisfied, having regard to the prescribed factors, that a referral is not necessary and has provided written confirmation of this to the relevant authority.		
	Tyre waste treatment works	<p>Being a depot, facility or works with the capacity to treat more than 5 tonnes of <i>tyre waste</i> during a 12 month period, but excluding an activity in respect of which the Environment Protection Authority is satisfied, having regard to the prescribed factors, that a referral is not necessary and has provided written confirmation of this to the relevant authority.</p> <p>In this referral trigger:</p> <p><i>tyre waste</i> means waste comprised of tyres or tyre pieces as defined in Schedule 1 of the <i>Environment Protection Act 1993</i>.</p>		

	<p>Waste lead acid battery treatment works</p>	<p>Being a depot, facility or works with the capacity to treat more than 500 waste lead acid batteries during a 12 month period, but excluding an activity in respect of which the Environment Protection Authority is satisfied, having regard to the prescribed factors, that a referral is not necessary and has provided written confirmation of this to the relevant authority.</p>		
	<p>Waste reprocessing facility</p>	<p>Being a depot, works or facility other than a depot, works or facility specified in a preceding paragraph) that, during a 12 month period, receives or has the capacity to treat:</p> <ul style="list-style-type: none"> (a) more than 100 tonnes of solid waste or matter; or (b) more than 100 kilolitres of liquid waste or matter, for the production of energy or materials that are ready for use (without requiring further treatment), but excluding an activity in respect of which the Environment Protection Authority is satisfied, having regard to the prescribed factors, that a referral is not necessary and has provided written confirmation of this to the relevant authority. 		

<i>Waste disposal (excluding a prescribed approved activity)</i>			
Landfill depot	Being a depot, facility or works for the disposal of waste to land, but excluding an activity in respect of which the Environment Protection Authority is satisfied, having regard to the prescribed factors, that a referral is not necessary and has provided written confirmation of this to the relevant authority.		
Liquid waste depot	Being a depot, facility or works for the reception and disposal of liquid waste, or the reception, treatment and disposal of liquid waste, but excluding an activity in respect of which the Environment Protection Authority is satisfied, having regard to the prescribed factors, that a referral is not necessary and has provided written confirmation of this to the relevant authority.		
Incineration depot	Being a depot, facility or works for the disposal, by incineration, pyrolysis or gasification by high temperature chemical decomposition, or thermal oxidation using fuel burning equipment, of solid waste, a listed waste or quarantine waste, but excluding:		

		<p>(a) facilities with a processing capacity not exceeding 100 kilograms per hour and more than 500m from residential premises not associated with the facility, or</p> <p>(b) an activity in respect of which the Environment Protection Authority is satisfied, having regard to the prescribed factors, that a referral is not necessary and has provided written confirmation of this to the relevant authority.</p>		
	Wastewater treatment			
	Wastewater treatment works	<p>Being sewage treatment works, a <i>CWMS</i>, winery wastewater treatment works or any other wastewater treatment works with the capacity to treat, during a 12 month period-</p> <p>(a) in the case of works located wholly or partly within a water protection area - more than 2.5 ML of wastewater;</p> <p>or</p> <p>(b) in the case of works located wholly outside of a water protection area - more than 12.5 ML of wastewater</p> <p>but excluding an activity in respect of which the Environment Protection Authority is satisfied, having regard to the prescribed factors, that a referral is not</p>		

		<p>necessary and has provided written confirmation of this to the relevant authority.</p>		
	<p>Activities involving listed wastes</p>			
	<p>Activity producing listed waste</p>	<p>the conduct of an activity in which a <i>listed waste</i> is produced as waste or becomes waste, but excluding the following:</p> <ul style="list-style-type: none"> (a) a domestic activity; (b) retail pharmacy; (c) medical practice (other than the practice of pathology); (d) nursing practice; (e) dental practice; (f) veterinary practice; (g) the conduct of a nursing home or other residential aged care facility; (h) the conduct of an immunisation clinic; (i) the conduct of a hospital with capacity of fewer than 40 beds; or (j) a <i>prescribed industrial activity</i>; (k) an activity in which the waste produced is lawfully disposed of to a sewer; (l) an activity in respect of which the Environment Protection Authority is satisfied, having regard to the prescribed factors, that a referral is not necessary and has provided written confirmation of this to the relevant authority. 		

		<p>In this referral trigger:</p> <p><i>prescribed industrial activity</i>— means:</p> <ul style="list-style-type: none">(a) building work;(b) carpentry or joinery;(c) film processing;(d) plumbing or gas fitting;(e) dry cleaning;(f) primary or secondary school education;(g) agriculture or horticulture;(h) french polishing;(i) manufacturing jewellery;(j) painting or decorating;(k) panel beating and associated spray painting;(l) an activity that results in the production of less than 50 000 litres of waste oil per year;(m) an activity authorised by a lease or licence under the <i>Mining Act 1971</i>, the <i>Petroleum and Geothermal Energy Act 2000</i> or the <i>Roxby Downs (Indenture Ratification) Act 1982</i> where the waste is lawfully disposed of to land and contained within the area of the lease or licence;(n) an activity authorised by a lease under the <i>Mining Act 1971</i> where the waste is lawfully disposed of to land and contained within the area of a miscellaneous purposes		
--	--	---	--	--

		<p>licence under that Act adjacent to the area of the lease.</p>		
	<p>Reception or storage of listed waste</p>	<p>The conduct of a depot, facility or works for the reception or storage of a <i>listed waste</i>, but excluding the following:</p> <ul style="list-style-type: none"> (a) the temporary on-site storage of such waste while awaiting transport to another place; (b) an activity consisting only of storing or distributing goods, in respect of which the Environment Protection Authority is satisfied, having regard to prescribed factors, that a referral is not necessary and has provided written confirmation of this to the relevant authority; (c) the reception or storage by a council or hospital of medical waste produced in the course of a prescribed medical activity; (d) the reception or storage by a retail pharmacy of personal sharps waste, <i>pharmaceutical waste</i> or other medical waste, in connection with a return system for such waste. <p>In this referral trigger:</p> <p><i>personal sharps waste</i> means medical sharps that have been</p>		

		<p>used in a domestic situation for medical purposes;</p> <p>pharmaceutical waste means waste comprised of medicines or other pharmaceutical products;</p> <p>prescribed medical activity— means:</p> <ul style="list-style-type: none"> (a) a medical practice other than— <ul style="list-style-type: none"> (i) medical practice at a hospital; or (ii) the practice of pathology; (b) nursing practice other than at a hospital; (c) dental practice other than at a hospital; (d) operating a nursing home; or (e) veterinary practice; (f) operating a hospital with a capacity of less than 40 beds; (g) operating an immunisation clinic. 		
	<p>Treatment of listed waste</p>	<p>The conduct of a depot, facility or works for the treatment of a <i>listed waste</i>, or <i>wastewater</i> containing a listed waste, by immobilising, stabilising or sterilising the waste by any process (before its further treatment or disposal), but excluding an activity in respect of which the Environment Protection Authority is satisfied, having regard to the prescribed factors</p>		

		that a referral is not necessary and has provided written confirmation of this to the relevant authority.		
Activities in Specified Areas	Brukung Mine Site	The management of the abandoned Brukung mine site and associated acid neutralisation plant situated adjacent to Dawesley Creek in the Mount Lofty Ranges.		
	Discharge of stormwater to underground aquifer	Discharge of stormwater from a catchment area exceeding 1 hectare to an underground aquifer by way of a well or other direct means where the stormwater drains to the aquifer from- (a) land or premises on which a business is carried on in the council area of the City of Mount Gambier; or (b) a stormwater drainage system in the council area of the City of Mount Gambier; or (c) a stormwater drainage system in Metropolitan Adelaide.		
Animal husbandry, Aquaculture and other activities	Feedlots	carrying on an operation for holding in A confined yard or area and feeding principally by mechanical means or by hand- (a) not less than an average of 500 cattle, or 4,000 sheep or		

		<p>goats per day over any period of 12 months; or</p> <p>(b) where the yard or area is situated in a water protection area - not less than an average of 200 cattle, or 1,600 sheep or goats per day over any period of 12 months,</p> <p>but excluding any such operation carried on at an abattoir, slaughterhouse or saleyard or for the purpose only of drought or other emergency feeding.</p>		
	<p>Aquaculture or Fish Farming</p>	<p>The land based propagation or rearing of marine, estuarine or fresh water fish or other marine or freshwater organisms that involves the discharge of wastewater into marine or inland waters, or onto land but excluding where wastewater is discharged to an approved wastewater management system.</p>		
	<p>Saleyards</p>	<p>The commercial conduct of yards at which cattle, sheep or other animals are gathered or confined for the purpose of their sale, auction or exchange, including associated transport loading facilities, being yards with a throughput exceeding 50,000 sheep equivalent units per year [sheep equivalent units: 1 sheep</p>		

		<p>or goat = 1 unit, 1 pig (< 40kg) = 1 unit, 1 pig (> 40kg) = 4 units, 1 cattle (< 40kg) = 3 units, 1 cattle (40—400kg) = 6 units, 1 cattle (> 400kg) = 8 units].</p>		
	<p>Piggeries</p>	<p>The conduct of a piggery (being premises having confined or roofed structures for keeping pigs) with a capacity of-</p> <p>(a) in the case of a piggery located wholly outside of a water protection area- 1,300 or more standard pig units; or</p> <p>(b) in the case of a piggery located wholly or partly within a <i>water protection area</i>- 130 or more standard pig units.</p> <p>In this referral trigger:</p> <p>standard pig units is a unit of measurement of pigs determined-</p> <p>(a) by reference to clause 4.3 of the <i>National Environmental Guidelines for Piggeries 2010</i> (second edition (revised)) prepared by Australian Pork Limited; or</p> <p>(b) in a manner approved by the Environment Protection Authority and published on a website determined by the Environment Protection Authority.</p>		

	Poultry farms	The keeping of poultry in confined or roofed structure(s) exceeding 1,000m ² .		
	Dairies	Carrying on of a dairy with a total processing capacity exceeding more than 100 milking animals at any 1 time in a <i>water protection area</i> .		
Food production and animal and plant product processing	Meat processing works	The conduct of slaughtering works for commercial purposes for the production of meat or meat products for human or animal consumption, being works- (a) in the case of poultry or poultry meat products at a rate of production exceeding 100 tonnes per year; or (b) in the case of any other animal meat or animal meat production at a rate of production exceeding 50 tonnes per year.		
	Breweries and cideries	The conduct of works for the production of beer, cider or any other alcoholic beverage (excluding wine and spirits) by infusion, boiling or fermentation, being works with a production capacity exceeding 5,000 litres per day.		

Fish processing	<p>The conduct of works for scaling, gilling, gutting, filleting, freezing, chilling, packing or otherwise processing fish (as defined in the <i>Fisheries Management Act 2007</i>) for sale, but excluding:</p> <ul style="list-style-type: none"> (a) works with a processing output of less than 100 tonnes per year where wastewater is disposed of to a sewer or CWMS; or (b) works with a processing output of less than 2 tonnes per year where wastewater is disposed of otherwise than to a sewer or CWMS; or (c) processing of fish only in the course of a business of selling fish by retail. 		
Milk processing works	<p>The conduct of works at which milk is separated, evaporated or otherwise processed for the manufacture of evaporated or condensed milk, cheese, butter, ice cream or other similar dairy products, being works at which milk is processed at a rate exceeding 5ML per year.</p>		
Produce processing works	<p>The conduct of works for processing any agricultural crop material being:</p> <ul style="list-style-type: none"> (a) works for the processing of agricultural crop material by deep fat frying, roasting or drying through the 		

		<p>application of heat with a processing capacity exceeding 30kg per hour, or;</p> <p>(b) works at which more than 10ML of wastewater is generated per year and disposed of otherwise than to a sewer or CWMS.</p>		
	Rendering and fat extraction works	The conduct of works at which animal, fish or grease trap wastes or other matter is processed or is capable of being processed by rendering or extraction or by some other means to produce tallow or fat or their derivatives or proteinaceous matter, being works with a total processing capacity exceeding 25 kg per hour.		
	Curing or drying works	<p>the conduct of works at which meat, fish or other edible products are smoked, dried or cured by the application of heat or smoke:</p> <p>(a) with a total processing capacity exceeding 25 but not exceeding 250kg per hour excluding works more than 200m from residential premises not associated with the works; or</p> <p>(b) with a total processing capacity exceeding 250kg per hour.</p>		

	Tanneries or fellmongeries	The conduct of works for the commercial preservation or treatment of animal skins or hides being works processing more than 5 tonnes of skins or hides per year, but excluding- (a) the processing of skins or hides by primary producers in the course of primary production activities outside township areas; or (b) the processing of skins or hides in the course of taxidermy.		
	Woolscouring or wool carbonising works	The conduct of works for the commercial cleaning or carbonising of wool, but excluding cleaning or carbonising of wool in the course of handicraft activities where the wool is further processed for sale by retail.		
	Wineries or Distilleries	The conduct of works for the processing of grapes or other produce to make wine or spirits, being works at which more than 50 tonnes of grapes or other produce are processed per year; but excluding—works for bottling only.		
Materials handling and transportation	Bulk shipping facilities	The conduct of facilities for bulk handling of agricultural crop products, rock, ores, minerals, petroleum products or chemicals		

		<p>to or from any wharf or wharf side facility (including sea-port grain terminals), being facilities handling or capable of handling these materials into or from vessels at a rate:</p> <p>(a) exceeding 10 but not exceeding 100 tonnes per day—excluding facilities more than 300m from residential premises not associated with the facility; or</p> <p>(b) exceeding 100 tonnes per day.</p>		
	Bulk storage	<p>The conduct of facilities for bulk handling of agricultural crop products, rock, ores, minerals, petroleum products or chemicals to or from any commercial storage facility at a rate exceeding 100 tonnes per day—excluding facilities more than 300m from residential premises not associated with the facility.</p>		
	Railway operations	<p>The conduct of any of the following activities associated with a railway:</p> <p>(a) the construction or operation of rail infrastructure; and</p> <p>(b) the operation of rolling stock on a railway;</p> <p>(c) other activities conducted on railway land,</p> <p>(d) but excluding—</p> <p>(e) any activities associated with:</p>		

		<ul style="list-style-type: none">(i) a railway with a track gauge that is less than 600mm; or(ii) a railway in a mine which is underground or predominantly underground and used in connection with the performance of mining operations; or(iii) a slipway; or(iv) a crane-type runway; or(v) a railway used solely for the purposes of horse-drawn trams; or(vi) a railway used solely for the purposes of static displays; or(vii) a railway at an amusement park used solely for the purposes of an amusement structure or(viii) the transfer of freight into or onto, and unloading of freight from, rolling stock <p>(f) an activity in respect of which the Environment Protection Authority is satisfied, having regard to the prescribed factors, that a referral is not necessary and has provided written confirmation of this to the relevant authority.</p> <p>In this referral trigger:</p>		
--	--	---	--	--

		<p>rail infrastructure means infrastructure associated with the operation of a railway and includes (but is not limited to) railway track, associated track structures, over or under track structures, supports, tunnels, bridges, stations, platforms, train control systems, signalling systems, communication systems, electric traction infrastructure and buildings, but does not include any workshop or repair facility;</p> <p>railway means a guided system designed for the movement of rolling stock which has the capability of transporting passengers, freight or both on a railway track, together with its infrastructure and associated sidings or crossing, or passing loops, and includes a railway in a marshalling yard or a passenger or freight terminal;</p> <p>railway land means—</p> <ul style="list-style-type: none">(a) land within a rail corridor or rail reserve, including any associated sidings; and(b) railway yards; and(c) other land over which a railway track passes; <p>rolling stock means a vehicle (whether or not self-propelled) that operates on or uses a railway track, but does not include a</p>		
--	--	--	--	--

		<p>vehicle designed to operate both on and off a railway track when the vehicle is not operating on a railway track.</p> <p>Examples—A locomotive, carriage, rail car, rail motor, light rail vehicle, train, tram, light inspection vehicle, road/rail vehicle, trolley, wagon.</p>		
	<p>Crushing, grinding or milling</p>	<p>Processing (by crushing, grinding, milling or separating into different sizes by sieving, air elutriation or in any other manner) of-</p> <p>(a) chemicals or rubber at a rate:</p> <ul style="list-style-type: none"> (i) in excess of 1 but not in excess of 100 tonnes per year excluding facilities more than 500m from residential premises not associated with the facility; or (ii) in excess of 100 tonnes per year; or <p>(b) agricultural crop products at a rate:</p> <ul style="list-style-type: none"> (i) in excess of 50 but not in excess of 500 tonnes per year, but excluding facilities more than 300m from residential premises not associated with the facility; or (ii) in excess of 500 tonnes per year; 		

		<p>but excluding non-commercial processing for on farm use; or</p> <p>(c) rock, ores or minerals at a rate:</p> <p>(i) in excess of 100 but not in excess of 1,000 tonnes per year, but excluding facilities more than 500m from residential premises not associated with the facility; or</p> <p>(ii) in excess of 1,000 tonnes per year;</p> <p>but excluding processing of wet sand.</p>		
	<p>Dredging</p>	<p>The conduct of capital dredging being: the excavation of more than 10m³ of material from the bed of any marine or inland waters by any digging, cutting, suction or any other means and any associated disposal of dredged material to land or waters, but excluding:</p> <p>(a) maintenance dredging;</p> <p>(b) works associated with the establishment of a visual aid; or</p> <p>(c) any lawful fishing or recreational activity.</p> <p>In this referral trigger:</p>		

		<p>marine waters has the same meaning as in Section 3 of <i>Environment Protection Act 1993</i>.</p> <p>maintenance dredging means the excavation of material from the bed of any marine or inland waters by any digging, cutting, suction or any other means for the purpose of maintaining a previously dredged (approved) depth, width and area in marine or inland waters.</p>		
	Coal handling and storage	The handling of coal or carbonaceous material by any means or the storage of coal, coke or carbonaceous reject material at facilities with a total handling capacity exceeding 100 tonnes per day or a storage capacity exceeding 5,000 tonnes.		
	Extractive industries	The conduct of operations involving extraction, or extraction and processing (by crushing, grinding, milling or separating into different sizes by sieving, air elutriation or any other manner), of sand, gravel, stone, shell, shale, clay or soil, being operations with an extraction production rate exceeding 100,000 tonnes per year.		

Other	Aerodromes	<p>The conduct of facilities for commercial or charter aircraft take-off and landing, being facilities estimated to be used for:</p> <ul style="list-style-type: none"> (a) more than 200 flight movements per year but excluding facilities more than 3km from residential premises not associated with the facilities; or (b) more than 2 000 flight movements per year in any case. 		
	Fuel burning	<p>The conduct of works or facilities involving the use of fuel burning equipment, including flaring (other than flaring at hydrocarbon storage or production works that do not have a total storage capacity or total production rate exceeding the levels respectively specified in 'Hydrocarbon storage or production works') or incineration, where the equipment alone or in aggregate is capable of burning combustible matter-</p> <ul style="list-style-type: none"> (a) a rate of heat release exceeding 5MW; or (b) at a rate of heat release exceeding 500KW and the products of combustion are used: <ul style="list-style-type: none"> (i) to stove enamel; or (ii) to bake or dry any substance that on heating releases dust or air impurities. 		

<p>Helicopter landing facilities</p>	<p>The conduct of facilities designed for the arrival and departure of helicopters, but excluding:</p> <ul style="list-style-type: none"> (a) facilities that are situated more than 3km from residential premises not associated with the facilities; or (b) facilities at the site of an activity authorised under the <i>Mining Act 1971</i>, the <i>Petroleum and Geothermal Energy Act 2000</i>, the <i>Petroleum (Submerged Lands) Act 1982</i> or the <i>Roxby Downs (Indenture Ratification) Act 1982</i>. 		
<p>Marinas and boating facilities</p>	<p>The conduct of facilities comprising pontoons, jetties, piers or other structures (whether on water or land) designed or used to provide moorings or dry storage for:</p> <ul style="list-style-type: none"> (a) 50 or more powered vessels at any 1 time; or (b) works for the repair or maintenance of vessels with the capacity to handle 5 or more vessels at any one time or vessels 12m or more in length. 		
<p>Motor racing or testing venues</p>	<p>The conduct of facilities designed and used for motor vehicle competitions or motor vehicle speed or performance trials, but</p>		

		excluding facilities that are situated more than 3km from residential premises not associated with the facilities.		
	Shooting ranges	The conduct of facilities for shooting competitions, practice or instruction (being shooting involving the propulsion of projectiles by means of explosion), but excluding facilities that are situated more than 3km from residential premises not associated with the facilities.		
	Desalination plants	The conduct of a desalination plant that has a production capacity exceeding 200 kilolitres of desalinated water per day, and includes- (a) an underground desalination plant; and (b) a number of underground desalination plants within any 1 square kilometre area that, in aggregate, have a production capacity exceeding 200 kilolitres of desalinated water per day, but does not include- (c) a plant that disposes of all of its wastewater to a wastewater management system that is the subject of a licence; or		

		<p>(d) a plant that produces 2 megalitres or less of wastewater per year;</p> <p>In this referral trigger:</p> <p>underground desalination plant means a plant having a system comprised of a borehole, submersible pump and associated equipment for the desalination below the ground of underground water;</p> <p>underground water means water occurring naturally under the ground or introduced to an aquifer or other area under the ground.</p>		
	<p>Discharges to marine or inland waters</p>	<p>The conduct of operations, other than a desalination plant referred to in this table), involving discharges into marine waters or inland waters where-</p> <p>(a) the discharges:</p> <ul style="list-style-type: none"> (i) raise the temperature of the receiving waters by more than 2 degrees Celsius at any time at a distance of 10m or more from the point of discharge; or (ii) contain antibiotic or chemical water treatments; and 		

		(b) the total volume of the discharges exceeds 50kl per day.		
	Saline water discharge	An activity involving the discharge to land, surface water or underground water of more than 0.5MI of water per day containing more than 1 500mg of total dissolved solids per litre.		
	Cremation or incineration of human or animal remains	<p>The conduct of a facility for the cremation or incineration of human or animal remains by means of thermal oxidation using fuel burning equipment.</p> <p>In this referral trigger:</p> <p>human or animal remains does not include-</p> <p>(a) medical waste; or (b) cytotoxic wastes; or (c) quarantine waste</p> <p>Cytotoxic wastes means waste that is toxic to living things.</p>		
	Land Division	Land division creating 1 or more additional allotments for residential purposes within 500 metres of land used as a landfill waste depot.		To provide expert technical assessment and advice to the relevant authority on the appropriateness of further residential opportunities being

				established within close proximity to landfill waste depots, due to potential health and safety impacts.
--	--	--	--	--

Part 9.2 Referral Body: The Minister responsible for the administration of the Natural Resources Management Act 2004

Referral Body: The Minister responsible for the administration of the Natural Resources Management Act 2004

Referral Category	Development Type	Purpose of referral
Dams	<p>Except where located within the River Murray Protection Area Overlay, development comprising the erection, construction, modification, enlargement or removal of a dam, wall or other structure that will collect or divert, or collects or diverts water:</p> <p>(a) flowing in a watercourse that is not in the Mount Lofty Ranges Catchment (Area 1) Overlay or Mount Lofty Ranges Catchment (Area 2), and</p> <p>(b) that is not prescribed or flowing over any other land that is not in a Prescribed Surface Water Area Overlay or in the Mount Lofty Ranges Water Protection Area Overlay,</p> <p>and where it is contrary to a Natural Resources Management Plan applying in the region of the development site.</p>	To provide expert assessment and direction to the relevant authority on potential impacts from development on the health, sustainability and/or natural flow paths of water resources.
Commercial Forestry	Development that involves a change in use of land for the purposes of undertaking commercial forestry for which a permit would be required	To provide expert assessment and direction to the relevant authority on potential

Referral Body: The Minister responsible for the administration of the Natural Resources Management Act 2004

Referral Category	Development Type	Purpose of referral
	under section 127(3) of the <i>Natural Resources Management Act 2004</i>	impacts from such development on water resources.

Part 9.3 Referral Body: Technical Regulator

Referral Body: Technical Regulator

Referral Category	Development Type	Purpose of referral
Building Near Powerlines	Development that involves the construction of a building where a declaration has not been given under Schedule 8 -11 of the <i>Planning, Development and Infrastructure Regulations 2019</i> , other than where the development is a building that is intended only to house, or that constitutes, electricity infrastructure (within the meaning of the <i>Electricity Act 1996</i>) or is limited to: (a) an internal alteration of a building; or (b) an alteration to the walls of a building but not so as to alter the shape of the building.	To provide expert technical assessment and direction to the relevant authority on: <ul style="list-style-type: none"> • potential impacts of development on electricity infrastructure; and • potential safety issues relating to development in close proximity to electricity infrastructure.

Part 9.4 Referral Body: Minister for the time being administering the Aquaculture Act 2001

Referral Body: Minister for the time being administering the <i>Aquaculture Act 2001</i>		
Referral Category	Development Type	Purpose of referral
Aquaculture Development	Aquaculture development, other than development which involves an alteration to an existing or approved development which in the opinion of the relevant authority is minor in nature.	To provide expert technical assessment and direction to the relevant authority on matters which may impact upon the associated license required for aquaculture development under the <i>Aquaculture Act 2001</i> .

Part 10 – Table of Amendments

Table of amendments

Nil